

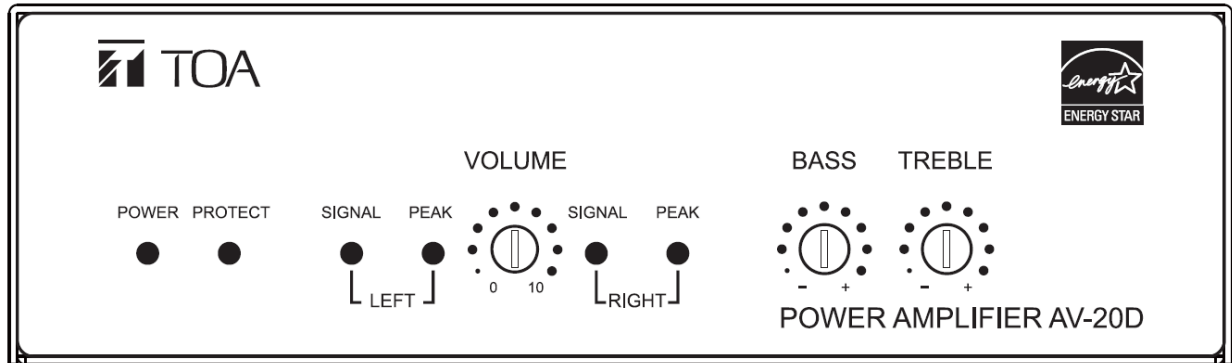

## OPERATING INSTRUCTIONS

# POWER AMPLIFIER

# AV-20D



### TABLE OF CONTENTS

<b>1. IMPORTANT SAFETY INSTRUCTIONS</b>	P2	<b>7. OPERATION</b>	P10
<b>2. SAFETY PRECAUTIONS</b>	P3	<b>8. INSTALLATION PRECAUTIONS</b>	P10
<b>3. GENERAL DESCRIPTIONS</b>	P5	<b>9. ADJUSTMENT</b>	P10
<b>4. FEATURES</b>	P5	9.1. Input Sensitivity Selection	P10
<b>5. NOMENCLATURE AND FUNCTIONS</b>	P5	9.2. Output Volume Setting	P10
Front	P5	<b>10. BLOCK DIAGRAM</b>	P11
Rear	P6	<b>11. DIMENSIONAL DIAGRAM</b>	P12
<b>6. CONNECTIONS</b>	P8	<b>12. SPECIFICATIONS</b>	P13
6.1. Removable Terminal Plug Connection	P8	<b>13. APPENDIX</b>	P14
6.2. Input Connections	P8		
6.3. Speaker Connections	P9		
6.4. Remote Volume Connection	P9		
6.5. AC Power Connections	P9		

Thank you for purchasing TOA's Power Amplifier.

Please carefully follow the instructions in this manual to ensure long, trouble-free use of your equipment.

# 1. IMPORTANT SAFETY INSTRUCTIONS

- Read these instructions.
- Keep these instructions.
- Heed all warnings.
- Follow all instructions.
- Do not use this apparatus near water.
- Clean only with dry cloth.
- Install in accordance with the manufacturer's instructions.
- Do not install near any heat sources such as radiators, heat registers, stoves, or other apparatus (including amplifiers) that produce heat.
- Do not defeat the safety purpose of the polarized or grounding-type plug. A polarized plug has two blades with one wider than the other. A grounding type plug has two blades and a third grounding prong. The wide blade or the third prong are provided for your safety. If the provided plug does not fit into your outlet, consult an electrician for replacement of the obsolete outlet.
- Protect the power cord from being walked on or pinched particularly at plugs, convenience receptacles, and the point where they exit from the apparatus.
- Only use attachments/accessories specified by the manufacturer.
- Use only with the cart, stand, tripod, bracket, or table specified by the manufacturer, or sold with the apparatus. When a cart is used, use caution when moving the cart/apparatus combination to avoid injury from tip-over.



- Unplug this apparatus during lightning storms or when unused for long periods of time.
- Refer all servicing to qualified service personnel. Servicing is required when the apparatus has been damaged in any way, such as power-supply cord or plug is damaged, liquid has been spilled or objects have fallen into the apparatus, the apparatus has been exposed to rain or moisture, does not operate normally, or has been dropped.

## 2. SAFETY PRECAUTIONS

- Before installation or use, be sure to carefully read all the instructions in this section for correct and safe operation.
- Be sure to follow all the precautionary instructions in this section, which contain important warnings and/or cautions regarding safety.
- After reading, keep this manual handy for future reference.

### Safety Symbol and Message Conventions

Safety symbols and messages described below are used in this manual to prevent bodily injury and property damage which could result from mishandling. Before operating your product, read this manual first and understand the safety symbols and messages so you are thoroughly aware of the potential safety hazards.



The exclamation point within an equilateral triangle is intended to alert the user to the presence of important operation and maintenance (servicing) instruction in the literature accompanying the appliance.



### **WARNING**

Indicates a potentially hazardous situation which, if mishandled, could result in death or serious personal injury.

#### When Installing the Unit

- Do not expose the unit to rain or an environment where it may be splashed by water or other liquids, as doing so may result in fire or electric shock.
- Use the unit only with the voltage specified on the unit. Using a voltage higher than that which is specified may result in fire or electric shock.
- Do not cut, kink, otherwise damage nor modify the power supply cord. In addition, avoid using the power cord in close proximity to heaters, and never place heavy objects -- including the unit itself -- on the power cord, as doing so may result in fire or electric shock.
- Avoid installing or mounting the unit in unstable locations, such as on a rickety table or a slanted surface. Doing so may result in the unit falling down and causing personal injury and/or property damage.
- The apparatus shall be connected to a mains socket outlet with a protective earthing connection.
- The socket-outlet shall be installed near the equipment and the plug (disconnecting device) shall be easily accessible.

#### When the Unit is in Use

- Should the following irregularity be found during use, immediately switch off the power, disconnect the power supply plug from the AC outlet and contact your nearest TOA dealer. Make no further attempt to operate the unit in this condition as this may cause fire or electric shock.
  - If you detect smoke or a strange smell coming from the unit
  - If water or any metallic object gets into the unit
  - If the unit falls, or the unit case breaks
  - If the power supply cord is damaged (exposure of the core, disconnection, etc.)
  - If it is malfunctioning (no tone sounds.)
- To prevent a fire or electric shock, never open nor remove the unit case as there are high voltage components inside the unit. Refer all servicing to your nearest TOA dealer.
- Do not place cups, bowls, or other containers of liquid or metallic objects on top of the unit. If they accidentally spill into the unit, this may cause a fire or electric shock.
- Do not insert nor drop metallic objects or flammable materials in the ventilation slots of the unit's cover, as this may result in fire or electric shock.



## CAUTION

Indicates a potentially hazardous situation which, if mishandled, could result in moderate or minor personal injury, and/or property damage.

### When Installing the Unit

- Never plug in nor remove the power supply plug with wet hands, as doing so may cause electric shock.
- When unplugging the power supply cord, be sure to grasp the power supply plug; never pull on the cord itself. Operating the unit with a damaged power supply cord may cause a fire or electric shock.
- When moving the unit, be sure to remove its power supply cord from the wall outlet. Moving the unit with the power cord connected to the outlet may cause damage to the power cord, resulting in fire or electric shock. When removing the power cord, be sure to hold its plug to pull.
- Avoid installing the unit in humid or dusty locations, in locations exposed to the direct sunlight, near the heaters, or in locations generating sooty smoke or steam as doing otherwise may result in fire or electric shock.
- To avoid electric shocks, be sure to unplug the unit's power supply cord when connecting speakers.
- Be sure to follow the instructions below when rack-mounting the unit. Failure to do so may cause a fire or personal injury.
  - Install the equipment rack on a stable, hard floor. Fix it with anchor bolts or take other arrangements to prevent it from falling down.
  - When connecting the unit's power cord to an AC outlet, use the AC outlet with current capacity allowable to the unit.
  - No rack-mounting screws are supplied with the unit. Separately prepare the appropriate screws for the rack.
- Keep the amplifier over 10 cm (3.94") away from objects that may obstruct air flow to prevent the unit's internal temperature rise.

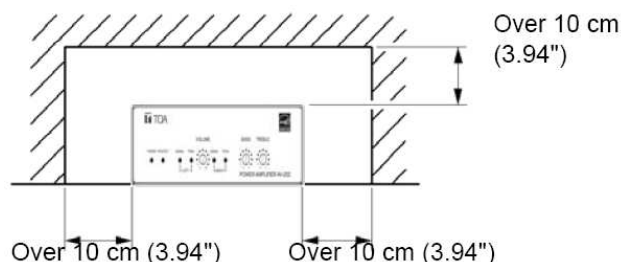

### When the Unit is in Use

- Do not place heavy objects on the unit as this may cause it to fall or break which may result in personal injury and/or property damage. In addition, the object itself may fall off and cause injury and/or damage.
- Make sure that the volume control is set to minimum position before power is switched on. Loud noise produced at high volume when power is switched on can impair hearing.
- Do not operate the unit for an extended period of time with the sound distorting. This is an indication of a malfunction, which in turn can cause heat to generate and result in a fire.
- If dust accumulates on the power supply plug or in the wall AC outlet, a fire may result. Clean it periodically. In addition, insert the plug in the wall outlet securely. internal temperature rise.
- Switch off the power, and unplug the power supply plug from the AC outlet for safety purposes when cleaning or leaving the unit unused for 10 days or more. Doing otherwise may cause a fire or electric shock.



The lightning flash with arrowhead symbol, within an equilateral triangle, is intended to alert the user to the presence of uninsulated "dangerous voltage" within the product's enclosure that may be of sufficient magnitude to constitute a risk of electric shock to persons.



## ATTENTION

L'appareil ne doit pas être exposé aux éclaboussures ou écoulements et tous objets remplis de liquide, tels que vases, ne doivent pas être sur l'appareil.

### 3. GENERAL DESCRIPTION

The AV-20D is a 2 channel digital amplifier for speech and general announcement. This compact amplifier is equipped switching power supply circuit inside, Energy Star 2.0 certified and PLENUM rated (UL 2043 listed) for the installation into air handling space without external AC adaptor. The rated output power is 15W at 8 Ohms x 2 channel, 20W at 4 Ohms x 2 channel or 40W at 8 Ohms in BTL connection. The unit is suited to use in board room, conference room and AV presentation room.

### 4. FEATURES

- 3 kinds of input connector (RTB, 3.5mm plug and RCA STEREO) with individual input level selector switch.
- Compliant with “Energy Star 2.0” to save the power automatically moving into minimum power consumption.
- High efficiency and low heat Class-D amplifier technology achieves fanless, no ventilation, convection cooling.
- Supplied VCA for remote volume control.
- Front operable bass and treble controls in recessed design to prevent accidental operation.
- Removable input/output terminal blocks facilitate installation and maintenance.
- Built-in ALC (Auto-Level Compressor) circuit to protect the connected speakers and internal components from the over loaded input.
- Working in AC100V-240V, 50Hz/60Hz.
- UL2043, plenum rated construction for in-the-ceiling installation using attached EMT adaptor plate

### 5. NOMENCLATURE AND FUNCTIONS

[Front]

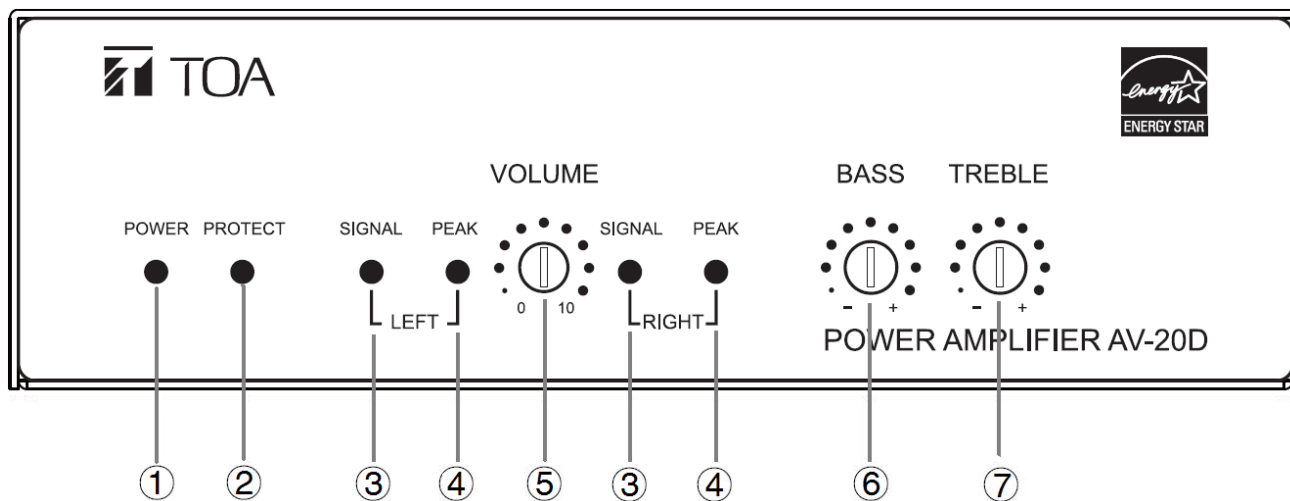

This figure represents the AV-20D

#### 1. Power on indicator

Lights green when the amplifier is powered on. If it is blinking the unit stays power saving mode.

#### 2. Protection indicator

Whenever this yellow indicator lights up, it implies that the internal protections have been triggered to protect the unit against damage. Should this protections turn on, please check if the amplifier is being overdriven or there is any short circuit in speaker wires.

#### 3. Signal level indicators (L&R channels)

Lights green when audio signals are output from the speaker output terminals.

#### 4. Peak indicators (L&R channels)

Lights red if output signals approach clipping level. If steady lit, turn down the corresponding input volume control until the indicator flashes intermittently

### 5. Master volume control

Adjusts gain of the mixed inputs. Turn the knob clockwise to increase the level and counterclockwise to decrease it.

### 6. Bass control

Turn the knob clockwise to increase bass level and counterclockwise to decrease it. The center

position of the control provides flat frequency response

### 7. Treble control

Turn the knob clockwise to increase treble level and counterclockwise to decrease it.

The center position of the control provides flat frequency response.

[Rear]

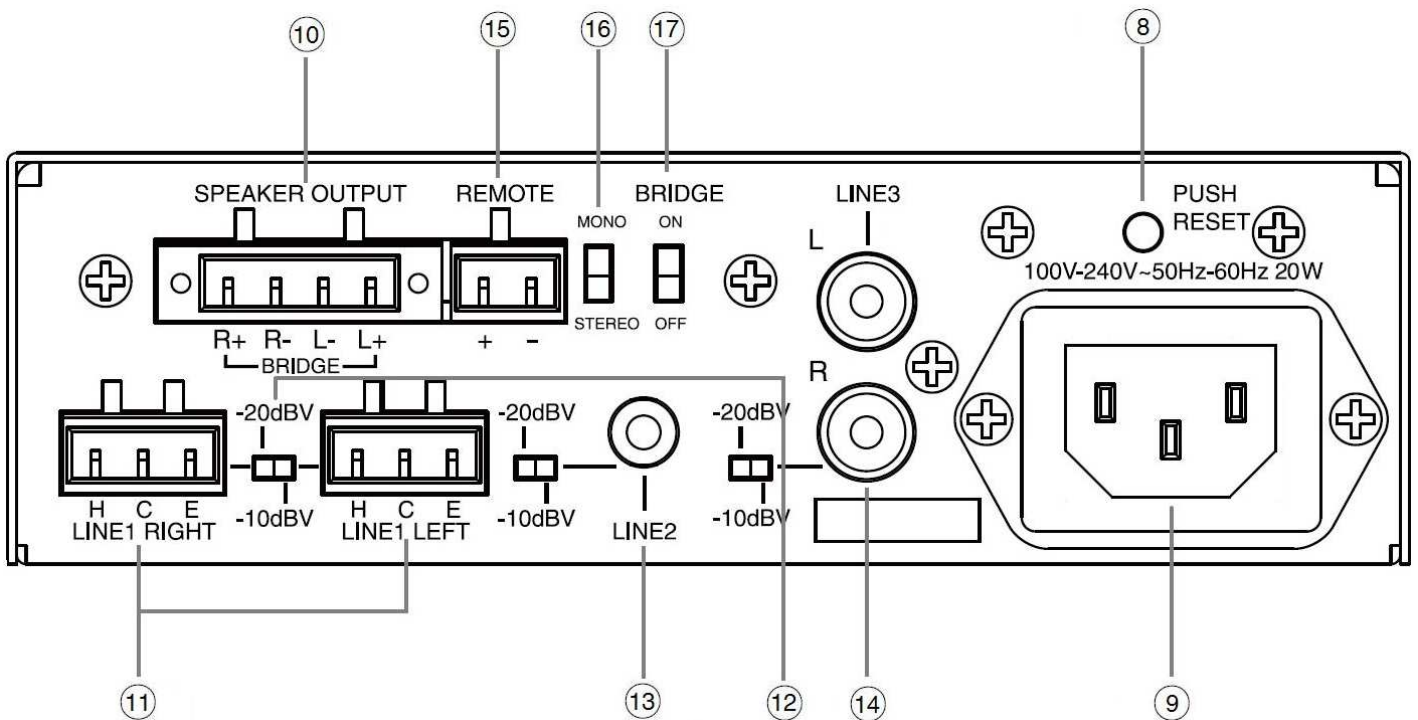

This figure represents the AV-20D

### 8. Breaker

Cuts off the AC power supply from the AC outlet if the power current exceeds the allowable value.

**Note :** The red button in the breaker pops out to indicate that the breaker has tripped. After turning off the power and eliminating the cause of the breaker trip, press the button to reset the breaker.

### 9. AC receptacle

Connect AC cord from this inlet to AC wall outlet.  
P.S.: This IEC power receptacle can be removed and replaced with Flexible Conduit Adapter using EMT adaptor plate attached to the unit. For UL2043 certification, the optional receptacle which can be directly connects AC wires with the screw terminals on the PCB is required.

### 10. Speaker output terminal

Connects to speakers. Removable terminal block, screw-lock type.

### 11. Line 1 input terminals

10K Ohms, electronically-balanced (transformer isolated), removable terminal block. Connect a microphone or sound source equipment

**12. Input level select switches**

Use these switches to adjust input gain of Line1, Line 2 and Line 3, respectively. (\*0dB=1V)

**13. Line 2 input terminal**

10K Ohms, unbalanced, 3.5mm mini Phone Jack. Connect a sound source equipment such as a CD player.

**14. Line 3 input terminals**

10K Ohms, unbalanced, RCA jack. Connect a sound source equipment such as a CD player

**15. Remote volume control**

10K Ohms, removable terminal block (2P). Use it as a remote volume control.

**16. Mono/Stereo switch**

Move the switch downwards to set the channels in stereo mode; move upwards to set the channels in mono mode.

**17. Bridge ON/OFF switch**

Move the switch downwards to set the amplifier in two channels output; move upwards to set the amplifier in bridging (BTL) mode.

## 6. CONNECTIONS

### 6.1. Removable Terminal Plug Connection

#### Notes

- Avoid soldering cable conductor, as contact resistance may increase when the cable is tightened and the solder is crushed, possibly resulting in an excessive rise in joint temperatures.
- Use cables of AWG 12 – 24.

#### [Cable end treatment]

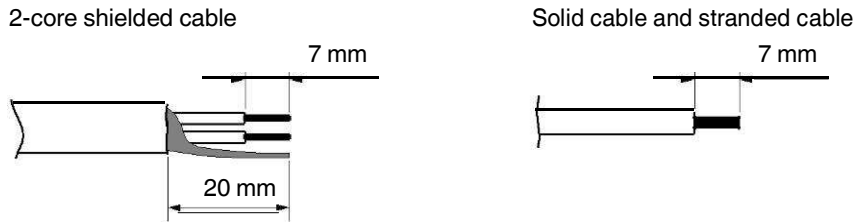

#### [Wiring Procedure]

##### Step 1. Wiring the supplied removable terminal plug.

1-1. Loosen the terminal screws to insert the wire.

1-2. Tighten the terminal screws.

Ensure that the wire does not break free when pulled. If the wire does pull free, repeat the connection procedure from the start.

**Step 2.** Insert the wired terminal plug into the corresponding terminal block in the unit's rear panel.

**Step 3.** Tighten the fixing screws. (Speaker output terminals only)

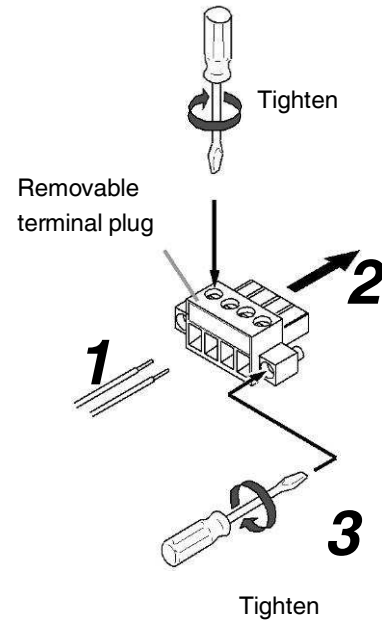

#### Notes

- Do not reverse **Steps 1** and **2**. Poor contact may result if force is applied to the unit's internal circuit board pins while the terminal screws are being tightened.
- Use an appropriate type screwdriver for terminal plug wiring.

### 6.2. Input Connections

#### 6.2.1. Line 1 input connections

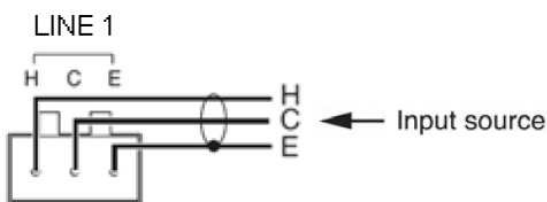

#### Note

When connecting equipment with unbalanced output, short-circuit the "C" and "E" lines as shown below.

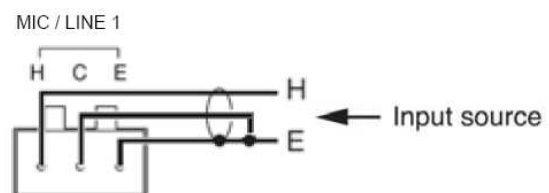



### 6.2.2. LINE 2, LINE 3 input connections

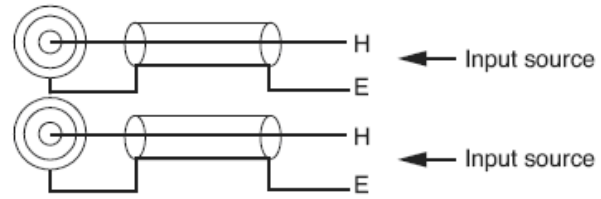
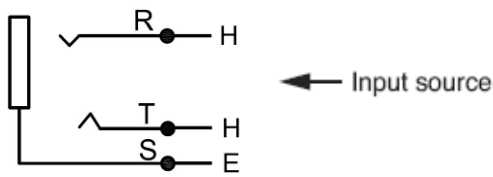

Upper and lower RCA inputs are internally, passively mixed.

### 6.3. Speaker Connections

There are two speaker output connections. Use only one for connection. Class 2 wiring may be used.

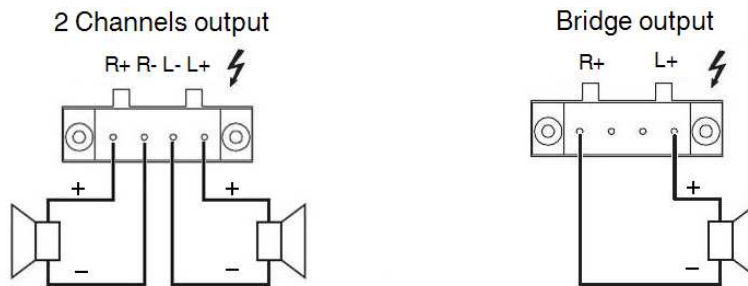

## WARNING

The terminals marked with the symbol ⚡ are hazardous live. The external wiring to these terminals requires installation by an instructed person.

### 6.4. Remote Volume Connection

When a remote volume control is needed, wiring a 10K Ohms potentiometer to the 2-pin Remote Volume Control Jack as shown below. Attenuating the value of the potentiometer will reduce the audio level. This attenuation works for the audio signal after adjusted by its master volume control.

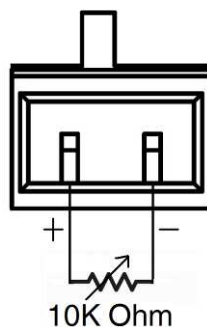

### 6.5. AC Power Connections

If necessary, this power receptacle can be replaced with flexible conduit adapter. For UL2043 certification, the optional receptacle which can be directly connected AC wires with the screw terminals on the PCB is required. For plenum space installation details, please refer to Appendix.

## 7. OPERATION

After completing all audio and control connections, connect the power supply, and check the power indicator.

### Note

When the heat sink temperature exceeds 130°C (266 °F), the protection circuit begins to operate to disconnect the output from the circuit. The disconnected output is automatically restored as soon as the temperature returns to the normal operating range.

## 8. INSTALLATION PRECAUTIONS



### CAUTION

Keep the amplifier over 10 cm (3.94") away from objects that may obstruct air flow to prevent the unit's internal temperature rise.

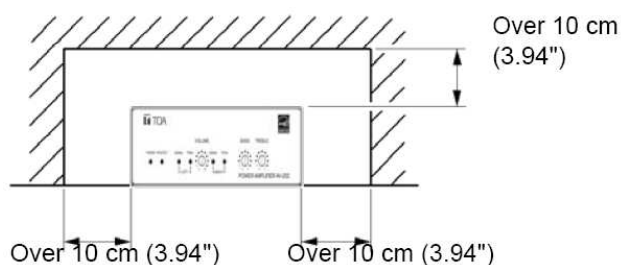

## 9. ADJUSTMENT

### 9.1. Input Sensitivity Selection

Output level are adjustable with master volume control and individual -10dBV/-20dBV switches.. For music play or announcement, adjust the proper volume control or sensitivity so that the signal indicator lights intermittently. Note that the sound quality is downgraded when the peak indicator remains lit.

For those audio source equipments which always have relative high output level, such as CD players, please set the input sensitivity selection switch to -10dBV position; otherwise, set to -20dBV position.

### 9.2. Output Volume Setting

Output level are adjustable with master volume control and individual -10dBV/-20dBV switches. For music play or announcement, adjust the proper volume control or sensitivity so that the signal indicator lights intermittently. Note that the sound quality is downgraded when the peak indicator remains lit.

When a Remove Volume Control is connected, Attenuating the value of the potentiometer will reduce the volume level. This attenuation works for the audio signal after adjusted by its master volume control.

# 10. BLOCK DIAGRAM

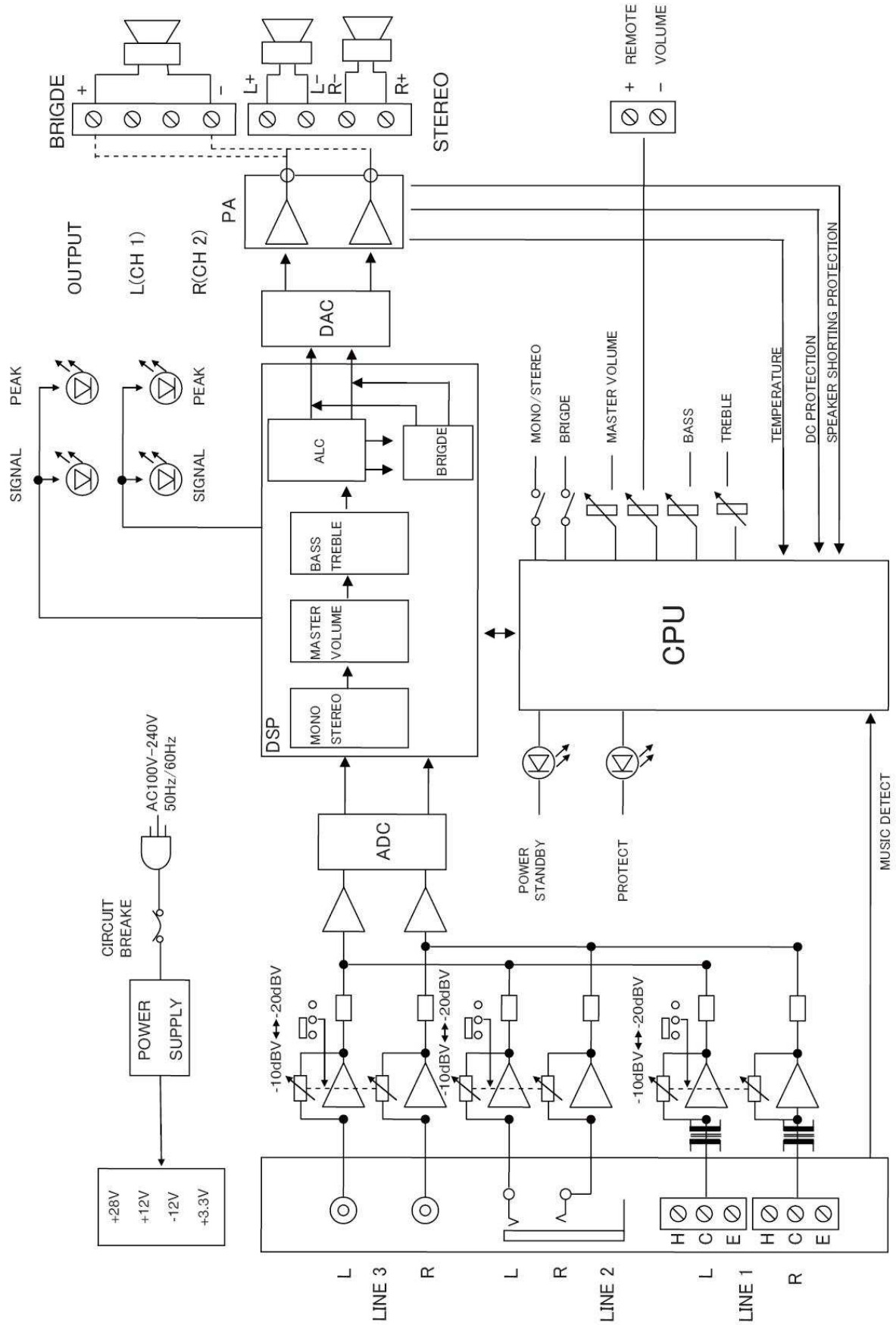

# 11. DIMENSIONAL DIAGRAM

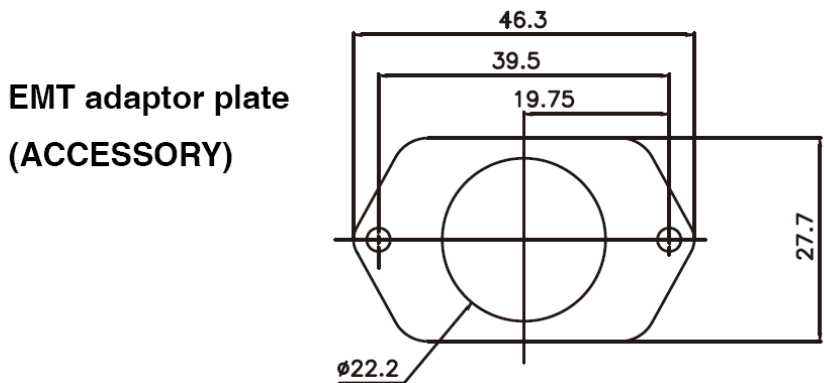
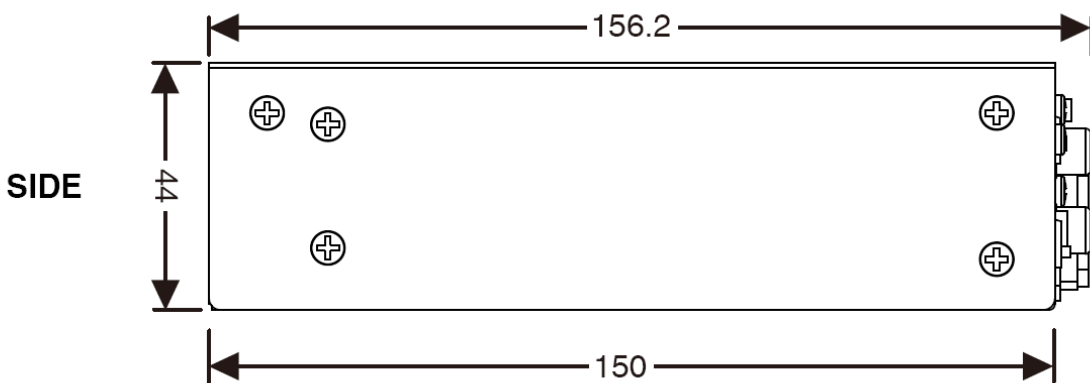
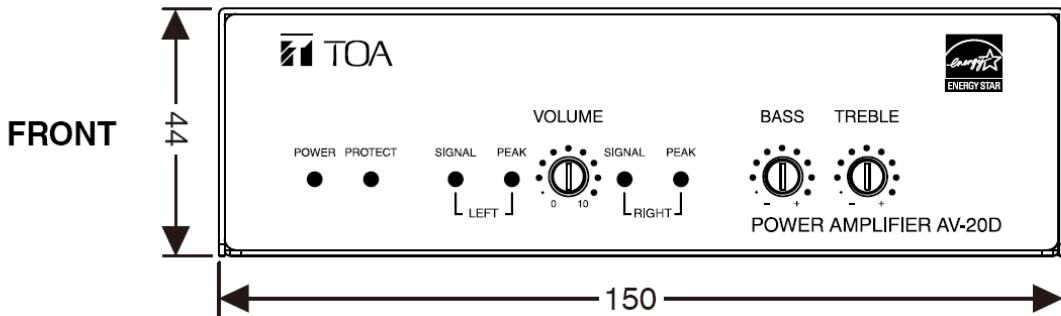
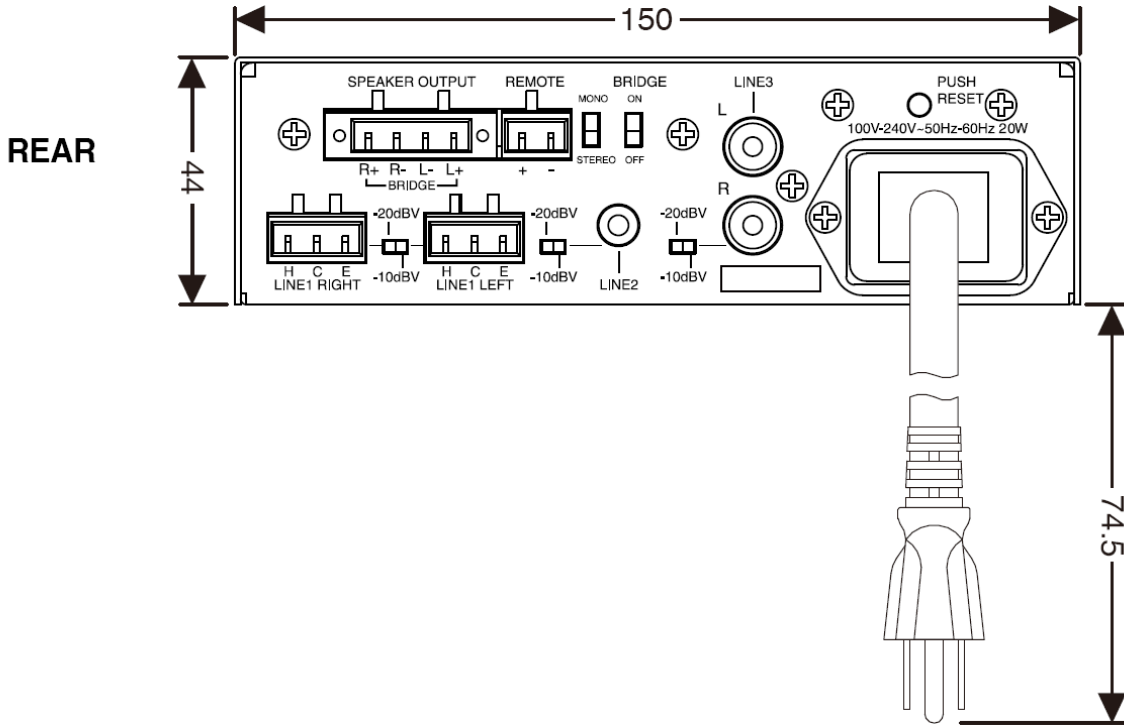

Unit:mm

## 12. SPECIFICATIONS

Model No.		AV-20D
Power Source		100V-240V AC , 50Hz/60Hz
Rated Output		15W x 2 @ 8 Ohms,20W x 2 @ 4 Ohms,40W x 1 @ 8 Ohms (Bridge)
Power Consumption	Rated Output	63W
	Idle	Less than 6W
	Power Save Mode	Less than 1W
Frequency Response		20Hz to 20KHz $\pm$ 3dB (Line1 input with transformer:100Hz to 20KHz)
Total Harmonic Distortion (THD+N)		Less than 0.15%
Input	Line 1:	-10/-20dB* (selectable), 10 K Ohms, transformer-balanced, removable terminal block
	Line 2:	-10/-20dB* (selectable), 10 K Ohms, unbalanced, 3.5mm stereo jack
	Line 3:	-10/-20dB* (selectable), 10 K Ohms, unbalanced, RCA jacks
Output		Speaker Output, Removable terminal block (4P)
Tone Control		Bass: $\pm$ 10 dB at 100 Hz, Treble: $\pm$ 10 dB at 10 kHz
Controls		Master volume control
		Remote volume control
		Bass tone control, Treble tone control
		Bridge ON/OFF Switch
		Mono/Stereo switch
		Input sensitivity switches (Line 1, Line 2, Line 3)
Indicator		Power LED, Protection LED, Signal LED, Peak LED
Other Feature		Automatic Level Control, Thermal/Over-current protection
Operating Temperature		-10 to +40°C
Case		Black metal case
Dimensions		150 (w) x 44 (h) x 156 (d) mm (5.90" x 1.73" x 6.14")
Weight		1.00 Kg (2.2 lbs)

\* 0 dB = 1 V

**Note:** The design and specifications are subject to change without notice for improvement.

### • Accessories

Removable terminal plug (2P).....	1
Removable terminal plug (3P).....	2
Removable terminal plug (4P).....	1
AC power cord .....	1
Rubber foot .....	4
EMT adaptor plate .....	1

## 13. APPENDIX – Installation Guide for Flexible Conduit Adapter Kit

### 13.1. Cautions and Warnings .

#### CAUTIONS

- \* Make sure that the AV-20D or the source devices, and all output devices are turned off and disconnected from the power source before you begin.
- \* A UL listed electrical distribution box is recommended for the termination of the conduit.
- \* The UL approved electrical distribution box and flexible conduit are not included; the installer is responsible for obtaining and installing them.

#### WARNINGS

- \* The circuit breaker used for this connection should be rated a minimum of 20 Amps.
- \* Installation and service must be performed by a qualified electrician only.
- \* This unit must be installed in accordance with the National Electrical Code and with all local codes.
- \* An all poles mains switch with a contact separation of at least 3mm in each pole must be incorporated in the electrical installation of the building. The installation must be carried out in accordance with all applicable installation rules.
- \* This unit is not to be used beyond its rated voltage range.
- \* This unit must be wired to a UL listed distribution box.
- \* If it is used for a branch-circuit wiring or anticipated at a TERMINAL connection, a minimum 14AWG (2.1mm<sup>2</sup>) conductor (2.1mm) should be used. The conductor material should be copper or aluminum.
- \* A pigtail lead should not be more than two wire sizes smaller than the mains supply conductor to which it will be connected.

### 13.2. Installation With Flexible Conduit Cable

Install the flexible conduit cable assembly to AV-20D as following procedures:

1. Remove the IEC power cord.
2. Remove and retain the two Philips head screws that secure the AC receptacle to the back panel (Fig.1).
3. Remove and retain the 10 screws that secured the top cover of AV-20D to its main chassis (Fig.2).
4. Carefully lift the top cover up, remove and retain it.
5. Use a standard screwdriver to loosen the screws holding the Hot and Neutral wires on the terminal block (Fig.3).
6. Unscrew the AC receptacle ground wire from the ground screw nut on the metal bottom of AV-20D.
7. From the back panel end, pull the AC receptacle out of the enclosure.
8. Thread the 12- or 14-gauge power wires through the length of the electrical conduit tube.
9. Install the EMT adapter plate with the conduit attached (Fig.4) into the opening from which you removed the AC receptacle. Use the Philips head screws that you removed in step 2 to attach the EMT adapter plate.
10. Slide the conduit nut (Fig.4) over the bundle of the wires exiting the conduit and onto the conduit itself. Hand tighten the nut.
11. Attach and screw down the Hot and Neutral wires exiting from the conduit to their corresponding screws on the terminal block. Be sure that the polarity of the AC wires is correct.
12. Secure firmly the ground wire from the conduit to the metal bottom by reattaching the ground wire nut.
13. Screw the cable tie mount on the corner of the PCB.
14. Thread a tie wrap through the cable tie mount, place all wires within its cradle, and zip the wrap over the bundle of wires.
15. Ensure that the conduit nut from step 10 (Fig.4) firmly secures the conduit EMT adapter plate.
16. Use the 10 screws you removed in step 3 to secure the top cover of the AV-20D back onto its main chassis.

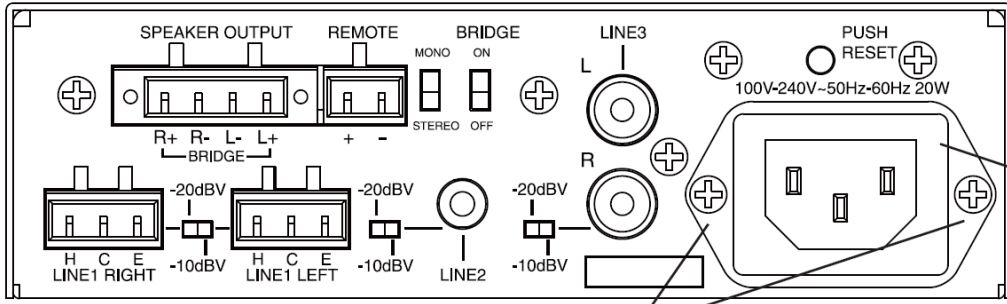

Remove two screws

Fig.1

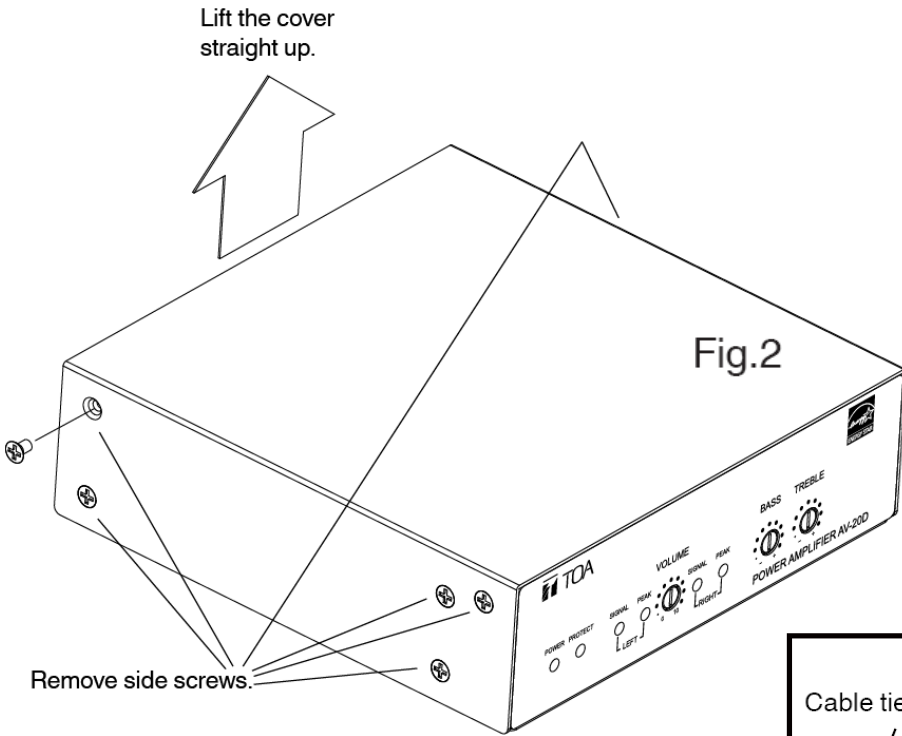

Remove side screws.

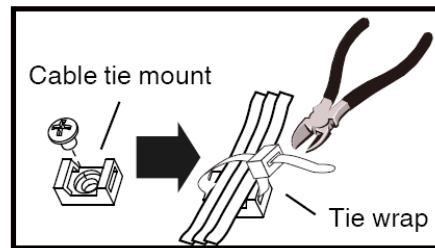

Cable tie mount

Tie wrap

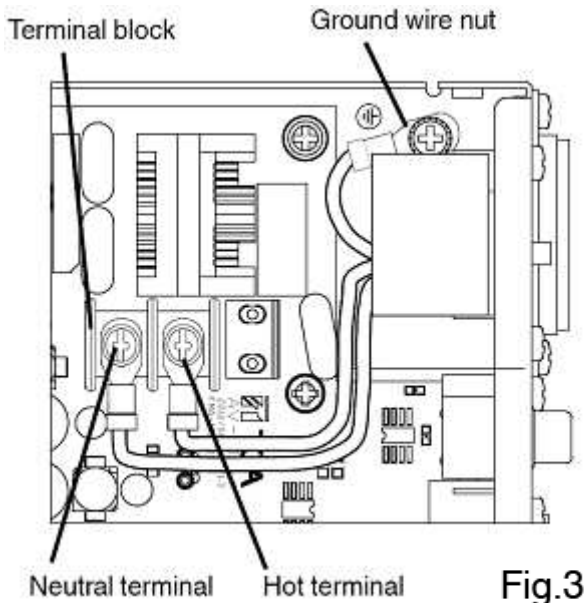

Fig.3

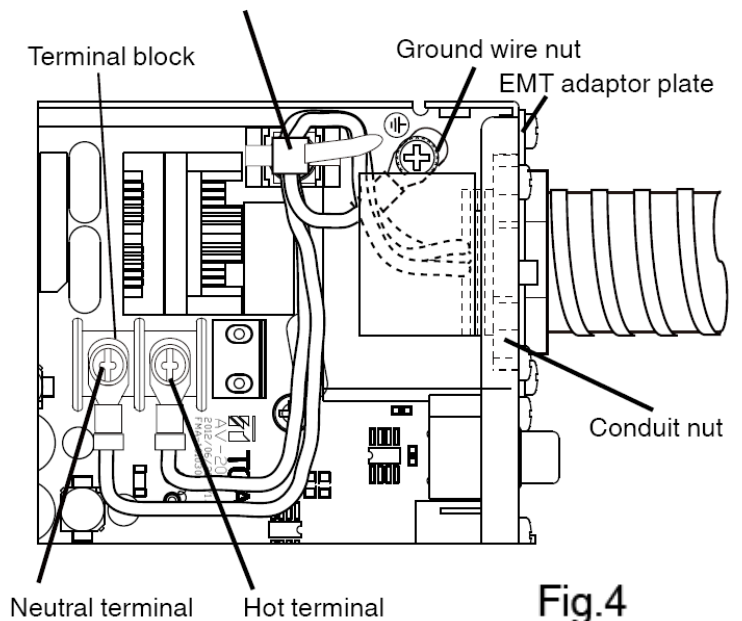

Fig.4

