



The Difference is Hear



AV Series / AV-25-2

AV-25

Owner's Manual
February 2010

www.stewartaudio.com

Important Safety Instructions

Before using your Stewart Audio Inc. Power Amplifier, please read this **Owner's Manual** carefully to ensure optimum trouble-free performance.

WARNING: TO REDUCE THE RISK OF ELECTRICAL SHOCK, DO NOT EXPOSE THIS AMPLIFIER TO RAIN OR MOISTURE. DANGEROUS HIGH VOLTAGES ARE PRESENT INSIDE THE ENCLOSURE. DO NOT OPEN THE CABINET. REFER SERVICING TO QUALIFIED PERSONNEL ONLY.

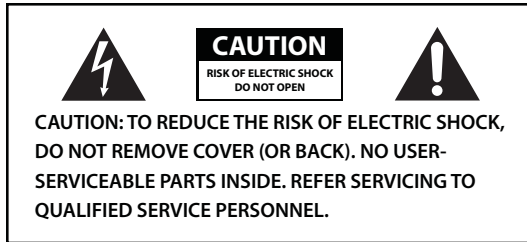

The lightning bolt within arrowhead symbol, within an equilateral triangle, is intended to alert the user to the presence of un-insulated "dangerous voltage" within the product's enclosure that may be of sufficient magnitude to constitute a risk of electrical shock to person.



The exclamation point within an equilateral triangle, is intended to alert the user to the presence of important operating and maintenance (servicing) instruction in the literature accompanying the appliance.

Important Safety Instruction – Please Read Prior to Product Installation.

1. Installation should be performed by a trained and licensed professional to insure safe and lasting operation.
2. All of the safety and operating instructions should be read before the amplifier is installed or operated. Retain these instructions for future reference. All instructions should be followed; all warnings on the amplifier and in the operating instructions should be adhered to.

3. The amplifier should be situated so that its location and position does not interfere with its proper ventilation. For example, the amplifier must not be placed on a rug, bed, sofa or similar surface that impedes airflow across the chassis. Airflow through the ventilation openings should be unobstructed.
4. This amplifier should not be used near water, for example, near a bathtub, in a wet basement, near a swimming pool, etc. This amplifier is intended to be operated in a controlled indoor environment.
5. Do not place the amplifier near heat sources such as radiators, heat registers, stoves, or other appliances that produce heat.
6. The amplifier should only be connected to 120 VAC, 60 Hz power supply. Do not defeat the ground or polarization of the power plug.
7. Route power cord and other cables so that they are not likely to be walked on, tripped over or stressed. Pay particular attention to condition of cords and cables at plugs and at the point where they exit the amplifier. To prevent risk of fire or injury, damaged cords and cables should be replaced immediately.
8. Clean the amplifier with a clean, damp cloth. Do not use solvents or abrasive cleaners. Never pour any liquid on the amplifier.
9. When left unused for a long period of time, the power cord should be unplugged from the outlet.
10. Damaged Amplifiers requiring service should be repaired by a qualified service technician when:
 - a. The power cord or AC plug has been damaged.
 - b. Objects have fallen, or liquid has spilled into the unit.
 - c. The amplifier has been exposed to rain or other moisture.
 - d. The amplifier does not appear to operate normally or exhibits a marked change in performance.
 - e. The amplifier has been dropped or the enclosure damaged.
11. The user should not attempt to service the amplifier beyond that described in the operating instructions. All other servicing should be referred to qualified service personnel.

Table of Contents

Important Safety Instructions.....	2
Table of Contents.....	4
1 Welcome	5
1.1 Features.....	5
1.2 Using this Manual.....	5
2 Setup	6
2.1 Setup Precautions.....	6
2.2 Amplifier Installation.....	6
2.2.1 Pole-Mount Installation.....	6
2.2.2 Universal-Mount Installation.....	7
2.2.3 Product Dimensions.....	8
2.3 Proper Cooling Considerations.....	8
2.4 Input Connections.....	9
2.4.1 Balanced Input Connections.....	9
2.4.2 Unbalanced Input Connections.....	10
2.5 Output Connections.....	11
3 Operation	12
3.1 Operation Precautions.....	12
3.2 Controls, Indicators, and Connectors.....	13
3.2.1 Indicators.....	14
3.2.2 Controls.....	14
3.2.3 Remote Muting.....	14
4 Troubleshooting	15
5 Technical Specifications	16
6 Warranty Information	17
6.1 Warranty Summary.....	17
6.1.1 Eligibility for Factory Repair.....	17
6.2 Return Procedure.....	17
6.2.1 Return Authorization.....	18
6.2.2 Packaging Instructions.....	18
6.2.3 Shipping Instructions.....	18
6.2.4 Estimate Approval.....	19
6.2.5 Payment of Non-Warranty Repair.....	19
7 Notes	20



This amplifier proudly designed and manufactured in the USA.

1 Welcome



Congratulations on the purchase of your new Stewart Audio AV Series power amplifier. This amplifier has been designed and built to provide you with years of high-quality audio performance and trouble-free operation. If after reading this manual you should have any questions concerning amplifier installation and operation, please contact your Authorized Stewart Dealer, or you may contact us directly using the contact information provided on the back of this manual.

1.1 Features

Your Stewart Audio AV Series amplifier is the result of years of experience in the design and manufacture of quality amplifiers. As such it provides a combination of performance and operational benefits that simply cannot be found in conventional amplifiers.

- Sub Compact 1/4 rack package
- Two channel amplifier, optimized to drive 4 Ohm and 8 Ohm loads
- Music and fire alarm muting
- Clean full-range dynamic power
- Signal Detect trigger for sleep & wake up
- Multiple mounting options
- External inline power supply
- Made in the USA

1.2 Using this Manual

In order to obtain maximum performance from your AV Series Amplifier, please take time to read this brief owner's manual and carefully follow the guidelines for connection and operation.

This manual provides you with the information necessary to safely install and operate your new AV Series amplifier in the most common scenarios. If you find yourself requiring additional assistance, please feel free to contact your Authorized Dealer, or you may contact us directly using the contact information provided on the back of this manual.

2 Setup

2.1 Setup Precautions



CAUTION: Before installing your amplifier, make sure that you have read the Important Safety Precautions at the beginning of this manual.

2.2 Amplifier Installation

The AV 25 incorporates a number of different mounting options in order to fit your installation needs.

2.2.1 Pole-Mounting

The AV Series of amplifiers is Stewart Audio's first line of pole-mountable amplifiers. The AV-25 has mount holes on both the top as well as the side of the unit which can be used with the AV-Pole bracket available from Stewart Audio.

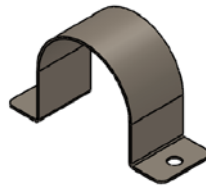

Part Number: AV-Pole

2.2.1 Universal-Mount Installation

The AV 25 also has a universal bracket available which allows the unit to be mounted against a wall or under a table. Two screws are included in the kit which will affix the bracket to the top or the side of the unit. Once this is done, two holes are available for mounting the unit where desired.

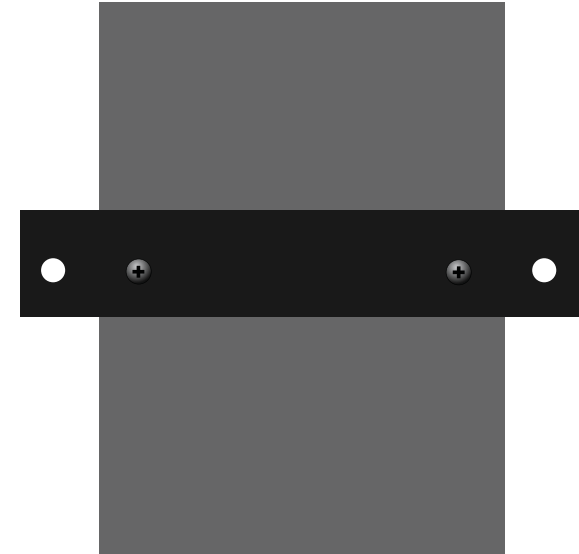

Part Number: AV-Bracket



CAUTION: Use only the screws provided in mounting brackets to the amplifier. Do not overtighten.

2.2.3 Product Dimensions

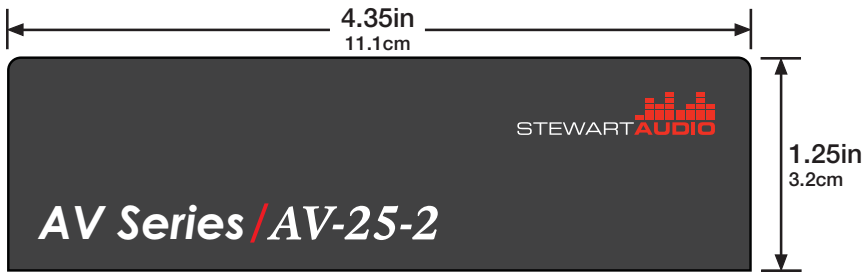

Front

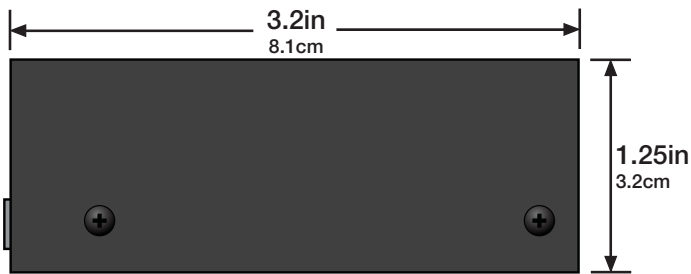

Side

2.3 Proper Cooling Considerations

Because the AV 25 regulates its temperature using convection cooling and no fans, the amplifier must be given adequate space to allow for proper airflow. Do not stack the amplifiers on top of each other or mount it in a way that other equipment will block airflow through the case.

CAUTION: Inadequate airflow to the amplifier can cause the amplifier to overheat and potentially become damaged in the process. Be sure to provide plenty of air space to allow for convection cooling.

2.4 Input Connections

Your AV25-2 amplifier is provided with a 3-pin Phoenix connector for each input. This connector will accept both balanced or unbalanced connections, however some modifications must be made for an unbalanced connection. See the next two sections for instructions on connecting your amplifier to its input source.

2.4.1 Balanced Connections

When using a balanced input source and connector, you must ensure that the hot, cold, and ground pins of the connector are matched up to the +, -, and ground pins of the AV25-2's Phoenix connector respectively. Diagrams have been provided for standard XLR and TRS connectors. Please refer to the manual of your input source in case it does not follow the standard pin-out.

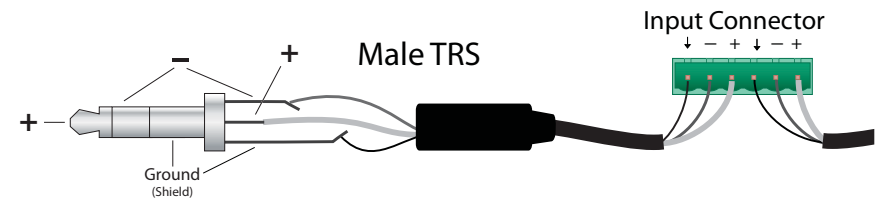
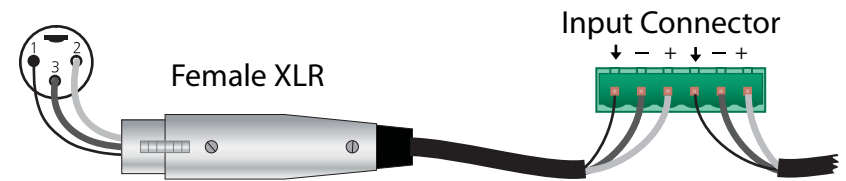

(Connector enlarged to show detail)

2.4.2 Unbalanced Connections

When using an unbalanced input source and connector, a jumper must be added between the negative (-) terminals and the ground terminals. Once this has been done, the unbalanced source can be connected to the positive (+) and ground terminals. Diagrams have been provided for standard RCA and TS connectors. Please refer to the manual of your input source in case it does not follow the standard pin-out.

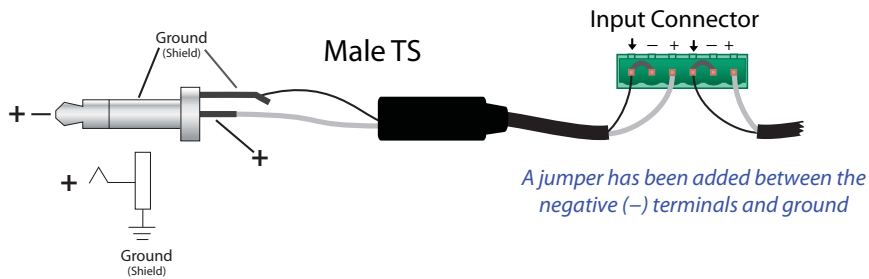
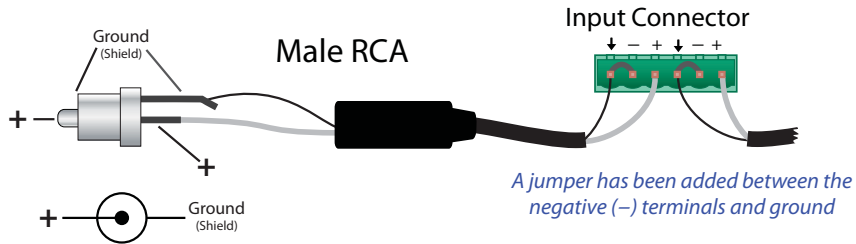

2.5 Output Connections

Stewart Audio recommends using high-quality, heavy-gauge speaker wire and connectors to send the output signal of your amplifier to the speakers. Use the following table as a guideline when selecting your wire gauge.

Distance	Wire Gauge
Up to 25 ft.	16 AWG
26-40 ft.	14 AWG
41-60 ft.	12 AWG

Speaker leads connect by means of terminal block connectors supplied with the unit. Strip speaker leads 1/4" and insert into connector observing proper polarity. With a small, flat-blade screwdriver, tighten the screw until the leads are held securely in place. Inspect for possible shorts or broken wires.

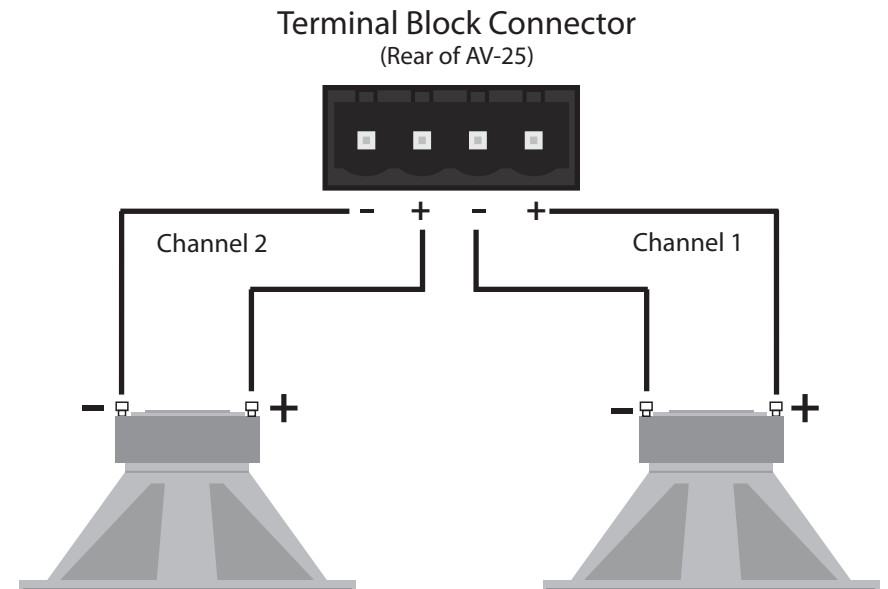

3 Operation

3.1 Operating Precautions

1. Before use, your amplifier must be configured for proper operation, including input and output wiring hookup. Improper wiring can result in damage to equipment or potentially harm to the operator. Consult section 2 for setup instructions.
2. Tampering with the circuitry, or making unauthorized changes is not only dangerous but may also violate local regulations.
3. Use care when making connections between the amplifier and the input or output equipment. Using equipment that is not capable of handling the output wattage may lead to permanent damage.



NOTE: Stewart Audio will not be held responsible for damage to your AV 25 or connected equipment if the instructions in this manual are not followed.

3.2 Controls, Indicators, and Connectors

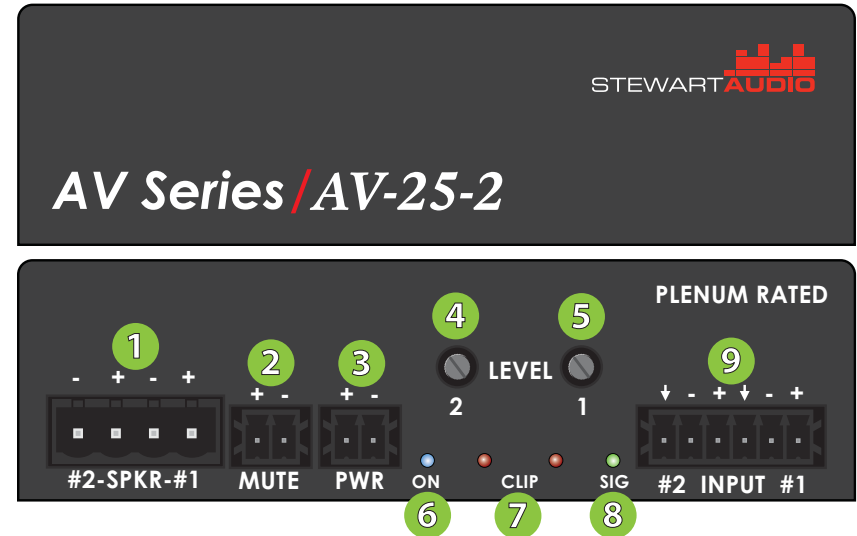

- | | |
|----------------------------|--------------------------------|
| 1 Speaker Output Connector | 6 Power Indicator LED |
| 2 Remote Mute | 7 Clip Indicator LED |
| 3 Power Connector | 8 Signal Present Indicator LED |
| 4 Channel 2 Level Knob | 9 Input Connector |
| 5 Channel 1 Level Knob | |

3.2.1 Indicators

The AV 25 has 4 rear panel LED indicators. The first is the power indicator which will illuminate when power is supplied to the amplifier. The next 2 LED indicators are the “Clip” indicators, one for each channel. These lights will indicate that the input signal is too “hot” and will sound distorted when amplified. To fix this, the gain should be reduced at the preamp or mixer level. The final light is the signal present LED which will illuminate when signal is detected on either one of the input connection channels.

3.2.2 Controls

All AV 25 controls are located on the rear of the unit. There is no power switch so the AV 25 will turn on whenever power is supplied to it. The AV25’s Signal Sense Technology (SST) will power up the amplifier from sleep when a signal is detected. After 5 minutes without an input signal the amplifier will go into sleep mode.

The rear panel contains two channel volume . The amplifier is set to run off of a line-level source and the level should be adjusted for optimum performance. To adjust this knob, you will need a small flat-head screwdriver. While a typical program source level is present, spin the rotary knob as far clockwise as you can without hearing distortion or without the “Clip” indicator illuminating. If the signal is distorting and the knob is all the way counter-clockwise, adjust the gain down at the source level.

3.2.3 Remote Mute

The AV 25 can be remotely muted when needed for such applications as muting during a fire alarm. To do so, 5-12VDC should be applied to the terminal block labeled “MUTE” on the rear of the AV 25. Polarity should be observed when connecting the triggering power source as the amplifier will not be muted if polarity is reversed.

4 Troubleshooting

Problem: Power indicator does not turn on.

Procedure: Check that the amplifier is plugged into a live outlet. After you have ensured that it is not a power issue, disconnect any speakers. If the amplifier turns on after a few seconds delay, then the problem is in the output connection. Check wiring and speakers for short circuits.

Problem: No output on one or both channels; Power indicator is lit.

Procedure: Check that level controls are not turned down. Check that input and output connections are secure. Ensure signal present LED is flashing to denote a signal. If there is no signal detected check signal source and that level controls are set high enough.

Problem: Amplifier overheats and/or shuts off.

Procedure: Review **section 2.3** on proper cooling procedures. Check the signal lights on the rear of the amplifier to see if the signal is overdriving (the signal light flashes red frequently). Overdriving the amplifier for extended periods of time can cause a thermal shutdown.

Problem: Output sound is distorted or cracking.

Procedure: Check all cables for damage or loose connections and reduce the gain on the input signal at the mixer or preamp level. Replace the cables and loudspeakers temporarily to see if this resolves the problem. If problem still exists, contact your Authorized Dealer for service.

5 Technical Specifications

Maximum Output 30Hz - 20kHz	
Stereo	25W @ 8Ω per channel
	35W @ 4Ω per channel
Frequency Response (+0, -3 dB)	30Hz-20kHz
Bandwidth +/- 3.0dB	30Hz-30kHz
THD+N	<0.1%
Signal to noise ratio	>100dB
External Mute	5-12VDC
Slew Rate	30V/ms
Input Sensitivity	0.5V (-3 dBV)
Standard Voltage Gain	28X (26.5dB)
Input Impedance (Balance/Unbalanced)	20k Ohms/10k Ohms
Sleep, Idle Current Draw, 1/8 Draw	0.005/0.01/0.15 Amps
Class	D
Input Connectors	Euro Block
Output Connectors	Euro Block
Power Supply	External In-Line 48DVC
Cooling	Convection-Cooling
Controls	Level
LED Indicators	Power, Signal Present & Clip
Construction	Aluminum Chassis
Dimensions	
Height	1.25in (3.2cm)
Width	4.35in (11.1cm)
Depth	3.2in (8.1cm)
Weight	0.37bs (0.16kg)

Stewart Audio reserves the right to change features and specifications without notice.

6 Warranty Information

6.1 Warranty Summary

All Stewart Audio amplifiers and accessories, unless excluded in this summary, are covered by a 3-year limited warranty on parts and labor from the date of purchase. In order to be eligible for warranty repairs, the amplifiers and accessories must have been purchased through an authorized Stewart Audio dealer and submitted by the original purchaser. This warranty is only valid in the country in which the amplifier was purchased.

6.1.1 Eligibility Requirements.

Stewart Audio warrants against all malfunctions which come as a result of component or manufacturer defect. The amplifier is also covered from all failures which arise during the warranty period (3 years from date of purchase) that are not a result of misuse. The following actions will void your warranty:

- The power cord or AC plug has been damaged through misuse.
- The amplifier has been exposed to moisture or extreme temperatures.
- The amplifier has been dropped, items have been dropped on the amplifier, or the enclosure has been damaged.
- The amplifier has been opened by the operator.
- The amplifier was improperly packaged when sending to the factory for repair, resulting in damage.
- Any of the precautions or instructions found in this manual were not followed.

Damages resulting to the amplifier which are not covered under this warranty can be factory-repaired at cost to the customer. Use the contact information below to initiate the repair process.

6.2 Return Procedure

This section includes the return procedures which must be followed in order to prevent processing delay or cost to the customer. Please read the entire section before contacting Stewart Audio for returns.

6.2.1 Return Authorization Number

All returns to the factory for service must be accompanied by a Return Authorization (RA) number. One can be obtained by contacting Stewart Audio at (209) 588-8111 or via e-mail at support@stewartaudio.com.

NOTE: Any defective products received without an RA number will be returned to sender at their expense.

If Stewart Audio is unable to contact the sender in 14 days, the merchandise will be considered scrap and may be disposed of.

6.2.2 Shipment Instructions

If Stewart Audio requests that you ship the defective product back to their service center, please refer to the guide below. To ensure prompt warranty service, be sure to follow all instructions.

1. Return Authorization (RA) is required for product being sent to the factory for service.
2. See packing instructions in **section 6.2.3**.
3. Ship the defective product using a method which provides for order tracking or order confirmation. The service center is located at the following address:

Stewart Audio
14397 Cuesta Court Suite D1
Sonora, CA 95370

4. Use a bold black marker and write the RA number on three sides of the box.
5. Record the RMA number for future reference. The RA number can be used to check the repair status.

6.2.3 Packaging Instructions

Should Stewart Audio request that you ship your product to their service center, these instructions must be followed in order to ensure safe delivery. If they are not followed, Stewart Audio assumes no responsibility for damaged goods and/or accessories that are sent with your unit.

6.2.3 Packaging Instructions (cont.)

1. Please write the RA number on three sides of the box. Include the Stewart Audio RA number inside the box and a brief description of the problem.
2. Do not ship any accessories (manuals, cords, hardware, etc.) with your unit. These items are not needed to service your product. Stewart Audio will not be held responsible for these items if they are returned with the amplifiers.
3. When shipping your amplifier, it is important that it has adequate protection. We recommend you use the original packing material when returning the product for repair. If you do not have the original box, see number 4.
4. If you provide your own shipping pack, the minimum recommended requirements for materials are as follows:
 - a. 275 P.S.I. burst test, Double-Wall carton that allows for 2-inch solid Styrofoam on all six sides of unit or 3 inches of plastic bubble wrap on all six sides of unit.
 - b. Securely seal the package with an adequate carton sealing tape.
 - c. Do not use light boxes or "peanuts".

NOTE: Damage caused by poor packaging will not be covered under warranty.

6.2.4 Estimate Approval

An estimate for all non-warranty repairs will be provided to the customer once the unit has been shipped to the factory. The customer is responsible to approve this estimate within 7 days. If the repairs are not approved within 14 days, Stewart Audio reserves the right to consider the unit scrap and may discard it.

6.2.5 Payment of Non-Warranty Repairs

Payment for non-warranty repairs must be submitted to Stewart Audio before the product will be returned to the customer.