

CRA-1 Specifications

Model name	CRA-1	
Operating temperature	0 to 40°C	
Reading range	8.0 x 5.0 inches (203.2 x 127.0 mm)	
Reading resolution	0.0127 mm	
Reading accuracy	0.42 mm	
Reading speed	120 rps	
Pen pressure level	1,024 levels	
Wireless band used	2.4 GHz	
Communication range	Approx. 49.2 feet (15 m) (differs depending on usage conditions)	
Power supply	Lithium-ion battery	
Continuous operation time	Approx. 16 hours (differs depending on usage conditions)	
Auto power off time	Approx. 30 minutes	
Full charging time	Approx. 4 hours	
Consumption current	When using USB	5 V 500 mA
	When using lithium-ion battery	3.7 V 60 mA
Computer model	IBM compatible computer equipped with a standard USB port and CD-ROM drive (Operation is not guaranteed for all computer environments.)	
Compatible OS	Windows® 7 (32-bit) / Vista SP1 (32-bit) / XP SP2 (32-bit)	
External dimensions (W x D x H)	12 13/32" x 10 1/8" x 29/32" (315 x 257 x 23 mm)	
Weight	23.6 oz (670 g) (including Tablet, Pen, Wireless adapter, Dry cell AAA battery, and Lithium-ion battery for tablet)	

Design and specifications are subject to change without prior notice.
The images in this brochure are simulated.

-ELMO- is a trademark of ELMO COMPANY, LIMITED.

Other brand names and product names may be trademarks or registered trademarks of their respective owners.

CRA-1 Compatible Document Camera Lineup



Note: The TT-02s and P10S are also compatible with the CRA-1.

ELMO's Helping to Provide a Greener Future for Our Children

This ELMO product complies with RoHS Directive 2002/95/EC (Restriction Of the use of certain Hazardous Substances in electronic equipment). This compliance helps to ensure a healthier and greener environment for all our children.

Profile

All dimensions in inches (mm)

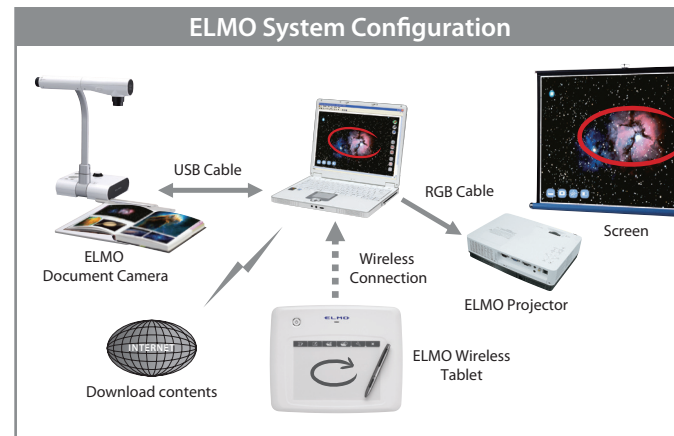
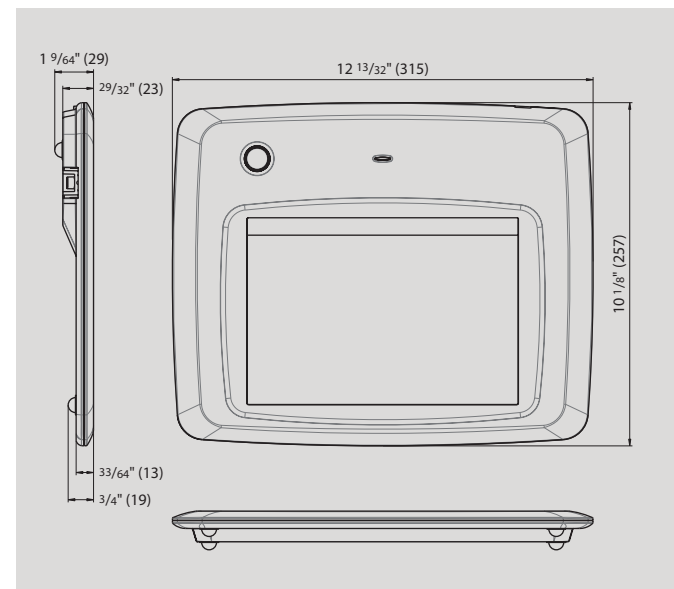

LET'S Start ICT in Education with "Document Camera"!

Visit the ELMO global website to understand what a document camera is in 13 different languages. The ELMO global website introduces you to the useful and effective ways of using the document camera and how the ELMO document camera is used and supported by teachers worldwide. <http://www.elmoglobal.com>



ELMO CO., LTD. is one of the sponsors for Japan Committee Vaccines for the World's Children (JCV).

JCV operates under basic guidelines and objectives of the Children's Vaccine Initiative (CVI) founded in 1990 by UNICEF, WHO, UNDP, the Rockefeller Foundation, and the World Bank.

ISO 9001
ISO 14001

ELMO CO., LTD. (Head Office and Factory's QMS/EMS has been registered to ISO 9001 & 14001 : 2004.



ELMO CO., LTD.

6-14, Meizen-cho, Mizuho-ku
Nagoya, 467-8567, Japan
E-mail : overseassales@elmo.co.jp

Distributed by

Additional technical information is available from any of the following subsidiary companies:

ELMO USA Corp.

Headquarters
1478 Old Country Road
Plainview, NY 11803-5034, U.S.A.
Tel. (516) 501-1400
Fax. (516) 501-0429
E-mail : elmo@elmousa.com
Web : <http://www.elmousa.com>

West Coast Branch

5676 Corporate Avenue
Cypress, CA 90630, U.S.A.
Tel. (714) 828-8457
Fax. (714) 828-8429

ELMO Europe SAS

7C Place du Dôme
Immeuble Elysées la Défense
92056 Paris la Défense, France
Tel. +33 (0)1 73 02 67 06
Fax. +33 (0)1 72 75 67 10



This brochure is printed on recycled paper with soy ink.

Printed in Japan (O) 09/2010

ELMO

Thorax

Forewing

Hindwing

An Interactive Link to
Better Teaching, Better Learning



ELMO Wireless Slate / Tablet CRA-1

Teacher's Choice

What Makes the ELMO Wireless Tablet Special

Adds Style and Impact to Presentations

Thanks to the ELMO Wireless Tablet with Image Mate Accent Software, teachers can now annotate live images from an ELMO document camera to deliver more detailed instruction and achieve greater student engagement. The ELMO Tablet partners effortlessly with an ELMO document camera for dynamic, smooth-flowing lessons. In addition, applying mask, highlight, and split screen functions to captured images focuses student attention and brings interactive learning into the picture.

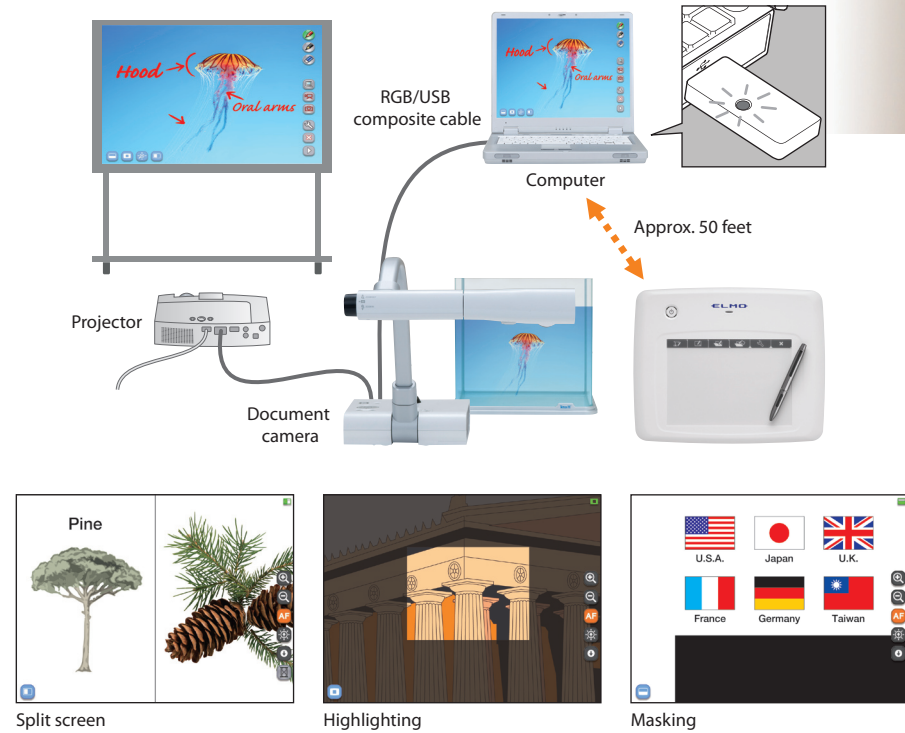

Can Be Used from Anywhere in the Room

Because the ELMO Tablet is wireless and can remotely control an ELMO document camera, teachers can move freely around the classroom (within 50 feet of the computer), making it possible to interact with the entire class and individual students.



Teacher Presentations

With ELMO as a partner, teachers can make both moving and still images a visually enticing part of their lessons. Using an ELMO document camera with an ELMO Tablet sets the stage for creative teaching and focused learning by enabling the simultaneous display of visuals that stimulate student curiosity and teacher annotations that make difficult concepts easier to grasp.



Teacher-Student Presentations

When teachers, students, and ELMO team up for a presentation, interactive learning takes off and creativity soars. The ELMO document camera can capture every step of a student science experiment in vivid detail while the entire class looks on, and the teacher guides them through it with annotations and key words written on an ELMO Tablet.



Student Presentations

With ELMO, students can share real-life objects and real-time observations with classmates through self-styled presentations that engage everyone in the classroom. The ELMO document camera makes any student drawing, magazine photo, PowerPoint slide, fossil specimen, or lively beetle the centerpiece of interactive learning, and the ELMO Tablet lets students put their own creative mark on presentations.



Intuitive Operation

Special Pen for Easy Annotation

The ELMO Tablet pen makes writing smooth and easy. Teachers can use the pen to annotate images captured by an ELMO document camera, write on Internet content, or enhance their own digital teaching materials. For added emphasis, adjusting the amount of pressure applied to the pen when writing changes the thickness of the lines.

Simple User Interface

Six shortcut keys ensure easy navigation of the ELMO Tablet, even for first-time users.

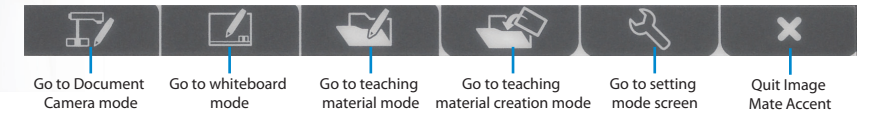

Works like a Computer Mouse

The ELMO Tablet pen can function like a mouse to operate all your computer functions.



High-Performance Functions with Image Mate Accent Software

Choice of Backgrounds

To help teachers get their points across, Whiteboard mode offers a choice of six lesson-reinforcing backgrounds—including musical score, horizontal lines, and graph paper.

Tools for Creating Original Teaching Materials

Images saved on a computer can be used to create original teaching materials. And Image Mate Accent software includes 50 stamps—with eye-catching illustrations of everything from people to weather to sports—to help teachers instantly liven up their teaching materials.

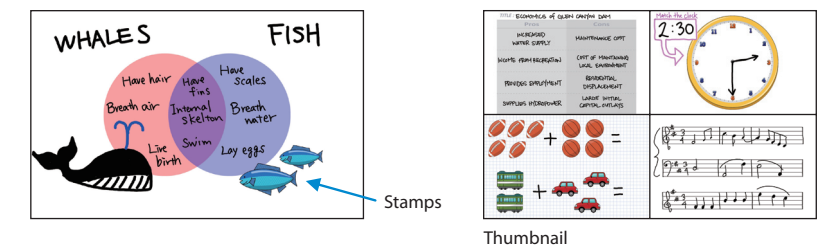

A Trio of Recording Functions

With the ELMO Tablet, video with audio, time-lapse photography, and still images saved on a computer can all be used to create high-impact teaching materials.

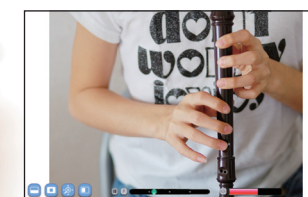

Video with audio

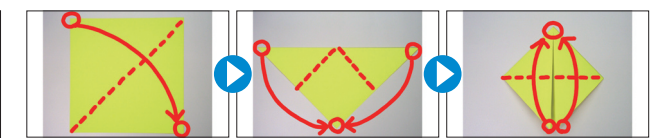

Illustrate work process



Time-lapse photography

User-Friendly Design

Easy Setup

With a simple press of the ON button, the ELMO Tablet is ready to use.

Long Battery Life

A fully charged battery can last up to 16 hours—more than enough for a full day of classes.

Easy Handling

The ELMO Tablet fits securely in hand, making it easy for teachers to hold and to use, whether they are standing still or moving around the classroom.