

Teacher's + Choice

ELMO

Instruction Manual

Student Response System

CRV-24/32

Please read this manual before using this product.
Please retain this manual.

IMPORTANT SAFETY INSTRUCTIONS

- 1) Read these instructions.
- 2) Keep these instructions.
- 3) Heed all warnings.
- 4) Follow all instructions.
- 5) Do not use this apparatus near water.
- 6) Clean only with dry cloth.
- 7) Do not block any ventilation openings, Install in accordance with the manufacturer's instructions.
- 8) Do not install near any heat sources such as radiators, heat registers, stoves, or other apparatus (including amplifiers) that produce heat.
- 9) Do not defeat the safety purpose of the polarized or grounding-type plug. A polarized plug has two blades with one wider than the other. A grounding type plug has two blades and a third grounding prong. The wide blade or the third prong are provided for your safety. If the provided plug does not fit into your outlet, consult an electrician for replacement of the obsolete outlet.
- 10) Protect the power cord from being walked on or pinched particularly at

plugs, convenience receptacles, and the point where they exit from the apparatus.

11) Only use attachments/accessories specified by the manufacturer.

12) Use only with the cart, stand, tripod, bracket, or table

specified by the manufacturer, or sold with the apparatus.

When a cart is used, use caution when moving the cart/apparatus combination to avoid injury from tip-over.

13) Unplug this apparatus during lightning storms or when unused for long periods of time.

14) Refer all servicing to qualified service personnel. Servicing is required when the apparatus has been damaged in any way, such as power-supply cord or plug is damaged, liquid has been spilled or objects have fallen into the apparatus, the apparatus has been exposed to rain or moisture, does not operate normally, or has been dropped.



The lightning flash with arrowhead symbol, within an equilateral triangle, is intended to alert the user to the presence of uninsulated "dangerous voltage" within the product's enclosure that may be of sufficient magnitude to constitute a risk of electric shock to persons. This marking is located at the bottom of product.

The exclamation point within an equilateral triangle is intended to alert the user to the presence of important operating and maintenance (servicing) instructions in the literature accompanying the product.

WARNING:

TO REDUCE THE RISK OF FIRE OR ELECTRIC SHOCK, DO NOT EXPOSE THIS PRODUCT TO RAIN OR MOISTURE.

WARNING: Handling the cord on this product or cords associated with accessories sold with this product, will expose you to lead, a chemical known to the State of California to cause birth defects or other reproductive harm. Wash hands after handling.

NOTICE:

This Class B digital apparatus complies with Canadian ICES-003.

This device complies with Part 15 of the FCC Rules and with RSS-210 of Industry Canada. Operation is subject to the following two conditions:

- (1) this device may not cause harmful interference, and
- (2) this device must accept any interference received, including interference that may cause undesired operation.

Changes or modifications made to this equipment not expressly approved by ELMO CO.,LTD. may void the FCC authorization to operate this equipment.

This equipment has been tested and found to comply with the limits for a Class B digital device, pursuant to Part 15 of the FCC Rules. These limits are designed to provide reasonable protection against harmful interference in a residential installation. This equipment generates, uses and can radiate radio frequency energy and, if not installed and used in accordance with the instructions, may cause harmful interference to radio communications. However, there is no guarantee that interference will not occur in a particular installation. If this equipment does cause harmful interference to radio or television reception, which can be determined by turning the equipment off and on, the user is encouraged to try to correct the interference by one or more of the following measures:

- Reorient or relocate the receiving antenna.
- Increase the separation between the equipment and receiver.
- Connect the equipment into an outlet on a circuit different from that to which the receiver is connected.
- Consult the dealer or an experienced radio/TV technician for help.

Cet appareil numérique de la classe B est conforme à la norme NMB-003 du Canada.

Le présent appareil est conforme aux CNR d'Industrie Canada applicables aux appareils radio exempts de licence. L'exploitation est autorisée aux deux conditions suivantes :

- (1) l'appareil ne doit pas produire de brouillage, et
- (2) l'utilisateur de l'appareil doit accepter tout brouillage radioélectrique subi, même si le brouillage est susceptible d'en compromettre le fonctionnement.

Radiofrequency radiation exposure Information:

The radiated output power of the device is far below the FCC radio frequency exposure limits. Nevertheless, the device shall be used in such a manner that the potential for human contact during normal operation is minimized.

This equipment complies with IC radiation exposure limits set forth for an uncontrolled environment and meets RSS-102 of the IC radio frequency (RF) Exposure rules. This equipment has very low levels of RF energy that are deemed to comply without testing of specific absorption ratio (SAR).

Cet équipement est conforme aux limites d'exposition aux rayonnements énoncées pour un environnement non contrôlé et respecte les règles d'exposition aux fréquences radioélectriques (RF) CNR-102 de l'IC. Cet équipement émet une énergie RF très faible qui est considérée conforme sans évaluation du débit d'absorption spécifique (DAS).



IMPORTANT SAFEGUARDS

Follow these guidelines to use the product safely.







These "IMPORTANT SAFEGUARDS" indicate important points that should be followed to use this product safely and correctly and prevent damage to the product or other property and injury to you and others.

Read carefully before operating the product and retain for future reference.

Read the manual after making sure that you understand the meaning of the following displays and symbols.

	Warning	This symbol indicates information that, if ignored, could possibly result in serious personal injury or even death due to incorrect handling.
	Attention	This symbol indicates information that, if ignored, could possibly result in personal injury or damage to property due to incorrect handling.

Symbols Used in this Manual

	Name: Caution Meaning: Indicates that the user must, without fail, pay careful attention to any sentences or illustrations marked with a Caution symbol.
	Name: Prohibited Meaning: Indicates that the user must pay careful attention to any sentences or illustrations marked with a Prohibited (do not do) symbol.
	Name: Compulsory Meaning: Indicates that the user must pay careful attention to any sentences or illustrations marked with a Compulsory (must do) symbol.
	Name: Do not use in a bathroom or shower cubicle Meaning: Indicates that using the product in a bathroom or shower cubicle could result in injuries through a fire or electric shock, and is strictly prohibited.
	Name: Do not touch Meaning: Indicates that touching the area could result in injuries through electric shock, and is strictly prohibited.
	Meaning: Do not disassemble Meaning: Indicates that disassembling the product could result in injuries through electric shock, and is strictly prohibited.

Warning

If for any reason smoke comes out of the product, or you notice any unusual odors or sounds, immediately turn off the power switch on the product and remove the batteries. Then remove the wireless adapter from your computer.



Continuing to use the product in this condition could result in a fire or electric shock. Check that smoke is no longer coming out of the product, and then contact your local dealer to request maintenance. Do not attempt to service this product yourself.

If for any reason liquid is spilled into the product, immediately turn off the power switch on the clicker and remove the batteries. Then remove the wireless adapter from your computer and contact your local dealer immediately. Continuing to use the product in this condition could result in a fire or electric shock.



If for any reason foreign objects enter the product, immediately turn off the power switch on the clicker and remove the batteries. Then remove the wireless adapter from your computer and contact your local dealer immediately. Continuing to use the product in this condition could result in a fire or electric shock. (Be extra careful if there are children in the area when using the product.)



If for any reason the product is dropped or damaged, turn off the power switch on the clicker and remove the batteries. Then remove the wireless adapter from your computer and contact your local dealer. Continuing to use the product in this condition could result in a fire or electric shock.



Do not remove the cover from the product. Doing so may expose you to dangerous voltage and could result in electric shock.



Contact your local dealer for any internal inspections, maintenance, or repair.

Do not remodel the product. This could result in a fire or electric shock.



Do not place the product on an uneven surface or unstable stand. It could fall or topple over and result in an injury.



Do not spill water on the product. This could result in a fire or electric shock.



Do not use the product in a bathroom or shower cubicle. This could result in a fire or electric shock.



Do not touch the product or the wireless adapter during a thunder storm. This could result in an electric shock.



Do not place the product or the wireless adapter where someone can trip over it. This could result in injury.



Do not drive a nail into, hammer or stamp on the product.

Otherwise the product may be damaged or deformed and shorted and result in leakage, heat, smoke, explosion or fire.



Warning

Do not apply any heavy impact to the product or throw it. Otherwise the product may be damaged or deformed and shorted and result in leakage, heat, smoke, explosion or fire.



Do not use a battery that appears to be damaged or deformed in any way. This could result in leakage, heat, smoke, explosion or fire.



Do not reverse the battery's polarity (\pm reversed). Abnormal chemical reaction may occur inside the battery which could result in leakage, heat, smoke, explosion or fire.



If any liquid from a battery leaks onto your skin or clothes, immediately flush the area with clean water, without rubbing it, then seek medical attention right away.



Otherwise the liquid may harm your skin.

Keep parts of the product out of children's reach as there is a danger they could be swallowed and cause bodily harm. If any of the parts are swallowed, consult a doctor immediately.



Attention

Do not place the product in a damp or dusty location.

This could result in a fire or electric shock.



Do not place the product in a location where it could be exposed to smoke, steam, or water droplets such as on a kitchen counter or near a humidifier. This could result in a fire or electric shock.



If this product is not going to be used for a long time, take the batteries out of the product. Otherwise it could result in fire.



Ask the dealer from where you purchased this product for regular maintenance. A buildup of dust inside the product can cause fire or malfunction.



Do not put the product on an electromagnetic cooker or in a microwave oven or a pressure cooker. The battery will be damaged and leakage, heat, smoke, explosion or fire may occur.



Do not put the clicker, strap or other accessories into your mouth. It may harm your health.



Do not swing the strap around with the clicker attached. The strap may be cut and the clicker may hit someone causing injury or may damage an object in the vicinity.



Usage precautions

■ About radio waves used by the clicker

The clicker uses radio waves on the 2.4 GHz band. When using the clicker, a radio station license is not necessary. However, please note the following precautions.

Do not use the clicker near the following:

- Microwave ovens or industrial, scientific or medical equipments, such as pacemakers
- In-factory radio stations for mobile unit identification systems (radio stations that require a license) used in production lines of factories.
- Specified low power radio stations (radio stations that do not require a license)
- IEEE802.11b/g/n wireless LAN devices

When the clicker is used near any of the equipment mentioned above, it is possible that electric wave interference could occur.

When using the clickers, keep at least 20cm distance between the clickers.

Do not cover the upper part of the clicker with your hand. The wireless connection with the wireless adapter may be degraded.

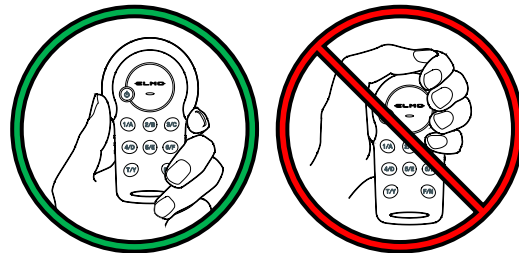

In an environment where there are many obstacles, the wireless connection with the wireless adapter may be degraded.

■ About wireless equipment used on the 2.4 GHz band

This frequency bandwidth is the same as for industrial, scientific, and medical equipment such as microwave ovens, mobile unit identification systems (radio stations that require a license) used in factory production lines, and specified low-power radio stations (radio stations that do not require a license).

- Before using this product, check that there are no radio stations for mobile unit identification systems or specified low-power radio stations nearby.
- If this product emits radio waves which interfere with in-factory radio stations for mobile unit identification systems, cease the use immediately and stop generating the radio waves. For information on countermeasures, etc. (for example, erecting partitions), contact one of our sales offices whose details are provided at the end of this manual.
- If this unit emits radio waves which interfere with specified low-power radio stations used for mobile unit identification systems, or causes similar problems, contact one of our sales offices whose details are provided at the end of this manual.

■ Usage environment / Storage

- The clicker is designed for inside use. Outside use is not recommended.
- Do not place the clicker in any humid, dusty, salt bearing wind, or vibrating locations.
- Use the clicker product under the following environmental conditions:
 - Temperature: 0°C - 40°C (32°F - 104°F)
 - Humidity: 30% - 90% (No condensation)
- When storing the product, do not leave it under direct sunlight or by heaters. It may be discolored, deformed, or damaged.

■ Maintenance

- Perform cleaning of the clicker in a dry place. Make sure to remove the batteries before cleaning.
- Use a soft, dry cloth for cleaning.
- To remove heavy dirt, moisten a soft cloth with diluted neutral detergent and wipe the dirt after wringing the cloth.
- Do not use any volatile solvent such as thinner or benzene.

CONTENTS

IMPORTANT SAFETY INSTRUCTIONS	2
IMPORTANT SAFEGUARDS	4
Usage precautions	7
Before Use	12
Main functions	13
Supplied Items.....	14
Part Names	15
Preparation	17
Insert the batteries into the clicker.....	17
Attach the clicker number sticker (if necessary)	17
Software installation	18
Connecting the wireless adapter	19
Launching Image Mate Accent for SRS.....	19
Database Selection	20
About Image Mate Accent	21
Basic Screen	21
Basic Screen Configuration.....	21
Various Operation Modes	22
Diagram of the modes	22
PC Annotation Mode	23
PC Operation Mode	23
Document Camera Mode	23
Whiteboard Mode	23
Teaching Material Import Mode	24
Drawing Operation	26
Drawing	26
Deleting	27
Recording a Lesson	28
Operating the Document Camera	30
Mask Function.....	31
Highlight Function	32
Scroll Function	33
Using PowerPoint Support Function	34
Setting the Pen.....	35
List of Menu icons	36
Using SRS	39
Operation screen of SRS.....	39

List of SRS operations.....	40
List of SRS buttons	40
List of clicker operations.....	46
Starting SRS.....	47
From posing a question to close the question.....	49
Finishing SRS.....	55
Group learning.....	56
Review of the session.....	59
Giving an award.....	60
Utilizing the collected data	61
Using Result Display Software	61
Starting the software.....	61
Displaying the Session report.....	62
Output the personal report	66
Saving in other formats	67
Various Settings	68
Wireless setting for the clicker.....	68
Image Mate Accent for SRS Configurations.....	69
Starting the software.....	69
Description of menu tabs.....	69
Settings	70
SRS Settings.....	71
Software update	73
About.....	74
SRS Data Settings.....	75
Starting the software.....	75
Check the connection.....	77
Battery level	78
Clicker Information	79
Register students information.....	80
Let's take photos!	81
Database Settings	82
Create Database	82
Select Database.....	83
Edit Database Profile.....	84
Adding or Changing the clicker.....	85
Other Function.....	87
About LED	87
Clicker	87

Wireless adapter	88
Troubleshooting	89
Specifications	90
Product specifications.....	90
System Requirements	91
Disclaimer.....	92
About Trademarks	92
Repairable Period.....	92

Before Use

Thank you very much for purchasing Student Response System CRV-24/32 (SRS).
Please read this manual carefully to ensure proper use of SRS.

For the effective use of the questions and the collected data, please have your students always use the same clicker by associating each of your students with the unique serial number printed on the back of their clickers.

We recommend you to register the students to use SRS in advance.



All functions of SRS are controlled by Elmo's Image Mate Accent for SRS.

Image Mate Accent for SRS is designed to allow you to operate SRS functions in addition to the Pen Tablet functions, which are the basic features of Image Mate Accent (IMA).

※For details about the operations of the Pen Tablet, refer to the User's Guide of ELMO Wireless Slate / Tablet.

※Functions of Image Mate Accent can also be used when a mouse is used instead of the Pen Tablet. For details about the operation using a mouse, refer to 〈**About Image Mate Accent**〉.



Caution

- When you use SRS with Elmo Pen Tablet CRA-1, the wireless settings between the wireless adapter of SRS and the tablet need to be set up. For details about the set up procedure, refer to the User's Guide of ELMO Wireless Slate/ Tablet.
- Do not use the wireless adapter supplied with the Pen Tablet. Use the wireless adapter supplied with SRS.
- Firmware of the tablet may need to be upgraded. For further information, contact the dealer from whom you have purchased this product or one of our sales offices whose details are provided at the end of this manual.



Caution

Please note that screens and figures used in this manual may differ from the actual views.

Main functions

■ Pose questions, collect responses and display the results.

With SRS, you can collect responses from all students in the class by using clickers.

Collected responses can be saved and displayed in graphs.

The overall proficiency of the class can be assessed with multiple-choice questions.

Majority Testing by Yes or No question can be easily performed.

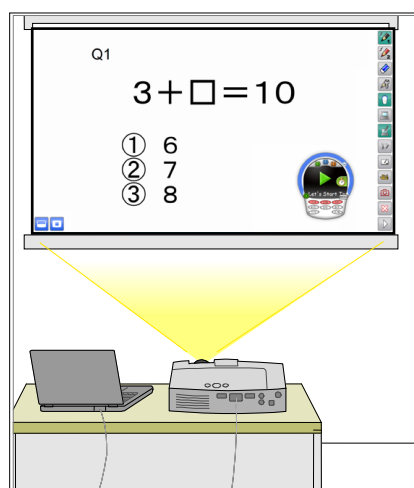

■ Utilize the collected data

The collected data is automatically stored on the users computer and can be converted to standard formats. These standard files can be shared with other computers.

■ Manage the clicker

You can add/ delete a clicker or display the battery level.

■ Use with the Document Camera or the Pen Tablet

You can pose a question on the spot by using ELMO Document Camera or Pen Tablet (sold separately) .

Supplied Items

Product's package has the following contents. Contact your dealer if any of the following items are not included in the package you purchased.

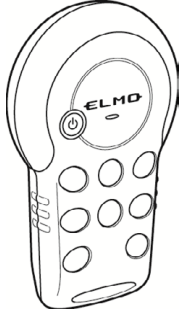

Clicker: CRV-CK-1
CRV-24: 24pcs.
CRV-32: 32pcs.

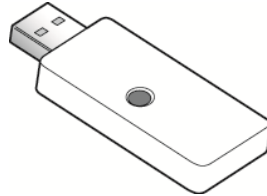

Wireless adapter
CRV-CK-1R

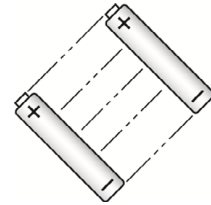

Dry cell AAA battery
(For the clicker)
CRV-24: 48pcs.
CRV-32: 64pcs.



Screw driver for M3
(For the back cover of the
clicker)

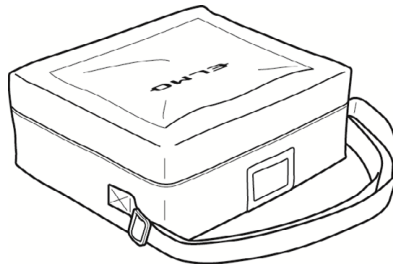

Carrying Case

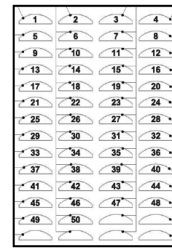

Seal clicker no.
(Clicker number sticker sheet)



Before use



Application software
(CD-ROM)

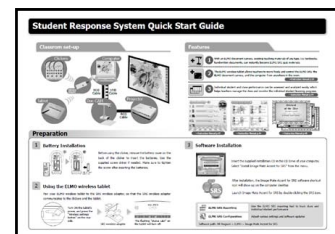

Quick Start Guide

Part Names

■ Clicker

Front

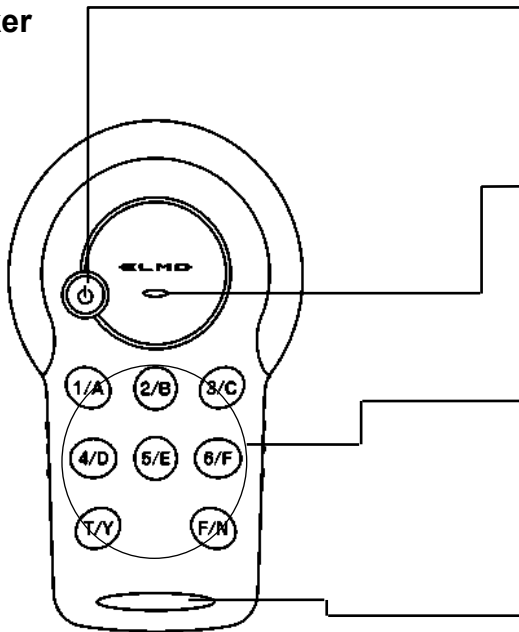

Power button

Turns ON / OFF the clicker.

Press this button for 3 seconds or longer to turn OFF the clicker. See <Starting SRS> .

Power LED

Indicates the battery charge status.

The LED lights up when the clicker is turned on and begins flashing when the battery level is low. See <About LED> .

Response button (1~6,T/F)

Students can respond to questions using 1(A) ~6(F) and T(Y)/F(N) buttons.

The last pressed button lights up or flashes for 5seconds. See <About LED> .

Strap hole

For attachment of a commercially available strap.

Back

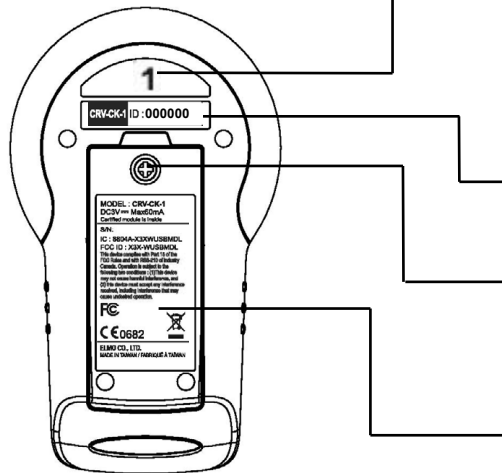

Student number (Clicker number)

By default, a sticker with a number from 1-24 (or 32) is attached.



The supplied clicker number sticker can be attached.

Device ID

ID number of the clicker.

Battery box cover fixing screw

Use the supplied screw driver to tighten the fixing screw.

Battery box cover

Use the fixing screw to open/close the cover.



Be careful not to lose it.
Only open when absolutely necessary.

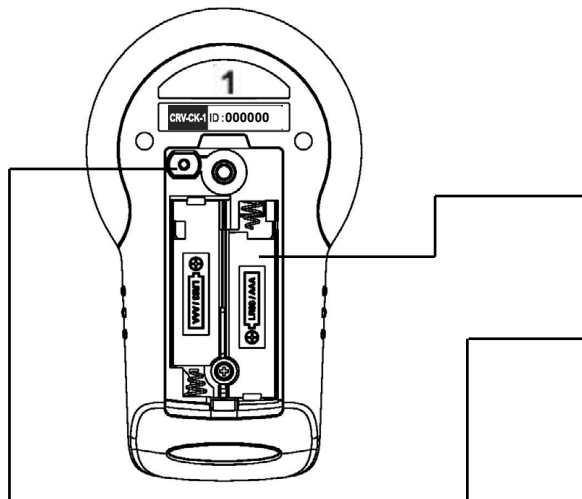

Battery box

Insert the alkaline dry cell AAA batteries. See <Insert the batteries into the clicker> .

Wireless setting button

Use this button when configuring the wireless connection setting with the wireless adapter. Open the battery box cover when performing the configuration.

See <Wireless setting for the clicker> .

■ Carrying Case

Outside

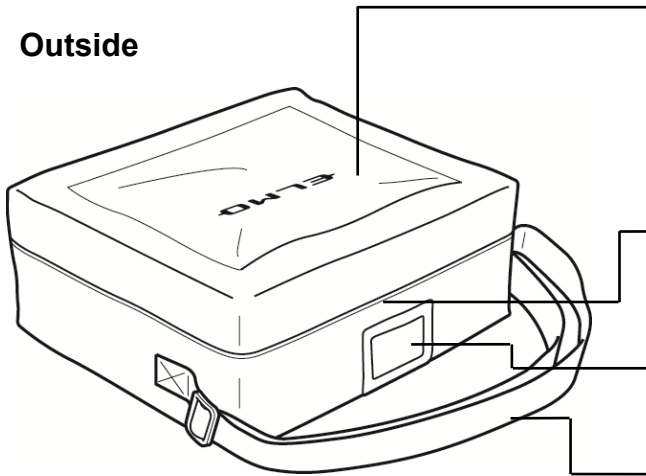

Cable Storage Pocket

Storage for the RGB/USB composite cable supplied with the separately sold Pen Tablet or commercially available RGB cables or USB cables.

Double zipper

The top of the bag opens 180 degrees.

Name holder

Name card and the like can be inserted.

Shoulder belt

The length can be adjusted.

Inside

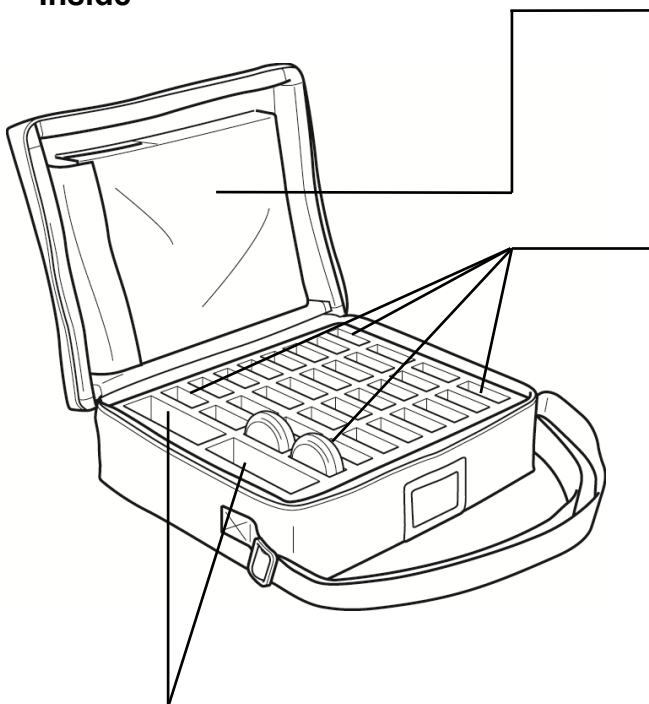

Pen Tablet storage

Stores the Pen Tablet. It can be secured with Velcro tape.

Clicker compartments

Stores clickers vertically as shown in the picture.

Max.32pcs of clickers can be stored.

Upper part of the clicker is slightly out of the compartment for easier handling.



Caution

Store 1 clicker in each compartment.

Accessory storage

Stores accessories such as the wireless adapter and a screw driver.



Caution

Be careful not to lose the accessories when you open the zipper.

Preparation

Insert the batteries into the clicker

Before you use the clicker, remove the battery box cover on the back of the clicker together with the fixing tape to insert the batteries. In case it is difficult to remove the cover, use the supplied screw driver to loosen the battery box cover fixing screw. Make sure to attach the cover after inserting the batteries and tighten the fixing screw.

Dispose of the tape after removal.

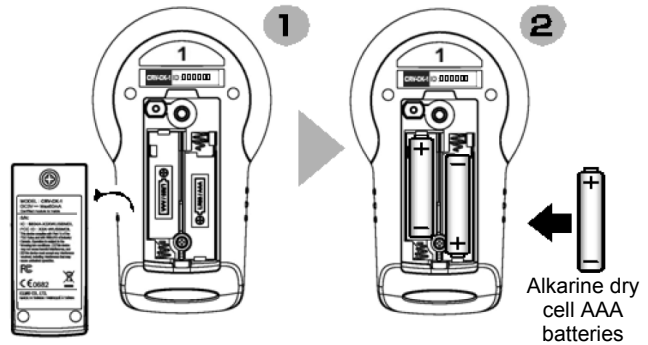

Caution

- Make sure that the polarity (+/-) of the dry cell battery is correct.
- Remove the dry cell battery if the clicker will not be used for a long time.
- Do not recharge or short-circuit the dry cell battery.
- Use an alkaline dry cell AAA battery. Do not use a rechargeable battery (such as Ni-Cd).
- The supplied dry cell battery is for an initial operation check. Its operating life is not guaranteed.
- Replace the lid and tighten screw of the battery box after inserting the batteries.
- Do not mix old and new batteries or ones of different types.
- When disposing of used batteries, follow the instructions from your local government.

<Time for replacement of the batteries>

When the battery level is low, operational performance may be degraded. Replace the batteries when the power LED begins to flash during power ON or after sending a response.



Caution

- Be careful when replacing the battery as they because it may pop out.
- Replace the batteries at least once a year.

Attach the clicker number sticker (if necessary)

Attach the clicker number sticker supplied with this product.

When using a blank sticker, write a desired number on it.



By default, a sticker with a number from 1-24(or 32) is attached.

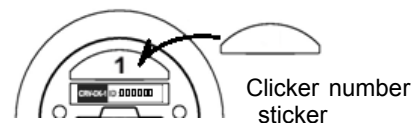

Software installation

All functions of SRS are controlled by Image Mate Accent for SRS.

Install the software before initial use of the SRS.

For details about the installation procedure, refer to “Before use” and the following instructions:

■ Windows

- ① Insert the supplied CD-ROM to the CD-ROM Drive of your computer.
- ② Select “Install Image Mate Accent for SRS” in the menu.

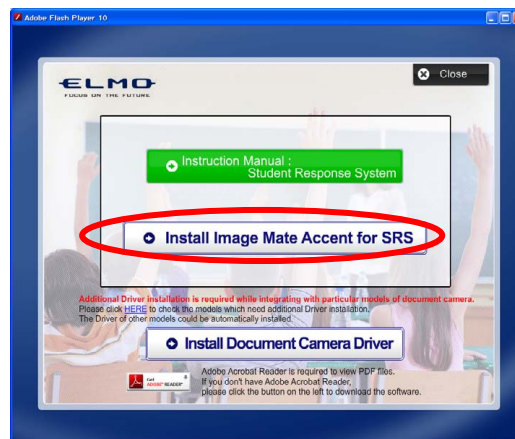

Caution

Depending on your computer, the menu may not appear automatically.

In that case, open the drive where the supplied CD-ROM is inserted from My Computer and double-click “startup.exe” in the Win folder.

- ③ Follow the displayed instructions to install.
- ④ When the software is successfully installed, “Image Mate Accent for SRS” icon appear on the desktop.

■ Macintosh(Mac)

- ① Insert the supplied CD-ROM to the CD-ROM Drive of your computer.
- ② Select “Mac” in the CD-ROM. Then run “ELMO_IMAforSRS.dmg”.
- ③ The launcher is displayed.
- ④ Run “Install Image Mate Accent for SRS”.
- ⑤ Follow the displayed instructions to install.
- ⑥ When the software is successfully installed, “Image Mate Accent for SRS” icon appears on the desktop.
- ⑦ Run “ELMOUSBDriver_1.0.0.pkg”.
- ⑧ Follow the displayed instructions to install



Caution

Depending on your computer, you may be asked to restart the computer. In that case, press “YES” o restart the computer.

Connecting the wireless adapter

Connect the supplied wireless adapter to your computer's USB port.

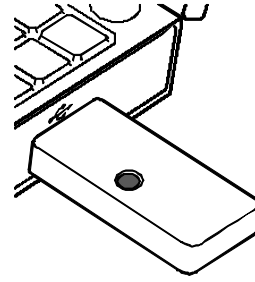

Launching Image Mate Accent for SRS

Launch Image Mate Accent for SRS launcher by double-clicking the shortcut icon created on the desktop of your computer.

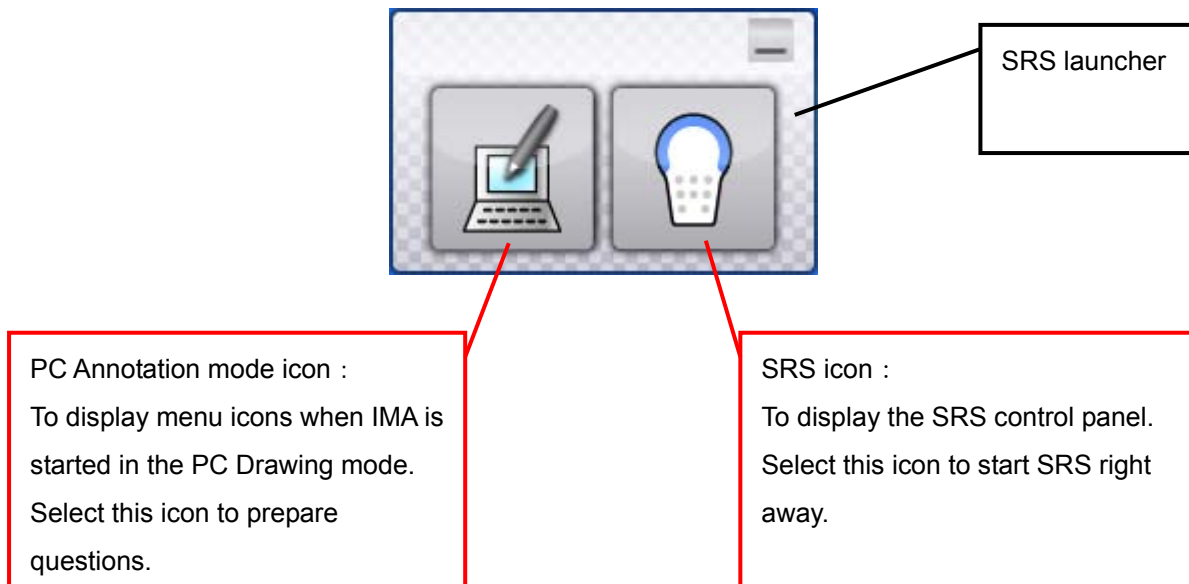

 **Note**

The SRS icon cannot be selected when the wireless adapter that supports SRS is not connected.
The SRS control panel can also be displayed from the SRS icon in the IMA menu icon.

Database Selection

In case there are several databases, a database selection window appears when the PC Annotation Mode icon or the SRS icon is selected for the first time after starting the Image Mate Accent for SRS. In that case, please select the database to use.

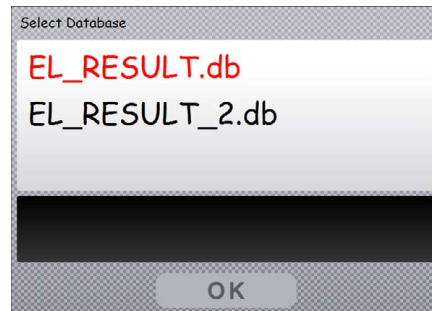

Selected database turns to red. Press [OK] to confirm the database.
The software enters the PC Annotation mode or the SRS mode.



The database set as default database through “Select Database” is displayed in red first.
See <Database Settings>

About Image Mate Accent

In this section, you will learn various operation modes of Image Mate Accent (IMA) that can be used through Image Mate Accent for SRS and how to draw lines with mouse.

Basic Screen

Basic Screen Configuration

This section describes the basic configuration of the screen that is displayed when using the SRS.

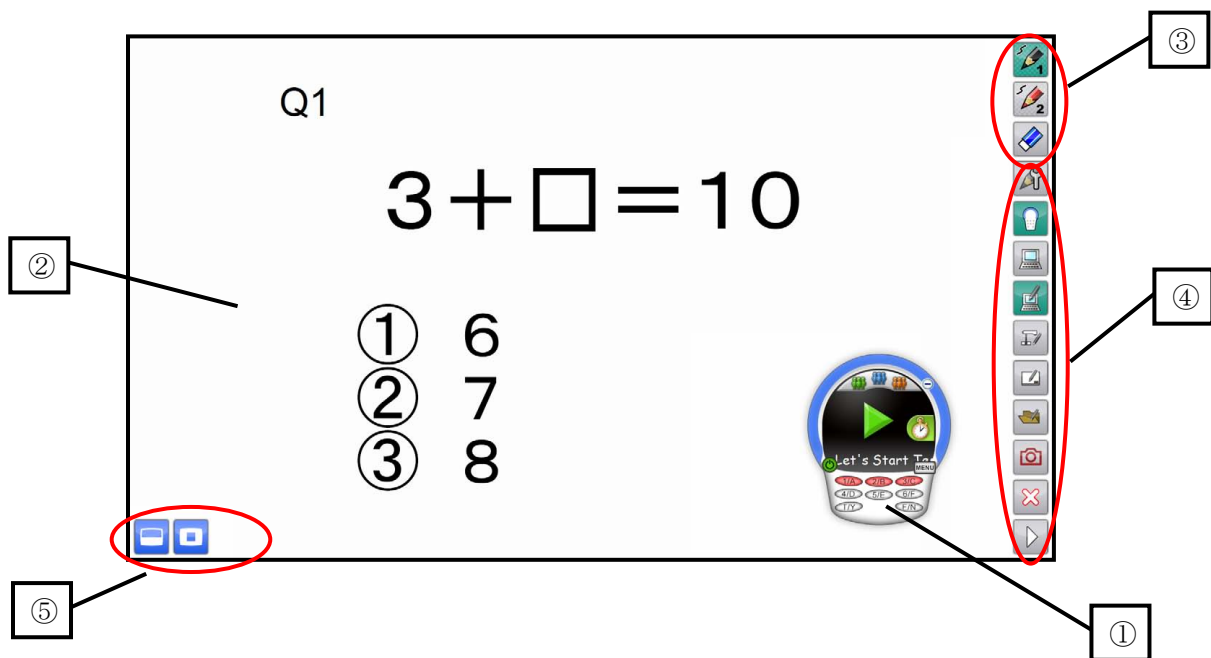

■ Startup screen of the SRS software (Image Mate Accent for SRS)

①	SRS control panel	From this window, you can operate SRS. See <List of SRS operations> .
②	Drawing area	This area is for displaying the Document Camera image and drawing. The entire monitor is the drawing area.
③	Drawing menu area	You can select the pen to use for drawing, or delete all drawings. See <List of Menu icons> .
④	Menu area	These buttons are for configuration or operation of the Document Camera. See <List of Menu icons> .
⑤	Sub Menu area	These buttons are for advanced operations. The buttons to be displayed varies depending on the mode. See <List of Menu icons> .

Various Operation Modes

This section describes various operation modes of Image Mate Accent.

Diagram of the modes

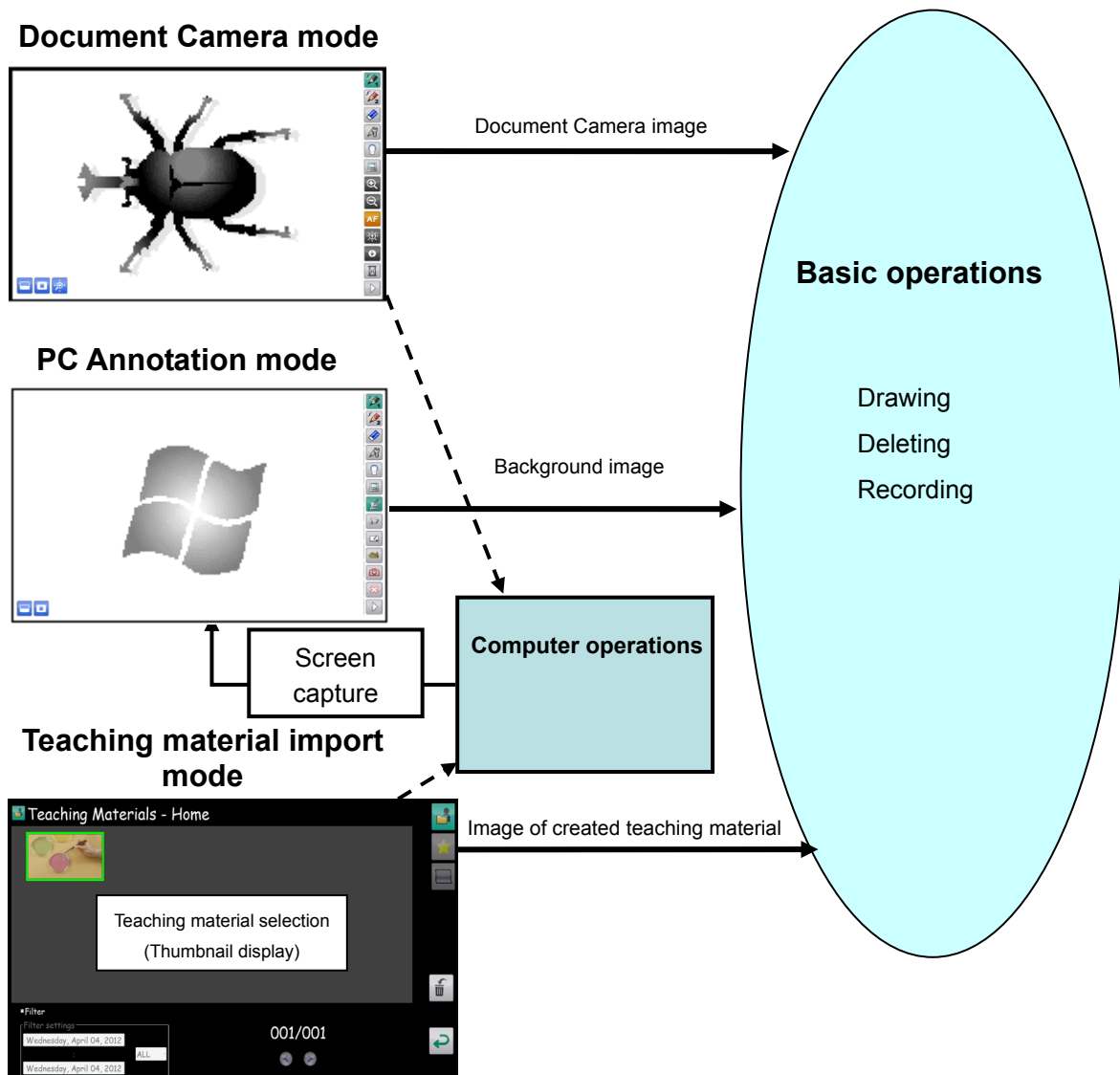

As shown above, the basic operations (drawing, deleting and recording) are performed for the Document Camera image in "Document Camera mode", for the background image in "Whiteboard mode", and for an already-created teaching material in "Teaching material import mode".

Computer operations or displaying the SRS control panel can be possible from any of these modes.

PC Annotation Mode

In the PC Annotation mode, you can draw over the computer screen or save the drawing as a picture. Click  to enter the PC Drawing mode.

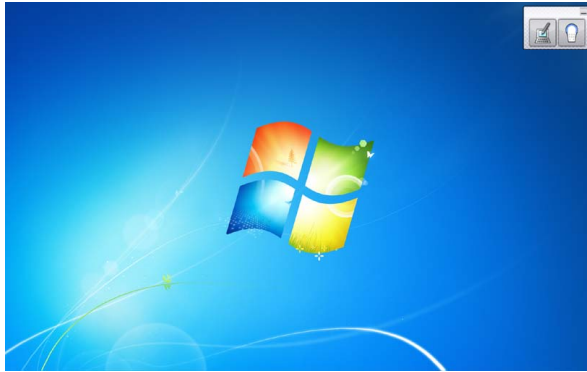

PC Operation Mode

In the PC Operation mode, you can operate your computer. This mode is used to change the background for the PC Drawing mode or pose questions with SRS.

Click  to enter the PC Operation mode.

Document Camera Mode

In Document Camera Mode, you can draw on the Document Camera image or save the drawing as a picture.

Click  to enter the Document Camera mode.

Whiteboard Mode

In the Whiteboard mode, you can set a whiteboard image as the background and draw over it or save the drawing as a picture.

Click  to enter the Whiteboard mode.

Teaching Material Import Mode







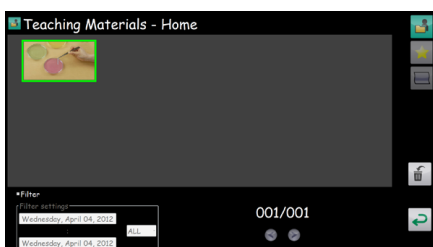

In the Teaching material import mode, you can view pictures that you have recorded in advance. Click  to enter the Teaching material import mode.

■ Selecting Pictures

Select a picture that you want to view from the list of saved pictures.



Pictures are displayed in order of last updated date.

 Page	Any picture that cannot be displayed in a single screen will be displayed in the next page(s).
Enable Filter	To enable the filter.
Filter Setting	To filter the pictures to be displayed. The pictures created between the start date and the end date are displayed.
(Drop-down list)	To select the file format of the picture.
 Home	To display all the pictures in CONTENTS SELECT screen.
 Favorite	To display the pictures set as Favorite in CONTENTS SELECT screen.
 Background	To display the pictures to be used as background.
 Deletion	To delete the selected pictures. The deleted pictures are moved to the Recycle Bin of the OS.
 Cancel	To cancel the teaching material selection and returns to the previous mode.
 Background Shortcuts	To register up to 4 background pictures to the menu of IMA as shortcuts.
 Background Shortcuts Display button	To show/hide the background shortcuts (1-4). This button appears on the right bottom of the screen only when the Background button is pressed.

■ Setting a picture as Favorite

Drag & drop a picture to  from the CONTENTS SELECT screen.

■ Setting a picture as Background

Drag& drop a picture to  from the CONTENTS SELECT screen.

■ Register the background shortcuts

Press the Background button  to show a list of background pictures.

Press the Background Shortcuts Display button  to show the background shortcuts 1 -4.

Drag& drop a picture that you want to set as background to the shortcut area of desired number (1-4).

A background picture registered to the background shortcut is displayed at the first of the list of the background pictures with a shortcut number. The registered background picture can be overwritten by another picture by drag and drop.

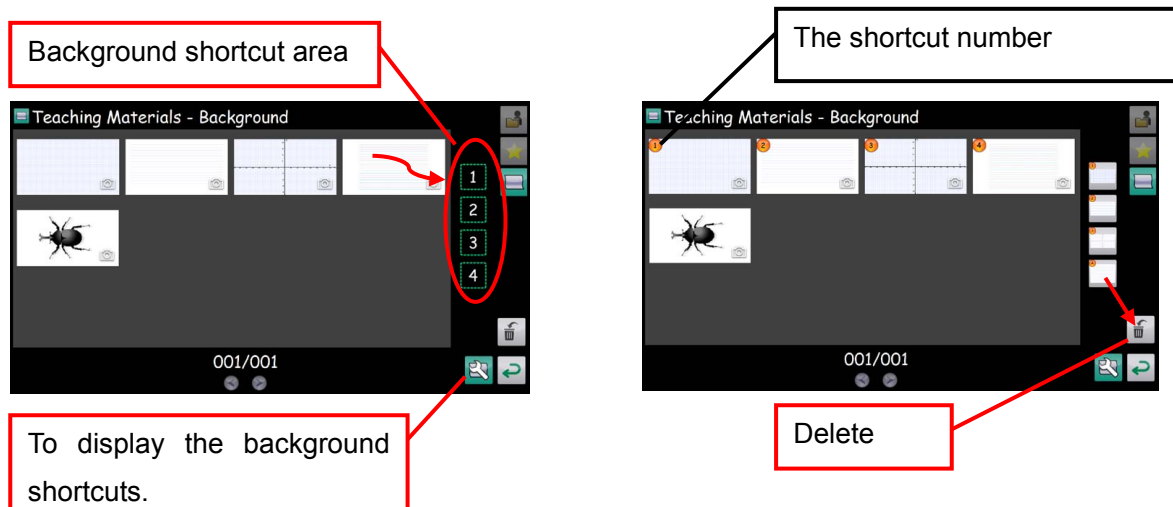

The software enters the Whiteboard mode after the cancel button is pressed and the newly registered background shortcut icon flashes for a certain period of time.(Menu Icon List)

To remove the shortcut, drag and drop the picture from the background shortcut area to the list of background pictures or to  .



Drag and drop from the background shortcut area to  does not delete the original background files in your computer.





■ Deleting a picture

Drag and drop a picture to  from the CONTENTS SELECT screen or click  after selecting a picture from the CONTENTS SELECT screen.

Drawing Operation

This section describes how to draw lines with mouse.

Drawing

- Select the desired pen icon  or  in the menu on the top right of the screen.
- 1** Select  to draw a red line, and select  to draw a black line. The initial setting is “pencil (red)” for Pen1 and “pencil (black)” for Pen2.



The pen types and the line types can be changed in the pen settings. See <Setting the Pen>.

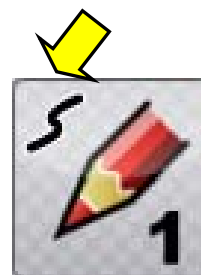
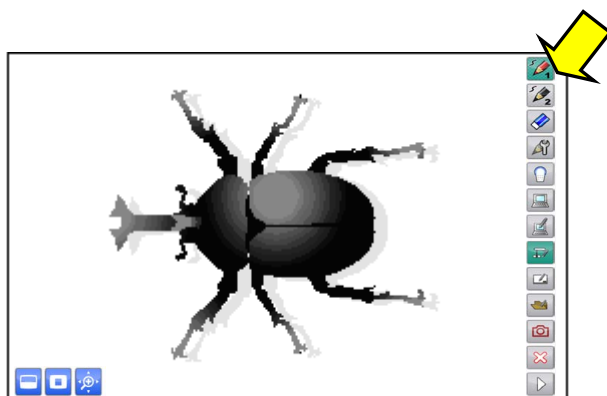

- 2** Draw lines by moving a mouse while pressing the left button of the mouse.

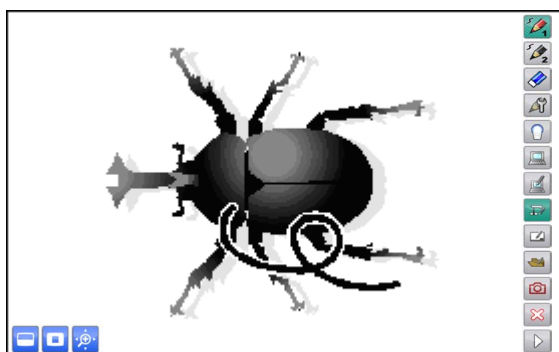

Deleting

■ Partial deletion

If you only want to delete part of a drawing, align the cursor with the area that you want to delete, and move the mouse while pressing the right button of the mouse.



You cannot partially delete a line that was drawn continuously.

■ Delete all

Select  to delete all the lines on a screen.

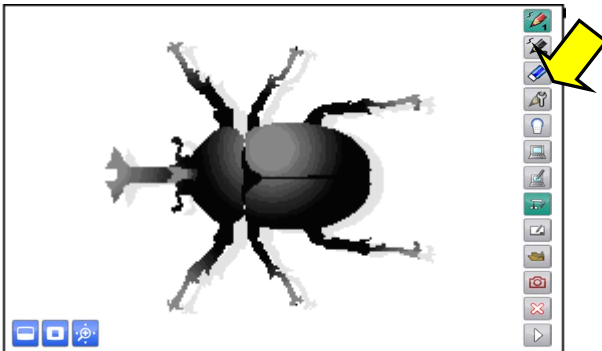

Recording a Lesson

■ Saving a picture

1 Display the image that you want to save as a picture.

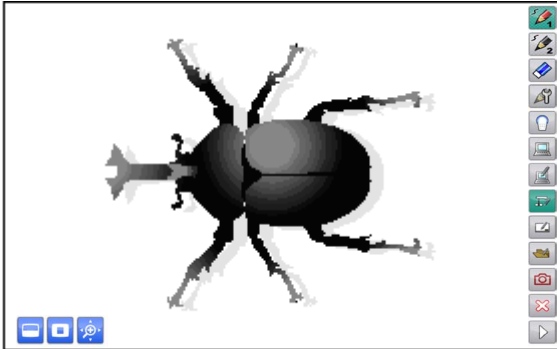

2 Select  to save the picture.

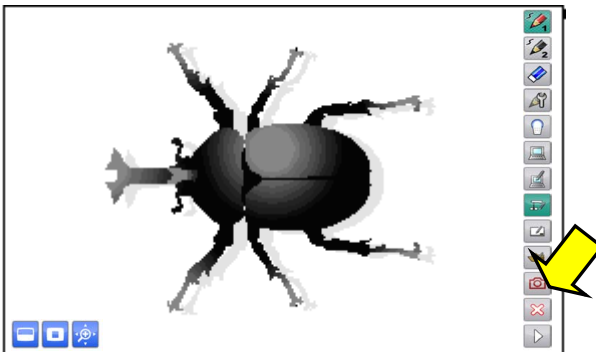

Caution

· For information on how to check the saved picture, see [〈Selecting a Teaching Material〉](#) .

■ Recording a video

1 Display the image that you want to record as a video.

2 Select  on the main menu.

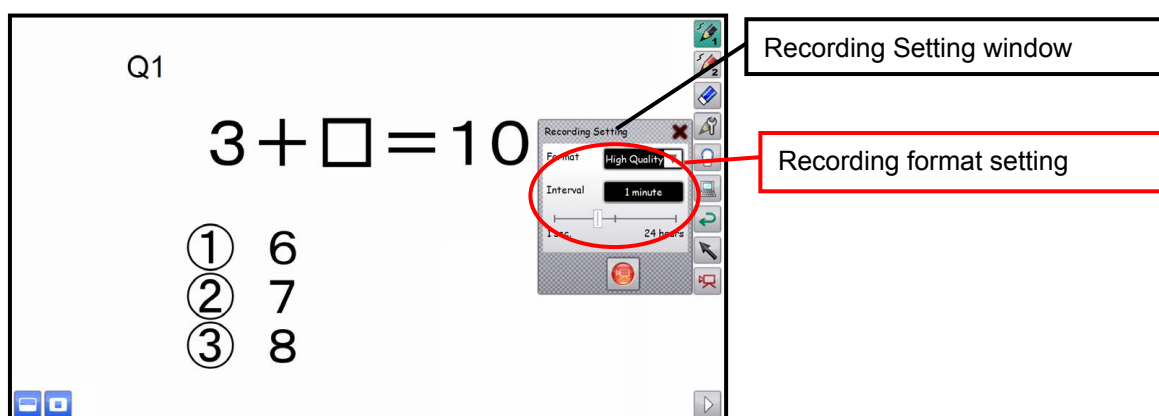

The Recording Setting window appears. The recording format can be selected between High (H.264) and Standard (MJPG).

An interval recording system is used for the recording. The recording interval can be set from 1 second to 24 hours.







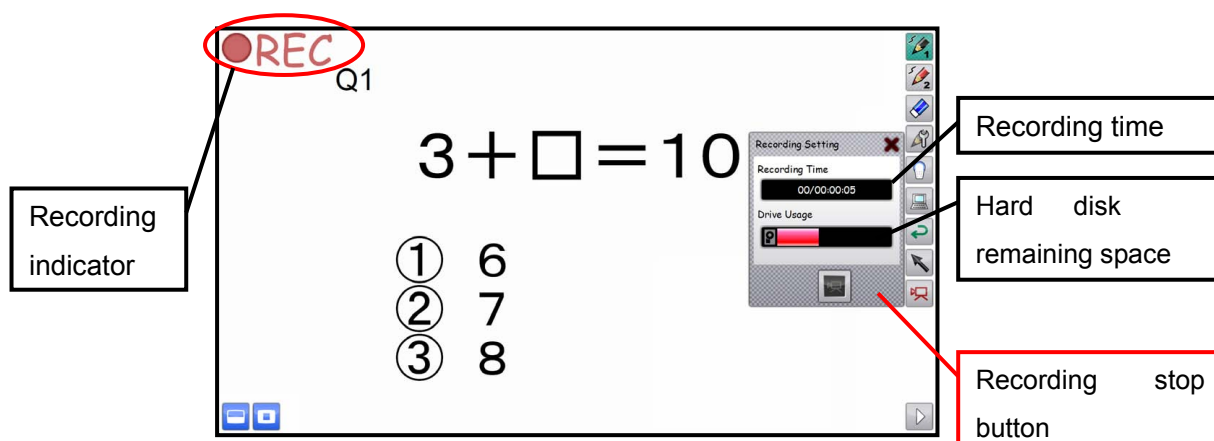

3 Select the recording start button  in the Recording Setting window to start the recording.

4 Select the recording stop button  to stop the recording.

To stop the recording, select the recording button  in the menu and click the recording stop button . The recording indicator disappears.







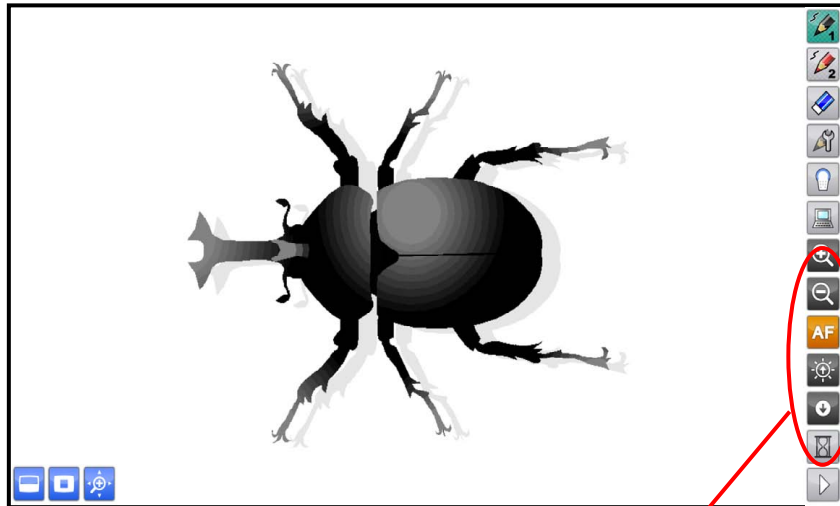

Operating the Document Camera

Operate the Document Camera by touching   ,  and   on the main menu. The presented Document Camera image can be paused by clicking  and flipped vertically by clicking  .



Document Camera operation buttons

  Zoom In/Out	To control the zoom level of the Document Camera.
 Auto Focus	To focus the Document Camera automatically.
  Brightness Up/Down	To adjust the brightness of the Document Camera.
 Pause	To pause the Document Camera image.
 Image flip	To flip vertically the Document Camera image.

Note

The image flip icon can be shown by moving to the next page of the menu with  .

Mask Function

The mask hides part of or whole Document Camera image that is displayed.

By temporarily hiding part of the image that you do not want to show while asking questions or giving explanation, your lessons will become more effective.



Select  on the sub menu.

The entire screen is masked. Adjust the size of the mask by dragging it.

When the mouse cursor reaches the edge of the screen, it will not go further.

In that case, release the mouse cursor and restart the dragging from the upper position.

The mask size can be changed from 100 x 100 pixels to the size of the screen.

The darkness of the mask can be adjusted with  and .

The darkness of the mask increases when  is pressed.

The darkness of the mask decreases when  is pressed.

To cancel the mask, touch  on the sub menu again.

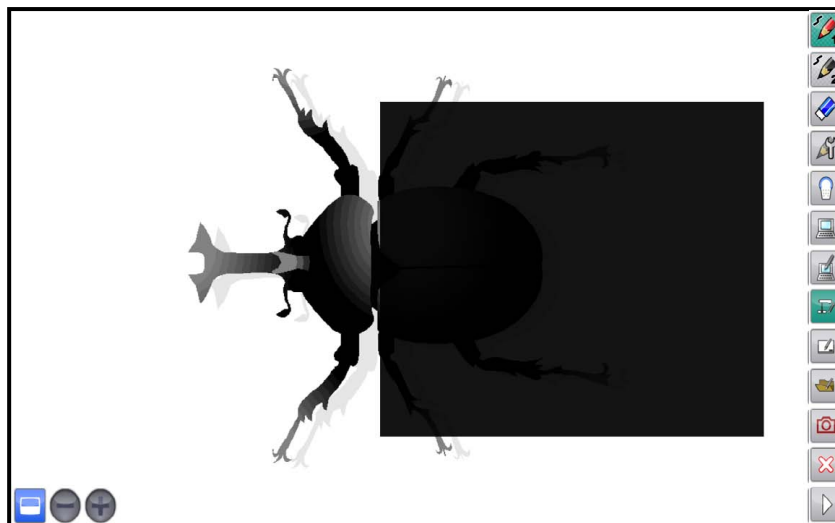

Highlight Function

The highlight function brings attention to a part of the Document Camera image.



By highlighting only the area you want to bring to attention, your lessons will become more effective.

Select  on the sub menu.

The highlighted area is displayed on the screen. Drag the highlighted area to move it.

You can change the size of the highlighted area by dragging the non-highlighted area.

The highlight size can be changed from 100 x 100 pixels to the size 300 pixels smaller than the screen size.

The darkness of the non-highlighted area can be adjusted with  and  .

The darkness of the non-highlighted area increases when  is pressed.

The darkness of the non-highlighted area decreases when  is pressed.

To cancel the highlight, select  on the sub menu again.

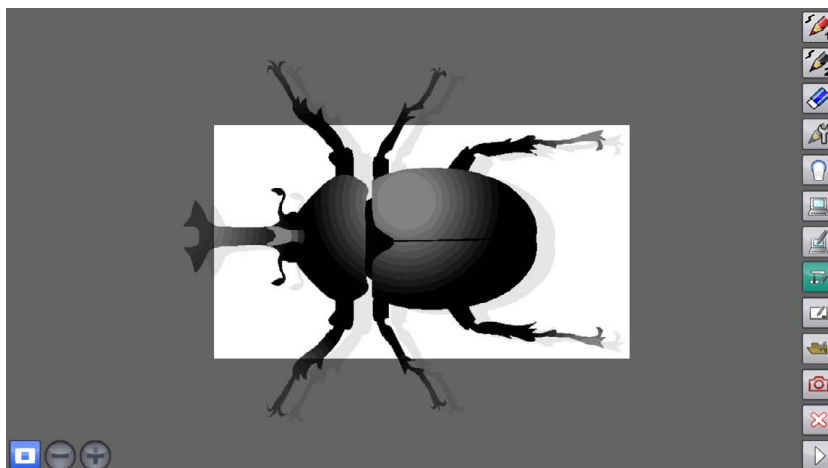

Scroll Function

The scroll function enlarges the Document Camera image.

By temporarily enlarging a small part and moving the image with the pen, your lessons will become more effective.

Select  on the sub menu.

An electronically magnified image is displayed on the screen. Drag the image to move it.

To cancel the scroll, select  on the sub menu again.

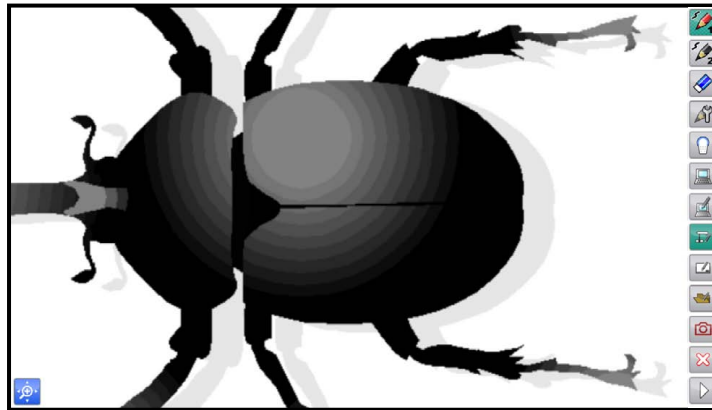



The scroll function cannot be operated in the PC Annotation mode.

Using PowerPoint Support Function

Start PowerPoint while the Image Mate Accent for SRS is running.

Start slideshow in PowerPoint. Then set the Image Mate Accent for SRS to the PC Annotation mode or the SRS mode.

The PowerPoint Support icon appears in the bottom left of the screen.

You can move to the previous page by pressing  or to the next page by pressing .

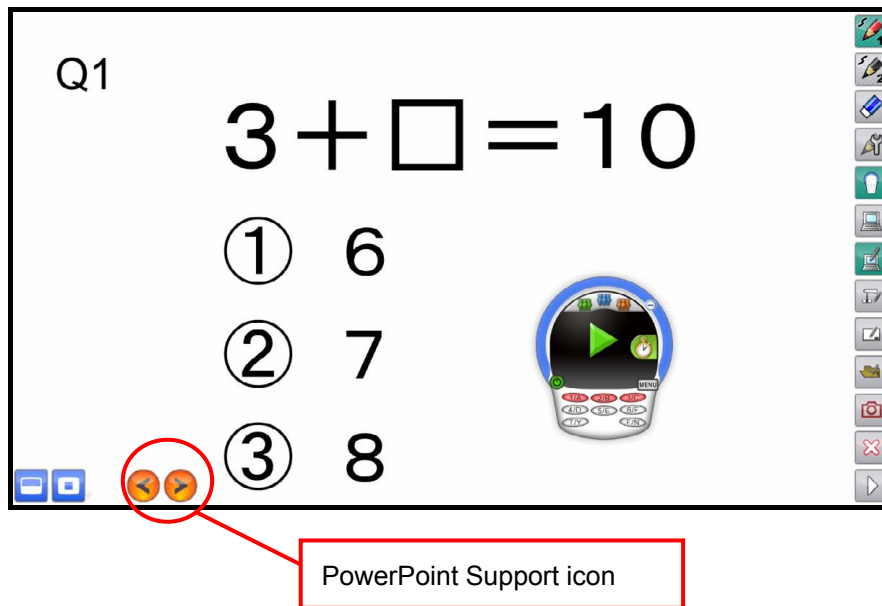



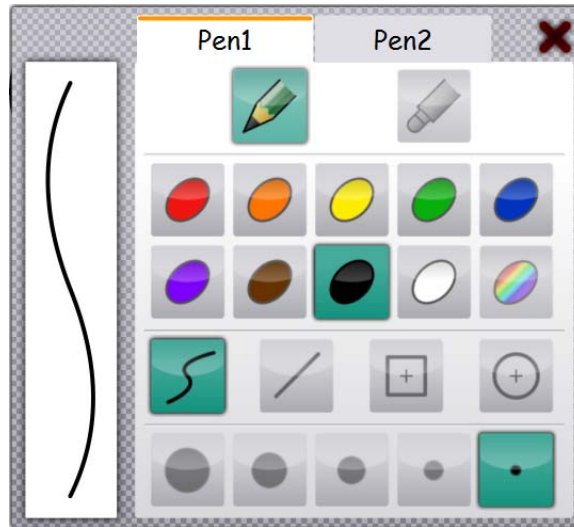

The PowerPoint Support function does not support PowerPoint Viewer.

Setting the Pen

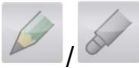













- 1 Select  to display the pen settings.



















 Pen 1 / Pen 2	To select the pen that you want to configure .								
 Pencil / Marker	To select a type for the selected pen. <table border="1" data-bbox="603 1173 1310 1305"> <tbody> <tr> <td>Pencil</td> <td>Draw a line with the set line thickness.</td> </tr> <tr> <td>Marker</td> <td>Draw a line with the set line thickness. The colors are displayed semi-transparently.</td> </tr> </tbody> </table>	Pencil	Draw a line with the set line thickness.	Marker	Draw a line with the set line thickness. The colors are displayed semi-transparently.				
Pencil	Draw a line with the set line thickness.								
Marker	Draw a line with the set line thickness. The colors are displayed semi-transparently.								
 Color button	To configure the color for the selected pen.								
 Line type	To select a line type for annotations. <table border="1" data-bbox="603 1503 1366 1680"> <tbody> <tr> <td>Free-hand</td> <td>Draw a free-hand line.</td> </tr> <tr> <td>Straight</td> <td>Draw a straight line.</td> </tr> <tr> <td>Square</td> <td>Draw a square shape.</td> </tr> <tr> <td>Circle</td> <td>Draw a circle.</td> </tr> </tbody> </table>	Free-hand	Draw a free-hand line.	Straight	Draw a straight line.	Square	Draw a square shape.	Circle	Draw a circle.
Free-hand	Draw a free-hand line.								
Straight	Draw a straight line.								
Square	Draw a square shape.								
Circle	Draw a circle.								
 Pen thickness	To configure the thickness for the selected pen.								

- 2 Select the pen type, color and pen thickness for pen 1 or pen 2, and then select OK.

List of Menu icons

 Pen 1	<p>To select pen 1. The initial setting is a red pencil. You can change the settings for this pen in "Pen Settings".</p>
 Pen 2	<p>To select pen 2. The initial setting is a black pencil. You can change the settings for this pen in "Pen Settings".</p>
 Delete all	<p>To delete all the lines that are drawn on the screen. If you only want to delete part of a drawing, align the cursor with the area that you want to delete, and move the mouse while pressing the right button of the mouse. See <Partial deletion> .</p>
 Pen settings	<p>To display the settings for pen 1 and pen 2. See <Setting the Pen> for more details.</p>
 SRS mode	<p>To enter the SRS mode.</p>
 Computer operations	<p>To operate the computer.</p>
 PC Annotation mode	<p>To enter the PC Annotation mode.</p>
 Document Camera mode	<p>To enter the Document Camera mode.</p>
 Whiteboard mode	<p>To enter the Whiteboard mode.</p>
 Teaching material import mode	<p>To enter the Teaching material import mode.</p>
 Capture	<p>To save the currently displayed contents as a picture. Elements such as the Document Camera image that is displayed on the background, the background image and the drawn lines are recorded, but elements such as the buttons and cursor are not recorded. The pictures can be displayed in " Teaching material import mode".</p>
 Quit	<p>To quit the software (Image Mate Accent for SRS)</p>
 Next	<p>Displayed when the whole menu cannot be displayed on one screen. Use this button to go to the next menu. When the final menu is displayed, touch this button to return to the first menu.</p>

 Undo	<p>To redo the last editing operation (such as drawing with the pen or deleting with the eraser). There is a limit on the number of operations that can be undone.</p>
 Select	<p>To change the pen to a pointer.</p>
 Record	<p>To record the contents displayed on the screen as a video. An interval recording system is used for the recording. The recording interval can be set. The background image such as the Document Camera image and the drawn lines can be recorded. Buttons and the cursor cannot be recorded.</p>
 Image Flip	<p>To flip vertically the Document Camera image.</p>
 Zoom In/Out	<p>To control the zoom level of the Document Camera.</p>
 Auto Focus	<p>To adjust the focus of the Document Camera automatically.</p>
 Brightness Up/Down	<p>To adjust the brightness of the Document Camera.</p>
 Pause	<p>To pause the Document Camera image.</p>
 Background Shortcuts	<p>To display the registered background shortcuts. 4 background pictures which were registered in the Teaching Material Import mode can be saved as shortcuts.</p> <div style="border: 1px solid black; padding: 5px; margin-top: 10px;">  <p>The favorite pictures are registered by default. Change as you prefer.</p> <p>Caution</p> </div>
 Last used background	<p>To display the last used background.</p>
 Mask	<p>To hide part of or whole Document Camera image that is displayed. You can move the masked area by dragging it. In one operation, you can only move the mask up or down or to the left or right. When the mouse cursor reaches the edge of the screen, it will not go further. In that case, release the mouse cursor and restart the dragging from the upper position</p>

 Highlight	<p>To bring attention to a part of the Document Camera image. You can move the highlighted area by dragging it. In expert mode, you can change the size of the highlighted area by dragging the non-highlighted area.</p>
 Scroll	<p>To digitally enlarge the Document Camera image. Use it to enlarge the area that is too small.</p> <div data-bbox="711 533 1366 622" style="border: 1px solid black; padding: 5px;">  <p>This is different from the zoom function of the Document Camera.</p> </div>
 PowerPoint Support Previous page / Next page	<p>To operate the PowerPoint without entering the PC Operation mode. You can move between pages of PowerPoint from the PC Annotation mode.</p>

Using SRS

Operation screen of SRS

Operations such as posing questions, giving answers and displaying the results are performed from the SRS control panel.

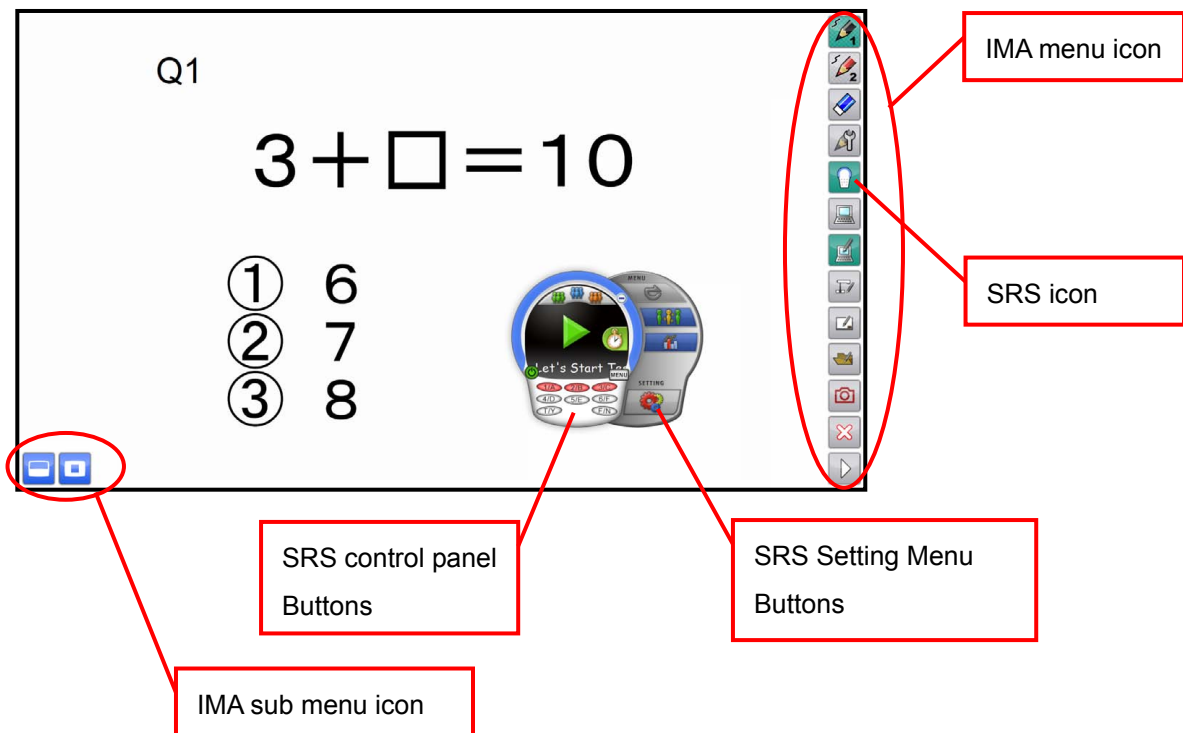







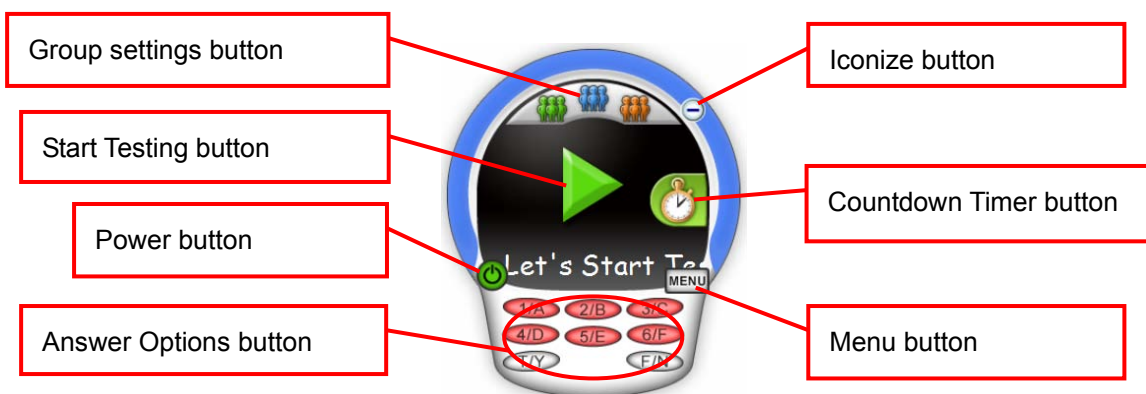

List of SRS operations

List of SRS buttons

Following command buttons in the SRS control panel are used to pose questions or display the results.





■ Before Testing (The color of the SRS control panel turns to blue.) (Starting screen)

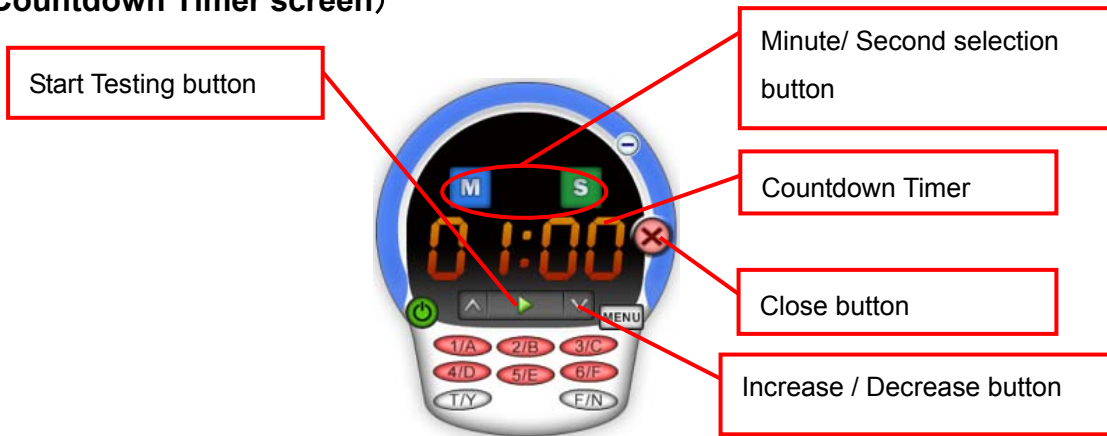

Menu button	Name	Function
	Power	To start SRS.
	Start Testing	To start receiving responses.
	Group settings	To display the Group settings. You can show the results by groups by grouping clickers in advance. See <Group learning> .
	Countdown Timer	To display the Countdown Timer. See <Countdown Timer screen> .
	Answer Options	To display the answer options currently available in red. (The drawing shows an example of 6-choice question). The current setting for the question type (2-6 choice, True (Yes)/ False (No)) can be changed using these buttons.
	Menu	To display the setting menu. (To hide the setting menu when the setting menu is on display.) See <Setting menu> .
	Iconize	To iconize the SRS control panel. Click the icon  to return to the SRS control panel.

(Countdown Timer screen)





Menu button	Name	Function
	Start Testing	To start receiving responses. The Countdown Timer starts automatically at the same time.
	Countdown Timer	To display the set time. (The drawing shows an example when the timer is set to 1 min.)
	Increase / Decrease	To increase ▲ or decrease ▼ the amount of the time on the Countdown Timer. The Minute/ Second selection button is used to change the set time. When “Minute” is selected, the set time can be changed in increments of 1 min. When “Second” is selected, the set time can be changed in increments of 10 sec. The set time can also be changed when the Countdown Timer is in operation.
	Minute/ Second selection	To switch the minute M and the second S when performing the Countdown Timer setting. The selected icon turns to green. (The drawing shows an example when “Second” is selected.) The set time can be changed using the Increase/ Decrease button.
	Close	To close the Countdown Timer to return to the Starting screen.

■ Testing is Open (The color of the SRS control panel turns to green.)

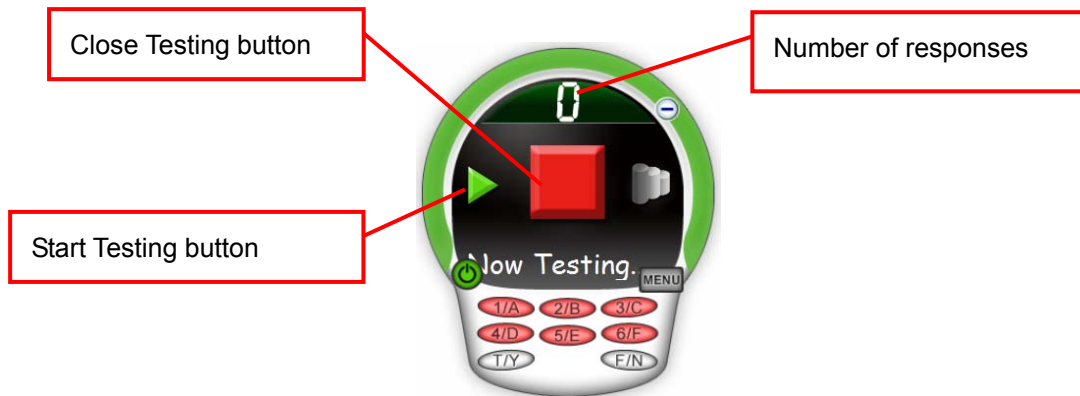





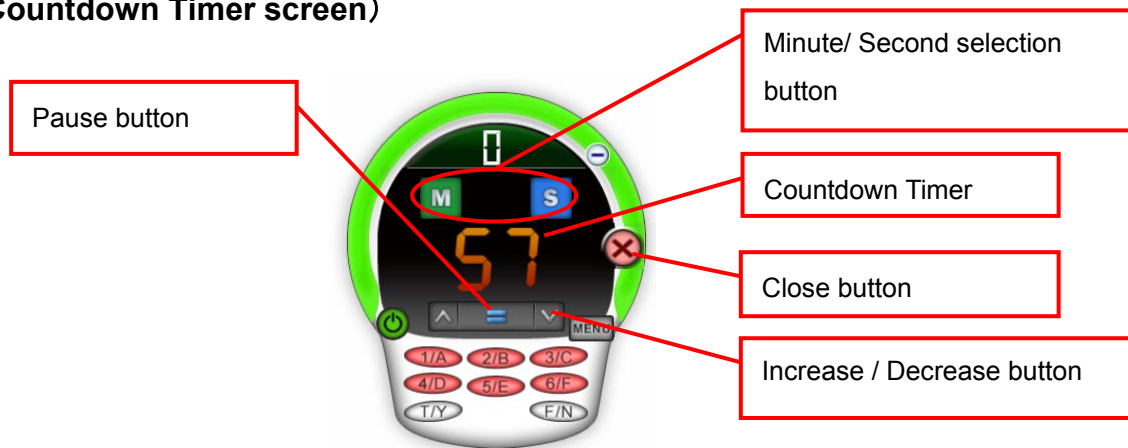

(Open Testing screen)



Menu button	Name	Function
	Number of responses	To display the number of clickers responded. By selecting this button, the unanswered clickers can be displayed.
	Close Testing	To close Testing. The results are saved as a file.
	Start Testing	To cancel the current Testing and return to the "Before Testing" status.





(Countdown Timer screen)



Menu button	Name	Function
	Pause	To pause the Countdown Timer. When this button is selected, the screen changes to "Start Testing". Select the "Start Testing" button to restart the countdown.
	Increase/ Decrease	To increase  or decrease  the amount of the time on the Countdown Timer. The Minute/ Second selection button is used to change the set time. When "Minute" is selected, the set time can be changed in increments of 1 min. When "Second" is selected, the set time can be changed in increments of 10 sec. The set time can also be changed when the Countdown Timer is in operation.
	Minute/ Second selection	To switch the minute  and the second  when performing the Countdown Timer setting. The selected icon turns to green. (The drawing shows an example when "Second" is selected.) The set time can be changed using the Increase/ Decrease button.
	Close	To close the Countdown Timer to return to the Open Testing screen. <div style="border: 1px solid black; padding: 2px; display: inline-block;">  Note </div> It is not possible to return to the Countdown Timer screen from the Open Testing screen.

■ **Displaying the results** (The color of the SRS control panel turns to blue.)
(Results screen)

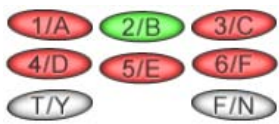





Menu button	Name	Function
	Display Results	To display the results by clicker. Return to the question screen when the results are displayed.
	Display Group Results	To display the results by group. This function is activated when the group setting is set. See <Group learning> .
	Speed Ranking	To display the response time by clicker (Speed ranking). See <Speed Ranking> . Return to the question screen when the speed ranking is displayed.
	Response	To select a correct answer. The color of the selected button turns to green. (The drawing shows an example when [2/B] is selected.)
	Start Testing	To return to the Starting screen.

■ Setting menu





Select the menu button before posing a question.



Menu button	Name	Function
	Review	To display (review) the questions and the results in the session. See < Review of the session > .
	Award	To display the Award screen. You can give awards to students who have performed well. See < Giving an award > .
	Report	To run the reporting software “SRS Reporting” in order to display the results or configure the clicker settings. See < Utilizing the collected data > .
	Settings	To run the configuration software “SRS Configurations” in order to configure the operation of the software. See < Image Mate Accent for SRS Configurations > .

List of clicker operations

These buttons are used to respond to the questions or cast a vote.

Button	Name	Function
	Power button	Turns ON/OFF the clicker. The power LED lights up when the clicker is turned on. Press the button for 3 seconds or more to turn off the clicker.
	Power LED	The LED lights up when the clicker is turned on. When the battery level is low, LED flashes for 5 seconds after the clicker is turned on and during the wireless connection.
	1/A ~ 6/F Response button	Select answers. Selected button flashes for max.7 seconds when sending a response and lights up for 5 seconds if the response is successfully accepted. (It flashes for another 5 seconds if the response is not accepted.)
	Yes or No Response button	



For details about the status of LED, refer to **<About LED>** .

Starting SRS

SRS can be started either from the respective modes in Image Mate Accent for SRS or by launching the application from your computer screen.



Refer to 〈About Image Mate Accent〉 for details about modes and operations other than SRS functions.

1 Display the SRS control panel.

Press the SRS icon  to display the SRS control panel.

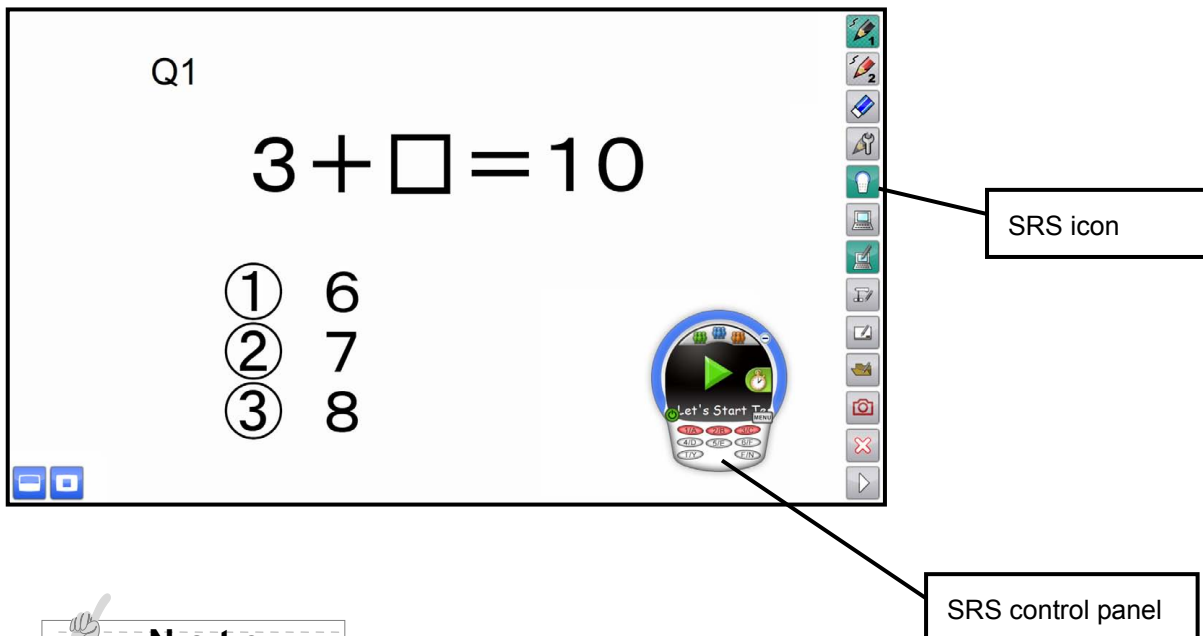

If no clicker are registered to the wireless adapter, the SRS icon will not display.

2 Turn on the clicker.

Press Power button  to turn on the clicker. The power LED lights up and the clicker attempts to establish the wireless connection with your computer.



When the battery level is low, the power LED flashes for 5 seconds.
In that case, replace with new batteries.

The clicker automatically enters standby status when there is no wireless communication.
(Pressing any button will resume the operation.)

After a certain period of time has elapsed in standby status, the power automatically goes off.
The time to power off can be changed with **<Image Mate Accent for SRS Configurations>** .
Default setting is 300 seconds.

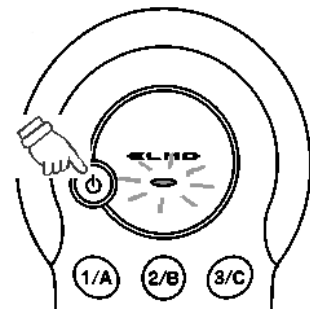

From posing a question to close the question

Pose a question using the Document camera or your computer screen. Then open Testing by selecting the Start Testing button in the SRS control panel or one of “[2]~[6],[T/F]” buttons in the Response Sub Buttons.

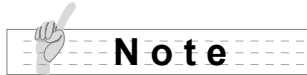

The entire process from starting Image Mate Accent for SRS to finishing it is called “session” and the results of each session are saved.

1 Pose a question.

Pose a question using the Document camera or your computer screen.



You can use the annotation function when the system is not in the “Testing is Open” status.

2 Open Testing to receive responses from clickers.

When “Start Testing” button ► is selected, Testing starts with current question type. (Default setting: 3-choice question).

The question type can be changed using the Response buttons ([2]~[6],[T/F]) before pressing the “Start Testing” button.

E.g.) When [3]  is selected, the question type becomes 3-choice question and the color of [1] – [3] buttons turns to red.

The color of the SRS control panel turns to green when Testing is started.

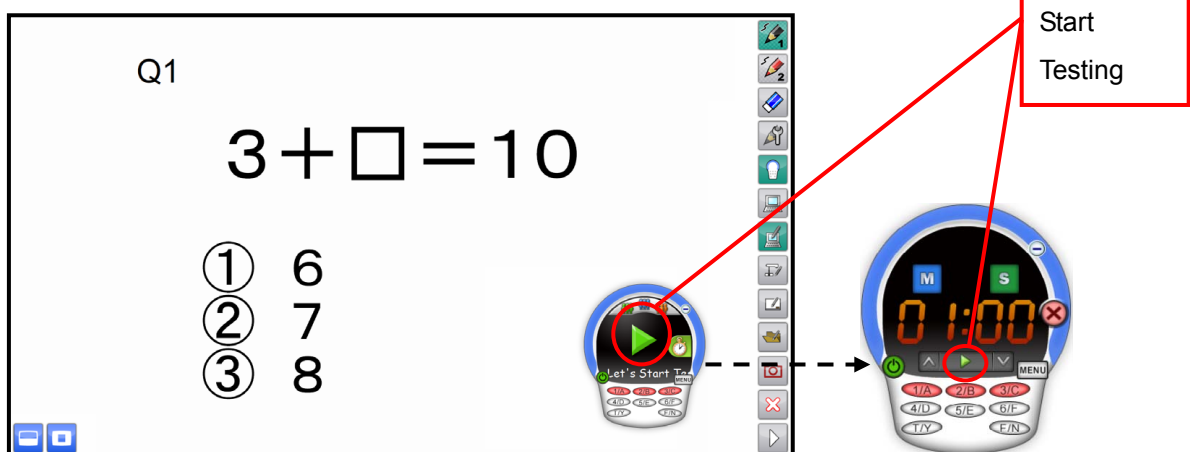

(When the Countdown Timer is used)



The question type remains the same until SRS is finished. The setting becomes the default of the question when starting SRS can be changed from **〈Image Mate Accent for SRS Configurations〉** .

3 Respond to the question by using the Response buttons on the clicker.

Respond to the question by pressing the Response buttons on the clicker. Selected button flashes for max.7 seconds when sending a response and lights up for 5 seconds if the response is successfully accepted.



Caution

If flashing Response button LED goes off in less than 12 seconds, the response is not accepted. Retry by pressing the Response button again after the LED is off. If a button that is not in the options is pressed, such response is not included in the number of responses.



Note

As long as the Testing is open, students can resubmit their responses by pressing the Response button again after the LED is off.

When the battery level is low, the power LED flashes for 5 seconds. In that case, replace the batteries with new ones.

Press one of these buttons to answer.

Q1
 $3 + \square = 10$
① 6
② 7
③ 8

low Testing

Iconize button

The number of clickers responded. By selecting this button, unanswered clickers can be displayed.

The remaining time (sec.) is displayed.

(When the Countdown Timer is used)

The diagram illustrates the clicker's interface. On the left, a question Q1 is displayed: $3 + \square = 10$ with three multiple-choice options: ① 6, ② 7, and ③ 8. A small clicker icon is shown next to the question. In the center, a larger clicker is shown with the text 'low Testing' on its screen. A red box highlights the 'Iconize' button (top left) and the 'Response' button (center). A red box on the right explains that the 'Response' button displays the number of clickers that responded and allows for displaying unanswered clickers. Another red box highlights the 'Countdown Timer' button (top right) and explains that it displays the remaining time in seconds. A green box highlights the 'Countdown Timer' button and explains that it displays the remaining time in seconds. A red box at the bottom right explains that selecting the 'Iconize' button returns the icon to the SRS control panel.

The SRS control panel can be iconized with the Iconize button. Click the icon to return to the SRS control panel. By using the Countdown Timer, you can show the remaining time.



(When iconized)

By selecting this button, the icon returns to the SRS control panel.



Note

To use the Countdown Timer, display the Countdown Timer before starting Testing and start Testing from the Countdown Timer screen.

The set time can be changed while the Countdown Timer is in operation.

Check the number of clickers responded.

When the Number of responses is selected, the Unanswered Clickers screen is displayed to check the clickers that did not respond to the question.

Also, you can configure the “Answer in place of the student” or “Absent” settings.

Unanswered clickers display.
When the student answered or you answered in place of the student, the relevant clicker number is removed from the list.

Clear unanswered clickers display

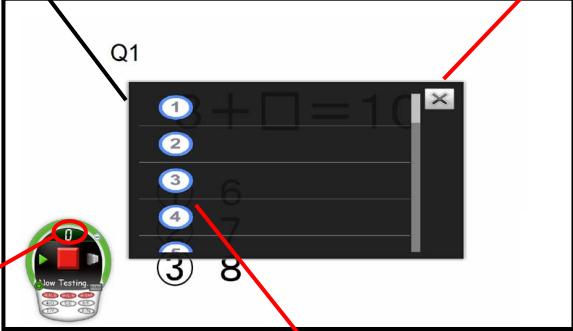

The number of unanswered clickers is displayed (or cleared).

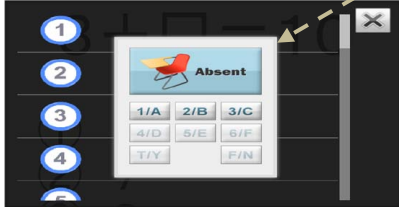

The clicker number (Student number) and the nickname (if registered) are displayed.
When this is selected, the Response Operation Window is displayed.





(When “Absent” is registered)

■ Response Operation Window

Menu button	Name	Function
	Absent button	Register/delete as an absentee. The “Absent” mark appears next to the clicker number when registered. <div style="border: 1px dashed gray; padding: 5px; display: inline-block;"> Note </div> The Response buttons are deactivated when the clicker with the “Absent” mark is selected.
	Response buttons	You can answer the question in place of the student by selecting the number. <div style="border: 1px dashed gray; padding: 5px; display: inline-block;"> Note </div> When you answer the question in place of the student, the relevant clicker number is removed from the list. You cannot modify the answer once you did it.

4 Close Testing.

Close Testing with the Close Testing button .
The color of the SRS control panel changes to blue.

 **Note**

You can annotate on the screen using annotation functions after Testing is closed.

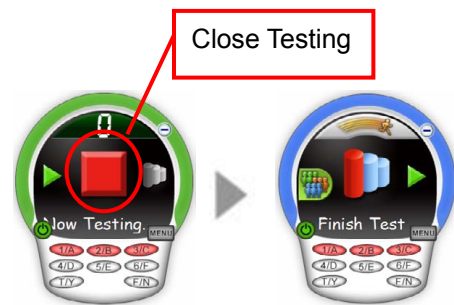

5 Display the results.

The overall results can be displayed in graph with the Display Graph button . Answer options and the number of responses are displayed.
Show a correct answer by pressing the Response button. The color of the selected button changes to green and the percentage of correct answers (Accuracy) is displayed.

The number of responses is displayed.

Accuracy

Shrink Window button

The number of students answered correctly is displayed.

Close button

Displays the Speed Ranking.

Student information display button

Switches the screen between the question screen and the results screen.

Bar graph display button

Displays the Group results.

Pie chart display button

Results display button

Selects the correct answer. The selected answer turns to green. Select the correct answer again to release it.

The number of responses for each option is displayed.

When selected, numbers of the responded clickers are displayed.

 **Note**

Each time the Results display button is pressed, the screen switches between the question screen and the results screen. When the group setting is set, the results by group can be displayed. See **<Group learning>** .

■ Windowmize the results

When the Windowmize button is selected, the results are displayed as a window at the bottom left corner over the question screen.

The results window can be moved freely by dragging it.

When the Full-screen button is selected, the results are displayed in full screen.

Press the Close button to close the results display.

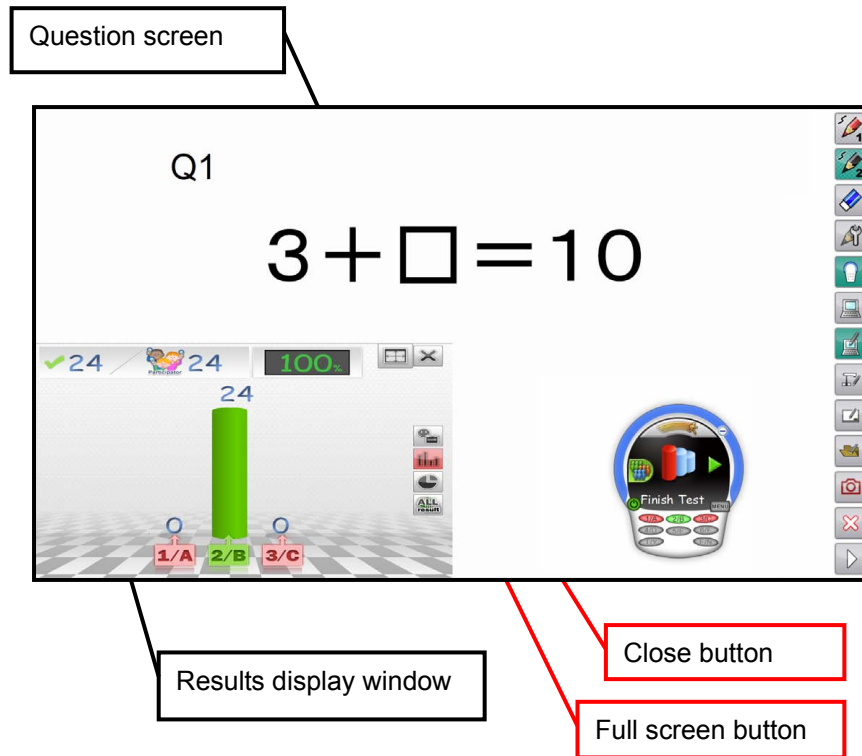

■ Speed Ranking

The screenshot shows the 'Speed Ranking' interface. It features a list of student results with blue bars representing response times. The results shown are: 6.47 sec, 6.51 sec, 7.34 sec, 10.07 sec, and 10.10 sec. The interface includes a control panel on the right with buttons for 'Top 5', 'ALL', 'Correct', and 'ALL reveal'. A 'Finish Test' button is also visible at the bottom right of the main display area.

The callout boxes provide the following information:

- The clicker number (student number) and the nickname (if registered) are displayed.
- Response time is displayed.
- The clicker number (student number) and the nickname (if registered) are displayed.
- Switches between the clicker number display and the nickname display.
- Select the number of students to be displayed at a time (Top 5/ 10/ 15/ 20). The drawing shows an example when Top 5 is selected. A scroll bar appears when all information cannot be displayed at a time.
- Switches the display range between "All" and "Only correct answers". The drawing shows an example when "All" is selected.
- The correct answers are displayed in green and the wrong answers are in red. (only when "All" is selected)

Caution Response time varies depending on the wireless condition between the clicker and the wireless adapter.

⑥ Finish the question.

You can pose next question by pressing the Start Testing button ►. The SRS control panel returns to the default status.



The results and the screen (including the drawing) are automatically saved.

Finishing SRS

1 Turn off the clicker.

When Power button  of the clicker is pressed for 3 seconds or longer, the clicker is powered off and the power LED goes off.



The clicker automatically enters standby status when there is no wireless communication.

(Pressing any button will resume the operation.)

After a certain period of time has elapsed in standby status, the power automatically goes off.

The time to power off can be changed with **<Image Mate Accent for SRS Configurations>** .

Default setting is 300 seconds.

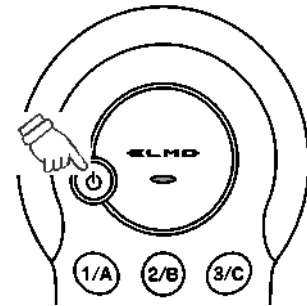

2 Clear the SRS control panel.

Clear the SRS control panel by selecting the SRS icon  .



Both the SRS control panel and the launcher are closed at the same time when the Close button  in the IMA menu icon is selected.

Group learning

You can show the results by groups by grouping clickers during a session.

1 Configure group settings.

Select the Group setting button  to display the Group setting window.

Configure group number and group type. You can also change respective group name (group symbol).



Set the Group number and the Group symbol.

Select the Group symbol setting button and select either [Default] (alphabet) or [Animals] (animals) from the pull-down menu.

Drag & drop the symbol to the Group box. (The color of the symbol changes.)

(The drawing shows an example when [Animals] is selected.)



Select the Group number setting button. Then select the number of groups from the pull down menu.



It is not possible to configure group settings during Testing.

2 Join in a group.

Join in a group by pressing one of the Response buttons on the clicker.

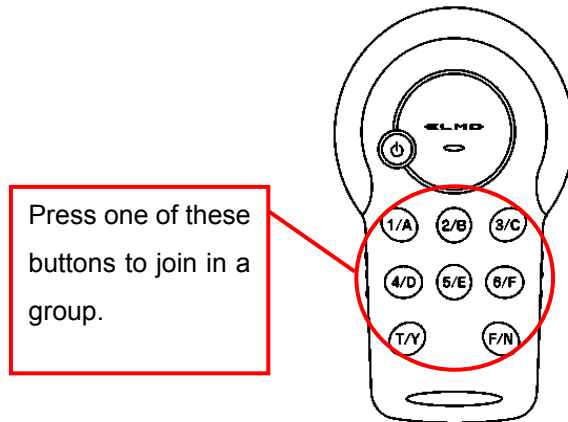

Press a button with the same number as the group you intend to join in. Your clicker number is displayed inside group box. Now you joined in the group.

The participant's clicker number (Student number) and the nickname (if registered) are displayed. The participant can be moved to other groups by drag & drop.

You can reselect the clicker that once participated in a group.

Finalize the settings.

Cancel the settings.

Clear the settings.

Finalize the settings.

Cancel the settings.

Clear the settings.

3 Finalize the group settings.

Finalize the group settings with OK button **OK** and the Setting window is closed.

4 Ask a question and display the results.

The whole process from asking a question, starting Testing, closing Testing to displaying the results is same as basic procedure.

Refer to ①~⑤in ■From posing a question to close the question .

5 Display the group results.

Select the Group icon displayed in the overall results display screen.

The screen switches to the Group results display screen.

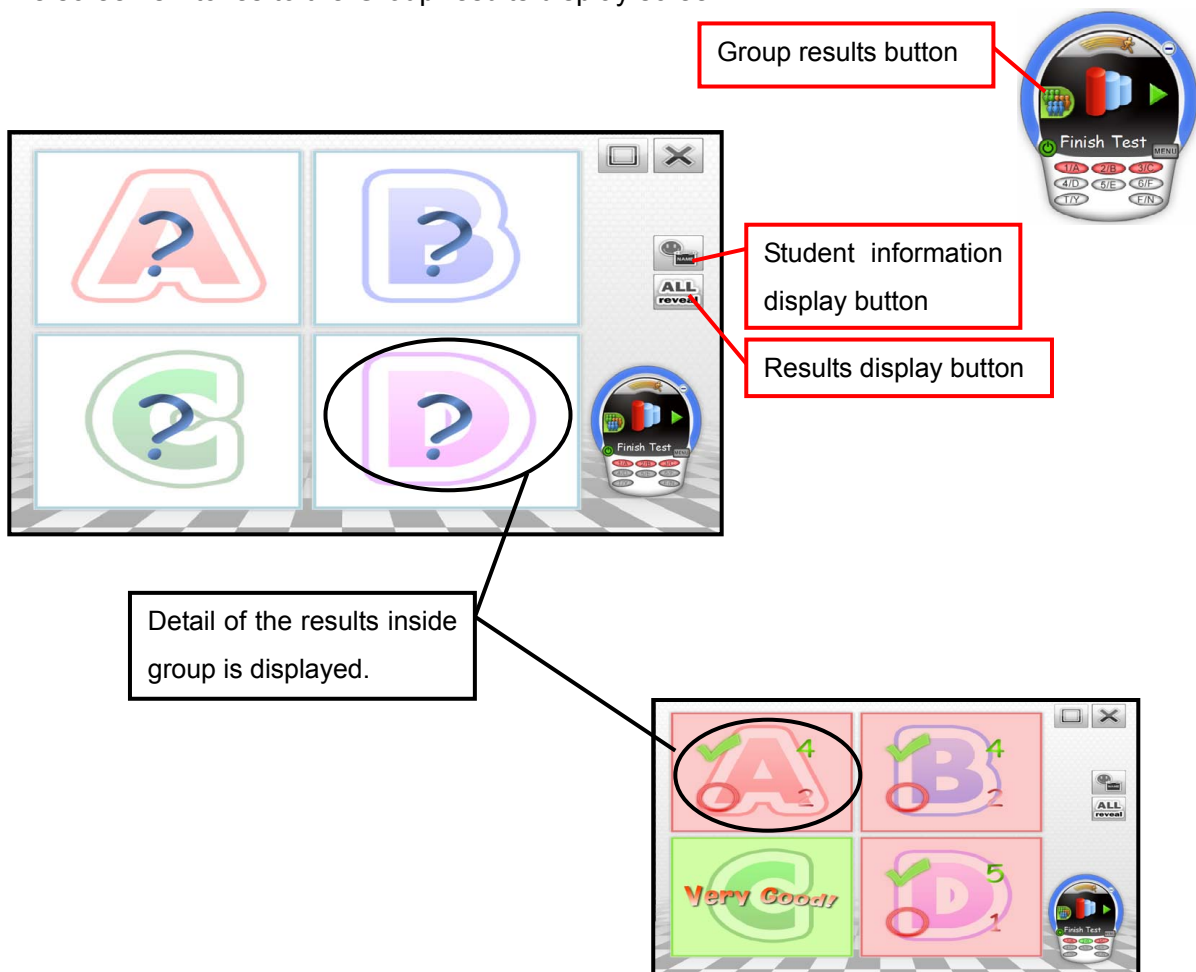

Note

Personal results can also be displayed by selecting the Results display button.

Review of the session

You can review the questions posed during the session.

1 Prepare the review.

Select the Review button  from the settings menu to change the SRS control panel to review mode.



2 Display the question screen.

Select a question in the session by using the Move button to display the question screen.

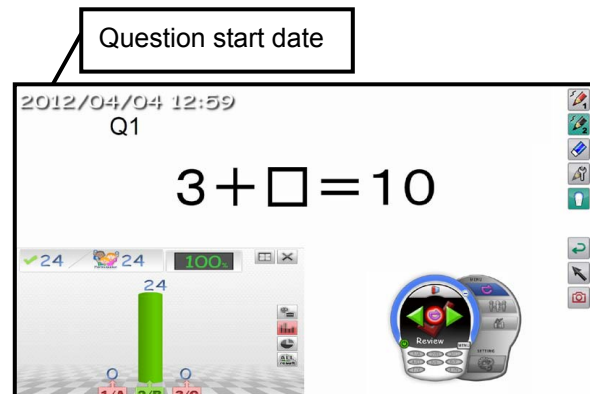
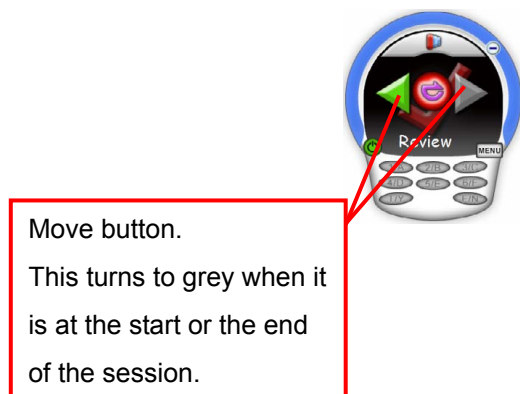

(Recorded question screen)

3 Finish the review.

Select the Review button  from the settings menu to finish the review. The SRS control panel returns to Starting screen.



The review can also be finished by selecting the review icon in the SRS control panel.

Giving an award

In each session, you can select one student to give an award. The Award screen can be saved.

1 Enter names of recipient and sender.

Select the Award button  to display the Award screen.

Enter names of recipient and sender by using the drawing function.

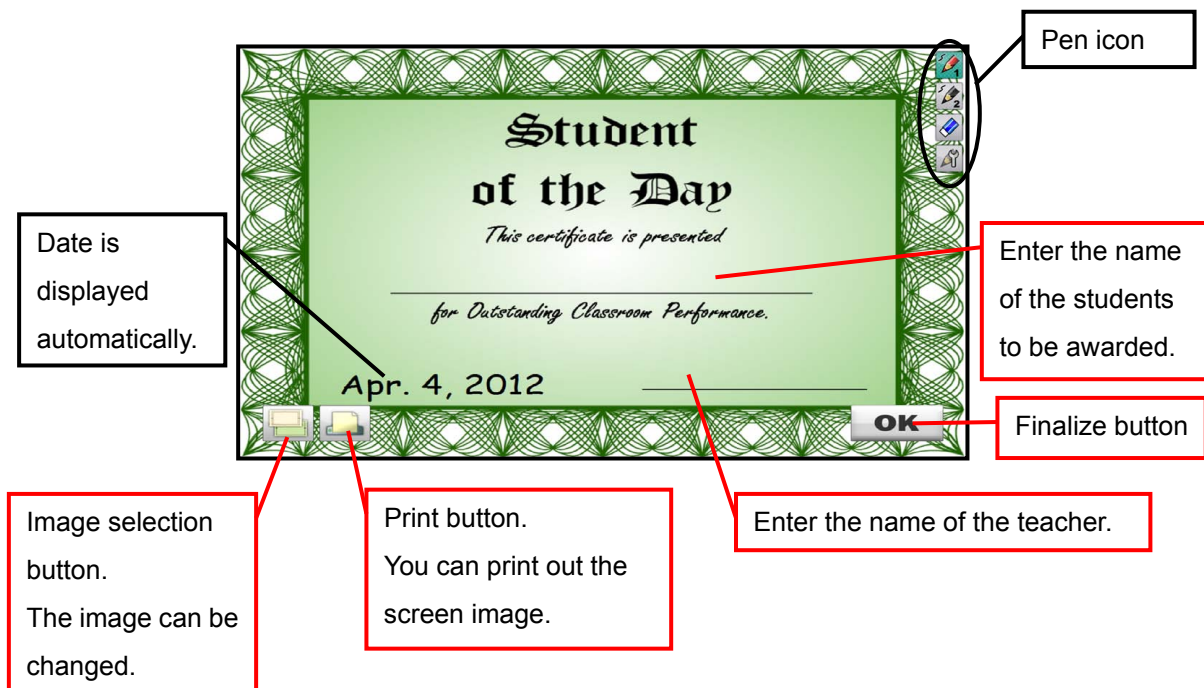



Utilizing the collected data

With ELMO SRS Reporting, the collected data that is saved on your computer can be displayed or converted into a format readable on other computers.

Using Result Display Software

Starting the software

Select a report  from the menu  in the SRS control panel to launch SRS Reporting. Then select [Test report] tab.

Select the type of report (Session Report / Personal Report) from the tabs.



The software can also be launched from [Start]-[Program Files]-[ELMO]-[Image Mate Accent for SRS]-[ELMO SRS Reporting].

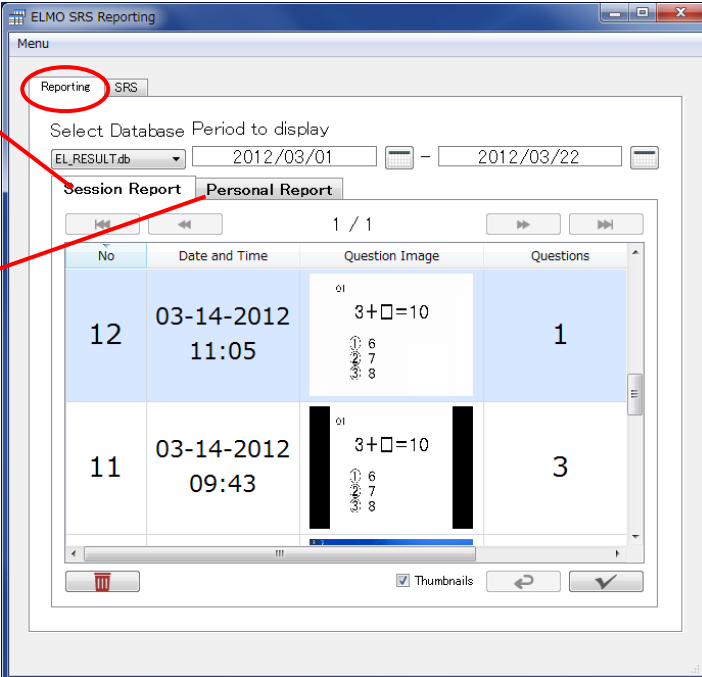

Session Report tab

Personal Report tab

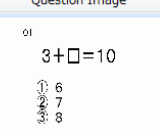
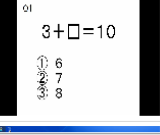
No	Date and Time	Question Image	Questions
12	03-14-2012 11:05		1
11	03-14-2012 09:43		3

Displaying the Session report

The entire process from starting Image Mate Accent for SRS to finishing is called a “session”. A list of questions in a session and details of the results of each question can be viewed.

1 Display a list of sessions.

A list of saved sessions is displayed after the [Session Report] tab is selected. The sessions displayed in the list first are the latest saved session and other sessions saved in the same month as the latest saved session. Specify the period using the calendar buttons to set the display range manually.

Items to be displayed in the list of sessions :

(Date and Time / Question Image (1st Question) / Questions)

Scroll Page button
(15 items are displayed in each page.)

Calendar button

Under selection (blue)

Delete button

Session start date
(Image Mate Accent for SRS start date)

Question thumbnail
Uncheck “Thumbnails” to hide this screen.

Select button

Number of questions

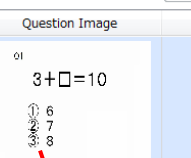
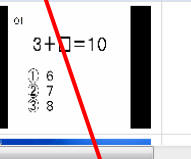
No	Date and Time	Question Image	Questions
12	03-14-2012 11:05		1
11	03-14-2012 09:43		3

2 Display a list of questions.

Select a session in the session list that you wish to view. The selected session turns blue. Press the Select button to display a list of questions in the session.

Items to be displayed in the list of questions :

(Date and Time/Question Image/Number of Students/Accuracy/Number of choices/Number of responses per choice)

The screenshot shows the ELMO SRS Reporting interface. At the top, there are fields for 'Select Database' (EL_RESULTdb) and 'Period to display' (2012/03/01 to 2012/03/22). Below this is a 'Session Report' section with a 'Personal Report' tab. A table displays the following data for a single question:

Question Number	Date and Time	Question Image	Number of Students	Accuracy	Number of choices	1/A	2/B	3/C	4/D	5/E	6/F	T/Y	F/N
1	03-14-2012 11:57		24	100%	3	0	24	0	0	0	0	0	0

Callouts in the image identify the following elements:

- Accuracy
- Number of Students
- Question Image
- Question start date (Testing start date)
- Number of choices
- Number of responses per choice
- Cells of correct answers are colored and checked.

Note

The results of multiple sessions (or questions) cannot be viewed together.
Multiple sessions (or questions) can be deleted together.

3 Draw over the question screen.

You can draw over the question screen by double-clicking a question image.

8 different pens(Black, Red, Green, Blue, Cyan, Magenta, Yellow, White) are available.

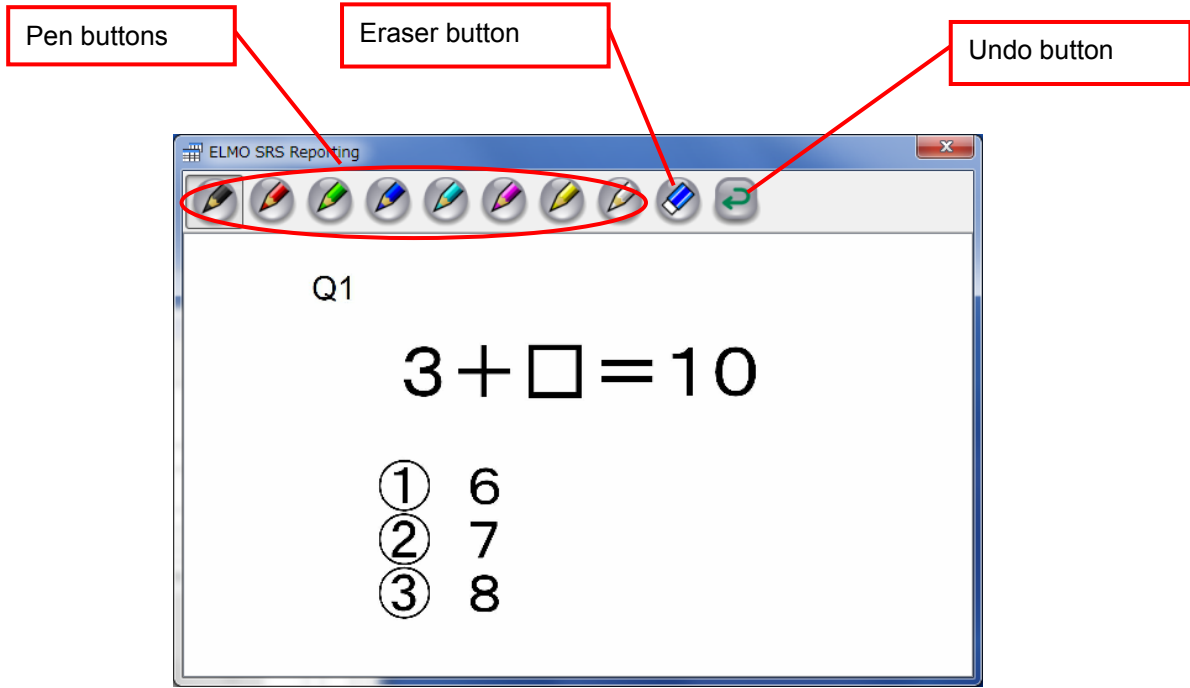

Note

The software asks whether to save the annotations once the close button is pressed. If you select "save", a dialogue "Save as" appears to save the image.

4 Display a report for the question.

Select a question in the question list that you wish to view. The selected question turns to blue.

Press the Select button to display a report for the question.

5 Print a report.

Contents of a report can be printed.

Select [PRINT] button while a report is displayed.



The printer needs to be installed on your computer.

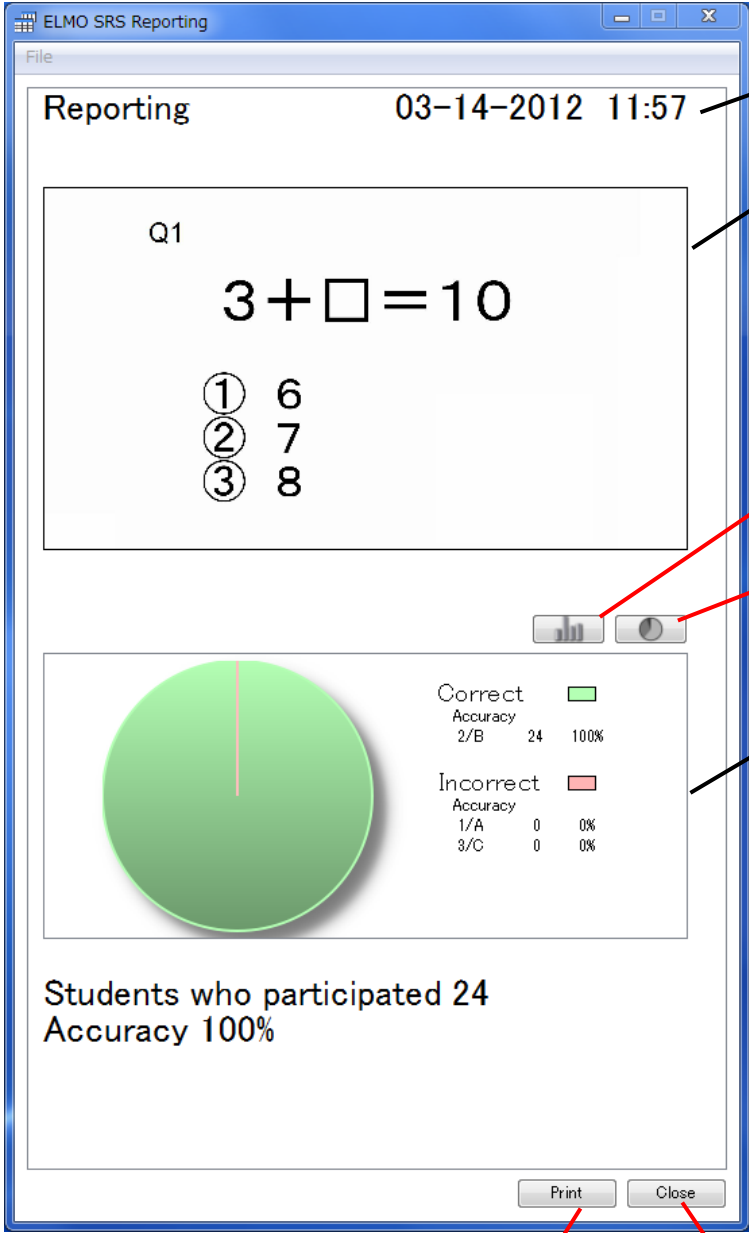

The screenshot shows the ELMO SRS Reporting window. At the top right, the date and time are displayed as 03-14-2012 11:57. The main content area shows a question screen for 'Q1' with the equation $3 + \square = 10$ and three multiple-choice options: ① 6, ② 7, and ③ 8. Below the question is a pie chart representing the results. To the right of the pie chart is a table showing the accuracy for correct and incorrect answers.

Category	Accuracy	Count	Percentage
Correct	2/B	24	100%
Incorrect	1/A	0	0%
Incorrect	3/C	0	0%

Students who participated 24
Accuracy 100%

At the bottom of the window are 'Print' and 'Close' buttons. On the right side of the window, there are two buttons: a 'Bar graph button' and a 'Pie chart button'.

Labels in the image:

- Date - Time
- Question screen (Saved screen with added annotations are displayed.)
- Bar graph button
- Pie chart button
- Results graph
- Print button
- Close button

Output the personal report

Review the personal results from the saved record.

1 Display the list of sessions.

Select the [Personal Report] tab to display the list of sessions.

The sessions displayed in the list first are the latest saved session and other sessions saved in the same month as the latest saved session. Specify the period using the calendar buttons to set the display range manually.

Items to be displayed in the list of sessions :

(Date and Time / Question Image (1st Question) / Number of questions)

Items to be displayed in the list of questions :

(Student number / Answers per questions / Percentage of students answered correctly)

The screenshot shows the 'ELMO SRS Reporting' application window. At the top, there is a 'Menu' bar with 'Reporting' and 'SRS' tabs. Below this, a 'Select Database' dropdown is set to 'EL_RESULTdb'. The 'Period to display' is set from '2012/03/01' to '2012/03/14', with 'Calendar button' callouts pointing to the date selection fields. The interface is split into two main sections: 'Session Report' and 'Personal Report'. The 'Session Report' table lists sessions with columns for 'Date' and 'Questions'. The selected session is '2012/03/14 11:05' with 1 question. A callout 'Session start date' points to the date field. The 'Personal Report' section shows a 'Results' table with columns for 'Questions', 'Answers', and 'Ratio'. The 'Answers' column shows '2/B' for all six questions, with '2' highlighted in green. A callout 'Question number' points to the 'Questions' column, and another callout 'Percentage of students answered correctly' points to the 'Ratio' column. A callout 'Answers. Correct answer is displayed in green.' points to the green '2' in the 'Answers' column. A callout 'Student number' points to the '01' student ID. A callout 'Question Image. You can edit the contents by double clicking it.' points to a question image showing a math problem: $3 + \square = 10$ with multiple choice options ① 6, ② 7, and ③ 8.

Session Date	Questions
2012/03/14 17:58	1
13:56	7
12:19	1
11:05	1

Questions	Answers	Ratio
1	2/B	100%
2	2/B	100%
3	2/B	100%
4	2/B	100%
5	2/B	100%
6	2/B	100%

01
 $3 + \square = 10$
① 6
② 7
③ 8

Saving in other formats

The collected results can be saved by session in csv/ xml/ xel and xls formats.

Select [Export] from [Menu] while a list of sessions (or questions) are displayed.

Select [Export] after specifying a date, save format and a destination folder from the dialogue displayed.

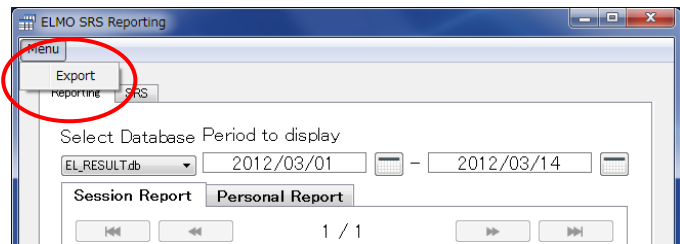

Tick here to save all the records.

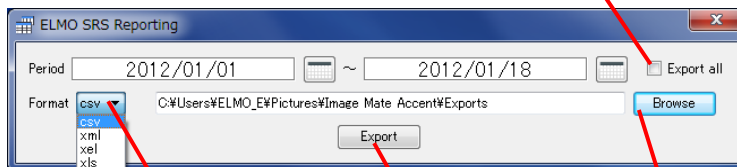

Specify a destination folder.

Export button

Select a save format.



A folder in which image files for the question screen are saved is created in the same folder as the export file when the results are exported in XML format.

Various Settings

In this section, you will learn how to configure SRS.

Wireless setting for the clicker

If the wireless connection cannot be established after pressing Response buttons (the "Response button LED" continues to flash) perform the wireless setting using the "Wireless setting button" inside the battery box and on the wireless adapter.



Caution

- Perform the wireless setting within 30 seconds of pressing the "Wireless setting button" inside the battery box.
- Hold the body of the wireless adapter when pressing the "Wireless setting button" on the wireless adapter.

Turn on the power of the clicker.



Press the "Wireless setting button" inside the battery box.



[2/B] button flashes at high speed.



Press the "Wireless setting button" on the wireless adapter.



[1/A] button and [3/C] button on the clicker flashes a few times. Now wireless connection between the clicker and the wireless adapter is established.

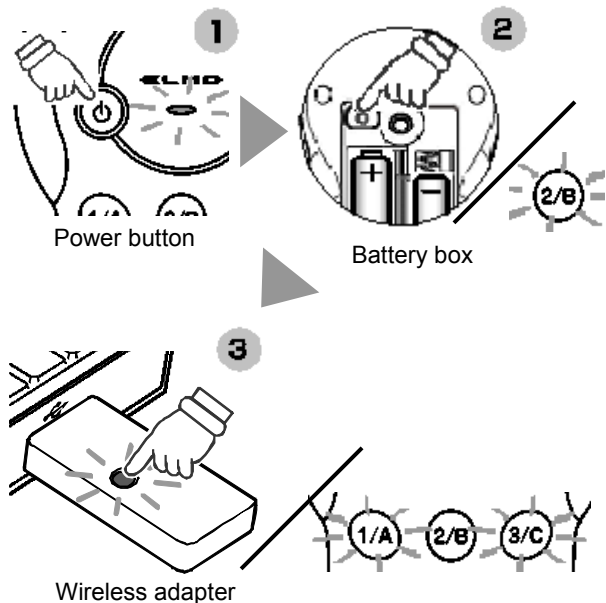

Note

The wireless setting between the clicker and the wireless adapter was established prior to shipping. When adding a clicker, the wireless setting for the added clicker needs to be performed before use.



Caution

If a clicker is used as described below, wireless connection with the wireless adapter may become unstable:

- There is an obstruction between the clicker and the wireless adapter.
- The clicker is used while placed on top of a computer.
- A wireless device or electronic equipment is being used nearby.
- The clicker is moved excessively while being used.
- Clickers are used too close with each other.
- Hold the clicker with your hand covering the upper part of it.

Also, due to the inherent characteristics of the wireless connection, the wireless connection may become unstable in some positional relationships between the clicker and the wireless adapter.

Image Mate Accent for SRS Configurations

With ELMO SRS Configurations, Image Mate Accent for SRS can be configured.

Starting the software

Select “Configurations”  from “Menu”  in the SRS control panel.



ELMO SRS Configurations can also be launched from [Start]-[Program Files]-[ELMO]-[Image Mate Accent for SRS]-[ELMO SRS Configurations].

Description of menu tabs

Items to be configured or checked in each sheet are as follows:

[Settings] : Contents location

[SRS Settings] : Database Location / Timer settings / Default quiz type / Automatically display graph results / Clicker Power

[Software update] : Image Mate Accent for SRS / Proxy setting

[About] : Software information

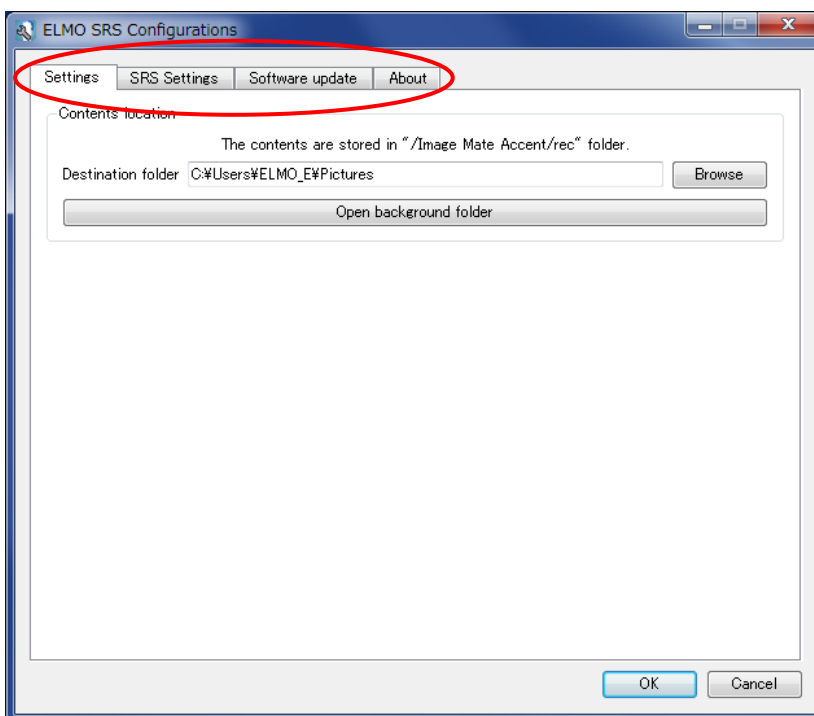

Settings

The destination to store the data created by Image Mate Accent for SRS can be set.

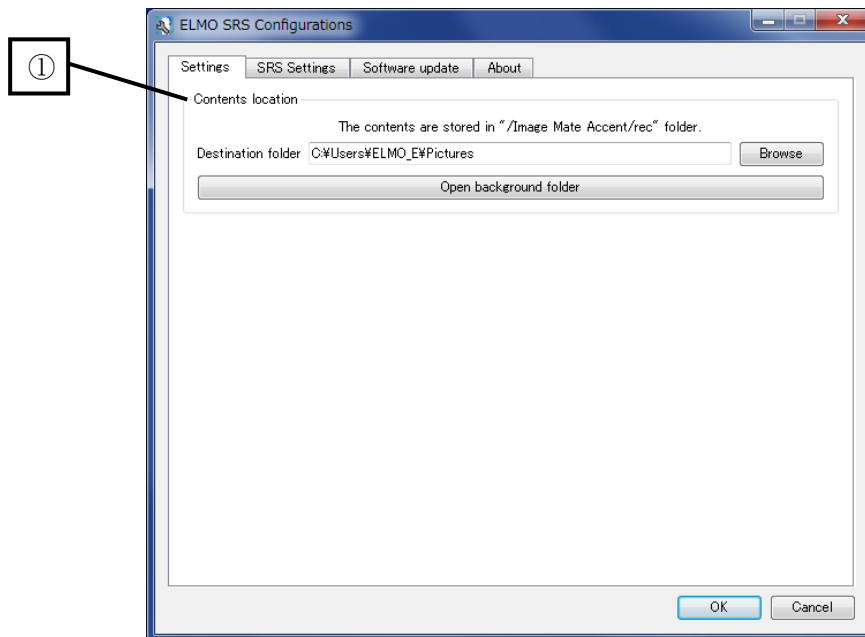

① Contents location

The destination to store the contents created by Image Mate Accent for SRS and the folder to add stamps and background images can be set.

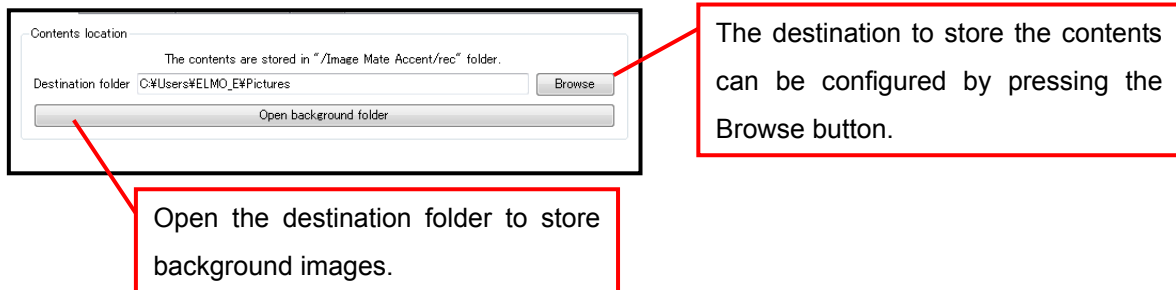

Note

The contents are stored in “Image Mate Accent” folder created inside the specified “destination folder”.



Image files can be added as stamps or backgrounds in jpg, bmp or png formats.

(Note that it may not be able to display some files in these formats.)

The existing data inside the folder is not automatically transferred to a new destination folder when the destination folder is changed.

The previous data cannot be displayed after making this change.

SRS Settings

Image Mate Accent for SRS can be configured from “SRS Settings”.

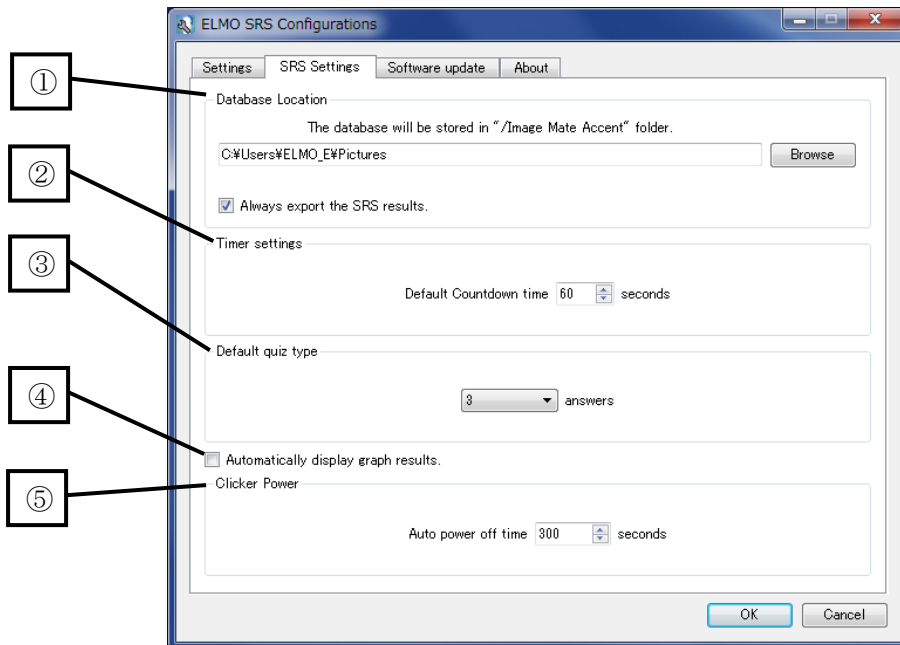

① Database Location

The destination to store the database used by Image Mate Accent for SRS and the records of SRS can be set.



The destination to store the SRS records can be configured by pressing the Browse button.

Tick here to automatically output the SRS data after the session. The SRS data can be imported by iRespond (sold separately).



The previous results cannot be displayed after making this change.



The contents are stored in “Image Mate Accent” folder created inside the specified “destination folder”. For details on iRespond (sold separately), please contact a dealer.

② Timer Settings

The initial setting of the timer can be set in increments of 10 sec. between 10 sec. and 60 sec. and in increments of 60 sec. between 60 sec. and 300 sec. using up/down buttons.



Default setting of the timer is 60 sec.

③ Default quiz type

The question type when SRS is started can be set. (Default setting: 3-choice question)
Select a question type (2-6 choice, True (Yes)/ False (No)) from the pull-down menu.

④ Automatically display graph results

Put a tick mark here when you want to show the results first in the Results Display screen.

⑤ Clicker Power

The time for auto power off of the clicker can be set in increments of 10 sec. between 10 sec. and 2,550 sec. using up/down buttons.

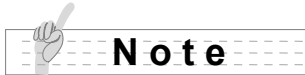

Default setting is 300 seconds.

Setting the time for auto power off longer may affect the lifetime of the batteries.

Software update

The automatic update for the software can be set.



Access our update page to verify you are running the latest version of the software. You need to have an internet connection to update your software.

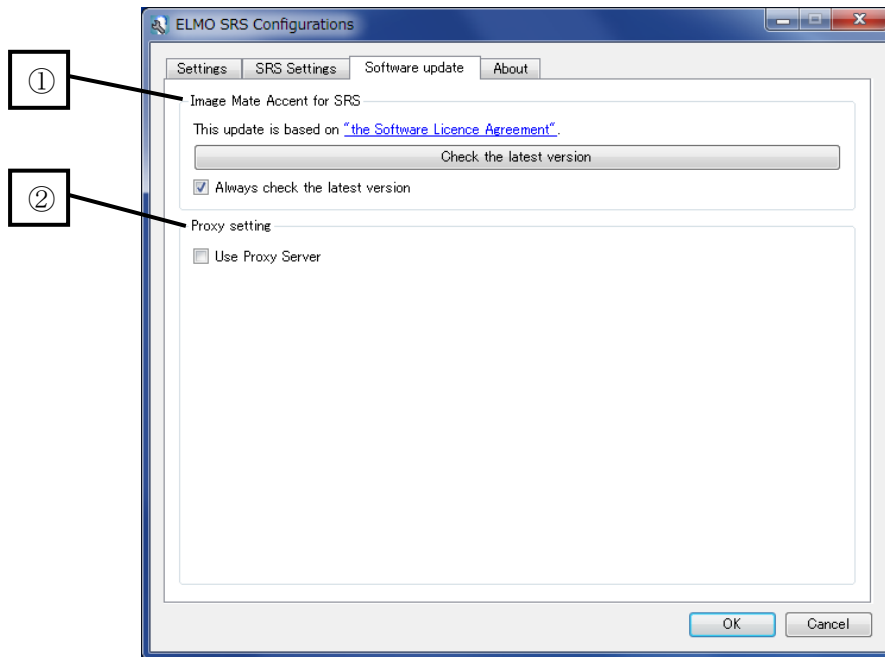

① Image Mate Accent for SRS

Press the Check the latest version button to check the availability of the update.

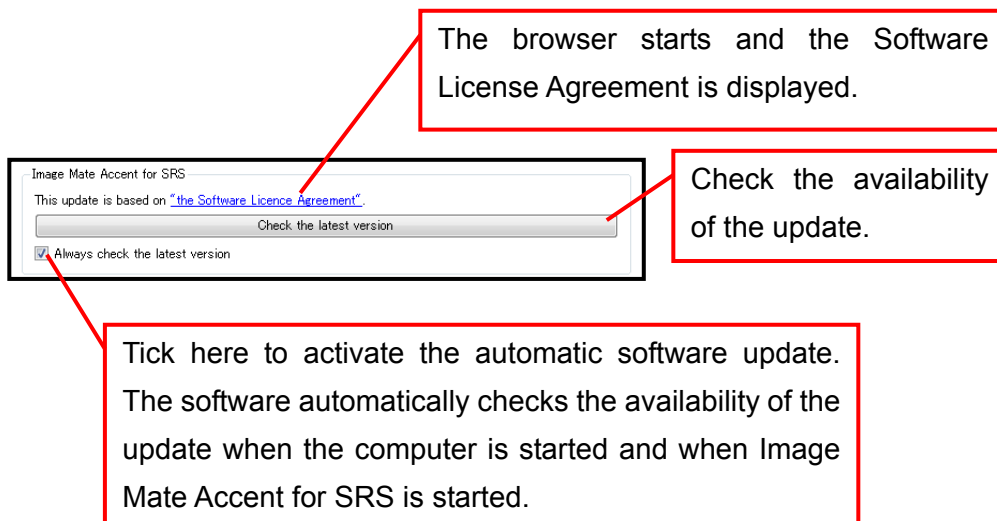

② Proxy setting

You can use the software with default settings.

When you need to configure this setting, put a tick mark in “Use Proxy Server”.



Tick here.

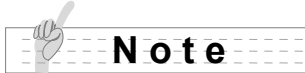

Consult your internet administrator or provider for details as to the configuration.

About

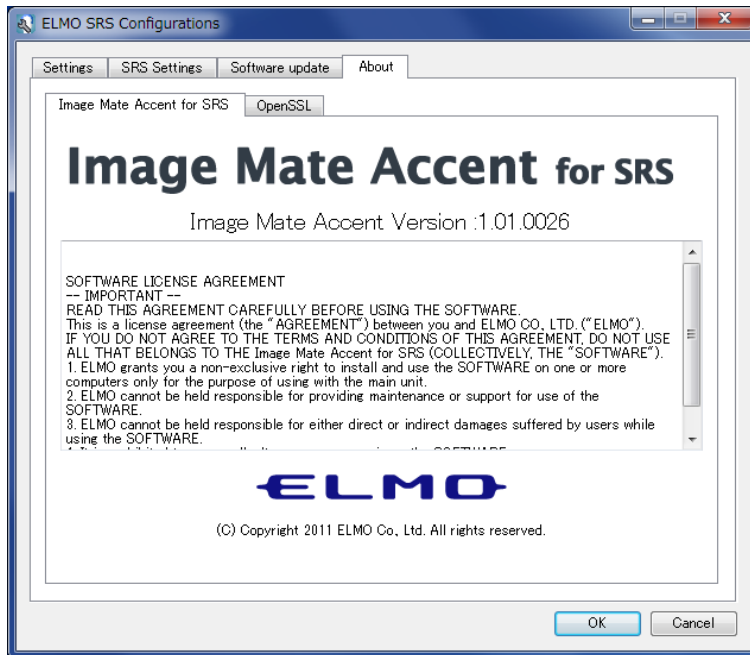

You can see the detailed information of the software.



SRS Data Settings

With ELMO SRS Reporting, you can manage the student's data and the clicker.

Starting the software

Select a report  from the menu  in the SRS control panel to start SRS Reporting. Then select the "SRS" tab.





ELMO SRS Reporting can also be launched from [Start]-[Program Files]-[ELMO]-[Image Mate Accent for SRS]-[ELMO SRS Reporting].

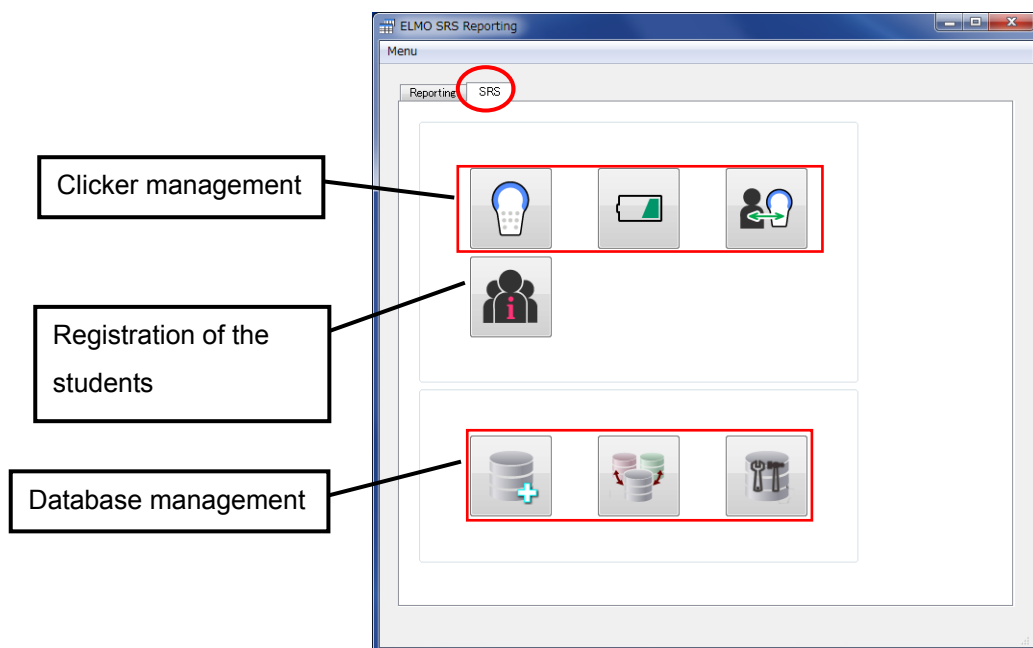

To perform the other operation than "Battery level check", close the Image Mate Accent for SRS first. Make sure that the wireless adapter is connected to your computer.





■ Clicker

Menu button	Name	Function
	Check the Connection	To check the wireless connection.
	Battery level	To display the last used time and the battery level.
	Clicker Information	To associate the clicker with a student or add/delete the clicker.

■ Register

Menu button	Name	Function
	Register students information	To register the students' information.

■ Database

Menu button	Name	Function
	Create Database	To register the database. See <Database Settings> .
	Select Database	To select the database.
	Edit Database Profile	To edit the database profile.

Check the connection

The wireless connection with the registered clicker can be checked. Press a button of the clicker that you want to check after connecting the wireless adapter to your computer. Device ID, the button that is pressed, the battery level and the clicker version are displayed.

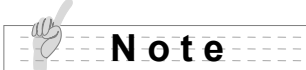

Connect the wireless adapter to your computer before performing the wireless connection check.

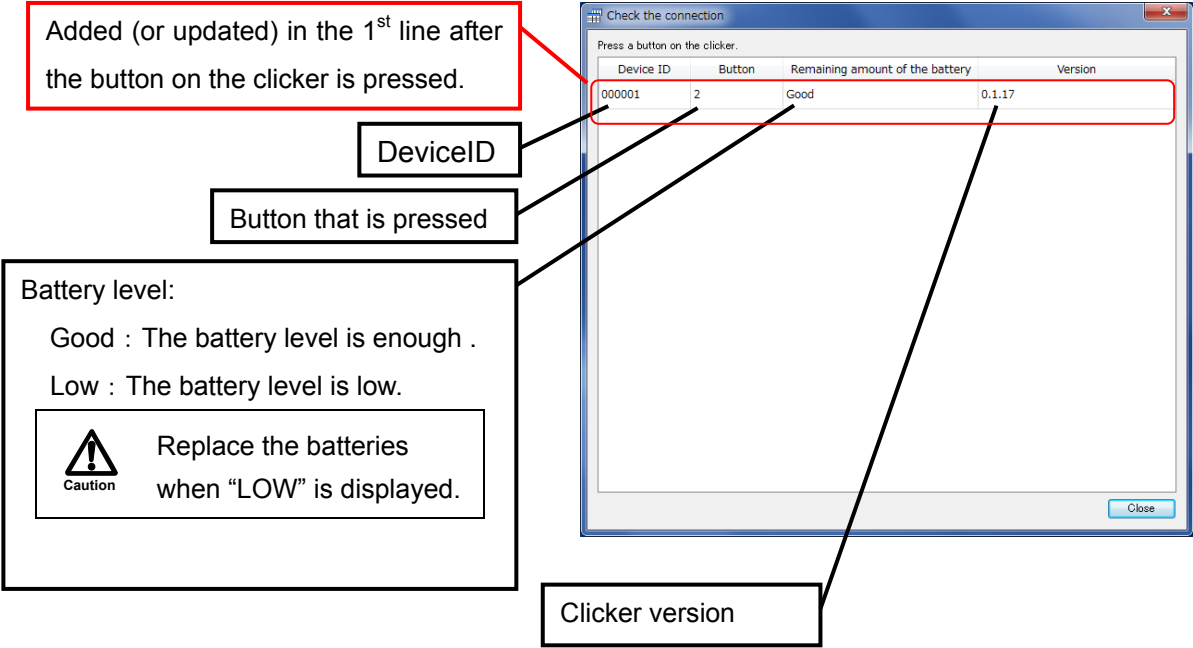

Added (or updated) in the 1st line after the button on the clicker is pressed.

Device ID	Button	Remaining amount of the battery	Version
000001	2	Good	0.1.17

DeviceID

Button that is pressed

Battery level:
Good : The battery level is enough .
Low : The battery level is low.

 Replace the batteries when "LOW" is displayed.

Clicker version

Battery level

The last used time and the battery level for all the registered clickers can be displayed.

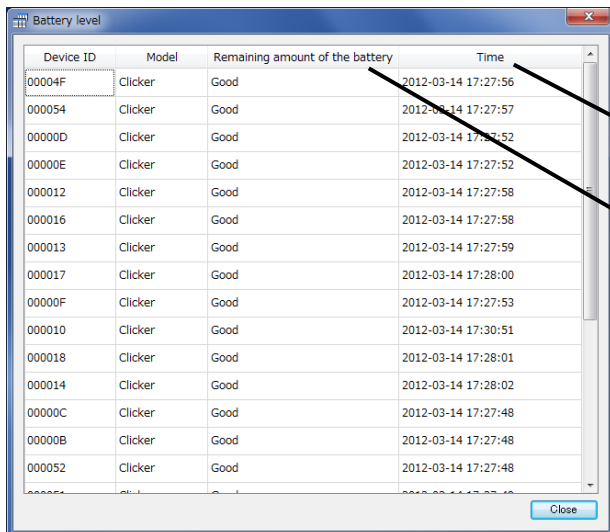

Device ID	Model	Remaining amount of the battery	Time
00004F	Clicker	Good	2012-03-14 17:27:56
000054	Clicker	Good	2012-03-14 17:27:57
00000D	Clicker	Good	2012-03-14 17:27:52
00000E	Clicker	Good	2012-03-14 17:27:52
000012	Clicker	Good	2012-03-14 17:27:58
000016	Clicker	Good	2012-03-14 17:27:58
000013	Clicker	Good	2012-03-14 17:27:59
000017	Clicker	Good	2012-03-14 17:28:00
00000F	Clicker	Good	2012-03-14 17:27:53
000010	Clicker	Good	2012-03-14 17:30:51
000018	Clicker	Good	2012-03-14 17:28:01
000014	Clicker	Good	2012-03-14 17:28:02
00000C	Clicker	Good	2012-03-14 17:27:48
00000B	Clicker	Good	2012-03-14 17:27:48
000052	Clicker	Good	2012-03-14 17:27:48

Last connected time

Battery level:
Good : The battery level is enough.
Low : The battery level is low.

 Replace the batteries when "Low" is displayed.



Perform the **<Check the connection>** to see the current battery level.

Clicker Information

When the wireless adapter is connected, the Device ID, the clicker number and the student's information (if registered) are displayed.

You can also add or change the clicker here.



Connect the wireless adapter to your computer before performing the above operation.

The row of the specific clicker ID's can be selected by pressing any buttons on the relevant clicker.

Enable	Device ID	Student Number	Picture	Nickname
<input checked="" type="checkbox"/>	000001	1		
<input checked="" type="checkbox"/>	000002	2		
<input checked="" type="checkbox"/>	000003	3		
<input checked="" type="checkbox"/>	000004	4		
<input checked="" type="checkbox"/>	000005	5		
<input checked="" type="checkbox"/>	000006	6		
<input checked="" type="checkbox"/>	000007	7		
<input checked="" type="checkbox"/>	000050	8		
<input checked="" type="checkbox"/>	000051	9		
<input checked="" type="checkbox"/>	000052	10		

Press this button to change the clicker.

Student's nicknames and pictures are displayed (if registered).

The clicker numbers (student numbers) are displayed.

Enable or disable the clicker.
Put a tick mark here to enable the clicker.



After the wireless setting for the added clicker is performed, a Device ID is newly assigned to the added clicker and it is added to the bottom of the list.

Refer to **<Adding or Changing the clicker>** for details about adding or changing the clicker.

Max. 50 clickers can be registered.

Register students information

The students' information can be registered.

 Caution	<p>Pay strict attention to the protection of the personal information and the right of publicity of the students. ELMO is not responsible for any loss or leak of the personal information of the students in relation to the use of SRS.</p>
---	---

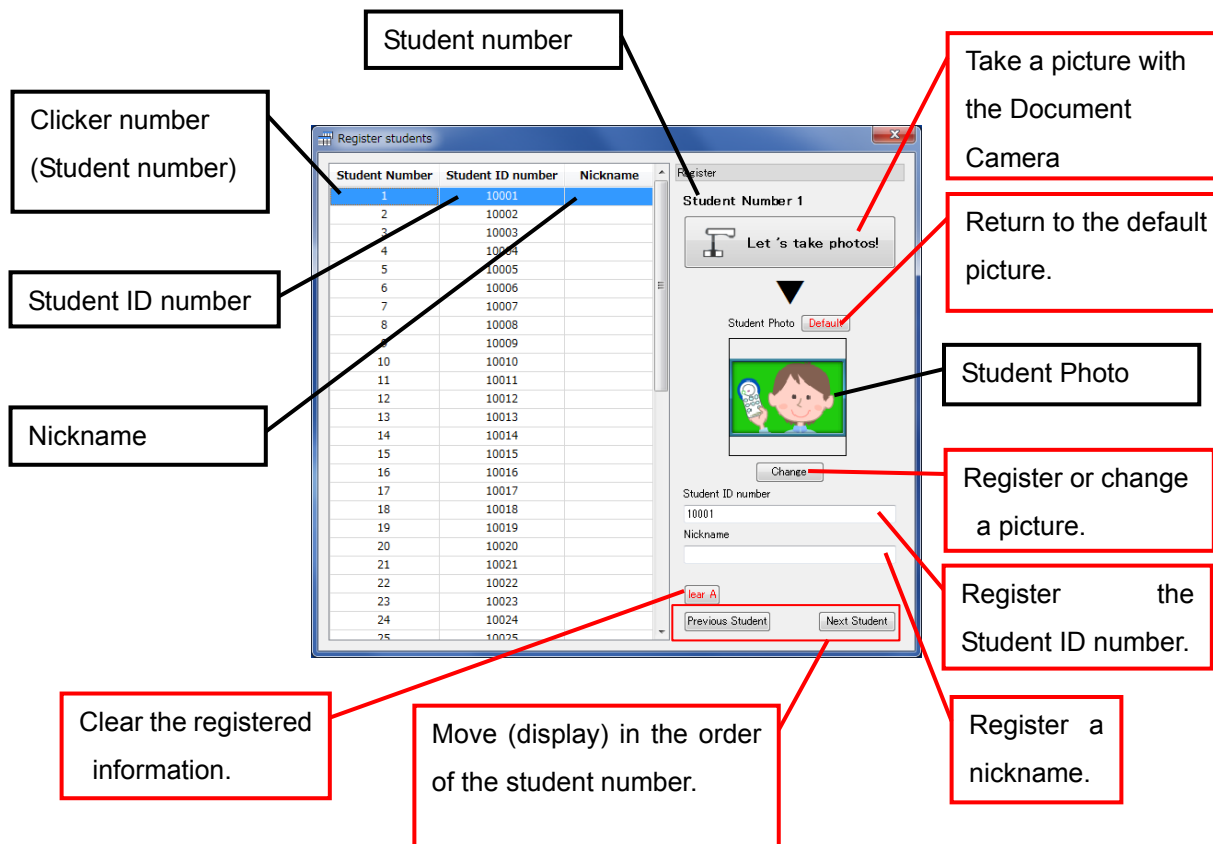

The screenshot shows a software window titled 'Register students' with a table of student data and a registration form. Callout boxes provide the following instructions:

- Clicker number (Student number)**: Points to the 'Student Number' column in the table.
- Student ID number**: Points to the 'Student ID number' column in the table.
- Nickname**: Points to the 'Nickname' column in the table.
- Student number**: Points to the 'Student Number' field in the registration form.
- Take a picture with the Document Camera**: Points to the camera icon and 'Let's take photos!' button.
- Return to the default picture.**: Points to the 'Default' button below the photo area.
- Student Photo**: Points to the photo of a child.
- Register or change a picture.**: Points to the 'Change' button.
- Register the Student ID number.**: Points to the 'Student ID number' input field.
- Register a nickname.**: Points to the 'Nickname' input field.
- Clear the registered information.**: Points to the 'Clear A' button.
- Move (display) in the order of the student number.**: Points to the 'Previous Student' and 'Next Student' buttons.

 **Note**

Same number of the students as the clickers you use can be registered.
(Max. 50 clickers can be registered.)

Let's take photos!

You can take a picture of the student for the student information by using the Document Camera.

Connect the Document Camera to your computer and switch it on.

Select the clicker number under which the picture is registered. Then press the "Let's take photos!" button to display the photo shooting window.

Press the shutter button to register the captured picture.

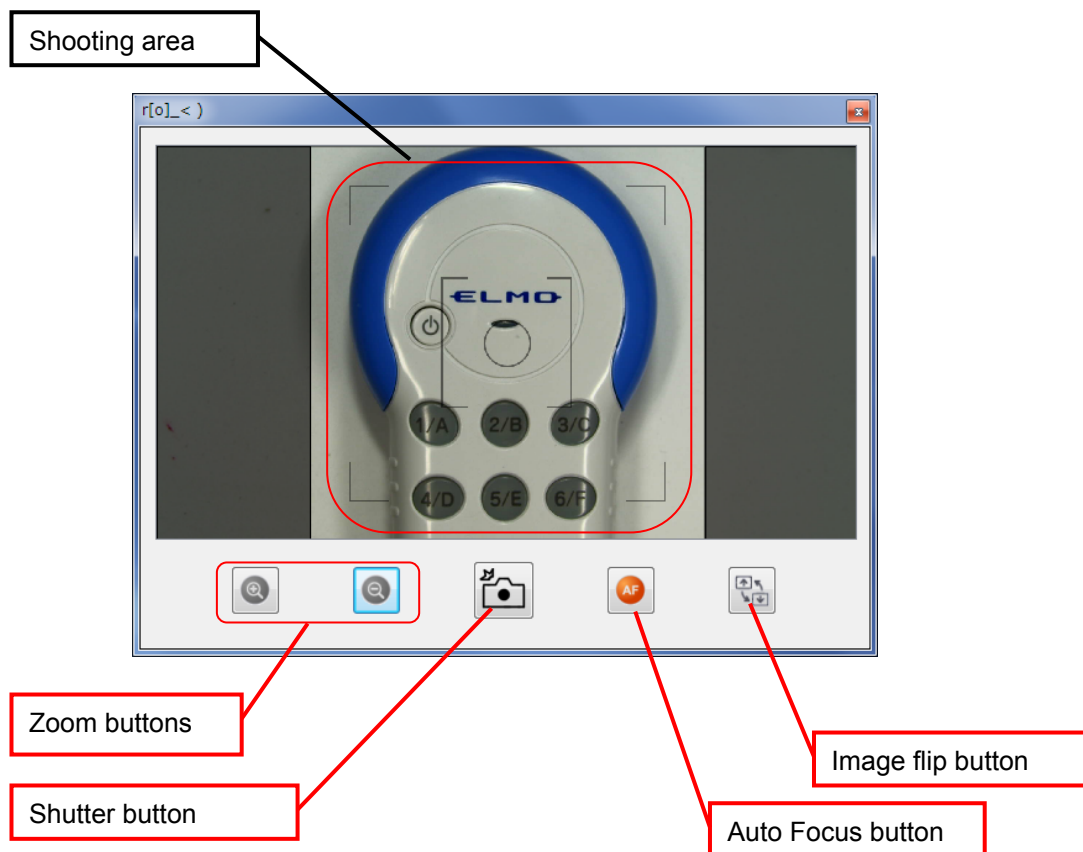

Database Settings

Create Database

When the Create Database button  is selected, a new database or a copy of the existing database is created.

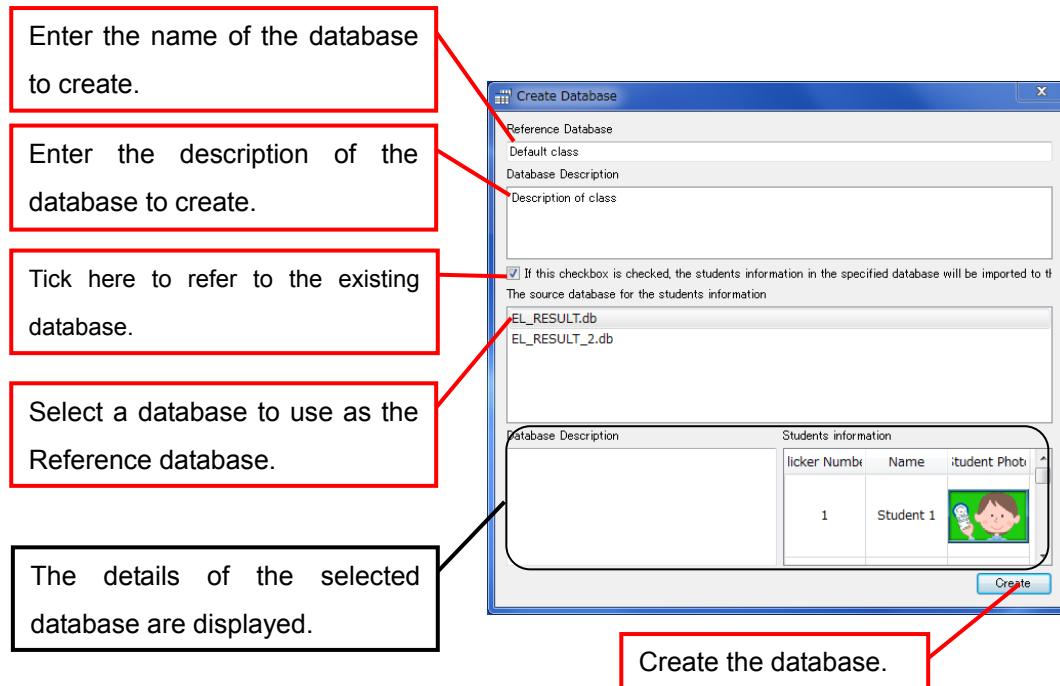

The screenshot shows the 'Create Database' dialog box with the following fields and options:

- Reference Database:** A dropdown menu with 'Default class' selected.
- Database Description:** A text area for 'Description of class'.
- Import checkbox:** A checked checkbox with the text: 'If this checkbox is checked, the students information in the specified database will be imported to this database. The source database for the students information is:'. Below it, 'EL_RESULT.db' and 'EL_RESULT_2.db' are listed.
- Database Description:** A text area for the new database's description.
- Students information:** A table showing data from the selected source database.
- Create button:** A button at the bottom right to finalize the creation.

Callout boxes provide instructions for each field:

- Enter the name of the database to create.
- Enter the description of the database to create.
- Tick here to refer to the existing database.
- Select a database to use as the Reference database.
- The details of the selected database are displayed.
- Create the database.

When creating a new database, select the “Create” button after entering the database name and the database description.

When using an existing database, select such database after activating the tick box.

The details of the selected database are displayed. Confirm if the selected database is the right one.

Then enter the name and the description of the database to create.

After completing all the procedures, select the Create button.

Note

A database cannot be created without entering the database name.

A database cannot be created if a database with the same name exists.

Select Database

When the Select Database button  is selected, the default database can be set.

The name of the current database is displayed.

The student's information of the selected database is displayed.

Select a database.

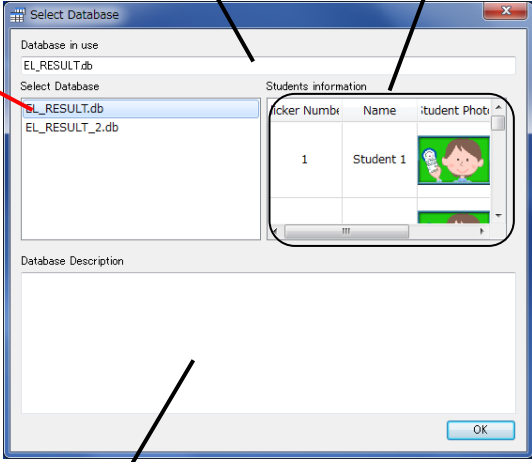

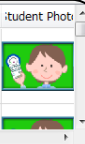
Ticker Number	Name	Student Photo
1	Student 1	

The description of the selected database is displayed.

When a database is selected, the details of the selected database are displayed. Press the [OK] button after confirming that the selected database is the right one.

Edit Database Profile

By selecting the Edit Database Profile button  , you can edit the name and the description of the registered database.

Select the database you wish to edit, then edit the name and the description.

Press the OK button after finishing the edit.

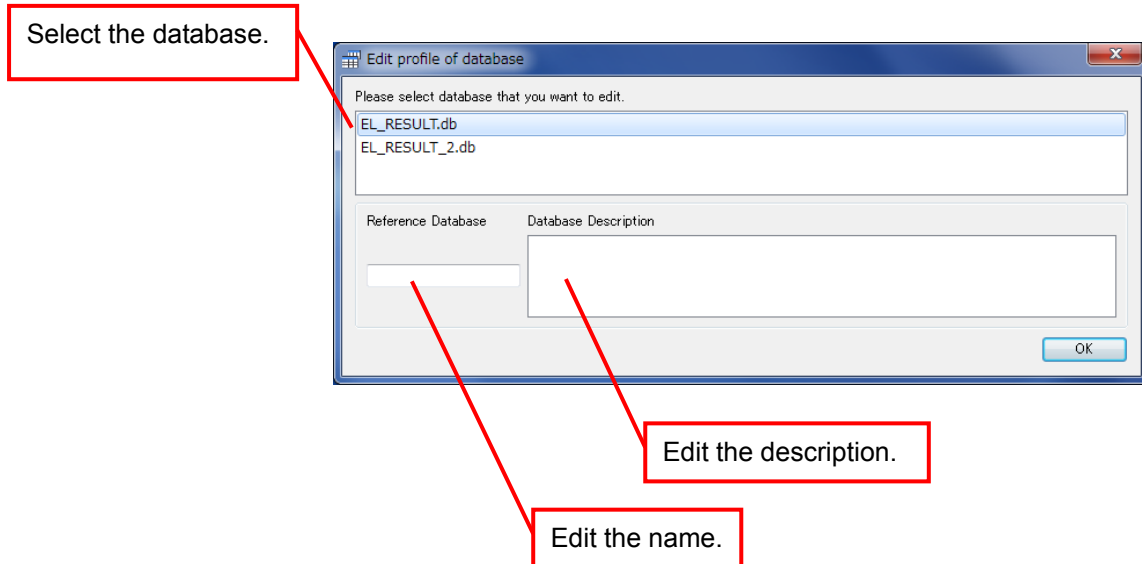

Adding or Changing the clicker

In case you need to add the clicker or replace the clicker due to reasons such as malfunction, follow the instruction described below.



Connect the wireless adapter to your computer before performing the above operation.



Make sure to follow the instruction correctly otherwise the system may not recognize the added clicker.

1 Perform the wireless setting for the added clicker.

Establish the wireless setting between the added clicker and the wireless adapter.

Refer to **〈Wireless setting for the clicker〉** in Various Settings for details

2 Launch ELMO SRS Configurations.

Launch the configuration software.

Select the Clicker Information button  in the "SRS" tab to show the list of clickers.

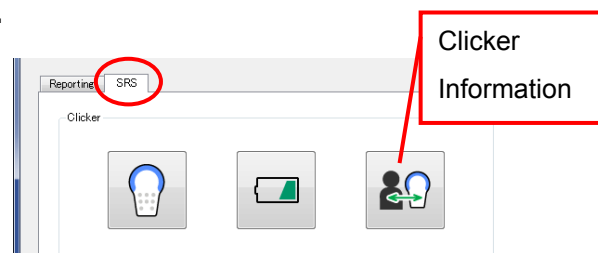

3 Select the added clicker.

Turn on the added clicker and press one of the Response buttons on the clicker. Verify that the Device ID of the added clicker is displayed in blue.

If the Device ID of the added clicker is not displayed, retry from the step ① "wireless setting".

When adding the clicker, press the OK button to finish.

Register the student, if necessary.

When changing the clicker, continue to the step ④.

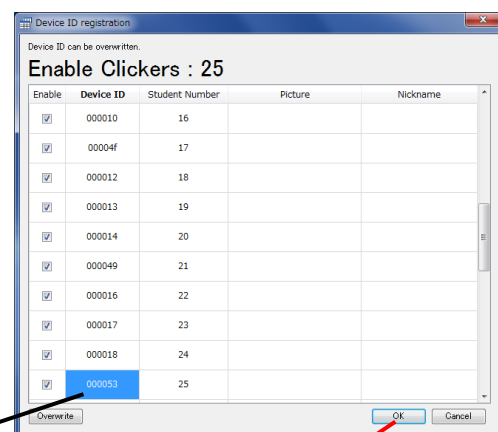

The cell turns to blue when the Response button of the clicker is pressed.

OK button



The Device ID for the added clicker can be selected by a mouse.

4 Select the clicker to be replaced.

Select the Overwrite button. The Device ID of the added clicker turns to green from blue.

Select the Device ID of the clicker to be overwritten (deleted) from the list by using a mouse. The color of the Device ID of the relevant clicker turns to grey.

Select the Device ID of the clicker to be replaced.

Overwrite button

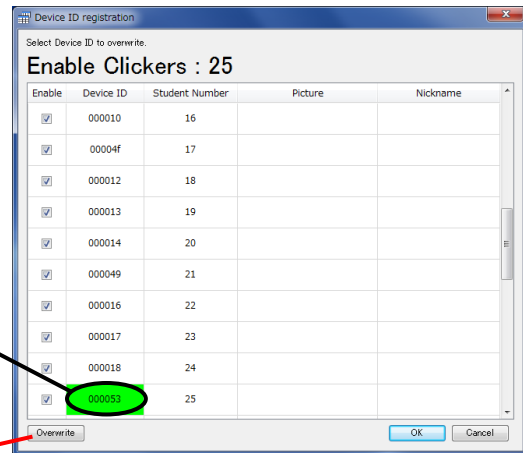

5 Overwrite the data.

Select [OK] after confirming the message in a dialogue box.

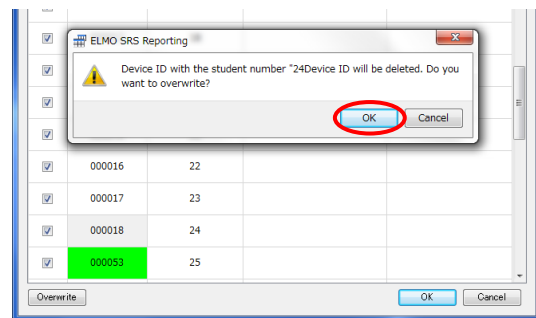

Caution

Only Device ID is overwritten. Other items remain unchanged. Once the clicker is replaced (overwritten), such clicker will not be able to communicate with the wireless adapter. Perform the **〈Wireless setting for the clicker〉** to use the clicker again.

6 Finalize the registration.

Finalize the registration by pressing [OK].



Caution

Make sure to select the OK button to activate the change.

Other Function

About LED



The power LED, the Response buttons LED and the wireless setting button LED on the wireless adapter indicate the condition of the respective devices.

Clicker

■ Power LED (Red)

LED status	Condition
Off	The power is off. Press the power button to turn on the power.
On	The power is on. Press the power button for over 3 seconds to turn off the power.
Flashing	The battery level is low. Replace with new batteries. ※The LED flashes for max. 5 seconds and then lights up after the power on or the wireless connection is successfully established.

■ Response buttons (LED) (Red)

LED status	Condition		
Off	The power is off or in standby status.		
On	The communication with the wireless adapter is established. ※LED is on for max.5 seconds after the connection establishment.		
Flashing	The clicker is trying to establish the connection with the wireless adapter or failed to establish the connection with the wireless adapter. ※ The clicker attempts to establish the connection for max. 7 seconds after pressing Response button. When succeeded: LED lights up after flashing. When failed: LED flashes for max. 5 seconds then goes off. <table border="1" data-bbox="475 1675 1390 1821"><tr><td> Caution</td><td>If Response button LED does not light up, the response is not accepted. Retry by pressing Response button again after the LED is off.</td></tr></table>	 Caution	If Response button LED does not light up, the response is not accepted. Retry by pressing Response button again after the LED is off.
 Caution	If Response button LED does not light up, the response is not accepted. Retry by pressing Response button again after the LED is off.		
High-speed flashing	The Wireless setting button is pressed. ※During the wireless setting, only [2/B] button flashes. Once the wireless setting is finished, [2/B] button goes off. Then [1/A] and [3/C] buttons flash and go off.		

Wireless adapter

■ Wireless setting button (LED) (Blue)

LED status	Condition
Off	The power of the computer is off.
Flashing	The power of the computer is on or the adapter is communicating with other device. ※The interval of flash changes depending on the condition of the communication.
High-speed flashing	The Wireless setting button is pressed.



For details about other LED status than starting SRS when using with Elmo Pen Tablet CRA-1, refer to the User's Guide of ELMO Wireless Slate/ Tablet.

Troubleshooting

If you have a problem or questions about this product, please read this troubleshooting guide first. If the problem still exists, consult the dealer from whom you purchased this product.

Communication between the clicker and the wireless adapter is unstable	
Is third-party wireless device or software installed?	If third-party wireless device or software is operating, it may conflict with the operations of the clicker. Do not operate third-party wireless device or software while using the clicker.
Are the clicker and the wireless adapter in proper condition?	Communication may become unstable if there is an obstruction between the clicker and the wireless adapter. Also, due to the inherent characteristics of wireless communication, the installation angle of both devices may affect the stability of the communication. Remove the obstruction or change the installation location. When holding the clicker, do not cover the upper part of it with your hand.
Is a wireless device or electronic equipment being used nearby?	Wireless devices or electronic equipments may interfere with the communication between the clicker and the wireless adapter. Refer to 〈Wireless setting for the clicker〉 and then perform the wireless settings. If this does not improve the situation, stop using the wireless device or electronic equipment, or move to a location with no interference. When using the clickers, keep at least 20cm distance between the clickers.

Cannot use SRS / SRS icon is not displayed	
Is a proper wireless adapter used?	Make sure to use the wireless adapter supplied with SRS. Do not use a wireless adapter supplied with the Pen Tablet.
Is the wireless setting between the clicker and the wireless adapter completed?	Wireless setting between the clicker and the wireless adapter needs to be set before you use a newly purchased clicker first. Refer to 〈Wireless setting for the clicker〉 for the wireless setting.

Cannot use Pen Tablet	
Using the Pen Tablet which is not compatible with SRS used?	When the firmware upgrade of your Pen Tablet is needed, consult with the dealer from whom you have purchased the Pen Tablet.
Is the wireless setting between the Pen Tablet and the wireless adapter completed?	Wireless setting between your Pen Tablet and the wireless adapter supplied with SRS needs to be set before you use your Pen Tablet with SRS. Refer to User's Guide of ELMO Wireless Slate/ Tablet for the wireless setting.

Specifications

Product specifications

■ Clicker

Model Name	CRV-CK-1
Operating Temperature	0°C - 40°C (32°F - 104°F)
Wireless Band Used	2.4GHz
Communication Range	Approx. 15m (49.2 feet) (differs depending on the usage conditions)
Power Supply	Alkaline dry cell AAA battery x 2
Continuous Operation Time	Approx. 150 hours (differs depending on the usage conditions)
Auto Power Off time	Approx. 300 seconds
Consumption Current	Max. 3.0V 60mA
External Dimensions	L110(4 11/32") × W64(2 17/32") × H26(1 1/32") (mm)
Weight	90g(0.1984lb) (including dry cell AAA battery x 2)

■ Wireless adapter

Model Name	CRV-CK-1R
Operating Temperature	0°C - 40°C (32°F - 104°F)
Wireless Band Used	2.4GHz
Number of clickers to be registered	Max. 50pcs
PC Interface	USB typeA plug (USB2.0 HI-SPEED)
Power Supply	USB bus power
Consumption Current	Max. 5.0V 50mA
External Dimensions	L64(2 17/32") × W22(7/8") × H10(13/32") (mm)
Weight	11g(0.02425lb)

■ Carrying Bag

Storage Temperature	-20°C - 60°C (-4°F - 140°F)
Number of clicker compartments	32
Number of Pen Tablet storage	1
External Dimensions	L425(16 47/64") × W365(14 9/16") × H165(6 1/2") (mm)
Weight	CRV-24:3.2kg(7.1lb) (Clicker x 24pcs) CRV-32:4.0kg(8.9lb) (Clicker x 32pcs) ※ (Including 1pce wireless adapter and accessories)

System Requirements

The SRS can be used in the following computer environments.

Computer model	IBM PC/AT compatible
Operating system (OS)	<ul style="list-style-type: none"> ■ Windows Microsoft Windows XP Home Edition / Professional SP2 Microsoft Windows Vista Home Basic / Home Premium / Business / Enterprise / Ultimate SP1 Microsoft Windows 7 Starter / Home Premium / Professional / Ultimate 64-bit versions supported (excluding Windows XP 64-bit version) ■ Mac Mac OS X 10.7.x / 6.x / 5.x Intel CPU
CPU	Intel Core 2 Duo 2 GHz equivalent or higher
Memory	2 GB or higher
Video board	Board compatible with Microsoft DirectX 9.0c
Hard disk	1 GB or higher empty space
Screen resolution	1024×768 pixels or higher 32-bit or higher
USB	USB 2.0 HI-SPEED
Compatible Document Cameras	<ul style="list-style-type: none"> · L-1ex · L-1zero · L-1zero r · TT-02RX · TT-02s · L-1n · P10S · P30S · P10 · P100 · P100N · HV-110u · FF-1 · CO-10 (i-Pochette) · TT-12 · L-12 · MO-1 (excluding Mac) · P30HD



- If a sound device cannot be used, some of the functions may not operate.
- Operation is not guaranteed for all computer environments.

Disclaimer

The information on this manual and Image Mate Accent for SRS are subject to change without prior notice.

The software already installed in your computer or other devices connected to your computer may affect the performance of Image Mate Accent for SRS.

ELMO is not liable for any direct or indirect damages resulting from the use of Image Mate Accent for SRS.

About Trademarks

ELMO and Image Mate are registered trademarks of ELMO Co., Ltd.

 is a trademark of ELMO Co., Ltd.

The full title for Windows® XP is the Microsoft® Windows® XP operating system.

The shortened form of the OS name is used in the text.

The full title for Windows® VISTA is the Microsoft® Windows® VISTA operating system.

The shortened form of the OS name is used in the text.

The full title for Windows® 7 is the Microsoft® Windows® 7 operating system.

The shortened form of the OS name is used in the text.

Microsoft and Windows are registered trademarks of the Microsoft Corporation in the U.S. and other countries.

All other company/product names described in this manual are trademarks or registered trademarks of their respective companies.

Repairable Period

■ Repairable Period

ELMO will maintain and keep spare parts for this product for eight years after the discontinuation of this product. After this period, ELMO will no longer offer repair service for this product.

ELMO CO., LTD. 6-14, Meizen-cho, Mizuho-ku, Nagoya, 467-8567, Japan

OVERSEAS SUBSIDIARY COMPANIES

ELMO USA CORP.

Headquarters

1478 Old Country Road
Plainview, NY 11803-5034, U.S.A
Tel:(516) 501-1400 Fax:(516) 501-0429

E-mail: elmo@elmousa.com Web: <http://www.elmousa.com>

West Coast Branch

Cypress Pointe Business Park
5676 Corporate Avenue
Cypress, CA 90630, U.S.A
Tel:(714) 828-8457 Fax:(714) 828-8429

ELMO Europe SAS

Immeuble Elysées la Défense,
7C, Place du Dôme,
92056 Paris la Défense, France
Tel: 33 (0) 1 73 02 67 06 Fax: 33 (0) 1 73 02 67 10

6X1CRVAC2 R2-Xdx