



Digital 6000

Instruction manual



The Digital 6000 Series 6

Features 7

Products in the Digital 6000 series 8

EM 6000 | EM 6000 DANTE 2-channel receiver 9

Package contents 9

Product overview 10

SKM 6000 handheld transmitter 11

Package contents 11

Product overview 12

SK 6000 bodypack transmitter 13

Package contents 13

Product overview 14

Modular L 6000 charger 15

Package contents 15

Product overview 16

Accessories 17

Charging modules for L 6000 charger 17

LM 6060 17

LM 6061 17

Rechargeable batteries and battery compartments 18

BA 60 rechargeable battery 19

B 60 battery compartment 19

BA 61 rechargeable battery 20

B 61 battery compartment 20

Microphones and cables 21

Microphone modules 21

Headset and Lavalier microphones 22

Line/instrument cables 22

AES3 cable for digital audio signals 22

Antennas and accessories 23

Omni-directional antennas 23

Directional antennas 23

Circularly polarized antennas 23

Antenna combiners/splitters 23

Antenna amplifiers 23

Antenna cables 23

Installing Digital 6000 series devices 24

Installing the EM 6000 25

Connectors on the rear of the device 26

Product overview for the rear side of the **EM 6000 26**

Product overview for the rear side of the **EM 6000 DAN-
TE 27**

Connecting/disconnecting the EM 6000 to/from the power supply system 28

Connecting the EM 6000 to a network 29

Outputting analog audio signals 30

Outputting digital audio signals 31

Outputting audio via a Dante™ network (EM 6000 DANTE only) 32

Connecting the word clock 33

Connecting remote antennas 35



- Cascading receivers 36
- Connecting rod antennas 37
- Installing the EM 6000 in a rack 38
- Installing the SKM 6000 39**
 - Inserting and removing the BA 60 rechargeable battery 40
 - Inserting and removing the B 60 battery compartment 42
 - Replacing the microphone module 44
- Installing the SK 6000 46**
 - Inserting and removing the BA 61 rechargeable battery 47
 - Inserting and removing the B 61 battery compartment 49
 - Mounting the antenna 51
 - Connecting a microphone to the SK 6000 52
 - Connecting an instrument or line source to the SK 6000 53
- Installing the L 6000 | LM 6060 | LM 6061 54**
 - Connecting/disconnecting the L 6000 to/from the power supply system 55
 - Connecting the L 6000 to a network 56
 - Installing the LM 6060 and LM 6061 charging modules in the L 6000 57
 - Installing the L 6000 in a rack 59
- Using Digital 6000 series devices 60**
- Using the EM 6000 61**
 - Operating elements on the front of the device 62
 - Product overview for the front of the **EM 6000 62**
 - Switching the EM 6000 on and off 64
 - Displays on the EM 6000 display panel 65
 - Buttons for navigating through the menu 66
 - Home screen 67
 - Home screen 1 68
 - Home screen 2 70
 - Home screen 3 71
 - Home screen 4 72
 - Setting options in the menu 73
 - Menu structure 74
 - Frequency menu item 75
 - Name menu item 77
 - Sync Settings menu item 78
 - Gain 80
 - Low Cut 81
 - Auto Lock 81
 - Display panel 82
 - Cable 82
 - Encryption menu item 83
 - Scan & Auto-Setup menu item 85
 - Performing a frequency scan and automatic frequency setup 85
 - Step 1a: New Scan 87
 - Step 1b: Use Old Scan 88



- Step 2: Editing displayed frequencies 89
- Step 3: Starting the automatic frequency setup 91
- Walktest menu item 92
- AF Output menu item 94
- Test Tone menu item 95
- Bank Edit menu item 97
- System menu item 99
 - Wordclock 100
 - Network 101
 - Device ID 103
 - Dante Settings (only EM 6000 DANTE) 104
 - Booster Feed 107
 - Brightness 108
 - Auto Setup 109
 - Info 110
 - Hardware 110
 - Help 111
 - TX Update 111
 - Reset 112
- Using the headphone output 113
- Updating the firmware of the receiver 114
- Updating the firmware of the Dante™ interface 114
- Status messages 115
- Using the SKM 6000 117**
 - Operating elements of the SKM 6000 handheld transmitter 118
 - Switching the SKM 6000 on and off 119
 - Displays on the SKM 6000 handheld transmitter display panel 120
 - Operating the SKM 6000 menu 121
 - Navigating through the menu 121
 - Making changes in a menu item 121
 - Menu item overview 121
 - Updating the firmware of the SKM 6000 124
- Using the SK 6000 125**
 - Operating elements of the SK 6000 bodypack transmitter 126
 - Switching the SK 6000 on and off 127
 - Displays on the SK 6000 bodypack transmitter display panel 128
 - Operating the SK 6000 menu 129
 - Navigating through the menu 129
 - Making changes in a menu item 129
 - Menu item overview 129
 - Updating the firmware of the SK 6000 132
- Using the L 6000 133**
 - Switching the L 6000 on and off 134
 - Charging rechargeable batteries 135
 - Meaning of the LEDs on the L 6000 charger and LM 6060 and LM 6061 charging modules 136
 - L 6000 status LEDs 136



- LM 6060 and LM 6061 status LEDs 137
- LM 6060 and LM 6061 status LEDs in storage mode 137

- Preparing rechargeable batteries for storage (storage mode) 138

- Meaning of the status LEDs in storage mode 138

- Resetting settings (factory reset) 139

- Updating the firmware 140

- Operating the L 6000 via a network 141

Establishing a radio link 142

- Adjusting frequencies 142

- Encrypting the radio link 142

- Meaning of the Link Quality Indicator 142

- Green range from 50% to 100%: 143

- Yellow range from 20% to 49%: 143

- Orange range from 1% to 19%: 143

- Red range 0%: 143

Synchronizing devices 144

User knowledge 145

Recommendations for using antennas 146

- Rod antennas (included in the delivery) 146

- Remote antennas 146

- Active vs passive antennas 146

- General recommendation 146

- Types of remote antenna 146

- Losses due to cable properties and length 147

Equidistant frequency grid 148

Word clock scenarios for digital audio (AES3 and Dante™) 149

- Word clock with analog audio 149

- Word clock with digital audio 149

- Defining the master and slave 150

Overview 151

Product variants 152

- EM 6000 | EM 6000 DANTE product variants 153

- SKM 6000 product variants 153

- SK 6000 product variants 155

- L 6000 product variants 155

- LM 6060 and LM 6061 product variants 156

Frequency table 157

Specifications 158

- System 159

- EM 6000 160

- EM 6000 DANTE 161

- SKM 6000 163

- SK 6000 164

- L 6000 165

- LM 6060 | LM 6061 166

- BA 60 | BA 61 167



Cleaning and maintenance 168

Cleaning the sound inlet basket of the microphone module 168

Cleaning the SK 6000 bodypack transmitter contacts. 169

Cleaning the L 6000 charger 169



The Digital 6000 Series



When perfection is required there can be no compromises. The Digital 6000 system combines experience, high standards and excellent instincts for day-to-day work in the modern live event industry into one simple promise: no compromises in RF robustness, sound or workflow.

The 2-channel system delivers quality, reliability and efficiency in a compact 19-inch/1 RU format. The series incorporates the renowned Long Range mode with the proprietary audio codec (SeDAC) of the wireless masterpiece, Digital 9000.

True bit diversity evaluates the quality of each individual bit and combines the bits from the two parallel reception streams. In combination with a switching bandwidth of 244 MHz and equidistant frequency grid, it provides the greatest possible transmission reliability even in demanding RF environments. Digital 6000 is compatible with many other Sennheiser antennas and capsules and has an easy-to-follow user interface on clear OLED displays, digital and analog outputs and AES 256 encryption. The Dante Version with an Audinate Brooklyn II Card offers an additional RJ-45 connector.

The series is ideal for touring and rental companies, theater and musical productions, broadcasting, large places of worship and corporate applications.

The 6000 series includes a 2-channel receiver, a bodypack transmitter, a handheld transmitter and a modular 19-inch rack-mounted charger.

Digital 6000 combines the benefits of modern audio technology with an intelligent operating concept. The frequency range can be scanned directly with the receiver, which then distributes free frequencies within the network. The equipment can also be monitored and configured via Wireless System Manager (WSM) software. The high-quality OLED display provides an overview with a multitude of operating data. Intelligent home screens lead you directly to important contextual information with no need for time-consuming navigation. In addition to the popular RF graphs, the link quality display (LQI) allows a real-time evaluation of the wireless link quality. That allows you to identify and eliminate risks immediately.

Digital 6000 integrates seamlessly into existing digital and analog infrastructures. The EM 6000 receiver has a digital AES3 output with word clock inputs and outputs, high-quality transformer-balanced analog XLR-3 outputs, 6.3 mm (1/4") jack outputs and a 6.3 mm (1/4") headphone output.



The Dante version with an Audinate Brooklyn II card offers an additional Amphenol RJ-45 jack plug for integrating the receiver into a Dante network.

The Digital 6000 series includes a 2-channel receiver available in 2 versions, a bodypack transmitter, a handheld transmitter and a modular 19-inch rack-mounted charger.

Features

- A 2-channel receiver in a compact 19-inch/1 RU format combines performance, efficiency and clarity
- The wireless transmission uses the legendary Long Range mode with SeDAC codec from the masterpiece, Digital 9000 – for maximum transmission quality
- True bit diversity, error correction and masking protect the transmission channels even in demanding RF environments
- Future-proof and usable worldwide thanks to the large 244 MHz switching bandwidth
- The equidistant frequency grid guarantees the highest possible number of channels and simplest configuration, even in the most congested frequency bandwidths.
- Sophisticated transmitter electronics prevent disruptive intermodulation even with multiple transmitters in confined spaces
- Low system latency of just 3 ms
- Multiple outputs for analog and digital systems (XLR, jack socket, AES, Dante (EM 6000 Dante only))
- AES 256 encryption for maximum data security
- Simple setup of multi-channel solutions: With the integrated antenna splitters, you can cascade up to 8 receivers without any additional hardware
- Compatible with a huge number of Sennheiser and Neumann capsules, Lavalier microphones (clip-on microphones), headsets and antenna systems
- High-resolution white OLED display with four easy access home screens
- Simple, intuitive user concept for setup and monitoring
- WSM-compatible
- Transmitter equipped with lithium-ion rechargeable batteries
- Modular 19 inch/1 RU charger

For more information about the individual products in the Digital 6000 series, see “Products in the Digital 6000 series”.

For information about the available accessories, see “Accessories”.



Products in the Digital 6000 series



Click the name of the particular product to learn more about it.



You can also find more information here:

- A variety of frequency variants are available from the SKM 6000 and SK 6000. You can find more information under “Product variants”.
- You can find technical specifications about the individual products under “Specifications”.
- You can find information about installing the products under “Installing Digital 6000 series devices”.
- You can find information about operating the products under “Using Digital 6000 series devices”.



EM 6000 | EM 6000 DANTE 2-channel receiver



The digital 2-channel receiver works via a switching bandwidth of 244 MHz (470 to 714 MHz) that is covered by three transmitter versions (470 to 558 MHz, 550 to 638 MHz and 630 to 718 MHz). For larger 4-channel systems, you can cascade up to EM 6000s without using additional antenna splitters and you then require only one pair of antennas.

The 2-channel receiver is available in 2 variants:

- **EM 6000**
- **EM 6000 DANTE**

The EM 6000 DANTE variant is identical in construction to the EM 6000. The only difference is that it also has an integrated Dante™ interface (Audiante Brooklyn II) for connecting the device to a Dante™ network.

i You can find more detailed information about the EM 6000 in the following sections:

- **Installation:** “Installing the EM 6000”
- **Operation:** “Using the EM 6000”
- **Technical data:** “EM 6000” or “EM 6000 DANTE”

Package contents

- 1 EM 6000 or EM 6000 DANTE 2-channel receiver
- 1 mains cables (EU, UK, or US variant)
- 2 antennas
- 2 antenna cables (BNC, 50 Ω)
- 4 rubber feet
- 1 short instructions
- 1 manual with safety instructions
- 1 manual with technical data



Product overview

View of the front side:



Rear view of the EM 6000:



Rear view of the EM 6000 DANTE:





SKM 6000 handheld transmitter



A variety of frequency variants are available from the SKM 6000 handheld transmitter. You can find more information under “SKM 6000 product variants”.

For more detailed information about installing and operating the SKM 6000 handheld transmitter, see “Installing the SKM 6000” and “Using the SKM 6000”.

Package contents

- 1 SKM 6000 handheld transmitter
- 1 MZQ 9000 microphone clamp
- 1 short instructions
- 1 manual with safety instructions
- 1 manual with technical data



[Product overview](#)

View of the front side:



View of the rear side with the display:





SK 6000 bodypack transmitter



A variety of frequency variants are available from the SK 6000 bodypack transmitter. You can find more information under “SK 6000 product variants”.

For more detailed information about installing and operating the SK 6000 bodypack transmitter, see “Installing the SK 6000” and “Using the SK 6000”.

Package contents

- 1 SK 6000 bodypack transmitter
- 1 antenna
- 1 belt clip
- 1 short instructions
- 1 manual with safety instructions
- 1 manual with technical data



Product overview

View of the front side:



View without rechargeable battery:





Modular L 6000 charger



The L 6000 charger is used to charge the BA 60 and BA 61 rechargeable batteries. The 2 charging modules LM 6060 (for the BA 60) and LM 6061 (for the BA 61) are required to do so. The rechargeable batteries and charging modules are available separately.

i You can find more detailed information about the L 6000 charger and the LM 6060 and LM 6061 charging modules in the following sections:

- **Information about the rechargeable batteries and charging modules:** “Rechargeable batteries and battery compartments” and “Charging modules for L 6000 charger”
- **Installation:** “Installing the L 6000 | LM 6060 | LM 6061”
- **Operation:** “Using the L 6000”
- **Technical data:** “L 6000” or “LM 6060 | LM 6061”

Package contents

- 1 L 6000 charger
- 1 mains cables (EU, UK, or US variant)
- 4 dummy caps including screws (preassembled)
- 4 rubber feet
- 1 short instructions
- 1 manual with safety instructions
- 1 manual with technical data



[Product overview](#)

View with the charging modules and rechargeable batteries inserted:



View with the LM 6060 charging modules without rechargeable batteries inserted:



View with the LM 6061 charging modules without rechargeable batteries inserted:





Accessories

Various accessory parts are available for the Digital 6000 series.

Charging modules for L 6000 charger

LM 6060

The LM 6060 charging module is installed in the L 6000 charger to charge the BA 60 rechargeable battery.

4 Torx 10 screws for mounting in the L 6000 are included in the delivery.



Sennheiser article number 507198

LM 6061

The LM 6061 charging module is installed in the L 6000 charger to charge the BA 61 rechargeable battery.

4 Torx 10 screws for mounting in the L 6000 are included in the delivery.



Sennheiser article number 507199



Rechargeable batteries and battery compartments

Rechargeable batteries:

We recommend using the **BA 60** rechargeable battery (for the SKM 6000 handheld transmitter) and **BA 61** rechargeable battery (for the SK 6000 bodypack transmitter) that are available as accessories to operate the transmitters. These lithium-ion rechargeable batteries have been especially developed to achieve the optimum service life and operational reliability for the transmitters.

Lithium-ion rechargeable batteries do not have a memory effect and have a greater power density than primary batteries and NiMH rechargeable batteries. In addition, the remaining battery life of the transmitters can be read to the exact minute on the transmitter and receiver.

These rechargeable batteries must be charged only with Sennheiser L 6000 and L 60 chargers.

Battery compartments:

With the **B 60** battery compartment (for the SKM 6000 handheld transmitter) and **B 61** battery compartment (for the SK 6000 bodypack transmitter) that are also available as accessories, you can use AA batteries and rechargeable AA batteries. However, the battery life of the transmitters is shorter than the BA 60 and BA 61 rechargeable battery life and depends heavily on the quality, capacitance and age of the batteries or rechargeable batteries used.

The remaining battery life can only be roughly estimated from the battery icon and a specific battery life cannot be displayed. At the end of the battery life, the transmitters may also experience oscillating on-off switching behavior.

The use of battery compartments may be a solution for rehearsals or to avoid disasters, but should generally not be considered as part of an event.



BA 60 rechargeable battery

The BA 60 rechargeable battery is intended to operate the SKM 6000 handheld transmitter.



Sennheiser article number 504702

B 60 battery compartment

The B 60 battery compartment is intended to operate the SKM 6000 handheld transmitter.



Sennheiser article number 504700



BA 61 rechargeable battery

The BA 61 rechargeable battery is intended to operate the SK 6000 bodypack transmitter.



Sennheiser article number 504703

B 61 battery compartment

The B 61 battery compartment is intended to operate the SK 6000 bodypack transmitter.



Sennheiser article number 504701



Microphones and cables

Microphone modules

We recommend using the following microphone modules with the SKM 6000 handheld transmitter.

Module	Features	Article no.
MMD 835-1 BK	Dynamic, cardioid, black	502575
MMD 845-1 BK	Dynamic, super-cardioid, black	502576
MMD 865-1 BK	Capacitor, super-cardioid, black	502581
MMD 935-1 BK	Dynamic, cardioid, black	502577
MMD 945-1 BK	Dynamic, super-cardioid, black	502579
MMK 965-1 BK	Capacitor, switchable, black	502582
MMK 965-1 NI	Capacitor, switchable, nickel	502584
MD 9235 BK	Dynamic, super-cardioid, black	502585
MD 9235 NI	Dynamic, super-cardioid, nickel	502586
MD 9235 NI/BK	Dynamic, super-cardioid, nickel-black	502591
ME 9002	Electret, omni-directional, black	502587
ME 9004	Electret, cardioid, black	502588
ME 9005	Electret, super-cardioid, black	502589
Neumann KK 204	Capacitor, cardioid, nickel	008651
Neumann KK 204 BK	Capacitor, cardioid, black	008652
Neumann KK 205	Capacitor, super-cardioid, nickel	008653
Neumann KK 205 BK	Capacitor, super-cardioid, black	008654

i You can also use microphone modules from the **evolution wireless G3** and **2000** series with the SKM 6000 handheld transmitter.

You can find more information about the individual microphone modules on their respective product pages at www.sennheiser.com or www.neumann.com.



Headset and Lavalier microphones

We recommend using the following Lavalier microphones and headset microphones with the SK 6000 bodypack transmitter.

Microphone	Features	Article no.
MKE 1-4	Lavalier microphone, omni-directional	502167
MKE 2-4	Lavalier microphone, omni-directional	004736
MKE 40-4	Lavalier microphone, cardioid	003579
HSP 2	Headset microphone, omni-directional	009862
HSP 4	Headset microphone, cardioid	009864
SL Headmic 1-4	Headset microphone, omni-directional	506905

i You can find more information about the individual microphones on their respective product pages at www.sennheiser.com.

Line/instrument cables

The following cable is available to connect instruments and line sources to the SK 6000 bodypack transmitter:

- Sennheiser **CI 1-4**
6.3 mm (1/4") jack plug (silent plug) to 3-pin audio connector (Sennheiser special connector)

AES3 cable for digital audio signals

To connect the digital audio output of the EM 6000 to a digital mixing console.

- **GZL AES 10**, AES3 cable, 10 m (32 ft), 110 Ω, double-shielded, article no. 502432



Antennas and accessories

The following antenna components are available as accessory parts.

Omni-directional antennas

- **A 1031-U**, passive omni-directional antenna, article no. 004645
- **A 3700**, active omni-directional antenna, article no. 502195

Directional antennas

- **A 2003 UHF**, passive directional antenna, article no. 003658
- **AD 3700**, active directional antenna, article no. 502197

Circularly polarized antennas

- **A 5000 CP**, passive circularly polarized helical antenna, article no. 500887

Antenna combiners/splitters

- **ASA 3000**, active antenna splitter 2×1:8
 - **ASA 3000-EU** variant, article no. 009423
 - **ASA 3000-UK** variant, article no. 009408
 - **ASA 3000-US** variant, article no. 009407
- **ASA 1**, active antenna splitter 2×1:4, article no. 503165

Antenna amplifiers

- **AB 3700**, broadband antenna amplifier, article no. 502196
- **AB 9000**, antenna amplifier
 - **AB 9000 A1-A8** variant, article no. 504708
 - **AB 9000 B1-B8** variant, article no. 504709

Antenna cables

- **GZL 1019**, BNC/BNC coaxial cable, antenna cable with 50 Ω characteristic (wave) impedance
 - **GZL 1019-A1** variant, 1 m (3 ft), article no. 002324
 - **GZL 1019-A5** variant, 5 m (16 ft), article no. 002325
 - **GZL 1019-A10** variant, 10 m (32 ft), article no. 002326
- **RF cable**, BNC cable for daisy chaining the antenna signal, 50 Ω, 0.25 m (9 27/32"), article no. 087969
- **RF cable**, BNC cable for daisy chaining the **word clock** signal, 75 Ω, 0.25 m (9 27/32"), article no. 087972



Installing Digital 6000 series devices

You can find information about installing and connecting Digital 6000 series devices in the following sections.

- **EM 6000** 2-channel receiver >> “Installing the EM 6000”
- **SKM 6000** handheld transmitter >> “Installing the SKM 6000”
- **SK 6000** bodypack transmitter >> “Installing the SK 6000”
- **L 6000** charger and **LM 6060**, **LM 6061** charging modules >> “Installing the L 6000 | LM 6060 | LM 6061”



You can find information about operating the products under “Using Digital 6000 series devices”.



Installing the EM 6000

These sections contain detailed information about installing the EM 6000. You can find information about operating the EM 6000 under “Using the EM 6000”.



Connectors on the rear of the device

Product overview for the rear side of the EM 6000

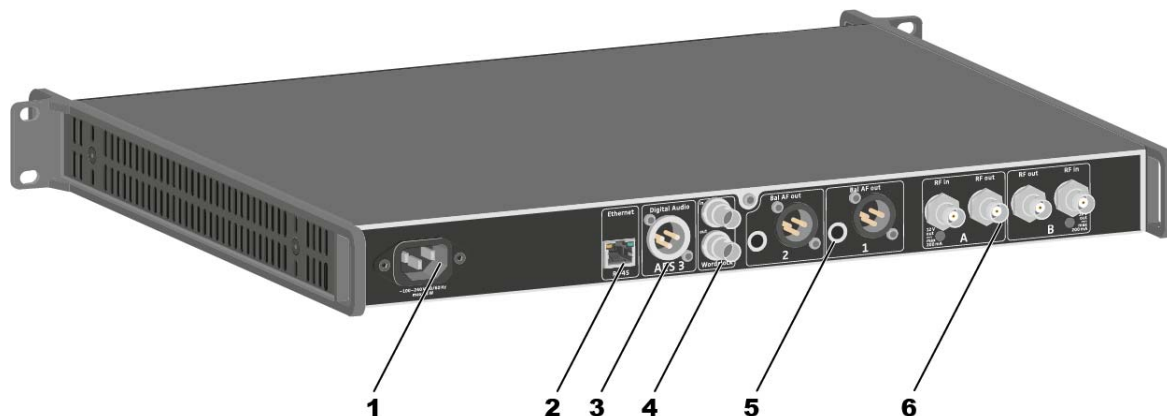

- 1** Power socket
 - See “Connecting/disconnecting the EM 6000 to/from the power supply system”
- 2** Ethernet socket for controlling the device via the network and Sennheiser WSM
 - See “Connecting the EM 6000 to a network”
- 3** **Digital Audio AES 3** digital audio output
 - See “Outputting digital audio signals”
- 4** **Word clock** BNC sockets
 - See “Connecting the word clock”
- 5** **Bal AF out** analog audio outputs for the CH 1 and CH 2 channels
 - One XLR and 6.3 mm (1/4") jack per channel, transformer-balanced, parallel
 - See “Outputting analog audio signals”
- 6** BNC antenna inputs and BNC antenna outputs for cascading
 - See “Connecting remote antennas”
 - See “Connecting rod antennas”
 - See “Recommendations for using antennas”



Product overview for the rear side of the EM 6000 DANTE

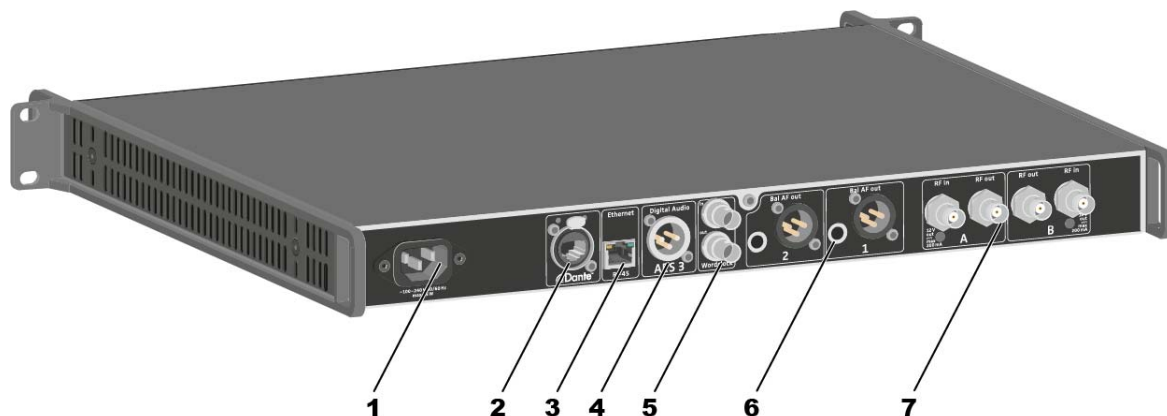

- 1** Power socket
 - See “Connecting/disconnecting the EM 6000 to/from the power supply system”
- 2** The Dante™ interface
 - See “Outputting audio via a Dante™ network (EM 6000 DANTE only)”
- 3** Ethernet socket for controlling the device via the network and Sennheiser WSM
 - See “Connecting the EM 6000 to a network”
- 4** **Digital Audio AES 3** digital audio output
 - See “Outputting digital audio signals”
- 5** **Word clock** BNC sockets
 - See “Connecting the word clock”
- 6** **Bal AF out** analog audio outputs for the CH 1 and CH 2 channels
 - One XLR and 6.3 mm (1/4") jack per channel, transformer-balanced, parallel
 - See “Outputting analog audio signals”
- 7** BNC antenna inputs and BNC antenna outputs for cascading
 - See “Connecting remote antennas”
 - See “Connecting rod antennas”
 - See “Recommendations for using antennas”



Connecting/disconnecting the EM 6000 to/from the power supply system

To connect the EM 6000 to the power supply system:

- ▷ Connect the mains cable IEC connector to the power socket on the rear side of the EM 6000.
- ▷ Connect the mains cable plug into a suitable wall socket.

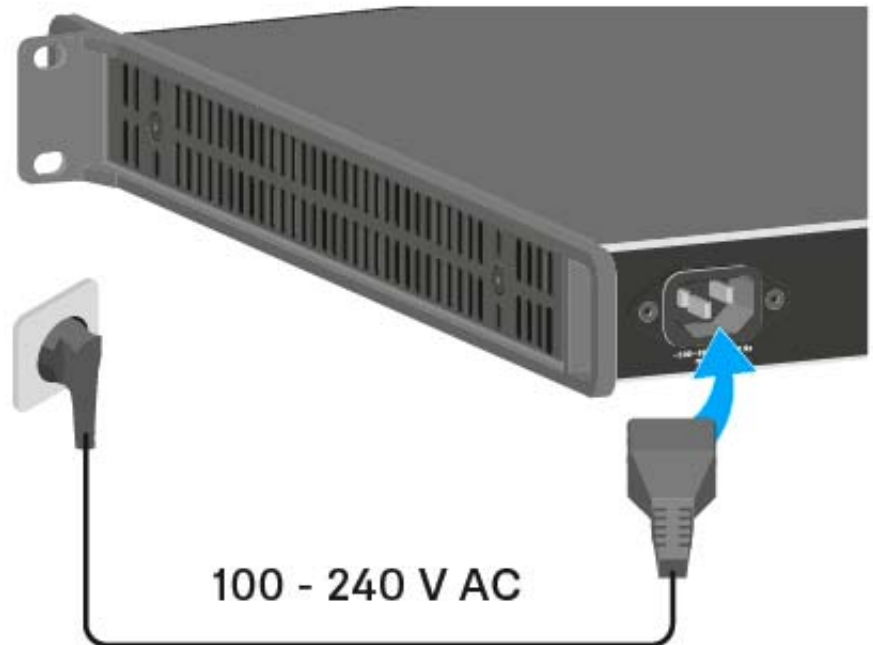

i Once the EM 6000 is connected to the power supply, the **On/Off** button lights up dimmed. If the booster voltage for antennas is activated in the menu (see “Booster Feed” under “System menu item”), it is active already before you switch on and after you switch off the EM 6000.

To completely disconnect the EM 6000 from the power supply system:

- ▷ Unplug the mains cable plug from the wall socket.
- ▷ Unplug the mains cable IEC connector from the power socket on the rear side of the EM 6000.



Connecting the EM 6000 to a network

You can monitor and control one or more EM 6000s via a network connection using **Sennheiser Wireless Systems Manager (WSM)** software.

i The network does not have to be a homogeneous network including only receivers. You can integrate the EM 6000 into your existing network infrastructure with any other types of devices.

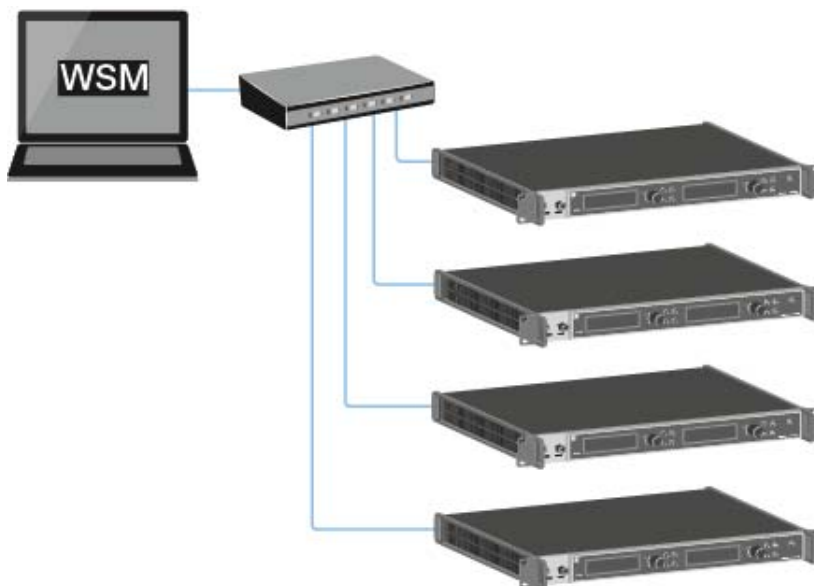

To connect the EM 6000 to a network:

- ▷ Connect a network cable with an RJ-45 connector (Cat5 at minimum) to the **Ethernet** socket on the rear side of the EM 6000.



i For more information about controlling devices via the **Sennheiser Wireless Systems Manager (WSM)** software, refer to the instruction manual for the software. You can download the software at www.sennheiser.com/download.



Outputting analog audio signals

Each of the two channels **CH 1** and **CH 2** on the EM 6000 have both a symmetrical XLR-3M output socket and a symmetrical 6.3 mm (1/4") jack output socket.

- Always use only one of the two **Bal AF out** output sockets for each channel.

The two output sockets of a channel are connected in parallel.

To connect an XLR cable:



To connect a jack cable:





Outputting digital audio signals

The EM 6000 can also output digital audio.

To do so, use the **Digital Audio AES 3** output on the rear side of the EM 6000.

i The Digital Audio AES 3 output socket is designed as an XLR-3M socket. Use an XLR cable with a resistance of 110 ohm. Conventional XLR audio cables may not transfer the digital audio signal correctly.





Outputting audio via a Dante™ network (EM 6000 DANTE only)

The EM 6000 DANTE has a Dante interface (Audinate Brooklyn II) for outputting digital audio signals via a Dante™ network.

- ▷ Connect a Dante-enabled network cable to the Dante socket on the rear side of the EM 6000 DANTE.



We recommend using an Ethernet connector as shown in the figure.

i You can find more information about Dante™ here:

- “Word clock scenarios for digital audio (AES3 and Dante™)”
- “System menu item”



Connecting the word clock

You can use the internal word clock on the EM 6000 or connect an external word clock.

You can also output the external word clock and cascade it up to 16 receivers.

The word clock output transmits only the external word clock that is connected via the word clock input. The internal word clock is not output via the word clock output.

i For more information about the word clock, see “Word clock scenarios for digital audio (AES3 and Dante™)”.

To connect an external word clock:



- ▷ Use a coaxial BNC cable (75 Ω) to connect the external word clock to the **Wordclock In** input.

A suitable cable is available as an accessory part. See “Antenna cables”.



To cascade the word clock:

- ▷ Connect the **Wordclock In** input of the next EM 6000 to the **Wordclock Out** output of the previous EM 6000.

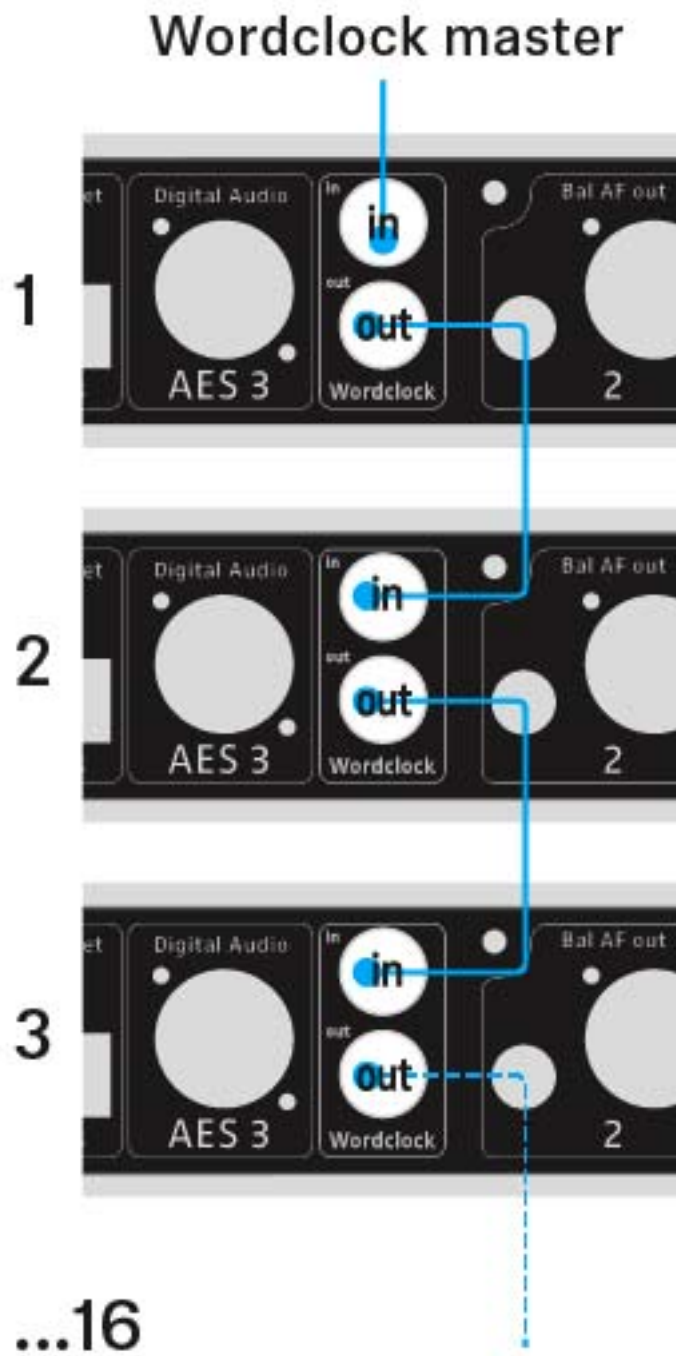



Connecting remote antennas

We recommend using remote antennas. You can also find useful information about using antennas under “Recommendations for using antennas”.

To connect remote antennas:

- ▷ Connect the first antenna to the **RF in** socket for **Antenna A** on the rear side of the EM 6000.
- ▷ Connect the second antenna to the **RF in** socket for **Antenna B** on the rear side of the EM 6000.

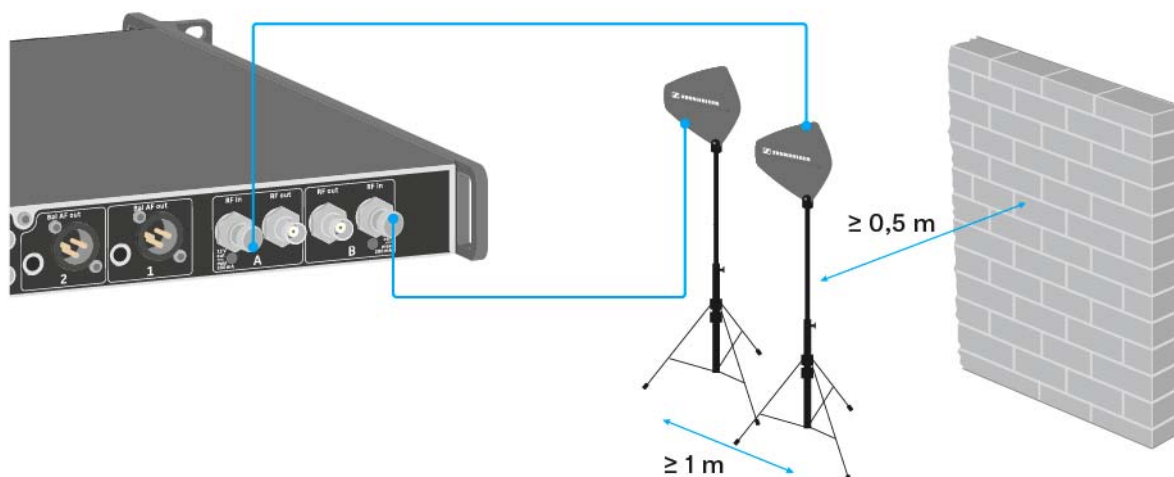

Note the following information when setting up antennas:

- ▷ Maintain a distance of at least 1 m (3 ft) between the antennas.
- ▷ Maintain a distance of at least 0.5 m (1.5 ft) between the antennas and the nearest wall.
- ▷ Position the antennas so that there is a direct line of sight between the transmitters and the antennas.
- ▷ Refer to the more detailed information under “Remote antennas”.
- ▷ Activate the booster feed in the EM 6000 menu if you are using active antennas. See “Booster Feed” in the chapter “System menu item”. Alternatively, use an external antenna amplifier.



Cascading receivers

For larger 4-channel systems, you can cascade up to 8 receivers without using additional antenna splitters and you then require only one pair of antennas.

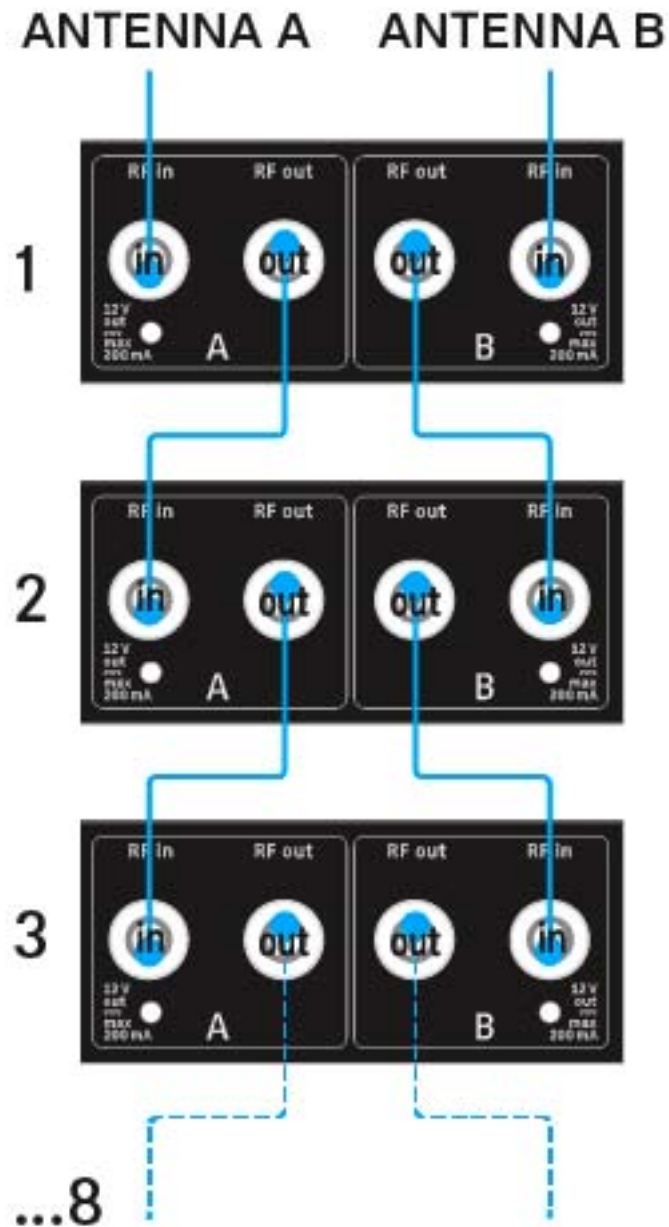



Connecting rod antennas

We recommend using remote antennas. You can also find useful information about using antennas under “Recommendations for using antennas”.

To connect the supplied rod antennas:

- ▷ Connect the first rod antenna to the **RF in** socket for **Antenna A** on the rear side of the EM 6000.
- ▷ Connect the second rod antenna to the **RF in** socket for **Antenna B** on the rear side of the EM 6000.
- ▷ Gently angle the rod antennas to the left and right as shown in the figure.

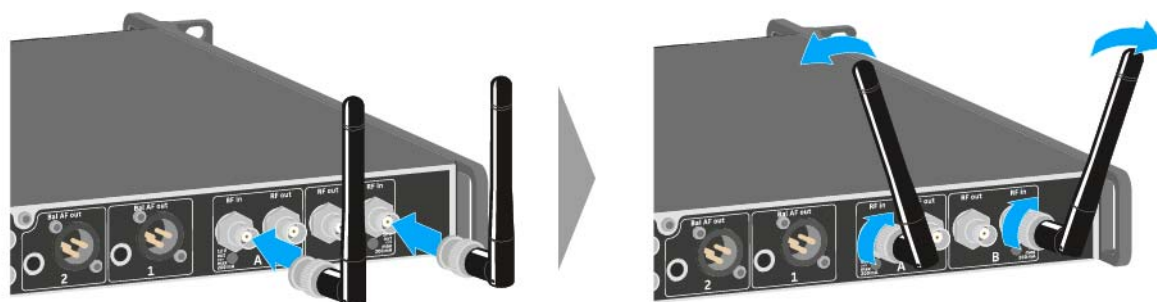



Installing the EM 6000 in a rack

You can install the EM 6000 2-channel receiver in any conventional 19" rack. The rack mounting angles are already attached to the device.

Always observe the following information during rack mounting.

- Support the EM 6000 after installation in the rack.

Due to the weight and depth of the device, there is a risk that it may break off in the rack and become damaged as a result.

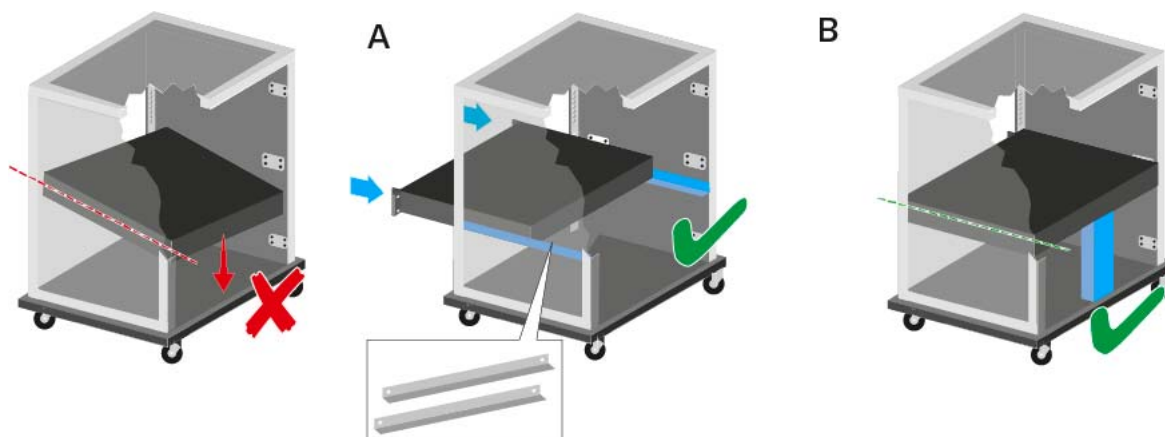

Version A:

- Use special rack mounting rails.
- The design of the rack used must be suitable for the installation of these mounting rails.

Version B:

- Use a suitable object to support the device on the rear side.
- Ensure that this object cannot become loose.

ATTENTION

Material damages caused by devices overheating

When there is insufficient ventilation, the devices mounted in the rack may overheat.

- Ensure that there is sufficient ventilation in the rack, particularly if several devices are installed. If necessary, install a fan in the rack.

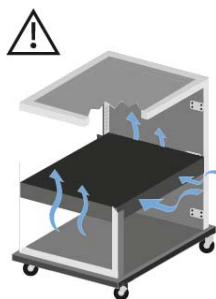



Installing the SKM 6000

These sections contain detailed information about installing the SKM 6000.

You can find information about operating the SKM 6000 under “Using the SKM 6000”.



Inserting and removing the BA 60 rechargeable battery

i We recommend using the BA 60 rechargeable battery instead of the B 60 battery compartment. You can find more information about this subject under “Rechargeable batteries and battery compartments”.

- ▷ Charge the BA 60 rechargeable battery before using it for the first time. For information about charging, see “Charging rechargeable batteries”.



To insert the BA 60 rechargeable battery into the SKM 6000 handheld transmitter:

- ▷ Insert the BA 60 rechargeable battery into the SKM 6000 handheld transmitter as shown in the figure until it audibly clicks into place.





To remove the BA 60 rechargeable battery from the SKM 6000 handheld transmitter:

- ▷ Press the two catches as shown in the figure and pull the BA 60 rechargeable battery out of the SKM 6000 handheld transmitter.

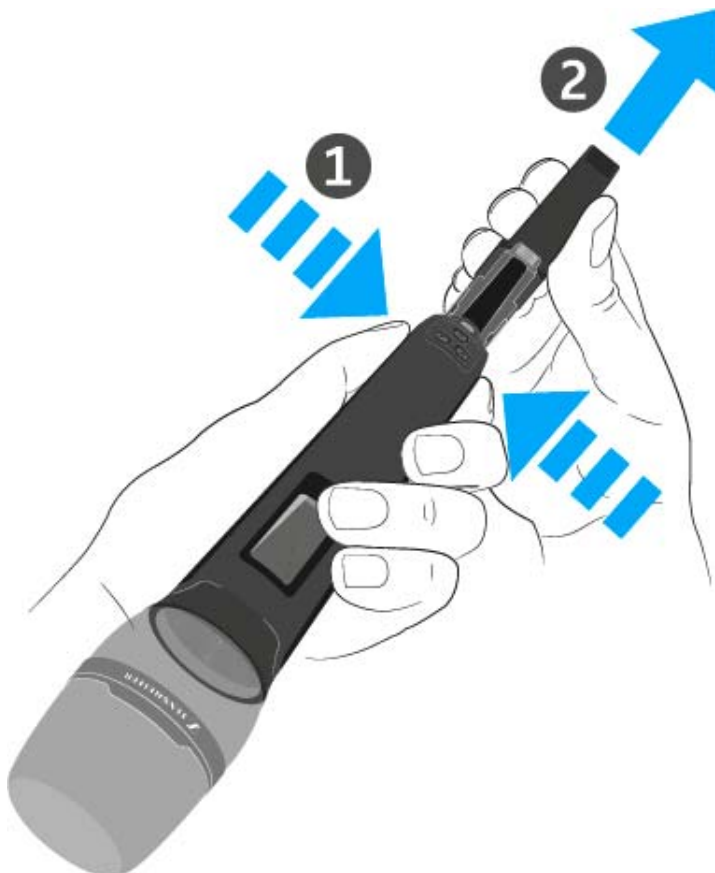

CAUTION

Damage to the handheld transmitter and/or rechargeable battery/battery compartment

If you touch the following contacts, they may become dirty or bent.

- BA 60 rechargeable battery charging and data contacts
- B 60 battery compartment contacts
- ▷ Do not touch the BA 60 rechargeable battery contacts or the B 60 battery compartment contacts.





Inserting and removing the B 60 battery compartment

i We recommend using the BA 60 rechargeable battery instead of the B 60 battery compartment. You can find more information about this subject under “Rechargeable batteries and battery compartments”.

Before using the battery compartment, you must insert the batteries as shown in the figure.

- ▷ Please observe correct polarity when inserting the batteries.
- ▷ Use only high-quality AA batteries (e.g. lithium or alkaline manganese batteries) or high-quality NiMH rechargeable batteries in the B 60 battery compartment.

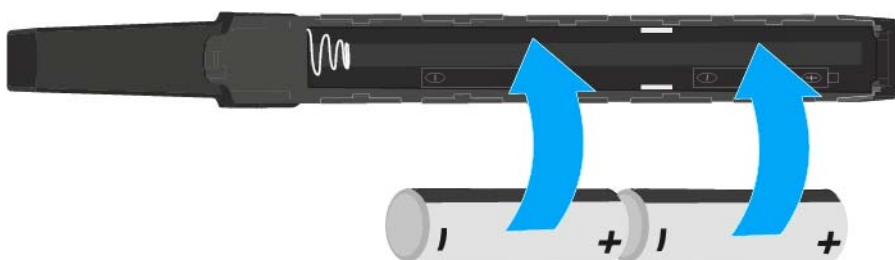

To insert the B 60 battery compartment into the SKM 6000 handheld transmitter:

- ▷ Insert the B 60 battery compartment into the SKM 6000 handheld transmitter as shown in the figure until it audibly clicks into place.





To remove the B 60 battery compartment from the SKM 6000 handheld transmitter:

- ▷ Press the two catches as shown in the figure and pull the B 60 battery compartment out of the SKM 6000 handheld transmitter.

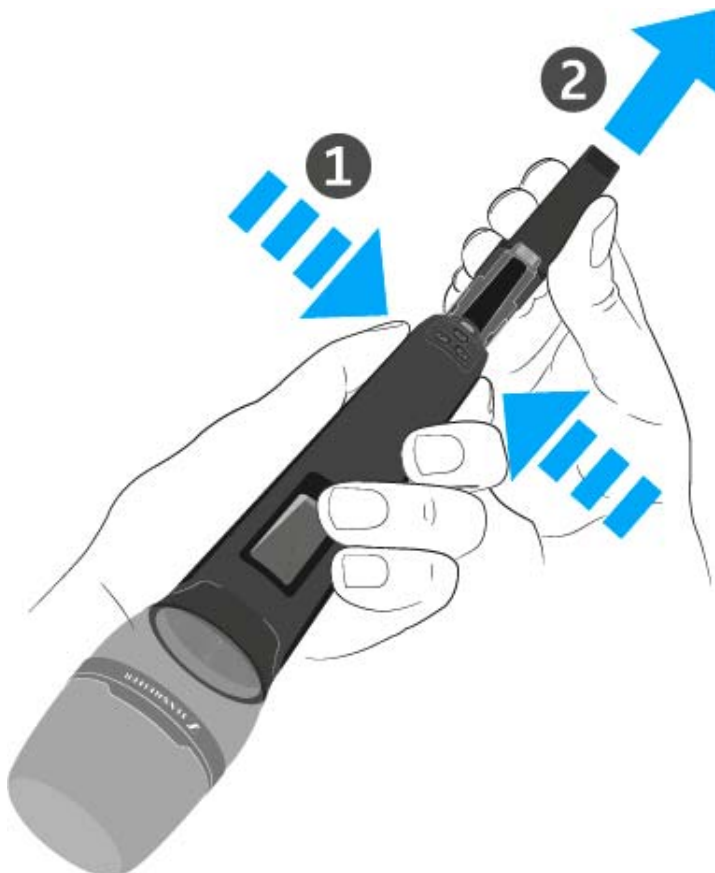

CAUTION

Damage to the handheld transmitter and/or rechargeable battery/battery compartment

If you touch the following contacts, they may become dirty or bent.

- BA 60 rechargeable battery charging and data contacts
- B 60 battery compartment contacts
- ▷ Do not touch the BA 60 rechargeable battery contacts or the B 60 battery compartment contacts.





Replacing the microphone module

We recommend using the following microphone modules with the SKM 6000 handheld transmitter.

Module	Features	Article no.
MMD 835-1 BK	Dynamic, cardioid, black	502575
MMD 845-1 BK	Dynamic, super-cardioid, black	502576
MMD 865-1 BK	Capacitor, super-cardioid, black	502581
MMD 935-1 BK	Dynamic, cardioid, black	502577
MMD 945-1 BK	Dynamic, super-cardioid, black	502579
MMK 965-1 BK	Capacitor, switchable, black	502582
MMK 965-1 NI	Capacitor, switchable, nickel	502584
MD 9235 BK	Dynamic, super-cardioid, black	502585
MD 9235 NI	Dynamic, super-cardioid, nickel	502586
MD 9235 NI/BK	Dynamic, super-cardioid, nickel-black	502591
ME 9002	Electret, omni-directional, black	502587
ME 9004	Electret, cardioid, black	502588
ME 9005	Electret, super-cardioid, black	502589
Neumann KK 204	Capacitor, cardioid, nickel	008651
Neumann KK 204 BK	Capacitor, cardioid, black	008652
Neumann KK 205	Capacitor, super-cardioid, nickel	008653
Neumann KK 205 BK	Capacitor, super-cardioid, black	008654

i You can also use microphone modules from the **evolution wireless G3** and **2000** series with the SKM 6000 handheld transmitter.



To change the microphone module:

- ▷ Screw or unscrew the microphone module onto or from the handheld transmitter as shown in the figure.



- i** With some microphone modules, the upper part of the microphone basket can be screwed off. Ensure that you always completely unscrew the microphone module.

CAUTION

Damage to the microphone module

If you touch the contacts, they may become dirty or bent.

- ▷ Do not touch the handheld transmitter contacts or the microphone module contacts.





Installing the SK 6000

These sections contain detailed information about installing the SK 6000.

You can find information about operating the SK 6000 under “Using the SK 6000”.



Inserting and removing the BA 61 rechargeable battery

i We recommend using the BA 61 rechargeable battery instead of the B 61 battery compartment. You can find more information about this subject under “Rechargeable batteries and battery compartments”.

- ▷ Charge the BA 61 rechargeable battery before using it for the first time. For information about charging, see “Charging rechargeable batteries”.



To insert the BA 61 rechargeable battery into the SK 6000 bodypack transmitter:

- ▷ Insert the BA 61 rechargeable battery into the SK 6000 bodypack transmitter as shown in the figure until it audibly clicks into place.





To remove the BA 61 rechargeable battery from the SK 6000 bodypack transmitter:

- ▷ Press the two catches as shown in the figure and pull the BA 61 rechargeable battery out of the SK 6000 bodypack transmitter.



CAUTION

Damage to the bodypack transmitter and/or rechargeable battery/battery compartment

If you touch the following contacts, they may become dirty or bent.

- Supply voltage contacts and bodypack transmitter contacts
- BA 61 rechargeable battery charging and data contacts
- B 61 battery compartment contacts
- ▷ Do not touch the BA 61 rechargeable battery contacts or the B 61 battery compartment contacts.





Inserting and removing the B 61 battery compartment

i We recommend using the BA 61 rechargeable battery instead of the B 61 battery compartment. You can find more information about this subject under “Rechargeable batteries and battery compartments”.

Before using the battery compartment, you must insert the batteries as shown in the figure.

- ▷ Please observe correct polarity when inserting the batteries.
- ▷ Use only high-quality AA batteries (e.g. lithium or alkaline manganese batteries) or high-quality NiMH rechargeable batteries in the B 61 battery compartment.

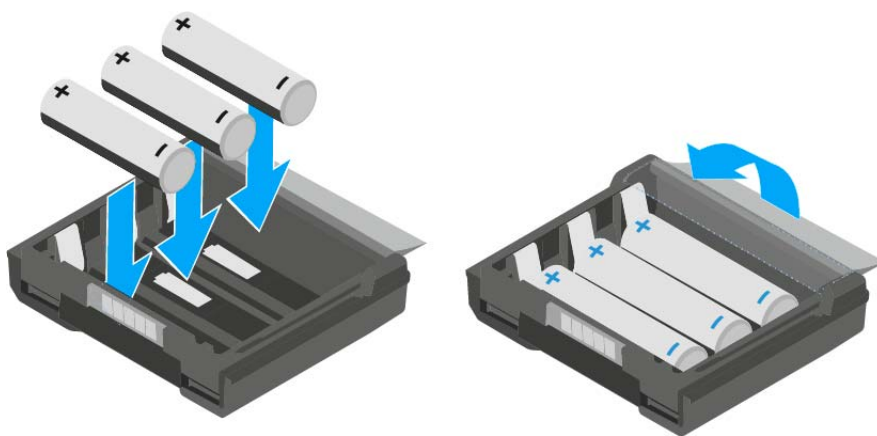

To insert the B 61 battery compartment into the SK 6000 bodypack transmitter:

- ▷ Insert the B 61 battery compartment into the SK 6000 bodypack transmitter as shown in the figure until it audibly clicks into place.





To remove the B 61 battery compartment from the SK 6000 bodypack transmitter:

- ▷ Press the two catches as shown in the figure and pull the B 61 battery compartment out of the SK 6000 bodypack transmitter.

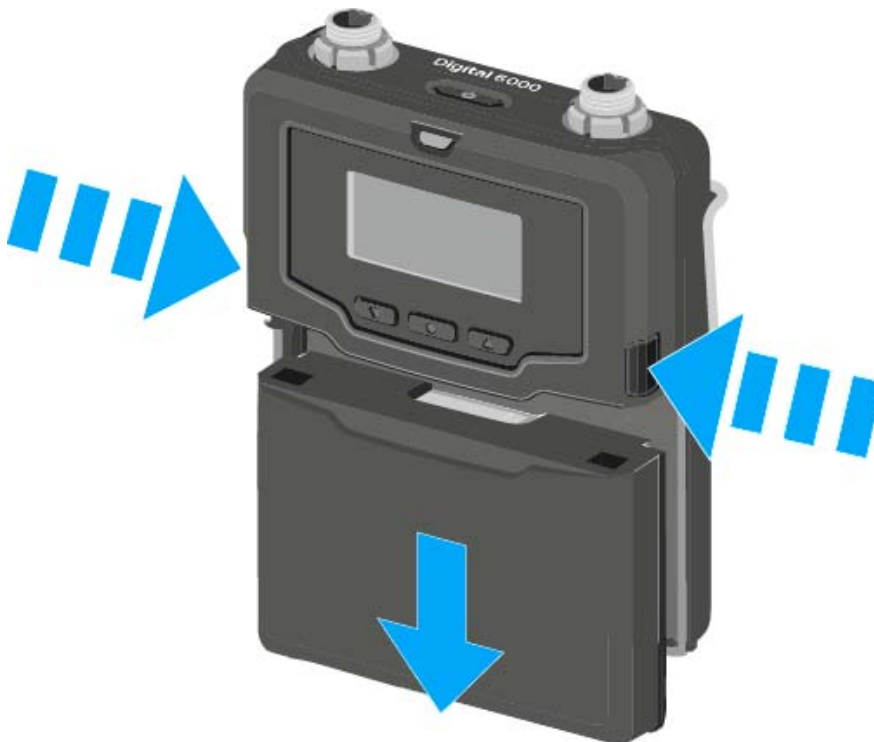

CAUTION

Damage to the bodypack transmitter and/or rechargeable battery/ battery compartment

If you touch the following contacts, they may become dirty or bent.

- Supply voltage contacts and bodypack transmitter contacts
- BA 61 rechargeable battery charging and data contacts
- B 61 battery compartment contacts
- ▷ Do not touch the BA 61 rechargeable battery contacts or the B 61 battery compartment contacts.





Mounting the antenna

To mount the supplied antenna:

- ▷ Connect the antenna to the SK 6000 bodypack transmitter antenna socket as shown in the figure.
- ▷ Tightly screw on the antenna coupling ring on the SK 6000 bodypack transmitter antenna socket.



i The antenna can be connected to the antenna socket very gently in only one direction. Do not use force to connect the antenna to the bodypack transmitter antenna socket.



Connecting a microphone to the SK 6000

We recommend using the following Lavalier microphones and headset microphones with the SK 6000 bodypack transmitter.

Microphone	Features	Article no.
MKE 1-4	Lavalier microphone, omni-directional	502167
MKE 2-4	Lavalier microphone, omni-directional	004736
MKE 40-4	Lavalier microphone, cardioid	003579
HSP 2	Headset microphone, omni-directional	009862
HSP 4	Headset microphone, cardioid	009864
SL Headmic 1-4	Headset microphone, omni-directional	506905

To connect a microphone to the bodypack transmitter:

- ▷ Use a 3-pin audio connector to connect the microphone cable to the SK 6000 bodypack transmitter audio socket as shown in the figure.
- ▷ Tightly screw on the microphone cable coupling ring on the audio socket thread of the SK 6000 bodypack transmitter.



i For more information about using the particular microphone, see the corresponding instruction manual for the microphone. You can find this instruction manual in the download section of the Sennheiser website under www.sennheiser.com/download.



Connecting an instrument or line source to the SK 6000

You can connect instruments or audio sources with a line level to the SK 6000 bodypack transmitter.

To do so, you require the Sennheiser CI 1-4 cable (6.3 mm (1/4") jack plug to 3-pin audio connector)

To connect an instrument or line source to bodypack transmitter:

- ▷ Connect the 3-pin audio connector of the CI 1-4 cable to the SK 6000 bodypack transmitter audio socket as shown in the figure.
- ▷ Tightly screw on the audio cable coupling ring on the audio socket thread of the SK 6000 bodypack transmitter.





Installing the L 6000 | LM 6060 | LM 6061

These sections contain detailed information about installing the L 6000.

You can find information about operating the L 6000 under “Using the L 6000”.



Connecting/disconnecting the L 6000 to/from the power supply system

To connect the L 6000 to the power supply system:

- Connect the mains cable IEC connector to the power socket on the rear side of the L 6000.
- Connect the mains cable plug into a suitable wall socket.

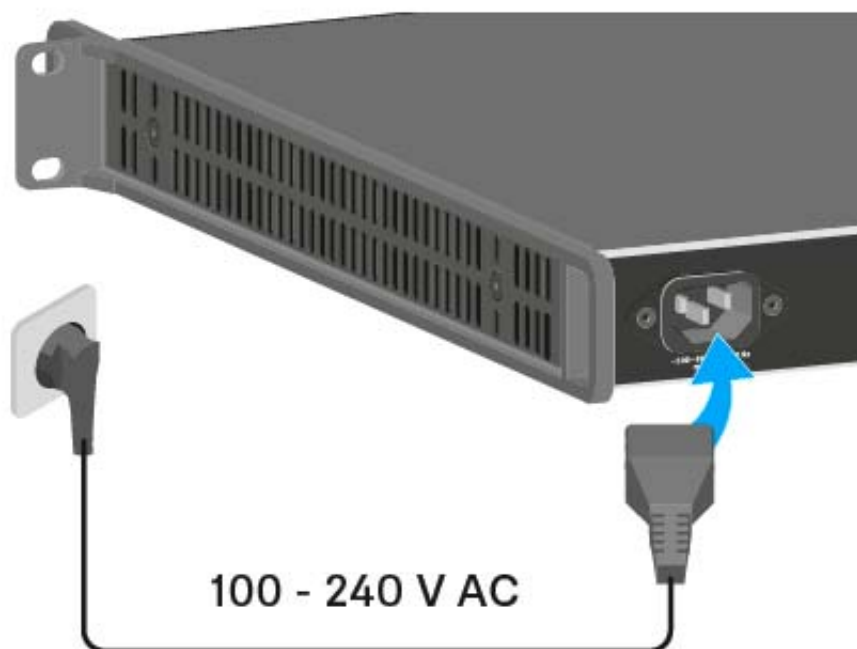

To completely disconnect the EM 6000 from the power supply system:

- Unplug the mains cable plug from the wall socket.
- Unplug the mains cable IEC connector from the power socket on the rear side of the EM 6000.



Connecting the L 6000 to a network

You can monitor and control one or more L 6000s via a network connection using **Sennheiser Wireless Systems Manager (WSM)** software.

The network does not have to be a homogeneous network including only chargers. You can integrate the L 6000 into your existing network infrastructure with any other types of devices.

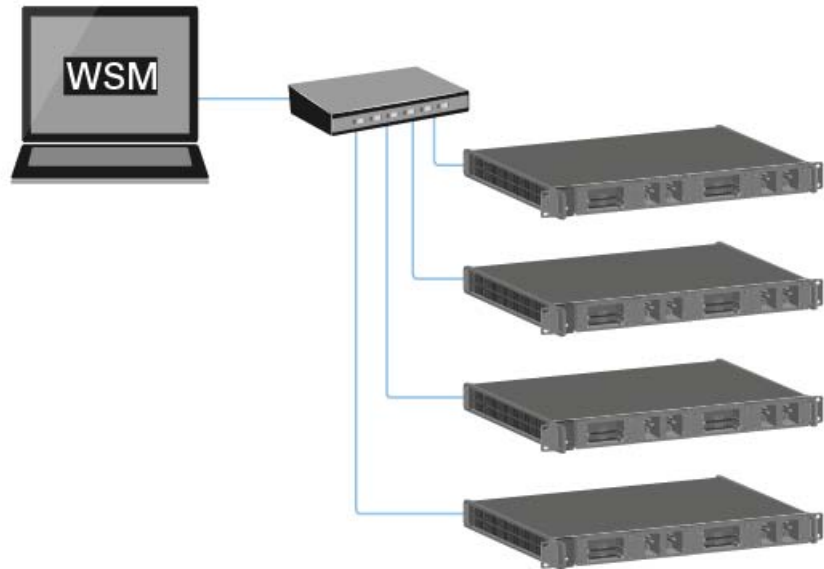

To connect the L 6000 to a network:

- ▷ Connect a network cable with an RJ-45 connector (Cat5 at minimum) to the **Ethernet** socket on the rear side of the L 6000.



i For more information about controlling devices via the Sennheiser Wireless Systems Manager (WSM) software, refer to the instruction manual for the software.



Installing the LM 6060 and LM 6061 charging modules in the L 6000

The following two charging modules are available for the L 6000 charger:

- **LM 6060** -> for charging the **BA 60** rechargeable battery



- **LM 6061** -> for charging the **BA 61** rechargeable battery



You can combine the LM 6060 and LM 6061 in any way in the L 6000 charger.



To install a charging module in the L 6000 charger:

- ▷ Completely disconnect the L 6000 charger from the power supply system. See “Connecting/disconnecting the L 6000 to/from the power supply system”.
- ▷ Unscrew one of the dummy caps on the L 6000.
To do so, you require a Torx 10 screwdriver.

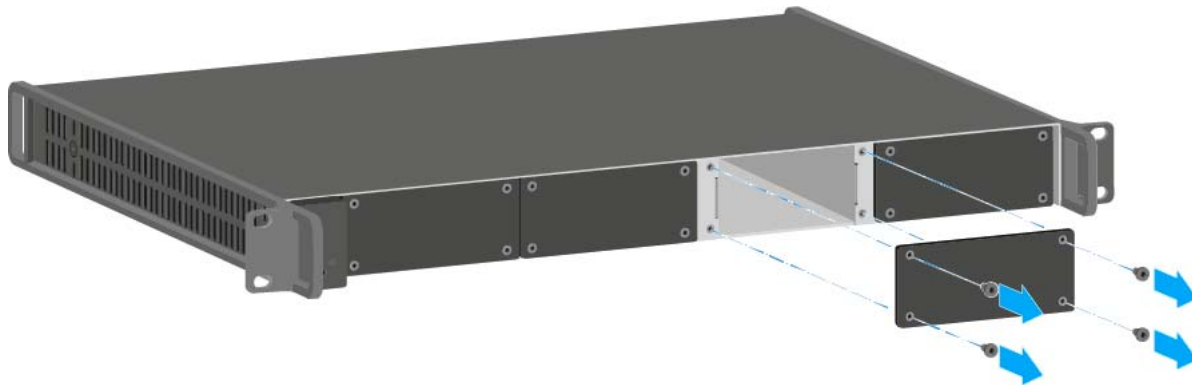

- ▷ Fully slide the charging module into the open charging slot as shown in the figure.
The charging module can be inserted into the L 6000 housing only in one direction. The Sennheiser lettering on the charging module must face upward.

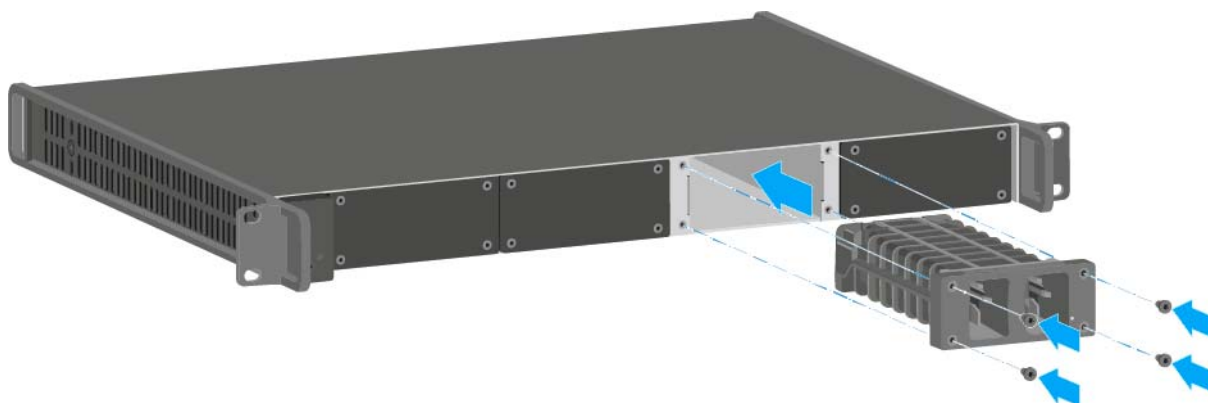

- ▷ Tightly screw on the charging module.



For more detailed information about charging the BA 60 and BA 61 rechargeable batteries, see “Charging rechargeable batteries”.



Installing the L 6000 in a rack

You can install the L 6000 charger in any conventional 19" rack. The rack mounting angles are already attached to the device.

Always observe the following information during rack mounting.

- ▷ Support the L 6000 charger after installation in the rack.
Due to the weight and depth of the device, there is a risk that it may break off in the rack and become damaged as a result.

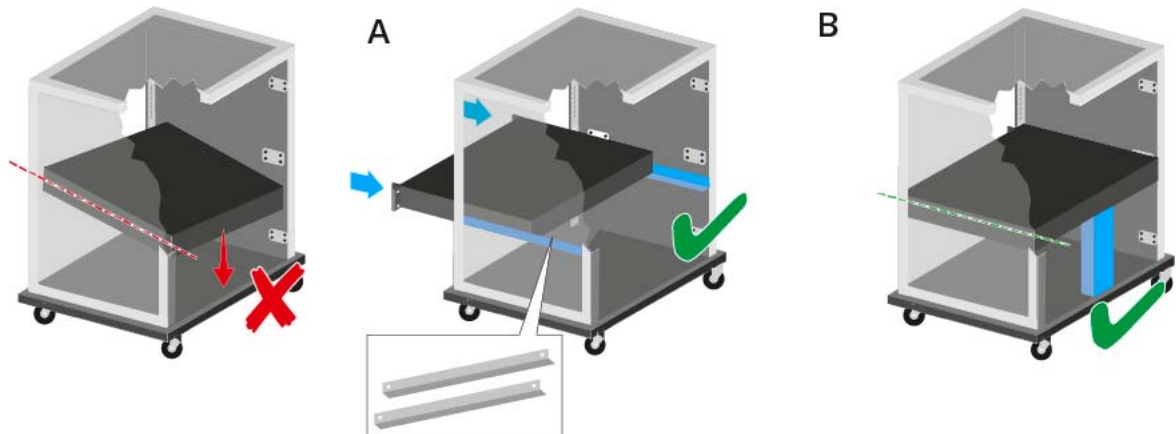

Version A:

- ▷ Use special rack mounting rails.
- ▷ The design of the rack used must be suitable for the installation of these mounting rails.

Version B:

- ▷ Use a suitable object to support the device on the rear side.
- ▷ Ensure that this object cannot become loose.

ATTENTION

Material damages caused by devices overheating

When there is insufficient ventilation, the devices mounted in the rack may overheat.

- ▷ Ensure that there is sufficient ventilation in the rack, particularly if several devices are installed. If necessary, install a fan in the rack.

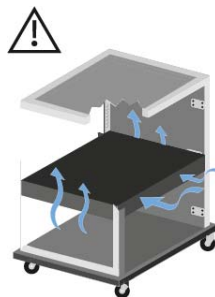



Using Digital 6000 series devices

You can find information about using **Digital 6000** series **devices** in the following sections.

- **EM 6000** 2-channel receiver >> “Using the EM 6000”
- **SKM 6000** handheld transmitter >> “Using the SKM 6000”
- **SK 6000** bodypack transmitter >> “Using the SK 6000”
- **L 6000** charger and **LM 6060**, **LM 6061** charging modules >> “Using the L 6000”

 You can find information about installing the products under “Installing Digital 6000 series devices”.

In the sections below, you can find important information about specific use cases.

- Establishing a **radio link** between the transmitter and receiver >> “Establishing a radio link”
- **Synchronizing** the receiver settings to the transmitter >> “Synchronizing devices”
- Using the **operating menu** of the receiver >> “Displays on the EM 6000 display panel”
- Information about **status messages** and **error messages** on the display >> “Status messages”



Using the EM 6000

These sections contain detailed information about operating the EM 6000. You can find information about installing the EM 6000 under “Installing the EM 6000”.



Operating elements on the front of the device

Product overview for the front of the EM 6000

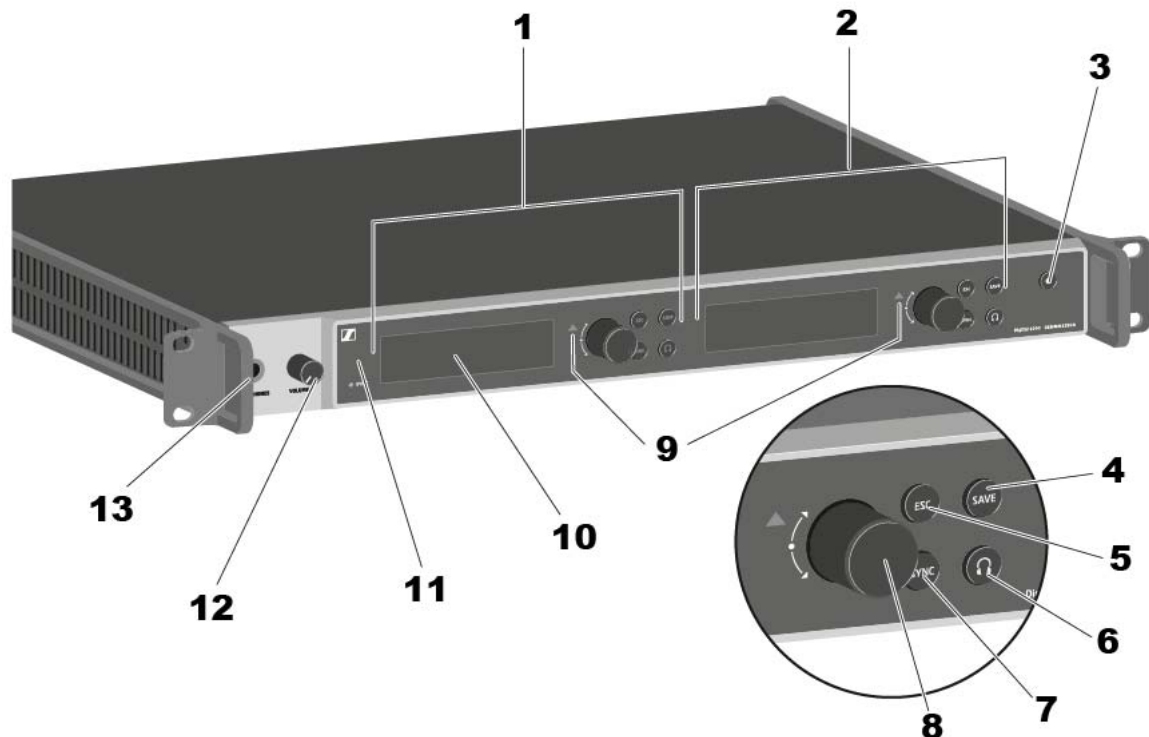

- 1** Displaying and using channel 1 (**CH 1**)
 - See “Displays on the EM 6000 display panel”
 - See “Buttons for navigating through the menu”
- 2** Displaying and using channel 2 (**CH 2**)
 - See “Displays on the EM 6000 display panel”
 - See “Buttons for navigating through the menu”
- 3** On/Off button
 - See “Switching the EM 6000 on and off”
- 4** **SAVE** button for saving settings in the menu (separate for CH 1 and CH 2)
 - See “Buttons for navigating through the menu”
- 5** **ESC** button for canceling an action in the menu (separate for CH 1 and CH 2)
 - See “Buttons for navigating through the menu”
- 6** Headphone button for listening in the particular channel via the **HEADPHONES** socket (**13**) (separate for CH 1 and CH 2)
 - See “Using the headphone output”
- 7** **SYNC** button for synchronizing the channel settings to a transmitter (separate for CH 1 and CH 2)
 - See “Synchronizing devices”
- 8** Jog dial for navigating through the menu (separate for CH 1 and CH 2)
 - See “Buttons for navigating through the menu”



- 9** Warning indicator for error messages (separate for CH 1 and CH 2)
 - See “Status messages”
- 10** Display (separate for CH 1 and CH 2)
 - See “Displays on the EM 6000 display panel”
- 11** Infra-red interface for the **SYNC** function
 - See “Synchronizing devices”
- 12** Volume control for the **HEADPHONES** headphone socket (**13**)
 - See “Using the headphone output”
- 13** **HEADPHONES** headphone socket
 - See “Using the headphone output”



Switching the EM 6000 on and off

To switch on the EM 6000:

- ▷ Connect the EM 6000 to the power supply system.
See “Connecting/disconnecting the EM 6000 to/from the power supply system”.
- ▷ Short-press the **On/Off** button.
The Sennheiser logo is temporarily displayed on the two displays. The two displays then show the home screen for the relevant channel.

To switch off the EM 6000:

- ▷ Hold down the **On/Off** button until the device switches off.



- i** Once the EM 6000 is connected to the power supply, the **On/Off** button lights up dimmed. If the booster voltage for antennas is activated in the menu, it is active already before you switch on the EM 6000.



Displays on the EM 6000 display panel

The EM 6000 has a separate display for each of the two channels **CH 1** and **CH 2**.

- In the displays, the home screens for both channels display the **channel-specific status information** such as the reception quality, battery life, audio level, and so on. See “Home screen”.
- The display also shows the **operating menu** for the two channels **CH 1** and **CH 2**, in which you can configure channel-specific settings. See “Setting options in the menu”.
- On the display for the channel **CH 1**, the **system settings** for the whole device are also displayed in the operating menu. See “System menu item”.



Buttons for navigating through the menu

To navigate through the EM 6000 operating menu, you require the following buttons.

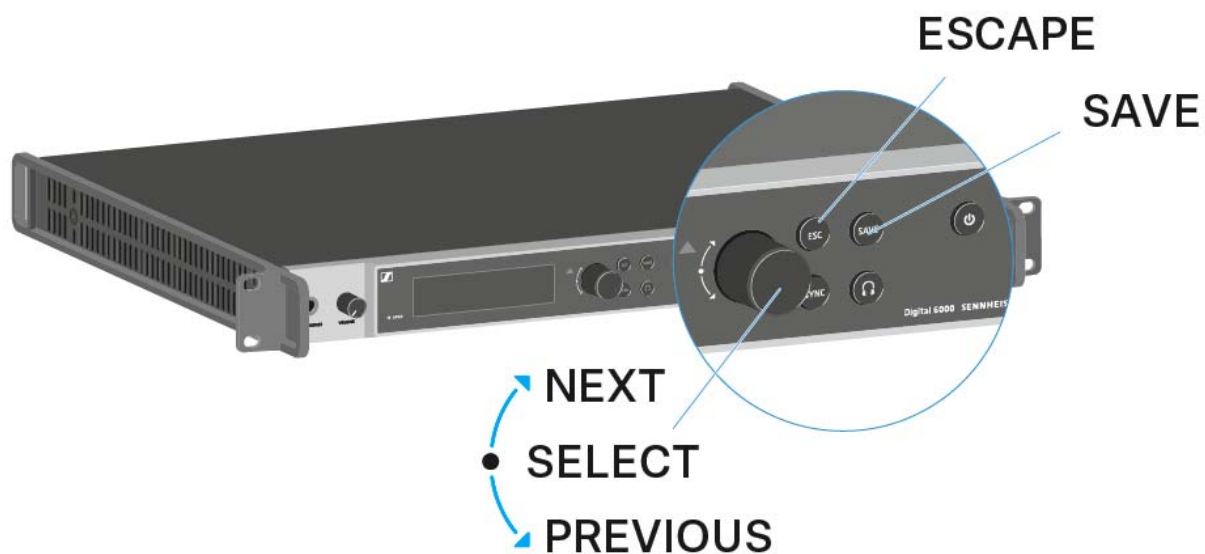

Turn the jog dial to the **right**: **NEXT**

- Display the next home screen
- Scroll down in the menu

Turn the jog dial to the **left**: **PREVIOUS**

- Display the previous home screen
- Scroll up in the menu

Press the jog dial: **SELECT**

- On the home screen: open the menu
- In the menu: open a menu item
- Within a menu item: go to the next selection

SAVE button

- Save a selection

ESC button

- Navigate back one level without saving

These buttons are located next to the two displays for the two **CH 1** and **CH 2** channels.



Home screen

After you switch on the receiver, the two displays initially show the Sennheiser logo. After a short time, the home screen is then displayed.



The home screen has 4 different views in total, which display different status information.

- ▷ Turn the jog dial to the right or left to switch between the individual home screens.



Home screen 1



The first home screen that is displayed as the initial view after the device switches on contains the following status information.

Display on the display panel	Meaning
------------------------------	---------

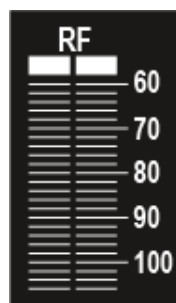
**RF = Radio Frequency**

Display of the radio link RF level for antenna A and antenna B.

i This display is shown on each home screen

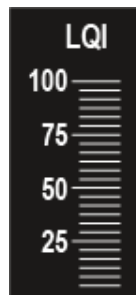
**LQI = Link Quality Indicator**

Shows the quality of the radio link. You can find more information under “Meaning of the Link Quality Indicator”.

i This display is shown on each home screen

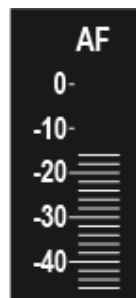
**AF = Audio Frequency**

Shows the transmitter audio input level.

This level is separate from the audio level that is output from the receiver.

i This display is shown on each home screen

LINK SKM

Name of the radio link

You can assign the radio link name yourself in the menu. See “Name menu item”.

470.200 MHz

Frequency

You can adjust the frequency in the menu. See “Frequency menu item”.



Remaining battery life

Shows the remaining battery life and the transmitter operating time.

The time is displayed only if the BA 60 and BA 61 rechargeable batteries are used.

For normal batteries, only the charge level of the batteries is displayed without time information.

 For more information about rechargeable batteries and batteries, see “Rechargeable batteries and battery compartments”.



AES 256 encryption

The AES icon is displayed if encryption has been activated for the channel. See “Encryption menu item”.



Home screen 2



The second home screen contains the following status information about the receiver settings.

Display on the display panel Meaning

B/Ch -	Bank/Channel
	Shows which channel is set in which frequency bank. See “Frequency menu item”.
AF Out -	AF Out
	Shows the receiver audio output level that is output via the audio outputs. See “AF Output menu item”.
Wordclock -	Wordclock
	Shows which wordclock setting is selected. See “Wordclock” under “System menu item”.
Booster -	Booster Feed
	Shows whether the booster feed for active antennas is activated. See “Booster Feed” under “System menu item”.



Home screen 3

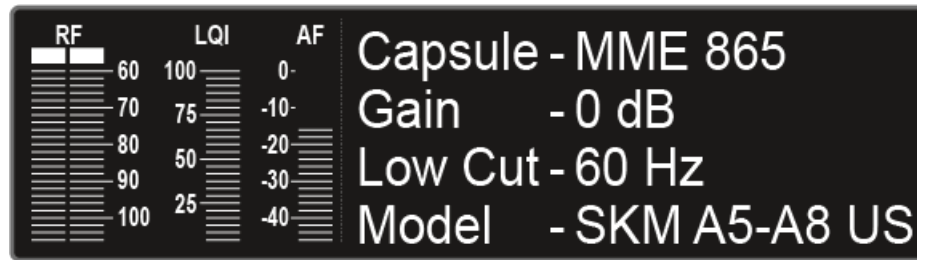

The third home screen contains the following status information about the transmitter settings.

Display on the display panel	Meaning
------------------------------	---------

Capsule -	<p>Capsule</p> <p>Shows the microphone module with which the handheld transmitter is equipped.</p> <p>Recommended microphone modules for the handheld transmitter: “Microphone modules”</p>
------------------	--

Gain -	<p>Gain</p> <p>Displays the gain setting for the transmitter.</p> <p>This setting can be configured in the transmitter menu. See “Operating the SKM 6000 menu” or “Operating the SK 6000 menu”.</p> <p>Alternatively, the gain setting can also be configured in the receiver and synchronized with the transmitter. See “Sync Settings menu item”.</p>
---------------	--

Low Cut -	<p>Low Cut</p> <p>Shows the low cut filter setting for the transmitter.</p> <p>This setting can be configured in the transmitter menu. See “Operating the SKM 6000 menu” or “Operating the SK 6000 menu”.</p> <p>Alternatively, the low cut setting can also be configured in the receiver and synchronized with the transmitter. See “Sync Settings menu item”.</p>
------------------	---

Model -	<p>Model</p> <p>Shows the transmitter product variant. See “SKM 6000 product variants” or “SK 6000 product variants”.</p>
----------------	--



Home screen 4

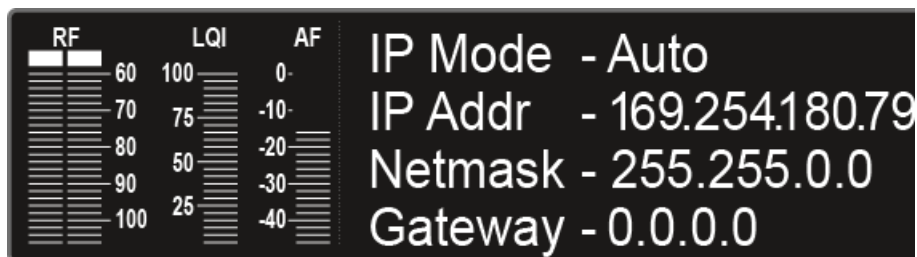

The fourth home screen contains the following status information about the receiver network settings.

Display on the display panel Meaning

IP Mode -	IP Mode Shows whether the IP address is assigned automatically or manually. See “Network” under “System menu item”.
IP Addr -	IP Address Shows the IP address of the receiver. See “Network” under “System menu item”.
Netmask -	Netmask Shows the netmask of the receiver. See “Network” under “System menu item”.
Gateway -	Gateway Shows the gateway of the receiver. See “Network” under “System menu item”.



Setting options in the menu

In the EM 6000 menu, you can configure the following settings.

Adjusting frequencies

- ▷ See “Frequency menu item”

Setting up user-defined frequency banks

- ▷ See “Bank Edit menu item”

Changing link names

- ▷ See “Name menu item”

Configuring settings that are transferred to the transmitter during a sync

- ▷ See “Sync Settings menu item”

Activating and deactivating encryption

- ▷ See “Encryption menu item”

Performing a frequency scan and automatic frequency setup

- ▷ See “Scan & Auto-Setup menu item”

Performing a walk test

- ▷ See “Walktest menu item”

Adjusting the output level of the receiver audio signal

- ▷ See “AF Output menu item”

Playing back a test tone

- ▷ See “Test Tone menu item”

Configuring different system settings

- Configuring wordclock
- Configuring network settings
- Changing device names
- Configuring Dante settings (only EM 6000 DANTE)
- Activating the power supply for an external antenna amplifier
- Changing the brightness of the display panel
- Activating the auto-setup function
- Displaying information about software and hardware
- Updating the firmware for the transmitters
- Resetting settings
- ▷ See “System menu item”



You can find an overview of the entire menu structure under “Menu structure”.



Menu structure

The figure shows the complete EM 6000 menu structure in an overview.

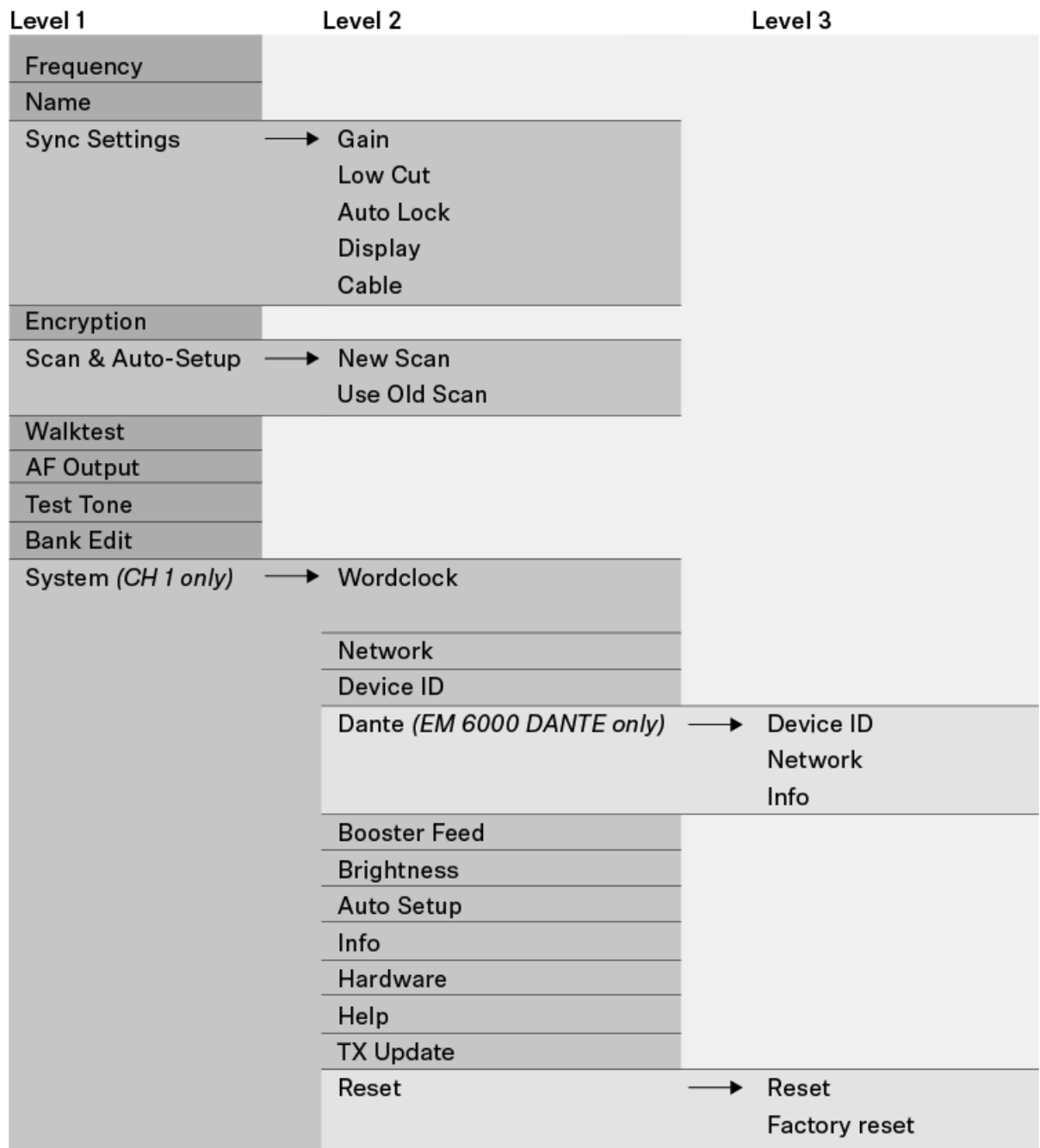



Frequency menu item

In the **Frequency** menu item, you can adjust the frequency for the channel in question.

You can select a frequency from the predefined frequency banks B1 to B6 (up to 65 channels per bank) or manually adjust the frequency.

You can also select frequencies from the user-defined frequency banks **U1** to **U6**. You can adjust these frequency banks in the **Bank Edit** menu item. See “Bank Edit menu item”.



You can find a detailed frequency table with all of the channels for banks B1 to B6 under “Frequency table”.

To open the **Frequency** menu item:

- ▷ On the home screen, press the jog dial to open the operating menu.
- ▷ Turn the jog dial until the **Frequency** menu item appears in the selection frame:

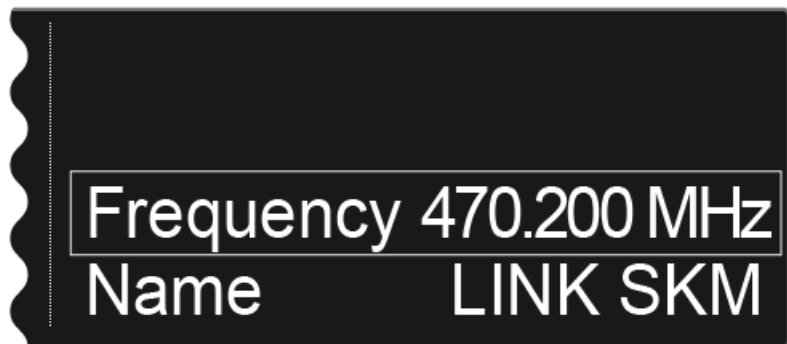

- ▷ Press the jog dial to open the menu.

The following view is displayed:

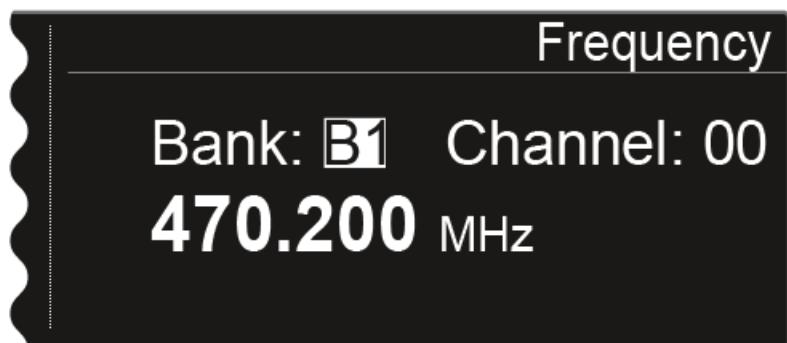

- ▷ Turn the jog dial to select a different frequency bank.
- ▷ Press the jog dial to go to the channel selection:

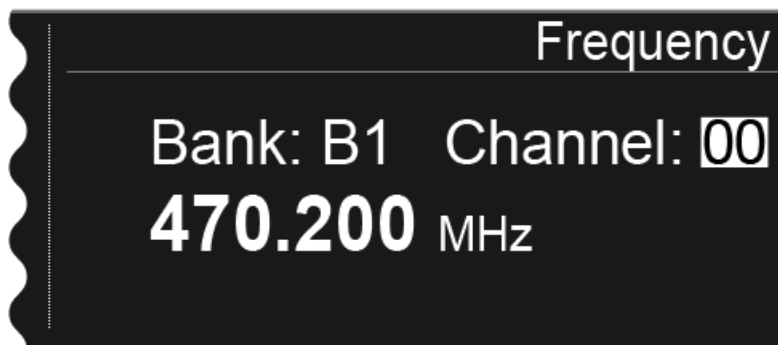

- ▷ Turn the jog dial to set a different channel.
- ▷ Press the **SAVE** button to confirm the selection of the bank and channel.

or

- ▷ Press the jog dial to go to the manual frequency setting:

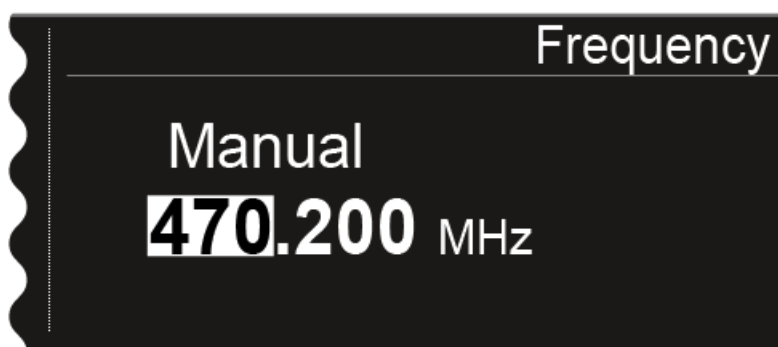

- ▷ Turn the jog dial to set the desired frequency.
- ▷ Press the **SAVE** button to save the set frequency.



Name menu item

In the **Name** menu item, you can define the name of the link for the channel in question.

i This name is the name of the radio link between the transmitter and receiver. In the network settings, you can enter the receiver name as it is displayed in a network: see “Device ID” under “System menu item”.

To open the **Name** menu item:

- ▷ On the home screen, press the jog dial to open the operating menu.
- ▷ Turn the jog dial until the **Name** menu item appears in the selection frame:

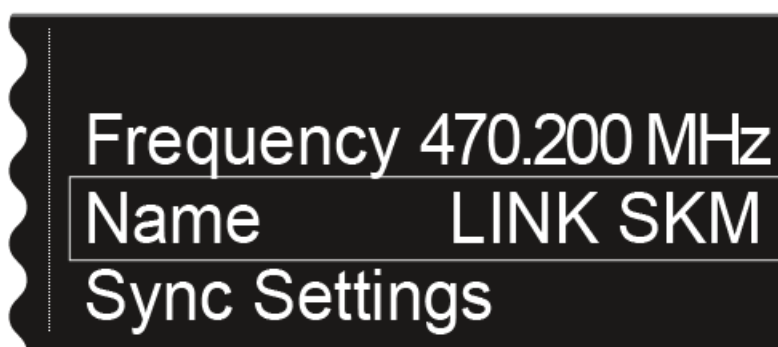

- ▷ Press the jog dial to open the menu.

The following view is displayed:

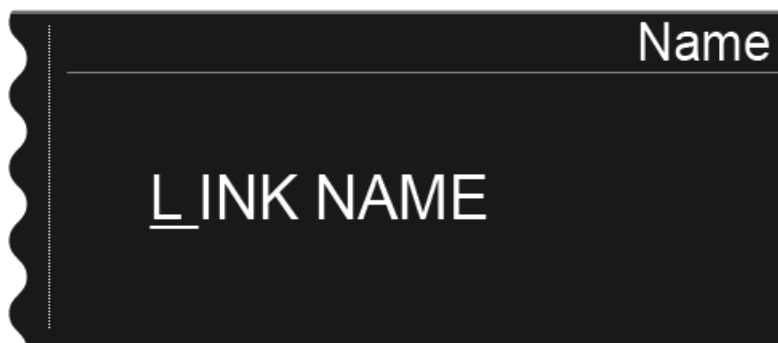

To enter the desired link name:

- ▷ Turn the jog dial to select the desired character.
- ▷ Press the jog dial to go to the next position.
- ▷ Press the **SAVE** button to save the set name.



Sync Settings menu item

In the Sync Settings menu item, you can choose which settings for the transmitter you want to transfer from the receiver to the transmitter during the synchronization.

All of the settings can also be set separately in the menu on the transmitter. However, you can simply use the **Sync** function to configure these settings via the receiver.

i For more information about the **Sync** function, see “Synchronizing devices”.

The following settings can be transferred:

Option	Possible setting
Gain	Gain setting for the transmitter, from -6 to 60 dB
Low Cut	Low cut filter, from 30 Hz to 120 Hz
Auto Lock	Activate or deactivate the lock-off on the transmitter
Display panel	Display on the home screen of the transmitter display panel <ul style="list-style-type: none"> • Name of the link • Frequency • Preset
Cable	Cable emulator in 4 steps <ul style="list-style-type: none"> • Line • Type 1 • Type 2 • Type 3

i If you do not want to transfer all of these values to the transmitter, you can also set the **no sync** value for each option. The option in question is then not included in the synchronization.



To open the **Sync Settings** menu item:

- ▷ On the home screen, press the jog dial to open the operating menu.
- ▷ Turn the jog dial until the **Sync Settings** menu item appears in the selection frame:

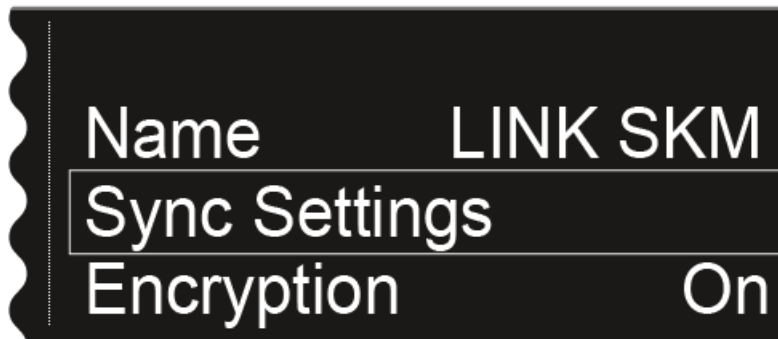

- ▷ Press the jog dial to open the menu.

The following view is displayed:

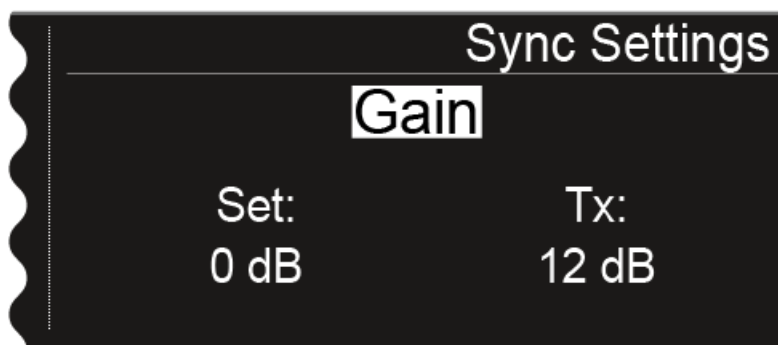

The top line displays the option that is currently selected (Gain, Low Cut, Auto Lock, Display, Cable).

The **Set** value shows the setting that you can select for the synchronization in this menu item. The **Tx** value shows the value that is currently set on the transmitter.



You can perform the following actions:

- ▷ Press the jog dial to choose between the following options:

Switch between the options

Set the **Set** value

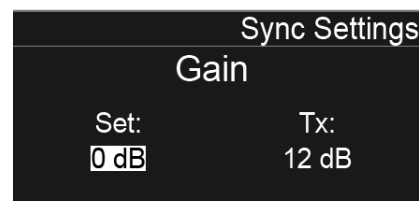
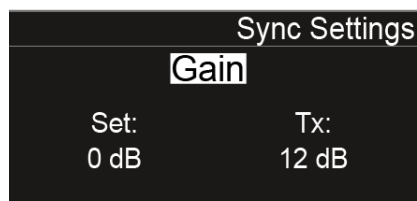

- ▷ Turn the jog dial to choose between the **Gain**, **Low Cut**, **Auto Lock**, **Display**, and **Cable** options.
- ▷ Turn the jog dial to set the desired value.

- ▷ Press the **SAVE** button to save the selected settings.

Gain

Adjusting the gain settings for the transmitter

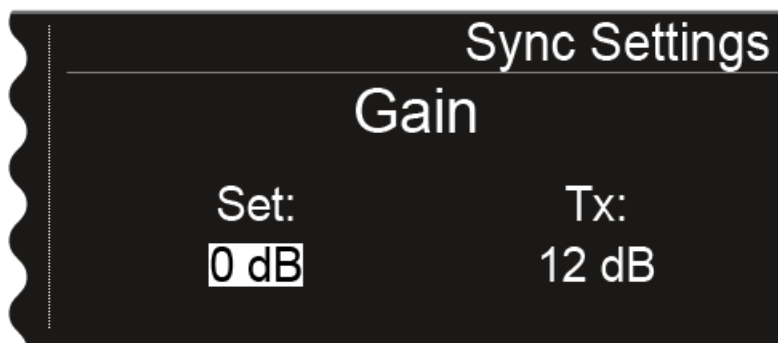

You can configure the following settings for the **Set** value:

- **-6 dB** to **60 dB** in increments of 3 dB
- **no sync**, so that this value is not synchronized



Low Cut

Adjusting the low cut filter for the transmitter



You can configure the following settings for the **Set** value:

- **30 Hz to 120 Hz** in increments of 30 Hz.
- **no sync**, so that this value is not synchronized

Auto Lock

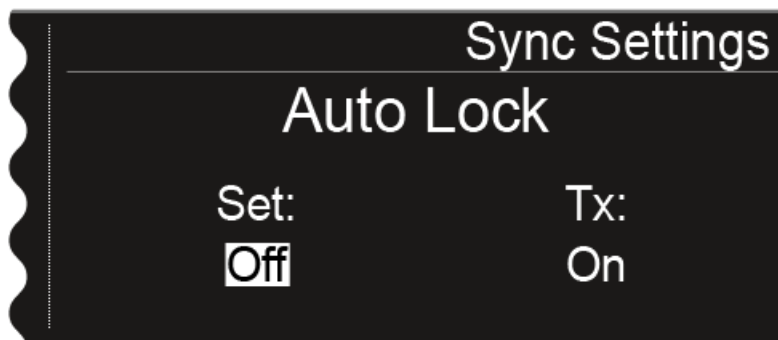

You can configure the following settings for the **Set** value:

- **On** or **Off**
- **no sync**, so that this value is not synchronized



Display panel

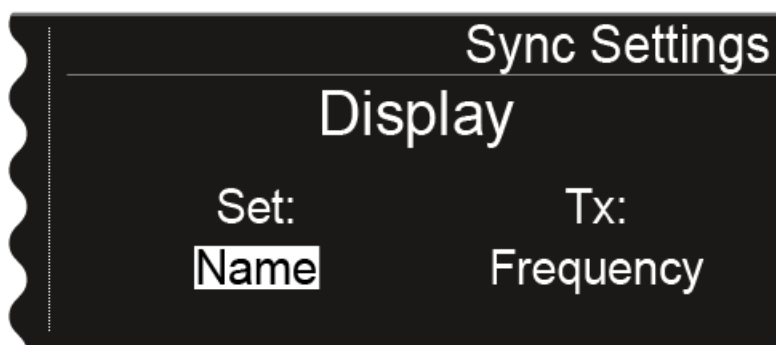

You can configure the following settings for the **Set** value:

- **Name, Frequency, or Preset**
- **no sync**, so that this value is not synchronized

Cable

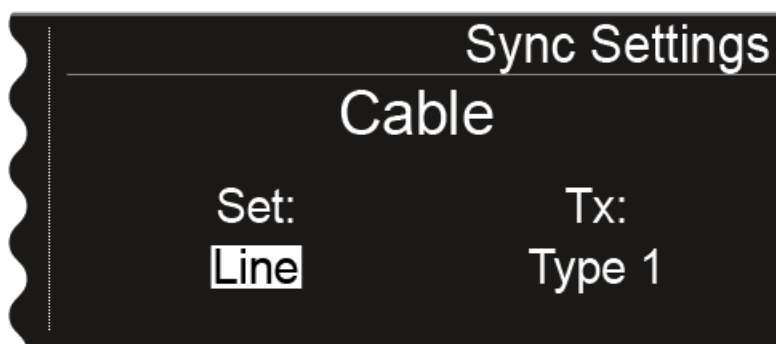

The **Cable** function is a cable emulator that you can in 3 stages (**Type 1**, **Type 2**, and **Type 3**). Cable emulation is switched off with the **Line** option.

You can configure the following settings for the **Set** value:

- **Line**
- **Type 1, Type 2, or Type 3**
- **no sync**, so that this value is not synchronized



Encryption menu item

You can secure the radio link between the transmitter and receiver using AES 256 encryption.

To open the **Encryption** menu item:

- ▷ On the home screen, press the jog dial to open the operating menu.
- ▷ Turn the jog dial until the **Encryption** menu item appears in the selection frame:



- ▷ Press the jog dial to open the menu.

The following view is displayed:



- ▷ Turn the jog dial to choose between the **On** and **Off** values.





- ▷ Set the desired value.
- ▷ Press the **SAVE** button to save your selection.

If you have activated encryption, you must first transfer this setting to the transmitter using the **Sync** function. See “Synchronizing devices”.

Encryption cannot be activated on the transmitter itself.



Scan & Auto-Setup menu item

The EM 6000 lets you scan the frequency spectrum and display all of the free frequencies in the selected frequency range. The automatic frequency setup can be used to distribute the free frequencies to all of the EM 6000 devices available in the network automatically.

You can select the frequency range to be scanned from the predefined frequencies **B1** to **B6** or from the user-defined frequency banks **U1** to **U6** or set them manually.

The **Auto Setup** function also helps you to establish an equidistant frequency grid via frequency bank E, which is provided to do so. For more information about the equidistant frequency grid, see “Equidistant frequency grid”.

Alternatively, you can use the Sennheiser Wireless Systems Manager (WSM) software.

Performing a frequency scan and automatic frequency setup

1. Activate the **Auto Setup** function in the **System** menu item for all of the EM 6000 devices in the network that you want to include in the automatic frequency setup. See “Auto Setup” under “System menu item”.
If the function is not activated for an EM 6000, the automatic frequency setup cannot be performed for this EM 6000.
2. Open the **Scan & Auto-Setup** menu item and start the automatic frequency setup.

 The EM 6000 on which you perform the **Auto-Setup** function is defined as the master device in the network. The other devices adopt the slave function.



Switch off all transmitters before you perform the scan. If transmitters are still switched on, they are detected as unavailable frequencies and the frequencies that are actually available cannot then be used.



To open the **Scan & Auto-Setup** menu item:

- ▷ On the home screen, press the jog dial to open the operating menu.
- ▷ Turn the jog dial until the **Scan & Auto-Setup** menu item appears in the selection frame:



- ▷ Press the jog dial to open the menu.

The following view is displayed:

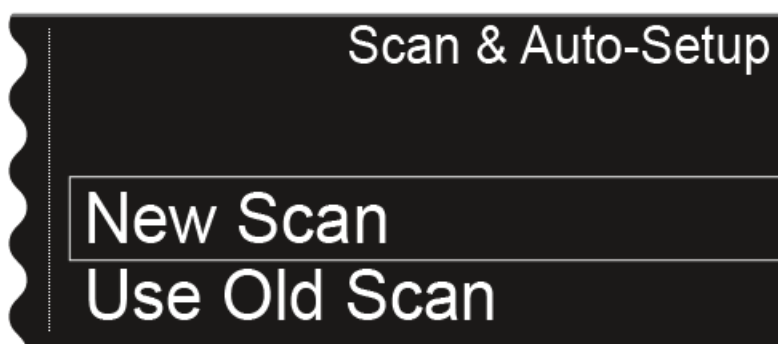

- ▷ Choose **New Scan** to perform a complete scan of the environment.
- ▷ Choose **Use Old Scan** if you have already performed a scan and you want to add only a small number of new devices to the existing production environment.



Step 1a: New Scan

After you choose **New Scan**, the following view is displayed.

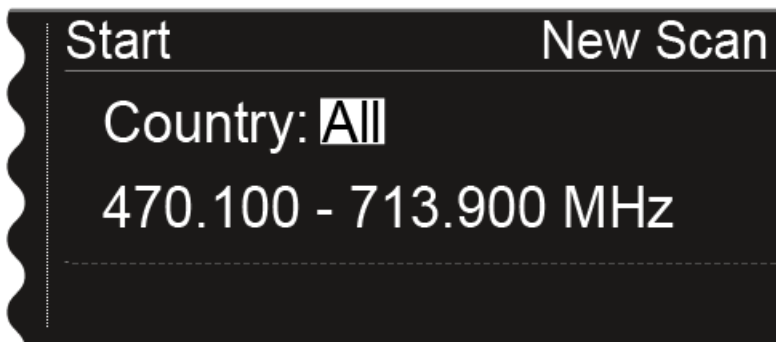

- ▷ Turn the jog dial to select the frequency range to be scanned:
 - Choose **All** for the **Country** setting to scan the entire EM 6000 frequency range.
 - Choose **USA**, **Japan**, **China**, or **Korea** if you use specific frequency variants for the transmitters so that only the frequency range that is actually used is scanned.

or

- ▷ Press the jog dial to set the frequency range to be scanned manually.

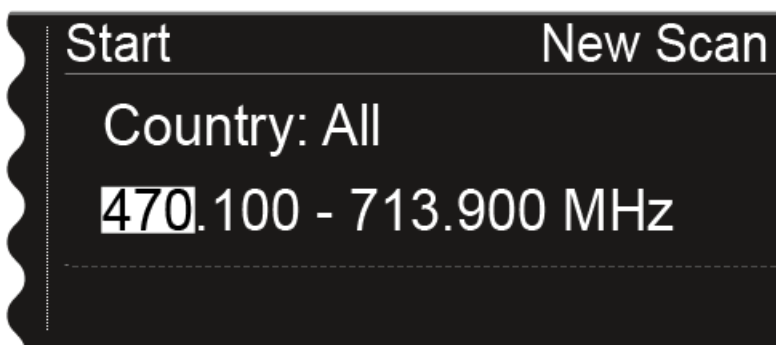

You can adjust the value by turning the jog dial. Press the jog dial to move back and forth between the individual points of the frequencies.



- After you set the frequency range to be scanned, press the jog dial until the **Start** option in the top left of the selection is displayed with a white background.

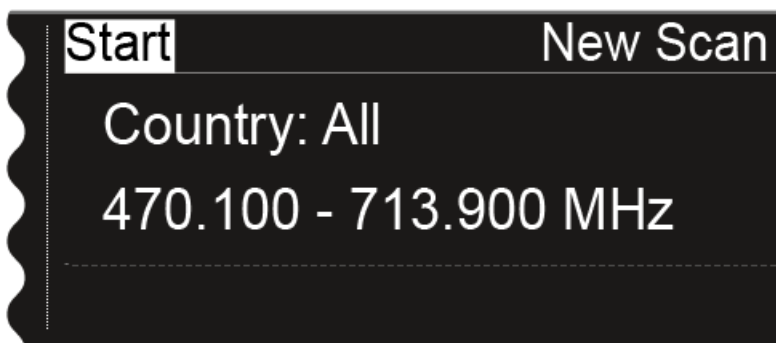

- Press the jog dial to start the frequency scan.
The scan is performed. The progress is displayed in % on the display.

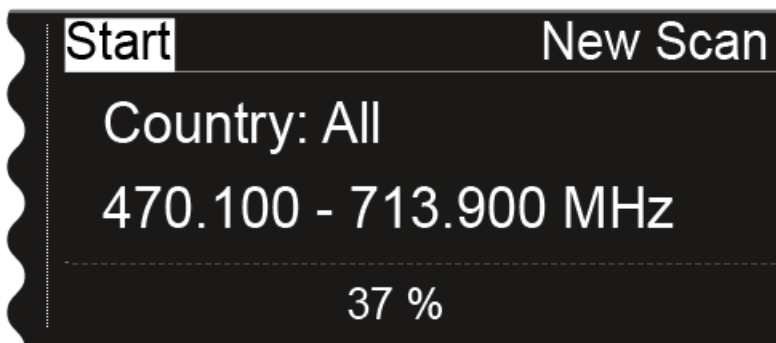

Once the scan is performed, the result is displayed. All of the free frequencies in the selected range are displayed.

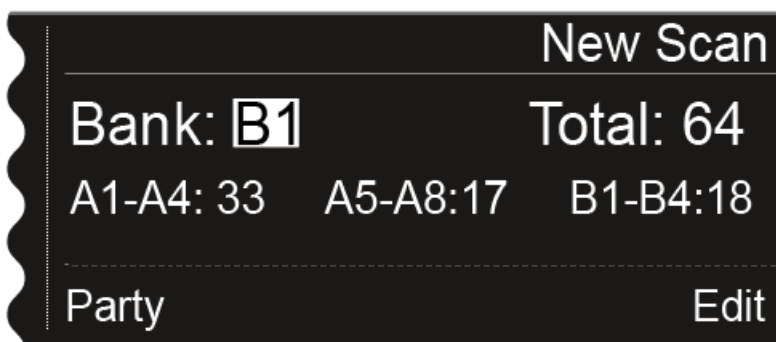

- Turn the jog dial to scroll through the frequency banks and display the number of free frequencies available for each bank.

Step 1b: Use Old Scan



If you choose the Use Old Scan option, the result of the last scan is displayed.

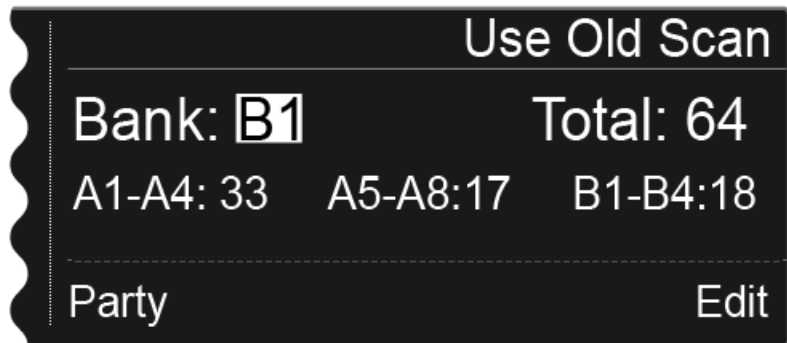

- ▷ Turn the jog dial to scroll through the frequency banks and display the number of free frequencies available for each bank.
The frequency bank that you select here is used for the automatic frequency setup in step 3.
- ▷ Choose **frequency bank E** here if you want to set up an **equidistant frequency grid**. See “Equidistant frequency grid”.

Step 2: Editing displayed frequencies

If you want specific frequencies not to be used in the auto setup, you can skip them using the **Edit** function.

- ▷ Press the jog dial.
The **Party** option is displayed in the bottom left with a white background.
- ▷ Turn the jog dial to the right.
The **Edit** function is displayed in the bottom right in a white background.

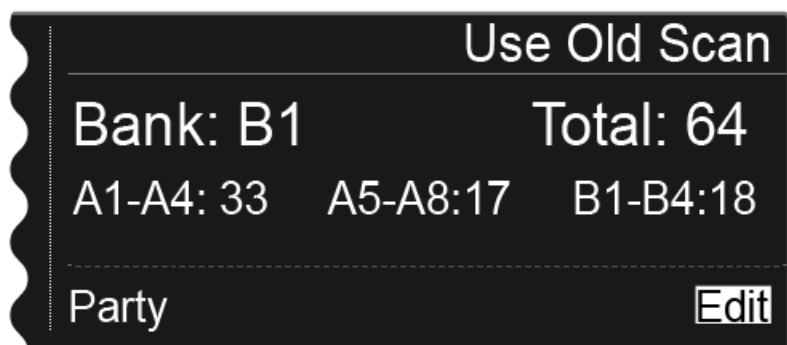

- ▷ Press the jog dial to open the **Edit** function.
The following view is displayed:

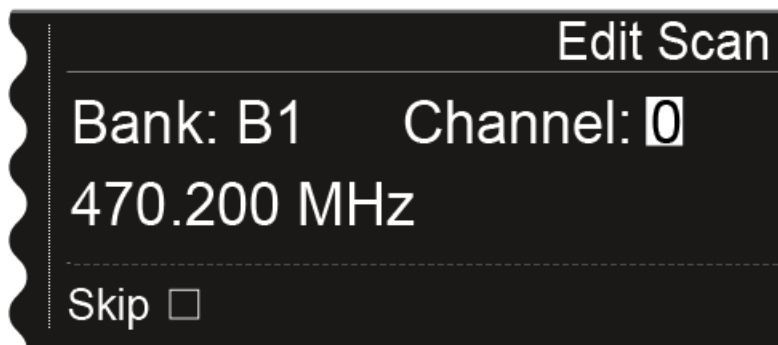

- ▷ Press the jog dial to search for the channel that you want to skip during the automatic frequency setup.
- ▷ Press the jog dial
- ▷ The checkbox for the **Skip** option is highlighted in white.

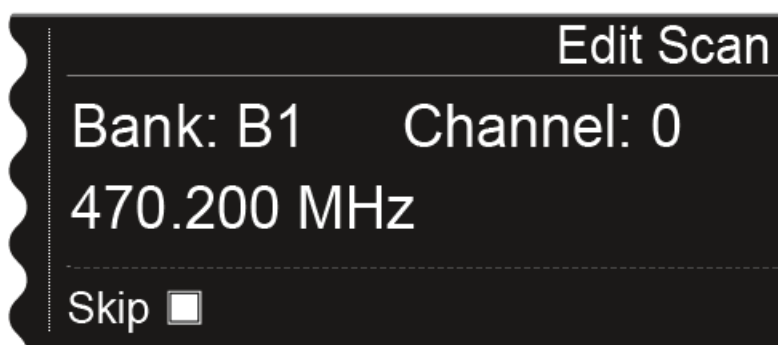

Turn the jog dial to activate the Skip option for the selected channel.

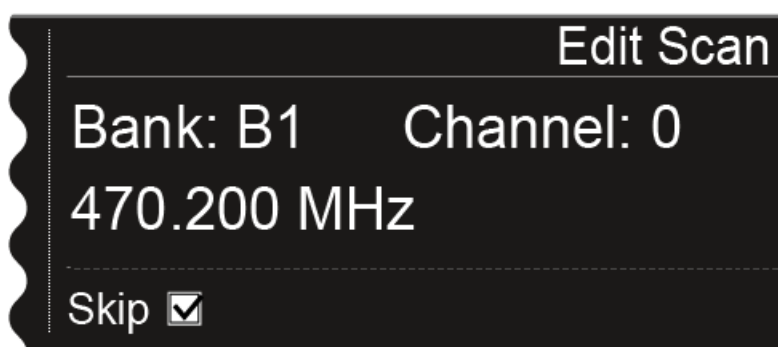

- ▷ Press the jog dial to select an additional channel to skip.
- Or
- ▷ Press the **SAVE** button to save the setting.
You can press the **ESC** button to cancel the function without saving.



Step 3: Starting the automatic frequency setup

If you have performed the scan and edited the frequencies, you can start the automatic frequency setup.

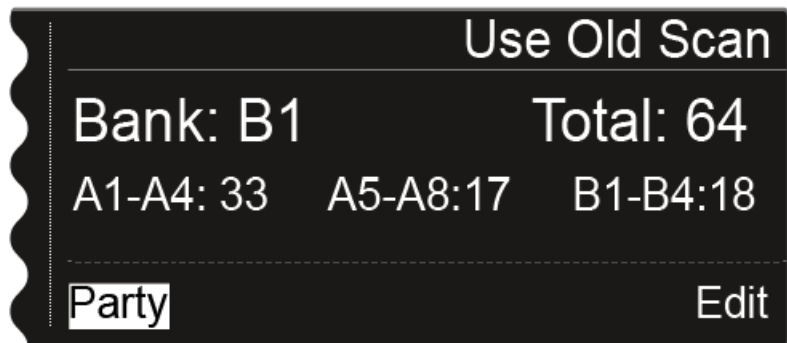

On the display, the **Party** option must be highlighted in white.

- ▷ Press the jog dial to start the automatic frequency setup.
The setup is performed for all receivers that are available in the network. Note that the **Auto-Setup** option in the **System** menu item must be activated for all of the receivers.

After the setup is performed, the following message is displayed.



This message is displayed on all of the displays of all of the receiver channels.

- ▷ Synchronize all of the channels and the corresponding transmitters using the **Sync** function.
For information about the **Sync** function, see “Synchronizing devices”.

i If you press the ESC button for a channel, the sync is canceled for both channels of the particular EM 6000 unit. However, if you press the ESC button for the channel in which you started the auto-setup function, the sync is canceled for all of the channels in the network. The EM 6000 on which you perform the auto-setup function is defined as the master device in the network. The other devices adopt the slave function.



Walktest menu item

Once you have set up and installed all of the receivers and transmitters for your event, we recommend performing a walk test. This lets you check whether sufficient reception strength is available throughout the entire area used.

Start the walktest function in this menu item and then walk the entire area with one transmitter. The results of the walk test give you information about the reception quality.

To open the **Walktest** menu item:

- ▷ On the home screen, press the jog dial to open the operating menu.
- ▷ Turn the jog dial until the **Walktest** menu item appears in the selection frame:

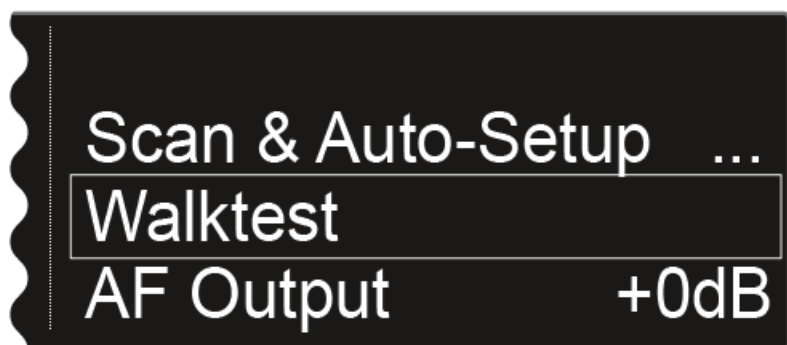

- ▷ Press the jog dial to open the menu.

The following view is displayed:

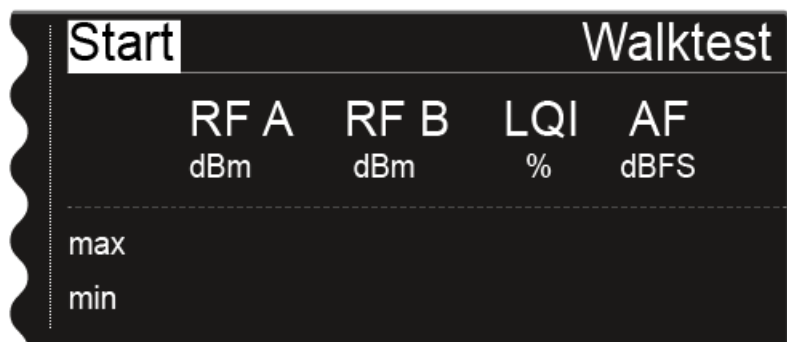

The **Start** option in the top left of the display is already highlighted for selection.

- ▷ Press the jog dial to start the walk test.
- ▷ Walk the entire area on which you want to operate the system with the transmitter.



The following values are recorded on the display:

RF A	Reception from antenna A in dBm
RF B	Reception from antenna B in dBm
LQI	Connection quality as a % See also “Meaning of the Link Quality Indicator”
AF	Transmitter audio frequency in dBFS

	Stop	Walktest			
		RF A	RF B	LQI	AF
		dBm	dBm	%	dBFS
max		-24	-28	100	-69
min		-61	-58	100	-101

During the walk test, the Stop option in the top left of the display is highlighted as the selection.

- ▷ Press the jog dial to finish the walk test when you are ready.



AF Output menu item

In the AF Output menu item, you can set the audio level that is output via the receiver audio outputs.

To open the **AF Output** menu item:

- ▷ On the home screen, press the jog dial to open the operating menu.
- ▷ Turn the jog dial until the **AF Output** menu item appears in the selection frame:

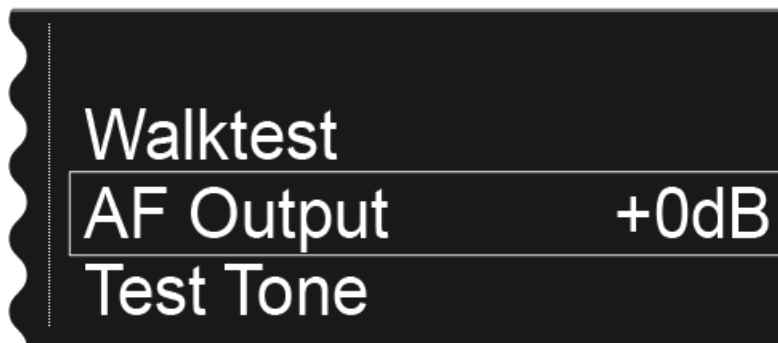

- ▷ Press the jog dial to open the menu.

The following view is displayed:



- ▷ Turn the jog dial to set the desired value between **-10 dB** and **+18 dB**.
- ▷ Press the **SAVE** button to save the set value.



Test Tone menu item

The EM 6000 provides an option for generating a test tone. You can use it, for example, to check the audio output of the device or level out channels on the mixing console.

To open the **Test Tone** menu item:

- ▷ On the home screen, press the jog dial to open the operating menu.
- ▷ Turn the jog dial until the **Test Tone** menu item appears in the selection frame:

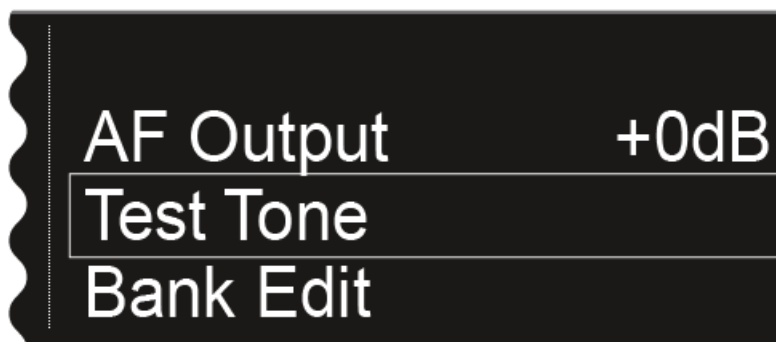

- ▷ Press the jog dial to open the menu.

The following view is displayed:

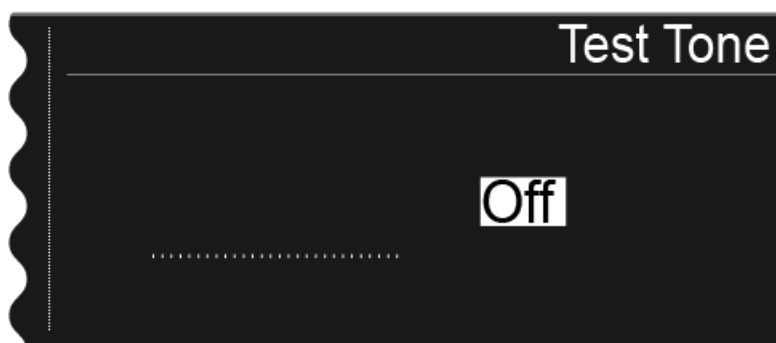

- ▷ Turn the jog dial to set the volume of the test tone.
You can set the volume of the test tone between -60 dB and 0 dB.



i While the test tone is played back, the transmitter audio signal is muted.



Bank Edit menu item

In addition to the predefined frequency banks **B1** to **B6**, you can assign frequencies to the user-defined frequency banks **U1** to **U6** yourself.

To open the **Bank Edit** menu item:

- ▷ On the home screen, press the jog dial to open the operating menu.
- ▷ Turn the jog dial until the **Bank Edit** menu item appears in the selection frame:



- ▷ Press the jog dial to open the menu.

The following view is displayed:

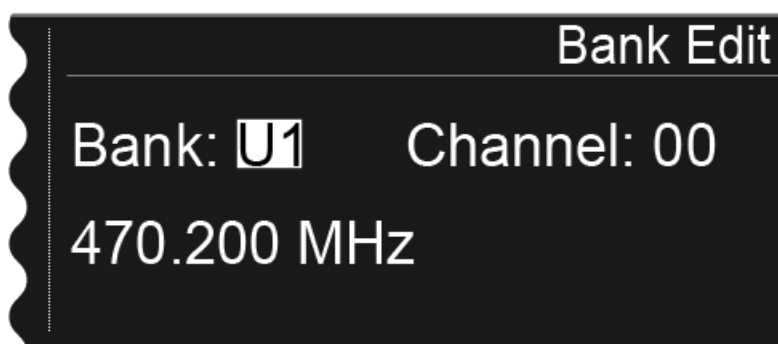

- ▷ Turn the jog dial to select the desired frequency bank (from U1 to U6).
- ▷ Press the jog dial to switch to the channel selection.

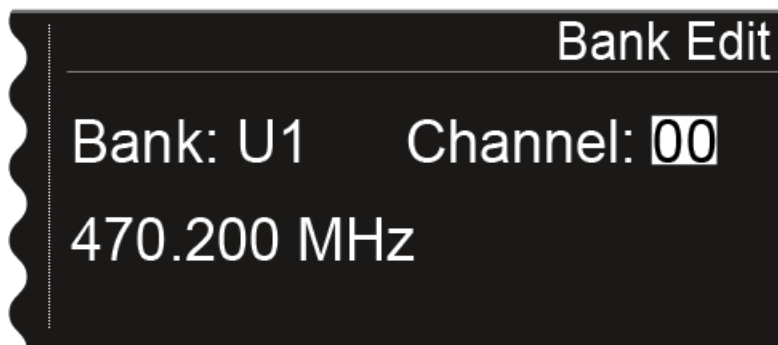

- ▷ Turn the jog dial to select the desired channel (from 00 to 99).
- ▷ Press the jog dial to switch to the frequency selection.

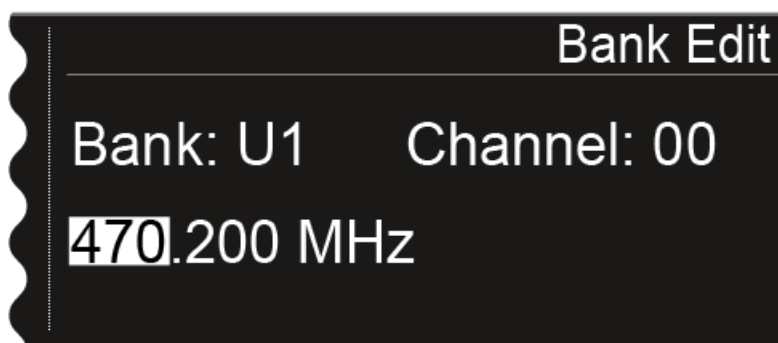

- ▷ Turn the jog dial to set the desired frequency for the selected bank and selected channel.
- ▷ Press the **SAVE** button to save the setting.



System menu item

In the System menu item, you can configure all of the cross-system settings. The System menu item is located in the menu of the channel CH 1.

To open the **System** menu item:

- ▷ On the home screen, press the jog dial to open the operating menu.
- ▷ Turn the jog dial until the **System** menu item appears in the selection frame:

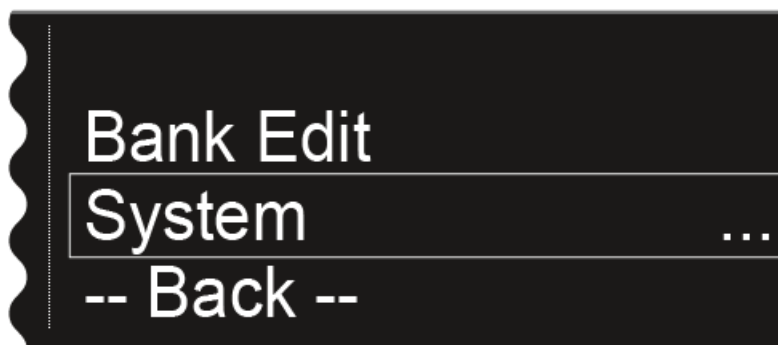

- ▷ Press the jog dial to open the menu.



Wordclock

In this menu item, you can configure the settings for the word clock.

To open the **Wordclock** menu item:

- ▷ Turn the jog dial in the **System** menu item until the **Wordclock** menu item appears in the selection frame.
- ▷ Press the jog dial to open the menu.

The display shows you the option that is currently selected.

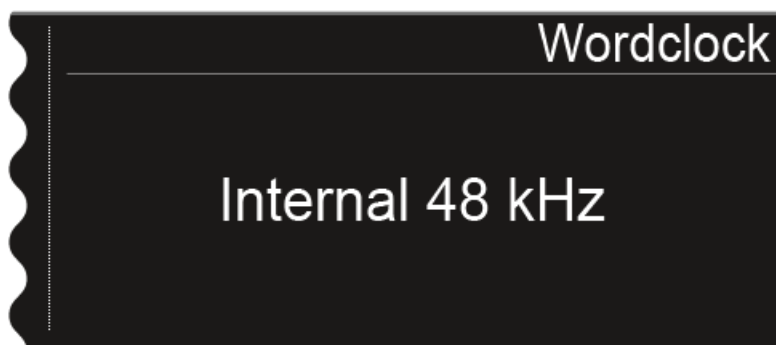

- ▷ Turn the jog dial to choose between the following options:
 - **Internal 48 kHz:** Choose this option if you want to use the internal word clock with a clock rate of 48 kHz.
 - **Internal 96 kHz:** Choose this option if you want to use the internal word clock with a clock rate of 96 kHz.
 - **External BNC:** Choose this option if you use an external word clock that is connected via the Wordclock In BNC input. See “Connecting the word clock”.
 - **External Dante:** Choose this option if you use an external word clock that is connected via the Dante interface. This option is available only with the EM 6000 DANTE.
- ▷ Press the **SAVE** button to save the setting.

i For more information about the word clock, see “Word clock scenarios for digital audio (AES3 and Dante™)”.



Network

In this menu item, you can configure the settings for the network connection.

To open the **Network** menu item:

- ▷ Turn the jog dial in the **System** menu item until the **Network** menu item appears in the selection frame.
- ▷ Press the jog dial to open the menu.
The display shows you the option that is currently selected.
- ▷ Turn the jog dial to choose between the following options:
 - **IP Mode Auto**: The network configuration is performed automatically.



- **IP Mode mDNS**: If you use mDNS for device identification on the network, you can manually set the IP address, netmask, and gateway.

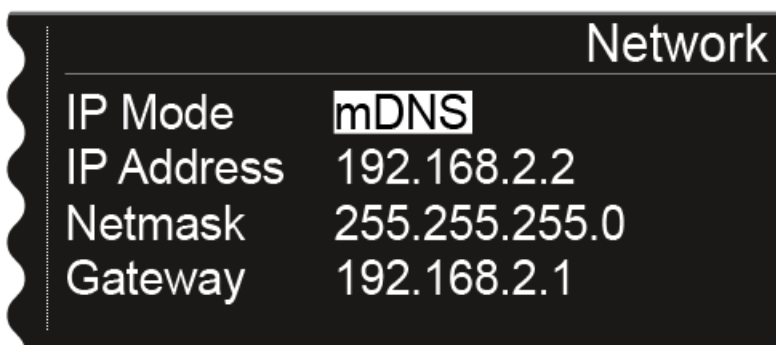

- **IP Mode Manual**: You can manually set the IP address, netmask, and gateway.



Network	
IP Mode	Manual
IP Address	192.168.2.2
Netmask	255.255.255.0
Gateway	192.168.2.1

To configure the settings in **IP Mode Manual** and **IP Mode mDNS**:

- ▷ Press the jog dial to switch between the individual network configuration items.
- ▷ Turn the jog dial to set the value.

Network	
IP Mode	Manual
IP Address	192 .168.2.2
Netmask	255.255.255.0
Gateway	192.168.2.1

- ▷ Press the **SAVE** button to save the settings.



Device ID

You can enter the name of the device in this menu item. This name is displayed for this EM 6000 in the network.

To open the **Device ID** menu item:

- ▷ Turn the jog dial in the **System** menu item until the **Device ID** menu item appears in the selection frame.
- ▷ Press the jog dial to open the menu.

The following view is shown on the display.

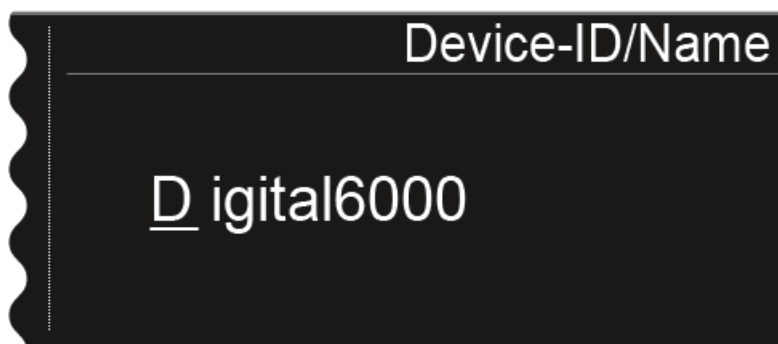

To enter the desired device name:

- ▷ Turn the jog dial to select the desired character.
- ▷ Press the jog dial to go to the next position.
- ▷ Press the **SAVE** button to save the set name.



Dante Settings (only EM 6000 DANTE)

In this menu item, you can configure the network settings for the Dante™ network. This menu item is available only with the product version EM 6000 DANTE.

To open the **Dante Settings** menu item:

- ▷ Turn the jog dial in the **System** menu item until the **Dante Settings** menu item appears in the selection frame.
- ▷ Press the jog dial to open the menu.

In the **Dante Settings** menu items, 3 additional menu items are available:

- **Device ID:** shows the name of the device in the Dante™ network.
 - **Network:** enables the configuration of the network settings for using the EM 6000 DANTE in a Dante™ network.
 - **Info:** shows the MAC address of the EM 6000 DANTE and the current version of the Dante™ firmware.
- ▷ In the **Dante Settings** menu item, turn the jog dial to navigate to the desired sub-item.
 - ▷ Press the jog dial to open the desired sub-item.

Device ID

This menu item shows the device name under which the EM 6000 DANTE is available in the Dante™ network. You cannot configure any settings here.

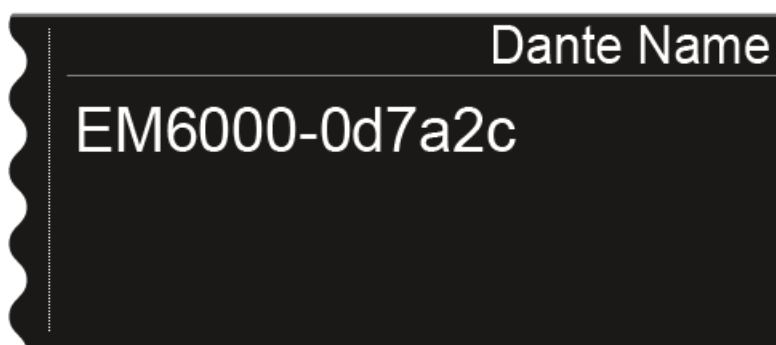



Network

- ▷ Turn the jog dial to choose between the two IP assignment modes **Auto** and **Manual**.

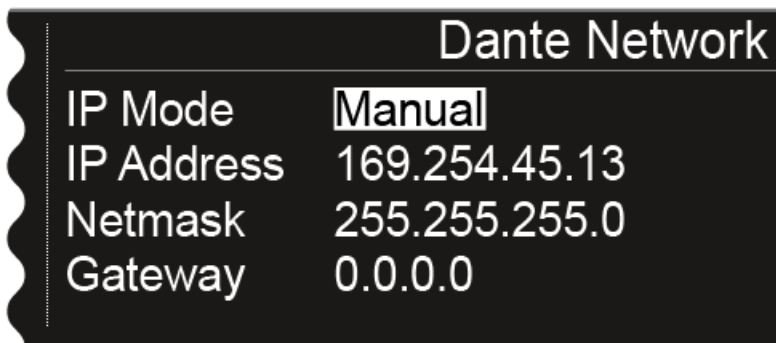
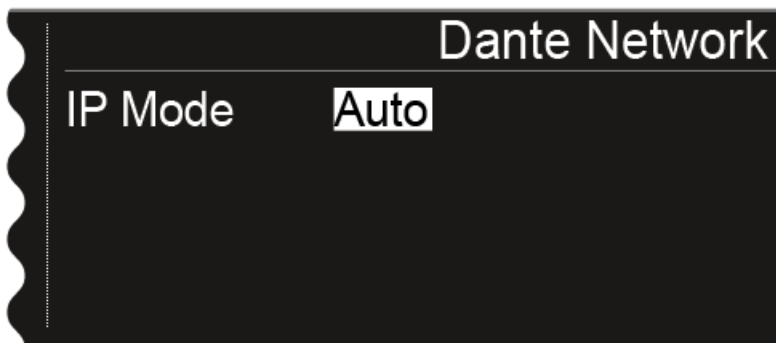

To configure the settings in **IP Mode Manual**:

- ▷ Press the jog dial to switch between the individual network configuration items.
- ▷ Turn the jog dial to set the value.

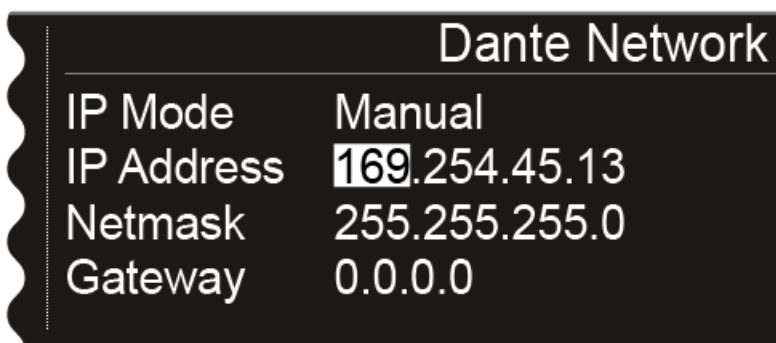

- ▷ Press the **SAVE** button to save the settings.

**Info**

This menu item shows the MAC address of the Dante™ interface and the current version of the Dante™ firmware. You cannot configure any settings here.



You can find information about updating the Dante™ firmware under “Updating the firmware of the Dante™ interface”.



Booster Feed

In this menu item, you can activate the power supply for an external antenna amplifier if you are using active remote antennas.

 You can find more information about antennas under “Recommendations for using antennas”.

To open the **Booster Feed** menu item:

- ▷ Turn the jog dial in the **System** menu item until the **Booster Feed** menu item appears in the selection frame.
- ▷ Press the jog dial to open the menu.

The following view is shown on the display.

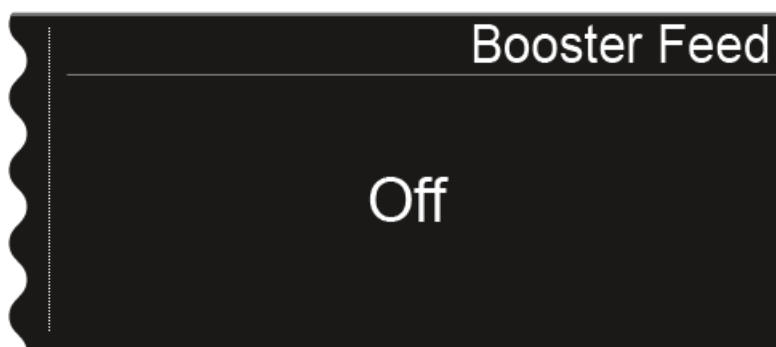

- ▷ Turn the jog dial to choose between the **On** and **Off** options.

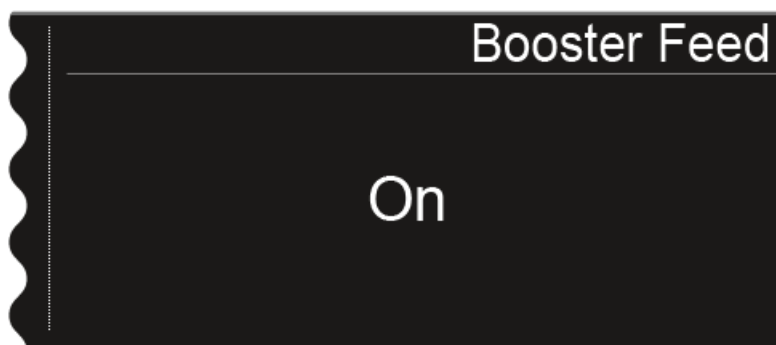

- ▷ Press the **SAVE** button to save your selection.



Switch the power supply for external antenna amplifiers on only if you are actually using external antenna amplifiers.

 If the power supply for external antenna amplifiers is activated, it becomes active immediately once the EM 6000 is connected to the power supply system, regardless of whether the EM 6000 is switched on or off. See “Connecting/disconnecting the EM 6000 to/from the power supply system”.



Brightness

In this menu item, you can set the brightness of the display. The set brightness applies to both EM 6000 displays.

To open the **Brightness** menu item:

- ▷ Turn the jog dial in the **System** menu item until the **Brightness** menu item appears in the selection frame.
- ▷ Press the jog dial to open the menu.

The following view is shown on the display

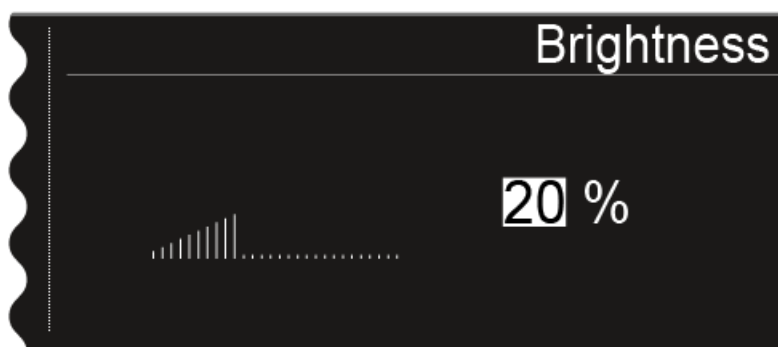

- ▷ Turn the jog dial to set the desired display brightness.
- ▷ Press the **SAVE** button to save the setting.



Auto Setup

In this menu item, you can activate the auto setup function for the EM 6000. If the function is activated here, an automatic frequency setup can be performed for this EM 6000. See “Scan & Auto-Setup menu item”.

To open the **Auto Setup** menu item:

- ▷ Turn the jog dial in the **System** menu item until the **Auto Setup** menu item appears in the selection frame.
- ▷ Press the jog dial to open the menu.

The following view is shown on the display.



- ▷ Turn the jog dial to choose between the **On** and **Off** options.



- ▷ Press the **SAVE** button to save your selection.



Info

This menu item shows the MAC address of the EM 6000 and the current version of the firmware. You cannot configure any settings here.

To open the **Info** menu item:

- ▷ Turn the jog dial in the **System** menu item until the **Info** menu item appears in the selection frame.
- ▷ Press the jog dial to open the menu.

The following view is shown on the display.

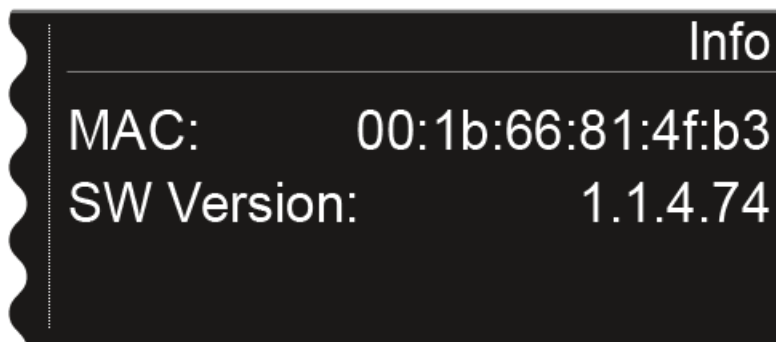

You can find information about updating the firmware under “Updating the firmware of the receiver”.

Hardware

This menu item shows information about the hardware. You cannot configure any settings here.

To open the **Hardware** menu item:

- ▷ Turn the jog dial in the **System** menu item until the **Hardware** menu item appears in the selection frame.
- ▷ Press the jog dial to open the menu.

The following view is shown on the display.

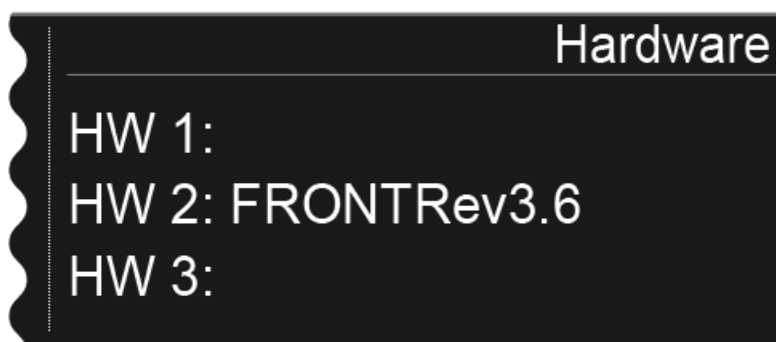



Help

In this menu item, you can find the link to the English version of this instruction manual.

TX Update

This menu item lets you perform a firmware update for the transmitters. This update is recommended after you perform a firmware update for the receiver (see “Updating the firmware of the receiver”).

To open the **TX Update** menu item:

- ▷ Turn the jog dial in the **System** menu item until the **TX Update** menu item appears in the selection frame.
- ▷ Press the jog dial to open the menu.

The following view is shown on the display.

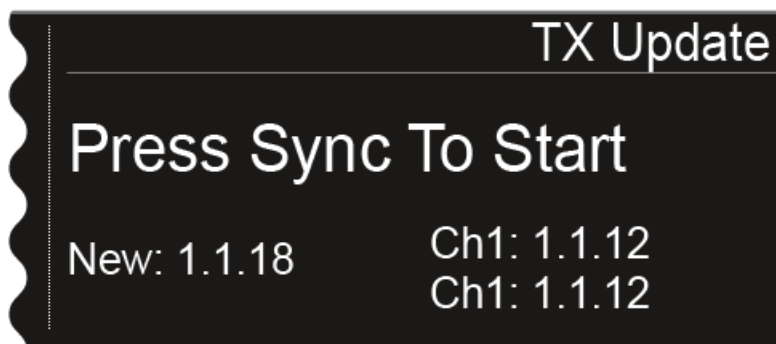

- **New** shows the version of the new firmware that is available after the firmware update for the receiver.
- **Ch1** shows the firmware that is currently installed on the transmitter for the receiving channel CH 1.
- **Ch2** shows the firmware that is currently installed on the transmitter for the receiving channel CH 2.

To start the firmware update:

- ▷ Press the Sync button for the desired channel.
- ▷ Hold the transmitter and its infrared interface in front of the infrared interface of the receiver. See “Synchronizing devices”.



Reset

This menu item allows you to reset the settings for the receiver.

There are two options:

- **Reset:** All settings apart from the network settings and the user-defined frequency banks U1 to U6 are reset.
- **Factory Reset:** All settings are reset to the factory settings.

To open the **Reset** menu item:

- ▷ Turn the jog dial in the **System** menu item until the **Reset** menu item appears in the selection frame.
- ▷ Press the jog dial to open the menu.
- ▷ Choose one of the two options **Reset** or **Factory Reset** and press the jog dial to confirm your selection.
- ▷ Press the **SAVE** button to reset the settings.



Using the headphone output

You can use the headphone output on the front of the EM 6000 (6.3 mm jack) to listen to the audio signals of the two channels.

ATTENTION



Danger due to high volume levels

Volume levels that are too high may damage your hearing.

- ▷ Turn down the volume of the headphone output before you put on the headphone.
-

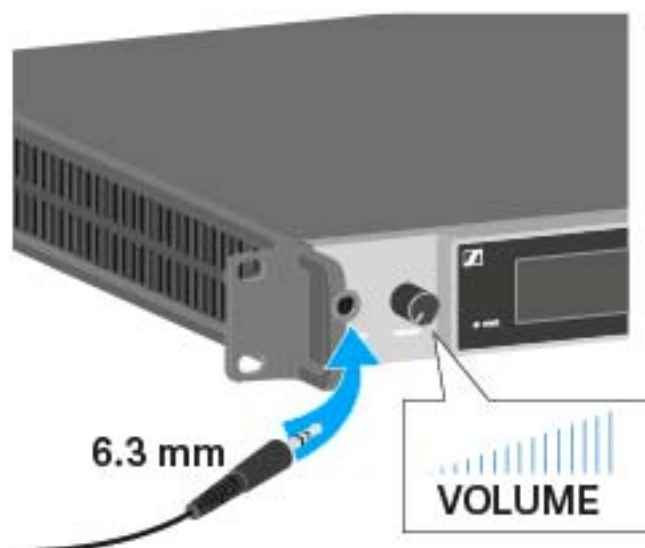

- ▷ Connect the headphone to the **HEADPHONES** socket.
- ▷  Press the headphone button on one of the two channels **CH 1** or **CH 2** to listen to that channel.
- ▷ Press both headphone buttons for the two channels to listen to both channels at the same time.
- ▷ Control the volume by turning the **VOLUME** control next to the **HEADPHONES** socket.



Updating the firmware of the receiver

You can update the firmware for the EM 6000 receiver using the **Sennheiser Wireless Systems Manager (WSM)** software.

- ▷ To do so, connect the EM 6000 to a network (see “Connecting the EM 6000 to a network”) and establish the connection with the WSM software.

i For more information about controlling devices via the Sennheiser Wireless Systems Manager (WSM) software, refer to the instruction manual for the software. You can download the software at www.sennheiser.com/download.

The firmware for the Dante™ interface of the EM 6000 DANTE cannot be updated via WSM. See “Updating the firmware of the Dante™ interface”.

Updating the firmware of the Dante™ interface

To update the Dante™ interface (Audinate Brooklyn II) for the EM 6000 DANTE, you require the **Firmware Updater** software from **Audinate**.

You can access it using the link below:

<https://www.audinate.com/products/firmware-update-manager>

- ▷ To update the firmware, connect your computer to the Dante™ interface of the EM 6000 DANTE with a network cable.



Status messages

In certain situations, the EM 6000 display may show status messages and error messages. For messages relating to errors that can impair function, the red triangle to the right of the display for the particular channel also lights up.

Message	Explanation
No Link	<p>No transmitter connected.</p> <ul style="list-style-type: none"> ▷ Check the transmitter radio link with the receiving channel. See “Establishing a radio link”.
Low Signal	<p>The reception quality between the transmitter and receiver is poor (RF A or RF B below -85 dBm, LQI between 1% and 19%)</p> <ul style="list-style-type: none"> ▷ Check the transmitter’s radio link to the receiving channel and switch to a different frequency if necessary. See “Establishing a radio link”. ▷ Check that the antennas are positioned correctly. See “Connecting remote antennas”, “Connecting rod antennas”, or “Recommendations for using antennas”.
Low battery	<p>The transmitter’s batteries or rechargeable battery pack have little battery life remaining (less than 30 minutes).</p> <ul style="list-style-type: none"> ▷ Replace the rechargeable battery or batteries.
Sync ok	<p>The synchronization of the receiving channel with the transmitter was successful.</p>
Sync Fail No Frequency	<p>The auto setup function cannot provide any more free frequencies for the transmitter frequency range.</p>
Sync Fail Frequency Rejected	<p>The transmitter frequency range is incompatible with the frequency set in the receiving channel.</p> <ul style="list-style-type: none"> ▷ Set a different frequency in the receiving channel. See “Frequency menu item”.
Sync Fail Timeout	<p>The synchronization of the receiving channel with the transmitter was unsuccessful. The infrared interface for the receiver may not have been able to establish a link to the infrared interface of the transmitter.</p> <ul style="list-style-type: none"> ▷ Hold the transmitter in front of the infrared interface for the receiver correctly. See “Synchronizing devices”.



Sync Fail Unsupported Encryption	<p>AES 256 encryption is activated on the EM 6000 but the transmitter does not support it (SK(M) 9000).</p> <ul style="list-style-type: none"> ▷ Use an SK 6000 or SKM 6000 if you want to activate encryption.
Encryption Error Sync Needed	<p>AES 256 encryption was activated on the EM 6000 but is not synchronized to the transmitter yet. The encryption cannot be activated on the transmitter. Instead, it must be transferred via the Sync function.</p> <ul style="list-style-type: none"> ▷ Synchronize the receiving channel and the transmitter. See “Synchronizing devices”.
Clock Error	<p>There is a deviation in the clock rate of the word clock (> 120 ppm for 48 kHz or > 120 ppm for 96 kHz) or there is no external word clock.</p> <ul style="list-style-type: none"> ▷ Check the word clock settings. See “Word clock scenarios for digital audio (AES3 and Dante™)”.
RF Peak	<p>The RF signal is too strong (> -12 dBm). There is a risk of overloading the receiver.</p> <ul style="list-style-type: none"> ▷ Increase the distance between the antennas and the receiver. ▷ Use passive antennas instead of active antennas if possible. ▷ If using active antennas, reduce the antenna amplification.
AF Peak	<p>The audio level of the transmitter is too high (> -2 dBFS). The signal is at risk of overloading and becoming distorted.</p> <ul style="list-style-type: none"> ▷ Check the audio level of the transmitter and adjust it. See the “Gain” menu item under “Operating the SKM 6000 menu” or “Operating the SK 6000 menu”.



Using the SKM 6000

These sections contain detailed information about operating the SKM 6000.

You can find information about installing the SKM 6000 under “Installing the SKM 6000”.



Operating elements of the SKM 6000 handheld transmitter

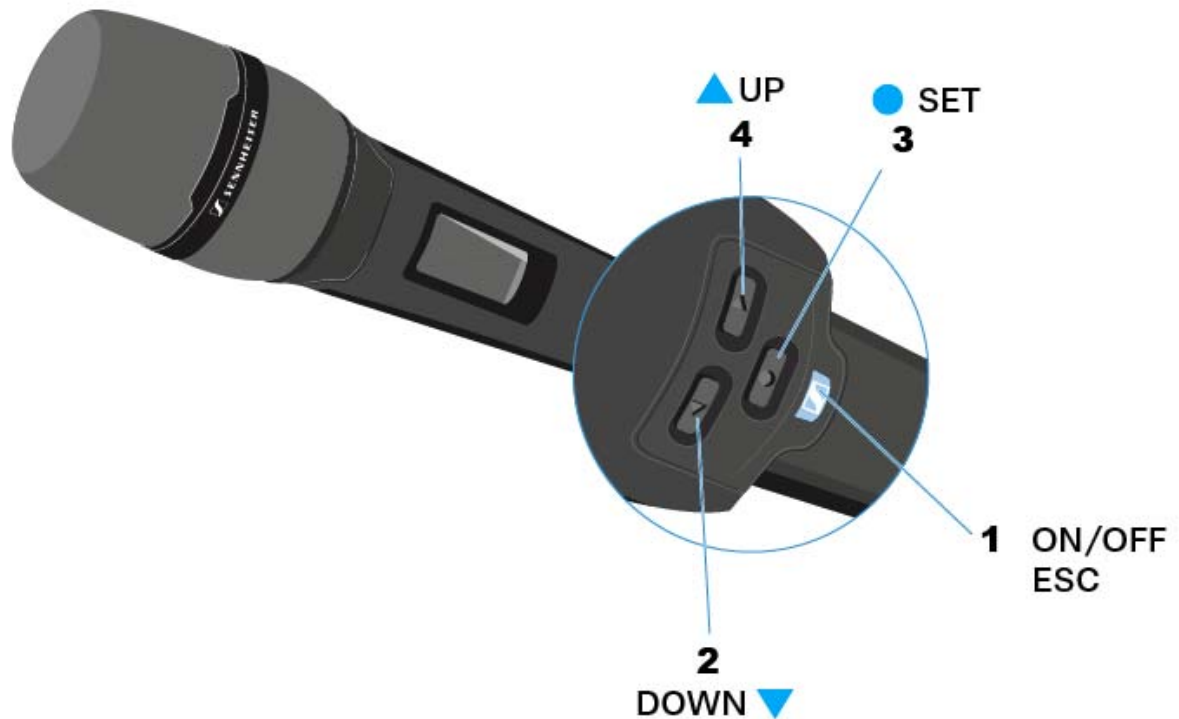

1 ON/OFF (ESC) button

- Switch the transmitter on or off
- See “Switching the SKM 6000 on and off”
- Escape function in the menu
- See “Operating the SKM 6000 menu”

2 DOWN button

- Navigate through the transmitter operating menu
- Change values in the operating menu
- See “Operating the SKM 6000 menu”

3 SET button

- Open a menu item
- Save a setting in the menu
- See “Operating the SKM 6000 menu”

4 UP button

- Navigate through the transmitter operating menu
- Change values in the operating menu
- See “Operating the SKM 6000 menu”



Switching the SKM 6000 on and off



To switch on the SKM 6000:

- Hold down the **ON/OFF** button until the Sennheiser logo appears on the display.

To switch off the SKM 6000:







- Hold down the **ON/OFF** button until the display goes off.



Displays on the SKM 6000 handheld transmitter display panel



You can view the following information on the transmitter display.

Display on the display panel	Meaning
	<p>Remaining battery life</p> <p>Shows the remaining battery life and the transmitter operating time.</p> <p>The time is displayed only if the BA 60 rechargeable battery is used.</p> <p>For normal batteries, only the charge level of the batteries is displayed without time information.</p> <p> For more information about rechargeable batteries and batteries, see “Rechargeable batteries and battery compartments”.</p>
	<p>Frequency</p> <p>Shows the set frequency.</p> <p>Alternatively, the name of the radio link can also be displayed here. See “Menu item overview”.</p>
	<p>Encryption</p> <p>The radio link between the receiver and transmitter is secured with AES 256 encryption.</p> <p>The encryption can be set only on the receiver, not on the transmitter. See “Encrypting the radio link”.</p>
	<p>Lock mode</p> <p>The lock-off is activated on the transmitter.</p> <p>See “Menu item overview”.</p>
	<p>Transmission mode</p> <p>The transmission mode for Digital 6000 series transmitters is the long range mode for the Digital 9000 series. As a result, the transmitters in the Digital 6000 series are compatible with Digital 9000 if the EM 9046 is operated in long range mode.</p>



Operating the SKM 6000 menu

Navigating through the menu

To open the menu:

- ▷ Press the **SET** button.
The operating menu is shown on the transmitter display panel.

To open a menu item:

- ▷ Press the **UP** or **DOWN** buttons to navigate through the individual menu items.
- ▷ Press the **SET** button to open the selected menu item.



“Operating elements of the SKM 6000 handheld transmitter”

Making changes in a menu item

After you open a menu item, you can make changes as follows:

- ▷ Press the **UP** or **DOWN** buttons to set the displayed value.
- ▷ Press the **SET** button to save the setting.
- ▷ Press the **ESC (ON/OFF)** button to leave the menu item without saving the setting.



“Operating elements of the SKM 6000 handheld transmitter”

Menu item overview

In the menu items, you can configure the settings below and display information.



Tune menu item

In this menu item, you can adjust a frequency in 25 kHz steps. When you save the setting, the set frequency is automatically assigned to the user-defined frequency preset **U**, the handheld transmitter switches from the frequency preset set up to now to the frequency preset **U**, and sends a radio signal to the set frequency.



Preset menu item

This menu item displays the frequency preset **U** together with its corresponding frequency. You cannot configure any settings here.



Name menu item

In this menu item, you can set a freely selectable name for the transmitter. The name can be up to 6 characters long.



If you enter a name for the radio link in the **Name** menu item on the receiver and synchronize the receiver with a transmitter, the name entered in the transmitter is overwritten with the name entered in the receiver.



Gain menu item

In this menu item, you can adjust the input gain in 3 dB steps. Alternatively, you can also adjust the input gain in the receiver and synchronize it with the transmitter. See “Sync Settings menu item”.



 The range in which the input can be adjusted varies depending on the microphone module used.



Low Cut menu item

In this menu item, you can adjust the value for the low cut filter.

Setting: 60 Hz, 80 Hz, 100 Hz, 120 Hz

Alternatively, you can also adjust the low cut filter in the receiver and synchronize it with the transmitter. See “Sync Settings menu item”.



Display menu item

In this menu item, you can choose whether the home screen on the transmitter display shows the set frequency, the frequency preset, or the name of the transmitter or radio link.

Alternatively, you can also adjust the home screen display in the receiver and synchronize it with the transmitter. See “Sync Settings menu item”.



Lock menu item

In this menu item, you can activate or deactivate the lock-off for the transmitter.

Alternatively, you can also adjust the lock-off in the receiver and synchronize it with the transmitter. See “Sync Settings menu item”.

To enable the lock-off:

- ▷ Open the **Lock** menu item and set the value to **On**.
- ▷ Save your entry by pressing the **SET** button.
The automatic lock-off function will remain activated.

To disable the lock-off:

- ▷ Press the **SET** button to open the menu.
- ▷ Use the **UP** and **DOWN** buttons to navigate to the Lock menu item.
- ▷ Press the **SET** button to open the **Lock** menu item.
The message **LOCKED** is shown on the display.
- ▷ Press the **UP** or **DOWN** button.
The message **UNLOCK** is shown on the display.
- ▷ Press the **SET** button.
The lock-off function is now temporarily disabled.
- ▷ Press the **SET** button again right away.
- ▷ Press the **UP** or **DOWN** button to set the value to **OFF**.
- ▷ Press the **SET** button to confirm your setting.
The lock-off function is now disabled.



Test Tone menu item

In this menu item, you can activate a 1 kHz test tone that the transmitter transmits instead of the input signal. Use this function to level out the system and during the walk test.

**Reset** menu item

In this menu item, you can reset the transmitter settings to the factory settings.

**Information** menu item

In this menu item, you can display the installed firmware version and the overall frequency range for the transmitter.



Updating the firmware of the SKM 6000

The transmitter firmware is updated via the receiver.

- ▷ Update the transmitter firmware via the TX Update function in the System menu item on the receiver. See “TX Update” under “System menu item”.



Using the SK 6000

These sections contain detailed information about operating the SK 6000.

You can find information about installing the SK 6000 under “Installing the SK 6000”.



Operating elements of the SK 6000 bodypack transmitter

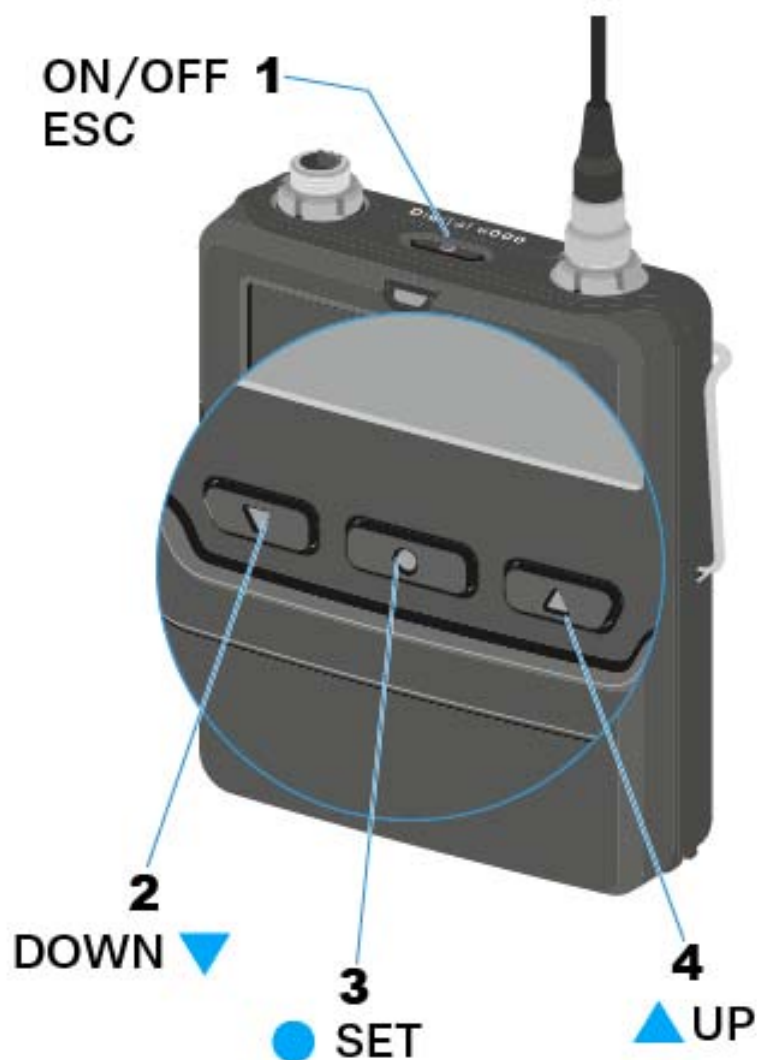

1 ON/OFF (ESC) button

- Switch the transmitter on or off
- See “Switching the SK 6000 on and off”
- Escape function in the menu
- See “Operating the SK 6000 menu”

2 DOWN button

- Navigate through the transmitter operating menu
- Change values in the operating menu
- See “Operating the SK 6000 menu”

3 SET button

- Open a menu item
- Save a setting in the menu
- See “Operating the SK 6000 menu”

4 UP button

- Navigate through the transmitter operating menu
- Change values in the operating menu
- See “Operating the SK 6000 menu”



Switching the SK 6000 on and off

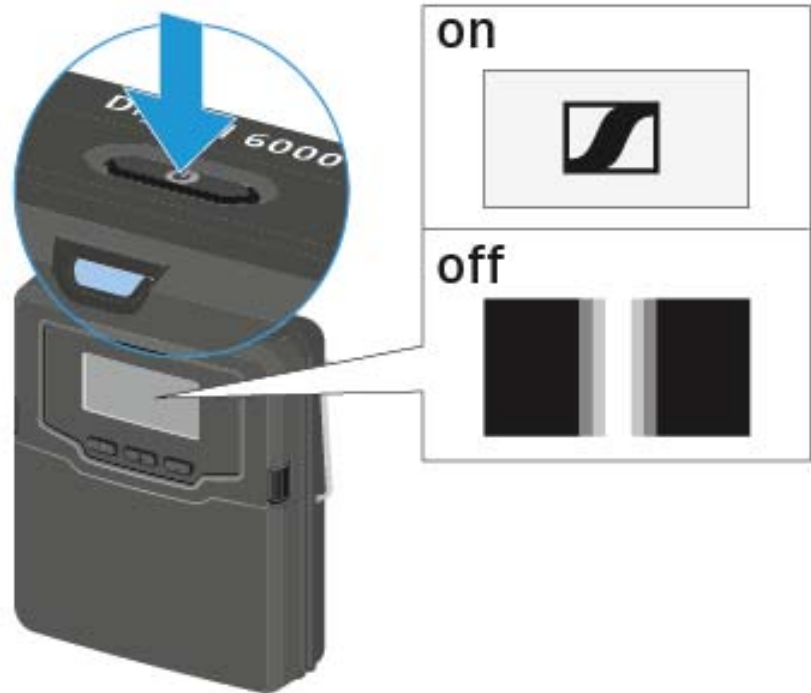

To switch on the SK 6000:

- ▶ Hold down the **ON/OFF** button until the Sennheiser logo appears on the display.

To switch off the SK 6000:



- ▶ Hold down the **ON/OFF** button until the display goes off.



Displays on the SK 6000 bodypack transmitter display panel



You can view the following information on the transmitter display.

Display on the display panel	Meaning
 4:10	<p>Remaining battery life</p> <p>Shows the remaining battery life and the transmitter operating time.</p> <p>The time is displayed only if the BA 61 rechargeable battery is used.</p> <p>For normal batteries, only the charge level of the batteries is displayed without time information.</p> <p>i For more information about rechargeable batteries and batteries, see “Rechargeable batteries and battery compartments”.</p>
637.250	<p>Frequency</p> <p>Shows the set frequency.</p> <p>Alternatively, the name of the radio link can also be displayed here. See “Menu item overview”.</p>
AES	<p>Encryption</p> <p>The radio link between the receiver and transmitter is secured with AES 256 encryption.</p> <p>The encryption can be set only on the receiver, not on the transmitter. See “Encrypting the radio link”.</p>
	<p>Lock mode</p> <p>The lock-off is activated on the transmitter. See “Menu item overview”.</p>
	<p>Transmission mode</p> <p>The transmission mode for Digital 6000 series transmitters is the long range mode for the Digital 9000 series. As a result, the transmitters in the Digital 6000 series are compatible with Digital 9000 if the EM 9046 is operated in long range mode.</p>



Operating the SK 6000 menu

Navigating through the menu

To open the menu:

- ▷ Press the **SET** button.
The operating menu is shown on the transmitter display panel.

To open a menu item:

- ▷ Press the **UP** or **DOWN** buttons to navigate through the individual menu items.
- ▷ Press the **SET** button to open the selected menu item.



“Operating elements of the SK 6000 bodypack transmitter”

Making changes in a menu item

After you open a menu item, you can make changes as follows:

- ▷ Press the **UP** or **DOWN** buttons to set the displayed value.
- ▷ Press the **SET** button to save the setting.
- ▷ Press the **ESC (ON/OFF)** button to leave the menu item without saving the setting.



“Operating elements of the SK 6000 bodypack transmitter”

Menu item overview

In the menu items, you can configure the settings below and display information.



Tune menu item

In this menu item, you can adjust a frequency in 25 kHz steps. When you save the setting, the set frequency is automatically assigned to the user-defined frequency preset **U**, the handheld transmitter switches from the frequency preset set up to now to the frequency preset **U**, and sends a radio signal to the set frequency.



Preset menu item

This menu item displays the frequency preset **U** together with its corresponding frequency. You cannot configure any settings here.



Name menu item

In this menu item, you can set a freely selectable name for the transmitter. The name can be up to 6 characters long.



If you enter a name for the radio link in the **Name** menu item on the receiver and synchronize the receiver with a transmitter, the name entered in the transmitter is overwritten with the name entered in the receiver.



Gain menu item

In this menu item, you can adjust the input gain in 3 dB steps. Alternatively, you can also adjust the input gain in the receiver and synchronize it with the transmitter. See “Sync Settings menu item”.



 The range in which the input can be adjusted varies depending on the microphone or line-cable used.



Low Cut menu item

In this menu item, you can adjust the value for the low cut filter.

Setting: 30 Hz, 60 Hz, 80 Hz, 100 Hz, 120 Hz

Alternatively, you can also adjust the low cut filter in the receiver and synchronize it with the transmitter. See “Sync Settings menu item”.



Display menu item

In this menu item, you can choose whether the home screen on the transmitter display shows the set frequency, the frequency preset, or the name of the transmitter or radio link.

Alternatively, you can also adjust the home screen display in the receiver and synchronize it with the transmitter. See “Sync Settings menu item”.



Lock menu item

In this menu item, you can activate or deactivate the lock-off for the transmitter.

Alternatively, you can also adjust the lock-off in the receiver and synchronize it with the transmitter. See “Sync Settings menu item”.

To enable the lock-off:

- ▷ Open the **Lock** menu item and set the value to **On**.
- ▷ Save your entry by pressing the **SET** button.
The automatic lock-off function will remain activated.

To disable the lock-off:

- ▷ Press the **SET** button to open the menu.
- ▷ Use the **UP** and **DOWN** buttons to navigate to the Lock menu item.
- ▷ Press the **SET** button to open the **Lock** menu item.
The message **LOCKED** is shown on the display.
- ▷ Press the **UP** or **DOWN** button.
The message **UNLOCK** is shown on the display.
- ▷ Press the **SET** button.
The lock-off function is now temporarily disabled.
- ▷ Press the **SET** button again right away.
- ▷ Press the **UP** or **DOWN** button to set the value to **OFF**.
- ▷ Press the **SET** button to confirm your setting.
The lock-off function is now disabled.



Test Tone menu item

In this menu item, you can activate a 1 kHz test tone that the transmitter transmits instead of the input signal. Use this function to level out the system and during the walk test.

**Reset** menu item

In this menu item, you can reset the transmitter settings to the factory settings.

**Information** menu item

In this menu item, you can display the installed firmware version and the overall frequency range for the transmitter.



Updating the firmware of the SK 6000



The transmitter firmware is updated via the receiver.

- ▷ Update the transmitter firmware via the TX Update function in the System menu item on the receiver. See “TX Update” under “System menu item”.



Using the L 6000

These sections contain detailed information about operating the L 6000 charger.

-  You can find general information about the L 6000 charger and its corresponding charging modules under “Modular L 6000 charger” and “Charging modules for L 6000 charger”.
-  You can find information about installing the L 6000 charger under “Installing the L 6000 | LM 6060 | LM 6061”.



Switching the L 6000 on and off

The L 6000 does not have a separate on/off switch.

Once the power supply is established, the device is switched on.



See “Connecting/disconnecting the L 6000 to/from the power supply system”.



Charging rechargeable batteries

To charge the BA 60 and BA 61 rechargeable batteries with the L 6000 charger, you require the LM 6060 or LM 6061 charging modules.

i Before charging, you have to install the charging modules in the L 6000 charger. For installation information, see “Installing the LM 6060 and LM 6061 charging modules in the L 6000”.

To charge the rechargeable batteries:

- ▷ Insert the BA 60 or BA 61 rechargeable battery into the LM 6060 or LM 6061 charging module as shown in the figure until you feel it lock into place.

The rechargeable batteries can be inserted into the charging modules only in one direction. You can see the charge level of the rechargeable batteries from the LEDs on the charging modules (see “Meaning of the LEDs on the L 6000 charger and LM 6060 and LM 6061 charging modules”).

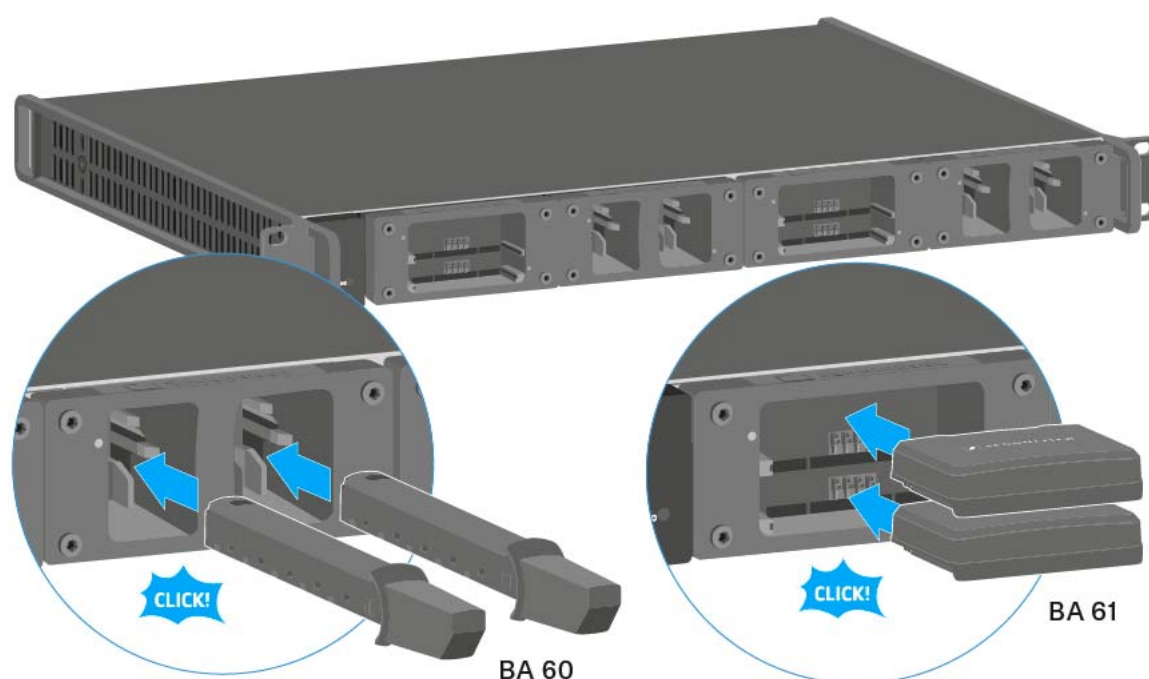









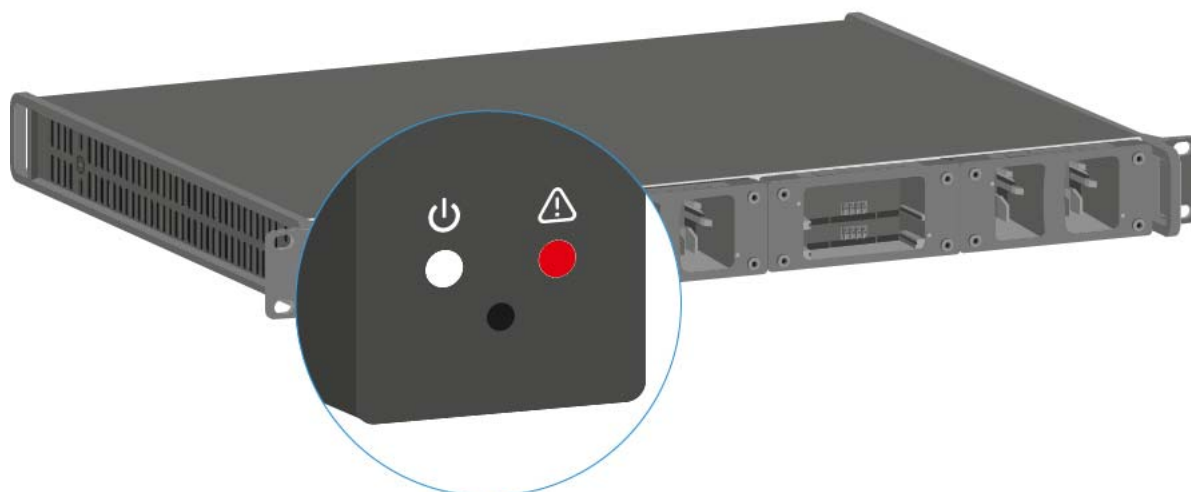

Meaning of the LEDs on the L 6000 charger and LM 6060 and LM 6061 charging modules

You can read the following information from the LEDs on the L 6000 charger and the two LM 6060 and LM 6061 charging modules:

L 6000 status LEDs

The L 6000 charger has two status LEDs on the front of the device to the left.









		White LED flashing >> device is starting or firmware is being updated
		White LED illuminated >> device is ready for operation
		Red LED flashing >> fan is damaged
		Red LED illuminated >> device is too hot and the charging process was stopped

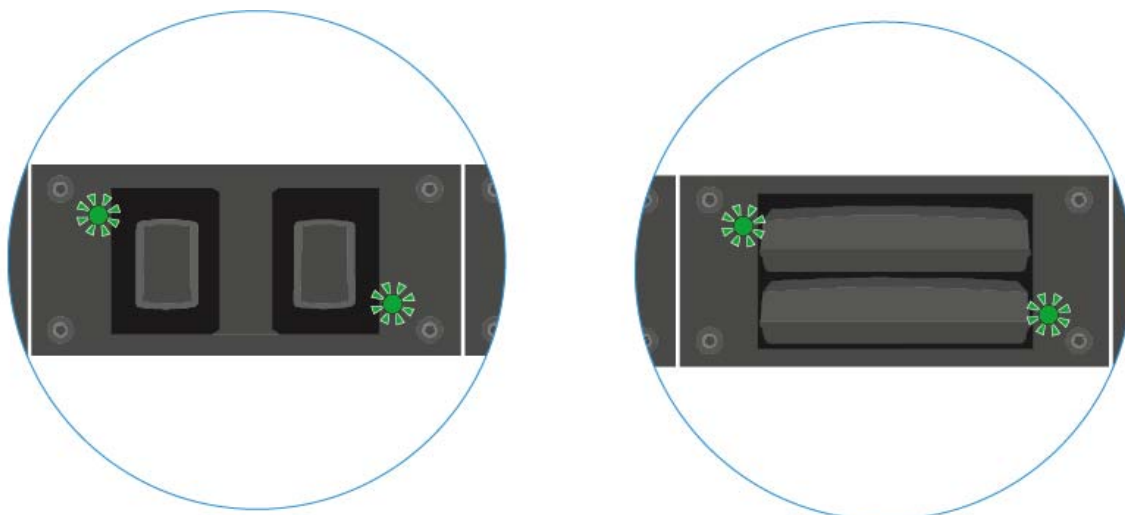

LM 6060 and LM 6061 status LEDs

The two LM 6060 and LM 6061 modules each have two charging slots. Next to each charging slot, there is a status LED that displays the following status information:



	Flashing red >> the charging slot or rechargeable battery is too hot and the charging process was stopped.
	Lights up red >> the rechargeable battery is defective.
	Flashing yellow >> the rechargeable battery is being regenerated.
	Lights up yellow >> the rechargeable battery is being charged. Charge level 0% to 80%
	Flashing green >> the rechargeable battery is being charged. Charge level 81% to 96%
	Lights up green >> the rechargeable battery is fully charged. Charge level 100%

LM 6060 and LM 6061 status LEDs in storage mode

If you are operating the L 6000 charger in **storage mode** via **WSM**, the meaning of the status indicators changes. You can find more information under “Preparing rechargeable batteries for storage (storage mode)”.



Preparing rechargeable batteries for storage (storage mode)

If you are not using the rechargeable batteries for a longer period of time and therefore want to store them, the rechargeable batteries should have a charge of approx. 70%.

You can set this level using the **storage mode** from the Sennheiser Wireless Systems Manager (WSM) software.

- ▷ To do so, connect the L 6000 charger to a network (see “Connecting the L 6000 to a network”) and establish the connection with the WSM software.

i For more information about controlling devices via the Sennheiser Wireless Systems Manager (WSM) software, refer to the instruction manual for the software. You can download the software at www.sennheiser.com/download.

Meaning of the status LEDs in storage mode

In **storage mode**, the status LEDs next to the individual charging slots show the following status information:

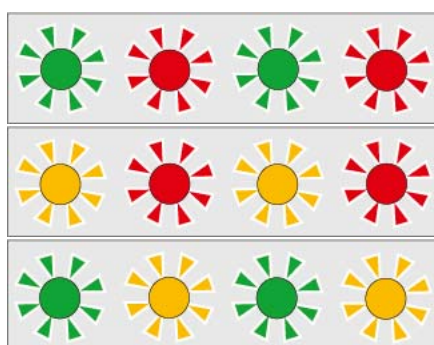
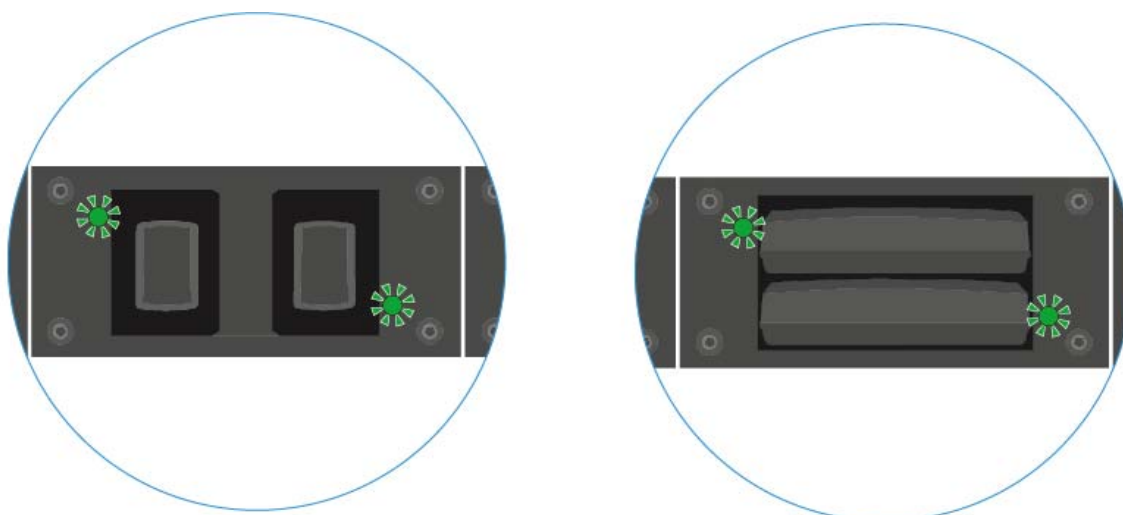

Flashing green/red >> rechargeable battery not inserted.

Flashing yellow/red >> the rechargeable battery is being charged or discharged to 70%.

Flashing green/yellow >> the rechargeable battery has reached the storage charge level of 70%.



Resetting settings (factory reset)

To reset the L 6000 charger settings to the factory settings:

- ▷ Use a pointed object to press the Reset button on the front of the L 6000 charger.

The settings are reset to the factory settings.

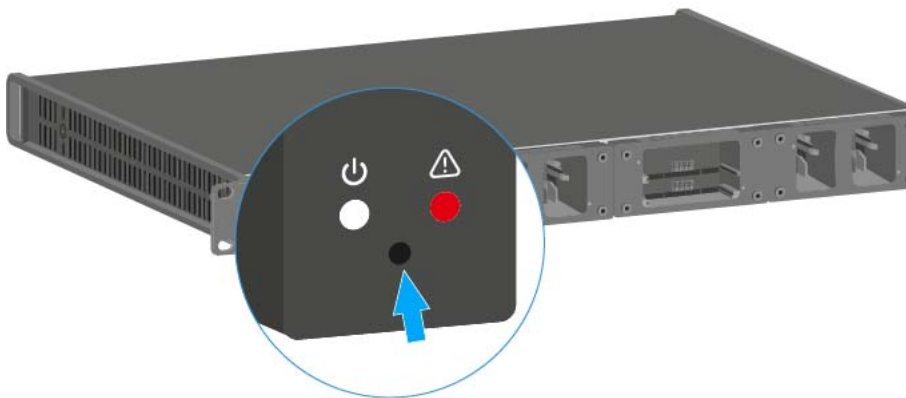



Updating the firmware

You can update the firmware for the L 6000 charger using the **Sennheiser Wireless Systems Manager (WSM)** software.

- ▷ To do so, connect the L 6000 charger to a network (see “Connecting the L 6000 to a network”) and establish the connection with the WSM software.

 For more information about controlling devices via the Sennheiser Wireless Systems Manager (WSM) software, refer to the instruction manual for the software. You can download the software at www.sennheiser.com/download.



Operating the L 6000 via a network

You can use the Sennheiser Wireless Systems Manager software to operate the charger via a network connection.

- ▷ To do so, connect the L 6000 charger to a network (see “Connecting the L 6000 to a network”) and establish the connection with the WSM software.

 For more information about controlling devices via the Sennheiser Wireless Systems Manager (WSM) software, refer to the instruction manual for the software. You can download the software at www.sennheiser.com/download.

You can perform the following actions using WSM:

- Updating the L 6000 charger firmware
- Preparing rechargeable batteries for storage (see “Preparing rechargeable batteries for storage (storage mode)”).



Establishing a radio link

Note the following points when you establish a radio link between the transmitter and receiver.

Adjusting frequencies

To establish a radio link between the transmitter and receiver, the same frequency must be set in both devices.

You can do this in a number of different ways:

1. Set a frequency in the receiving channel of the receiver (see “Frequency menu item”) and synchronize it with the transmitter (see “Synchronizing devices”).
2. Automatically allocate the frequencies using the **Auto-Setup** function (see “Scan & Auto-Setup menu item”).
3. Set the frequency on the receiving channel of the receiver and on the transmitter manually (EM 6000: “Frequency menu item”, SK 6000: “Operating the SKM 6000 menu”, SKM 6000: “Operating the SK 6000 menu”).

Encrypting the radio link

For maximum data security, you can activate AES 256 encryption for the radio link.

This function can be activated only on the receiver (see “Encryption menu item”) and then has to be synchronized to the transmitter (see “Synchronizing devices”).

Meaning of the Link Quality Indicator

The **LQI** (Link Quality Indicator) on both EM 6000 displays shows the transmission quality for the channel in question.

On the one hand, the transmission quality depends on the field strength (**RF** indicator on the receiving channel display). However, on the other hand, it also depends on external sources of interference that cannot be identified on the **RF** indicator (for example, they may be on the same frequency or a very close neighboring frequency or may not affect the RF strength).

As a basic principle, an LQI value significantly higher than 50% should be achieved for a secure transmission.



The **LQI** display shows the following information:

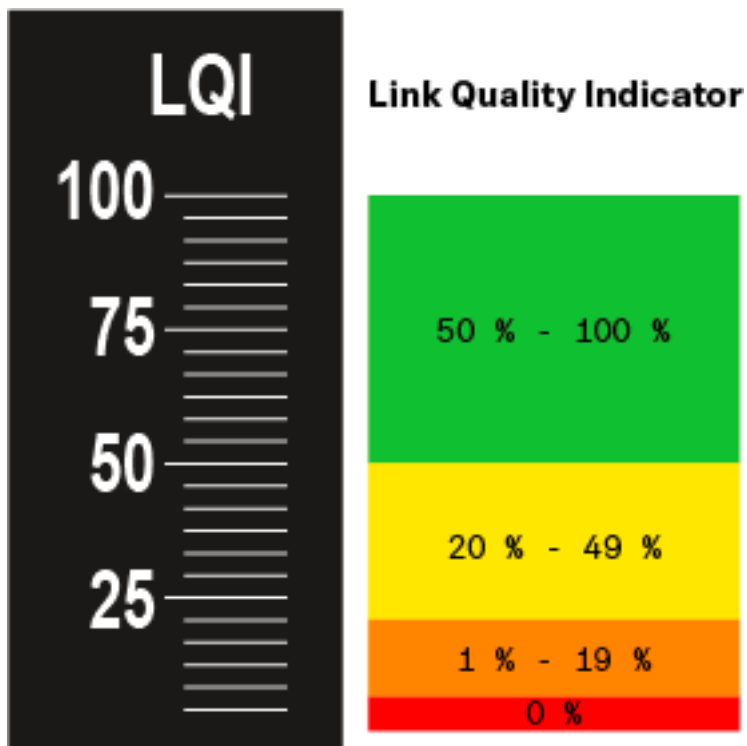

Green range from 50% to 100%:

- No transmission errors

The transmission quality is good enough to ensure an audio quality of 100%.

Yellow range from 20% to 49%:

- Individual transmission errors: short-term error correction active
- Individual audio artifacts may be audible

There are initial transmission errors. In rare cases, there are initial audible audio artifacts. Error correction may be active in this case.

Orange range from 1% to 19%:

- Frequent transmission errors: long-term error correction active
- Risk of audio drop-outs

The transmission errors increase, which means that the error correction duration also increases. There is a risk of audio drop-outs.

Red range 0%:

- No transmission

In this range, the transmission quality is so poor that audio drop-outs can no longer be avoided.



Synchronizing devices

To synchronize an EM 6000 receiving channel with a transmitter:

- Press the **SYNC** button for the desired receiving channel.



- Hold the transmitter in front of the EM 6000 infrared interface at a distance of between 3 and 30 cm (1 3/16" to 11 13/16").
- Ensure that you align the transmitter so that its infrared interface next to the display is pointing at the infrared interface of the EM 6000.
- Maintain the specified distance.





User knowledge

In this section, we want to provide you with useful background information about specific issues that play an important role in using the Digital 6000 series.

Antennas

There are different types of antennas, which are used in different ways. For more information about this subject, see “Recommendations for using antennas”.

Frequency management and an equidistant frequency grid

The Digital 6000 series can work in an equidistant frequency grid because the transmitter and receiver are free from intermodulation. For information about this subject, see “Equidistant frequency grid”.

Word clock scenarios

The EM 6000 can output digital audio signals (AES/EBU or Dante™). When doing so, correct clocking must be ensured by using a word clock. For information about this subject, see “Word clock scenarios for digital audio (AES3 and Dante™)”.



Recommendations for using antennas

Click the two options above to learn more about using rod antennas and remote antennas.

Rod antennas (included in the delivery)

The EM 6000 can be operated throughout the entire frequency spectrum with the UHF rod antennas included in the delivery.

For optimum range and reliability, we recommend using remote antennas because antennas directly on the device do not have the optimum distance from each other and cannot be aligned with the transmitters.

i You can find more information about remote antennas under “Remote antennas”.

Remote antennas

We recommend using remote antennas instead of the rod antennas supplied. Remote antennas achieve better reception.

The antennas are connected to the receiver using coaxial cables and mounted on a conventional microphone stand. They should be positioned so that at least one antenna always has a free line of sight to the transmitters. The distance between the antennas should be approx. 1 to 2 m (3.3 to 6.5 ft) to ensure a good diversity response from the receiver.

i For information about the antennas and accessories recommended by us, see “Antennas and accessories”.

Active vs passive antennas

Passive antennas do not require a power supply and do not have any electronics. Active antennas have a fitted amplifier and require a power supply.

If you are using active antennas:

- ▷ Activate the power supply for external antenna amplifiers in the EM 6000 system menu
See “Booster Feed” under “System menu item”.

If you are using passive antennas, you can use them as active antennas by using an external antenna amplifier.

General recommendation

Generally, passive antennas should be used. The EM 6000 is designed for this type of application.

Active antennas are used to balance the attenuation in the coaxial cable and supply the receivers with a sufficiently strong signal. However, this is not required with the usual cable lengths of up to approx. 10 m (32 ft).

When active antennas are used incorrectly, there is a risk of overloading the receiver. In addition, noise signals are always amplified as well as the wanted signal, which eliminates the benefit to the levels.

Types of remote antenna

Antennas with different types of pick-up pattern are available:



- **Omni-directional antennas** receive the signals from every horizontal direction equally and are not directed.
- **Directional antennas** amplify signals from a specific direction while the remaining signals are attenuated. If you want to receive only transmitters from a specific direction, for example, if the antennas are next to a stage, we recommend using this type of antenna because it can significantly improve the reception quality.

Losses due to cable properties and length

The antennas must be connected to the receivers using coaxial cables with BNC connectors.

The quality of this cable can vary greatly. The impedance must be 50 ohm and meet the RG58 standard at minimum. The cable must be mechanically undamaged and must not be kinked.

All coaxial cables have attenuation that increases with the length. Therefore, the length should not be greater than necessary and a length of 10 m (32 ft) should not be exceeded whenever possible.

- ▷ With longer cables, ensure the attenuation levels are good or use active antennas.



Equidistant frequency grid

The Digital 6000 series can work in an equidistant frequency grid because the transmitter and receiver are free from intermodulation. In this case, all of the assigned frequencies are the same distance from each other.

- The minimum frequency spacing is then 600 kHz.
- The minimum distance from the transmitters to the antennas should be 4 m (13 ft).
- You can set up the equidistant frequency grid only if you are using exclusively Digital 6000 and Digital 9000 units in the production environment.

Setting up the equidistant frequency grid

You can set up the equidistant frequency grid in a number of different ways:

1. You can set it up automatically using the **Auto Setup** function. **Frequency bank E**, which is provided for this purpose, is configured here. You can find more information about this subject under “Scan & Auto-Setup menu item”. To use this function, all of the EM 6000 devices must be connected to the same network.
2. You can configure the function via the Sennheiser **WSM** software. The **WSM** software is available to download free of charge online at www.sennheiser.com.
3. You can set it up manually on all of the receiving channels in your production environment. Configure each receiving channel so that they have the same frequency spacing from each other (at least 600 kHz). With this variant, you can also scan the environment in banks B1 to B6 (see “Scan & Auto-Setup menu item”) and manually transfer the free frequencies that are then displayed to your systems.

After you set up the frequencies for the individual receiving channels, the frequencies then just have to be transferred to the corresponding transmitters via the **Sync** function.

For information about the **Sync** functions, see “Synchronizing devices”.



Word clock scenarios for digital audio (AES3 and Dante™)

The EM 6000 supports two clock rates: **48 kHz** and **96 kHz** (see “Word-clock” under “System menu item”).

You can use either the **internal word clock** on the EM 6000 or connect an **external word clock** (see “Connecting the word clock”).

An external word clock can also be forwarded to a downstream device via the word clock output. This feature allows you to cascade up to 16 EM 6000 devices.

i Note that only the word clock on the word clock input can be forwarded via the word clock output. The internal word clock is not forwarded via the word clock output.

Word clock with analog audio

A clock generator is always required. For purely analog audio, the internal word clock has to be used for clocking because a digital clock generator is not available. If an external word clock is connected but no usable signal is detected, the EM 6000 automatically switches to the internal word clock.

For the analog audio outputs on the EM 6000, the clock rate is unimportant because it always operates at the better clock rate of 96 kHz. The selection of the clock rate affects only the clocking for the AES3 stream and the Dante™ interface (see below).

Word clock with digital audio

If multiple devices with digital audio signals are connected in a production environment, their clock signals must be synchronized via a word clock, otherwise audio errors occur. The word clock of one device becomes the master. All of the other devices become slaves and synchronize with the master.

AES3

The selection of the internal clock rate determines the clocking for the AES3 stream. In an AES3 application, the device connected to the EM 6000 via the digital audio output can be synchronized via the audio stream.

If there are multiple AES3 connections, the EM 6000 must be synchronized with all of the other devices externally via the word clock input and output.

Dante™

The **Audinate Brooklyn II** Dante™ interface installed in the EM 6000 should be understood as a standalone digital audio device with its own word clock and also has to be clocked either internally or externally.

i You require the **Dante Controller** software from **Audinate** for these settings. You can access it using the link below:

Audinate Dante Controller



Defining the master and slave

The EM 6000 word clock input, the EM 6000 internal word clock, the word clock of the Audinate Brooklyn II Dante™ interface, or the Dante™ network can be defined as the master.

To define the **internal word clock** of the **EM 6000** as the **master**:

- ▷ In the **Wordclock** menu in the EM 6000 **System** menu item, choose the option **Internal 48 kHz** or **Internal 96 kHz** (see “Wordclock” under “System menu item”).
- ▷ In the **Audinate Dante Controller** software, activate the options **Enable Sync to External** and **Preferred Master**.

To define the **BNC word clock input** of the **EM 6000** as the **master**:

- ▷ In the **Wordclock** menu in the EM 6000 **System** menu item, choose the option **External BNC** (see “Wordclock” under “System menu item”).
- ▷ In the **Audinate Dante Controller** software, activate the options **Enable Sync to External** and **Preferred Master**.

To define the **Dante™ interface** of the **EM 6000** as the **master**:

- ▷ In the **Wordclock** menu in the EM 6000 **System** menu item, choose the option **External Dante** (see “Wordclock” under “System menu item”).
- ▷ In the **Audinate Dante Controller** software, deactivate the option **Enable Sync to External**.
- ▷ In the **Audinate Dante Controller** software, activate the option **Preferred Master**.

To define the **Dante™ interface** of the **EM 6000** as the **slave**:

- ▷ In the **Wordclock** menu in the EM 6000 **System** menu item, choose the option **External Dante** (see “Wordclock” under “System menu item”).
- ▷ In the **Audinate Dante Controller** software, deactivate the options **Enable Sync to External** and **Preferred Master**.



Overview

In the sections below, you can find information about the different variants of the products in the Digital 6000 series as well as technical data in relation to the system and individual products.

- Product variants and frequency variants >> “Product variants”
- Frequency table with an overview of all banks and channels >> “Frequency table”
- System-specific and product-specific technical data >> “Specifications”

You can also find information about safely cleaning and maintaining Digital 6000 series products.

- “Cleaning and maintenance”



Product variants

In the following sections, you can find all of the variants of the system components together with specifications of the frequency ranges and article numbers.



EM 6000 | EM 6000 DANTE product variants

The following product variants of the EM 6000 2-channel receiver are available:

Product	Frequency range	Article no.
EM 6000 EU	470 to 714 MHz	506657
EM 6000 UK	470 to 714 MHz	506658
EM 6000 US	470 to 714 MHz	506659
EM 6000 DANTE EU	470 to 714 MHz	507303
EM 6000 DANTE UK	470 to 714 MHz	507304
EM 6000 DANTE US	470 to 714 MHz	507305

SKM 6000 product variants

The following product variants of the SKM 6000 handheld transmitter are available:

Product	Frequency range	Article no.
SKM 6000 A1-A4	470,000 to 558,000 MHz	506302
SKM 6000 A5-A8	550,000 to 638,000 MHz	506303
SKM 6000 B1-B4	630,000 to 718,000 MHz	506304
SKM 6000 A5-A8 US	550,000 to 607,000 MHz 614,100 to 638,000 MHz	506367
SKM 6000 B1-B4 US	630,000 to 697,900 MHz	506368
SKM 6000 A1-A2 CN	470,100 to 509,900 MHz	506322
SKM 6000 B1-B4 CN	630,100 to 718,000 MHz	506323
SKM 6000 A1-A4 JP	470,150 to 558,000 MHz	506337
SKM 6000 A5-A8 JP	550,000 to 638,000 MHz	506338
SKM 6000 B1-B4 JP	630,000 to 713,850 MHz	506339
SKM 6000 A1-A4 KR	470,100 to 558,000 MHz	506352
SKM 6000 A5-A8 KR	550,000 to 638,000 MHz	506353



Product	Frequency range	Article no.
SKM 6000 B1-B4 KR	630,000 to 697,900 MHz	506354



SK 6000 product variants

The following product variants of the SK 6000 bodypack transmitter are available:

Product	Frequency range	Article no.
SK 6000 A1-A4	470,000 to 558,000 MHz	506318
SK 6000 A5-A8	550,000 to 638,000 MHz	506319
SK 6000 B1-B4	630,000 to 718,000 MHz	506320
SK 6000 A5-A8 US	550,000 to 607,000 MHz 614,100 to 638,000 MHz	506375
SK 6000 B1-B4 US	630,000 to 697,900 MHz	506376
SK 6000 A1-A2 CN	470,100 to 509,900 MHz	506334
SK 6000 B1-B4 CN	630,100 to 718,000 MHz	506335
SK 6000 A1-A4 JP	470,150 to 558,000 MHz	506349
SK 6000 A5-A8 JP	550,000 to 638,000 MHz	506350
SK 6000 B1-B4 JP	630,000 to 713,850 MHz	506351
SK 6000 A1-A4 KR	470,100 to 558,000 MHz	506364
SK 6000 A5-A8 KR	550,000 to 638,000 MHz	506365
SK 6000 B1-B4 KR	630,000 to 697,900 MHz	506366

L 6000 product variants

The following product variants of the L 6000 charger are available:

Product	Article no.
L 6000 EU	507300
L 6000 UK	507301
L 6000 US	507302



LM 6060 and LM 6061 product variants

The following charging modules are available for the L 6000 charger:

Product	Article no.
LM 6060	507198
LM 6061	507199



Frequency table

i You can find a printable version of this frequency table in PDF format on the Digital 6000 product page at www.sennheiser.com or in the global download area on the Sennheiser website at www.sennheiser.com/download.

The **frequency table** below provides an overview of the factory pre-set frequency banks **B1** to **B6**. These frequency banks contain between 57 and 66 channels.

In this case, the frequency grid is intermodulation-free and should be maintained to ensure interference-free operation when using the Digital 6000 in combination with other wireless products in larger systems.

An additional frequency bank, **E**, is available for the equidistant frequency grid; this frequency bank starts at 470.200 MHz and is divided into frequency intervals of 600 kHz. See “Equidistant frequency grid”.

	Bank 1 A1-A4 470-558 MHz	Bank 2 A5-A8 550-638 MHz	Bank 3 B1-B4 630-714 MHz	Bank 4 A1-A4 A5-A8 470-678 MHz	Bank 5 A1-A4 B1-B4 470-558 MHz 630-714 MHz	Bank 6 A1-A4 A5-A8 B1-B4 470-558 MHz 550-638 MHz 630-714 MHz
Channel 00	470,200	550,200	630,850	470,200	470,700	470,250
Channel 01	470,700	550,700	637,250	470,700	473,400	470,900
Channel 02	471,300	551,300	638,300	471,300	478,280	471,700
Channel 03	472,000	552,000	640,550	472,000	478,850	472,300
Channel 04	472,800	552,800	647,800	472,800	479,300	474,450
Channel 05	473,700	553,700	650,950	473,700	484,800	479,450
Channel 06	474,700	554,700	655,650	474,700	488,250	486,300
Channel 07	475,250	555,250	667,400	475,250	492,350	490,900
Channel 08	475,900	555,900	670,150	475,900	493,600	494,750
Channel 09	477,900	557,900	674,400	477,900	498,100	515,650
Channel 10	478,850	558,850	677,300	478,850	504,050	524,950
Channel 11	481,350	561,350	681,150	481,350	514,800	535,250
Channel 12	482,200	562,200	685,200	482,200	518,950	548,550
Channel 13	484,150	564,150	688,250	484,150	526,650	553,050
Channel 14	487,700	567,700	689,600	487,700	528,150	560,150
Channel 15	489,850	569,850	694,450	489,850	534,150	568,500
Channel 16	494,400	574,400	696,300	494,400	535,100	573,600
Channel 17	495,750	575,750	699,850	495,750	538,850	576,700
Channel 18	498,800	578,800	701,800	498,800	544,650	578,350
Channel 19	502,850	582,850	702,850	502,850	548,750	582,050
Channel 20	506,700	586,700	705,150	506,700	551,150	595,450
Channel 21	509,600	589,600	708,100	508,600	552,500	601,150
Channel 22	513,850	593,850	708,100	513,850	631,250	605,950
Channel 23	516,600	601,150	708,750	516,600	632,050	607,850
Channel 24	528,350	607,000	709,300	521,950	635,900	611,100
Channel 25	533,050	616,600	710,300	528,350	640,350	613,450
Channel 26	536,200	621,500	711,200	529,950	643,150	623,350
Channel 27	543,450	628,200	712,000	536,100	647,700	634,500
Channel 28	545,700	627,450	712,700	542,550	653,150	640,300
Channel 29	546,750	630,200	713,200	551,700	656,700	644,200
Channel 30	553,150	632,250	713,800	558,600	661,850	648,450
Channel 31	554,750	635,850	471,450	563,850	673,500	650,400
Channel 32	557,000	636,600	473,100	573,550	682,650	659,950
Channel 33	563,450	471,100	479,050	585,000	685,050	662,900
Channel 34	572,400	472,700	488,700	591,500	688,150	673,300
Channel 35	592,750	474,850	495,250	600,800	692,100	680,100
Channel 36	600,700	481,000	513,600	603,050	693,150	684,200
Channel 37	605,450	488,750	517,250	608,600	697,950	688,900
Channel 38	623,450	498,300	519,600	616,200	699,500	691,150
Channel 39	626,000	498,800	528,400	619,850	702,900	697,000
Channel 40	645,750	681,750	538,250	628,850	706,100	699,450
Channel 41	657,600	694,300	558,000	634,850	709,900	700,800
Channel 42	664,400	705,350	560,550	637,150	712,350	704,000
Channel 43	666,750	713,700	578,550	659,500	713,250	707,450
Channel 44	670,400	470,275	583,300	678,400	576,300	710,150
Channel 45	688,750	470,625	591,250	683,400	605,050	711,900
Channel 46	695,300	472,025	611,600	690,450	550,525	713,500
Channel 47	704,950	479,025	620,550	701,050	555,625	471,325
Channel 48	710,900	486,825	626,400	711,800	557,725	473,425
Channel 49	712,550	487,975	629,250	473,225	571,175	474,925
Channel 50	558,025	482,425	472,375	477,025	586,425	475,275
Channel 51	558,775	515,125	477,925	482,875	588,025	478,075
Channel 52	559,175	527,475	486,275	487,325	590,075	491,675
Channel 53	564,925	659,875	505,825	507,725	594,825	495,325
Channel 54	585,675	672,100	521,325	588,775	607,825	505,925
Channel 55	598,425	673,625	535,675	604,425	627,325	536,475
Channel 56	632,925	683,375	541,475	619,125	634,925	563,175
Channel 57	642,525	689,125	551,075	648,425		632,725
Channel 58	648,325	700,975	585,575	653,125		635,275
Channel 59	662,675	704,125	598,325	661,925		669,375
Channel 60	678,175	711,375	619,075	666,725		672,375
Channel 61	697,725		624,825	686,475		698,925
Channel 62	706,075		625,225	698,975		
Channel 63	711,625		625,975	703,400		
Channel 64				711,225		
Channel 65				713,775		



Specifications

You can find the cross-system and product-specific technical data in the sections below.



System

Frequency range	470 to 714 MHz
Transmission system	Digital modulation, "LR" mode Min. frequency spacing for equidistant grid: 600 kHz
Audio codec	SeDAC (Sennheiser Digital Audio Co-dec)
Dynamic range	111 dB(A), typical
Latency	Analog audio out: 3 ms Digital audio out: 3 ms (AES/EBU)
Total harmonic distortion (THD)	< 0.03% (@ 1 kHz)
Encryption	AES 256
Temperature	Operation: -10 °C to +50 °C (14 °F to 122 °F) Storage: -25 °C to +70 °C (-13 °F to 158 °F)
Relative air humidity	Operation: Max. 85% at 40 °C (104 °F) (non-condensing) Storage: Max. 90% at 40 °C (104 °F) (non-condensing)
Dripping and splashing liquids	The product must not be exposed to dripping and splashing (IP2X)



EM 6000

Receiving channels	2
Receiver principle	Double superheterodyne
Diversity	True bit diversity
Frequency range	470 to 714 MHz
Sensitivity	-100 dBm, typical
Image rejection	> 100 dB, typical
Blocking	> 80 dB, typical
Audio frequency response	30 Hz to 20 kHz (1.5 dB)
Analog audio outputs	One XLR-3 and 6.3 mm (1/4") jack per channel (transformed-balanced), -10 dBu to +18 dBu in steps of 1 dB (2 k Ω)
Digital audio outputs	AES3-2003, XLR-3: 48 kHz, 96 kHz, 24 bit Can be externally synchronized using WCLK loop-through with BNC sockets
Headphone output	6.3 mm (1/4") jack, 2 \times 100 mW at 32 Ω
Antenna inputs	2 \times BNC (50 Ω)
Daisy chain outputs	2 \times BNC (50 Ω) 0 dB +/- 0.5 dB amplification relative to antenna inputs
Daisy-chained receivers (HF)	Max. 8 EM 6000 units
Booster supply voltage	12 V DC, max. 200 mA each via antenna sockets, short circuit proof
Word clock input	BNC, 75 Ω
Word clock output	BNC, 75 Ω
Word clock sampling rates	48 kHz, 96 kHz
Network	IEEE 802.3-2002 (10/100 Mbit/s), shielded RJ-45 connection
Power supply	100 to 240 V AC, 50/60 Hz
Power consumption	Max. 35 W
Power plug	3-pin, protection class I as per IEC/EN 60320-1
Dimensions (H \times W \times D with mounting elements)	44 \times 483 \times 373 mm (1 3/4" \times 19" \times 14 11/16")
Weight	approx. 5.2 kg (11 lbs 7 oz)



EM 6000 DANTE

Receiving channels	2
Receiver principle	Double superheterodyne
Diversity	True bit diversity
Frequency range	470 to 714 MHz
Sensitivity	-100 dBm, typical
Image rejection	> 100 dB, typical
Blocking	> 80 dB, typical
Audio frequency response	30 Hz to 20 kHz (1.5 dB)
Analog audio outputs	One XLR-3 and 6.3 mm (1/4") jack per channel (transformed-balanced), -10 dBu to +18 dBu in steps of 1 dB (2 k Ω)
Digital audio outputs	AES3-2003, XLR-3: 48 kHz, 96 kHz, 24 bit Dante™, RJ-45: 48 kHz, 96 kHz, 24 bit Can be externally synchronized using WCLK loop-through with BNC sockets
Headphone output	6.3 mm (1/4") jack, 2× 100 mW at 32 Ω
Antenna inputs	2× BNC (50 Ω)
Daisy chain outputs	2× BNC (50 Ω) 0 dB +/- 0.5 dB amplification relative to antenna inputs
Daisy-chained receivers (HF)	Max. 8 EM 6000 units
Booster supply voltage	12 V DC, max. 200 mA each via antenna sockets, short circuit proof
Word clock input	BNC, 75 Ω
Word clock output	BNC, 75 Ω
Word clock sampling rates	48 kHz, 96 kHz
Network	IEEE 802.3-2002 (10/100 Mbit/s), shielded RJ-45 connection
Dante™	IEEE 802.3 (1000 Mbit/s), shielded RJ-45 connection
Power supply	100 to 240 V AC, 50/60 Hz
Power consumption	Max. 35 W



Power plug	3-pin, protection class I as per IEC/EN 60320-1
Dimensions (H × W × D with mounting elements)	44 × 483 × 373 mm (1 3/4" x 19" x 14 11/16")
Weight	approx. 5.2 kg (11 lbs 7 oz)



SKM 6000

Frequency range	470 to 718 MHz Different frequency variants: see "SKM 6000 product variants"
Switching bandwidth	88 MHz
Frequency stability	< 5 ppm
Tunability	25 kHz steps
Lower frequency limit (-3 dB)	Adjustable: 80 Hz, 100 Hz, 120 Hz
RF output power	25 mW rms, 50 mW peak
Audio frequency response	30 Hz to 20 kHz (3 dB)
Audio amplification	Can be set in 3 dB steps from 0 dB to +62 dB (for each capsule)
Operating time	5.5 h (with BA 60 accupack)
Power consumption	Max. 960 mW
Dimensions (L × D)	270 × 40 mm (10 5/8" × 1 9/16")
Weight	Approx. 350 g (with BA 60 accupack and ME 9005 microphone module)



SK 6000

Frequency range	470 to 718 MHz Different frequency variants: see "SK 6000 product variants"
Switching bandwidth	88 MHz
Frequency stability	< 5 ppm
Tunability	25 kHz steps
Lower frequency limit (-3 dB)	Mic: adjustable, 60 Hz, 80 Hz, 100 Hz, 120 Hz Instruments/line: 30 Hz
RF output power	25 mW rms, 50 mW peak
Audio frequency response	Line: 30 Hz to 20 kHz (3 dB) Mic: 60 Hz to 20 kHz (3 dB)
Audio amplification	Mic: adjustable in 3 dB steps from 0 dB to +42 dB Instruments: adjustable in 3 dB steps from -6 dB to +42 dB Line: adjustable in 3 dB steps from -6 dB to +42 dB
Mic/line input	3-pin audio socket
Instrument cable emulation	Adjustable cable length with 3 steps
Antenna output	Coaxial socket
Operating time	6.5 h (with BA 61 accupack)
Power consumption	Max. 960 mW
Dimensions (H × W × D)	76 × 62 × 20 mm (3" x 2 7/16" x 3/ 4") (with BA 61 accupack)
Weight	approx. 147 g (with BA 61 accupack and belt clip)



L 6000

Charging capacity	Up to 8 accupacks (BA 60 and BA 61) across 4 exchangeable charging modules (LM 6060 and LM 6061)
Charging times	BA 60: 80%: approx. 1:15 h (approx. 4:45 h operating time) Full: approx. 2:30 h BA 61: 80%: approx. 1:45 h (approx. 5:00 h operating time) Full: approx. 3:15 h
Maximum charging voltage	4.2 V
Maximum charging current	2 A
Average discharge current	0.15 A
Charging temperature range	0 to 50 °C (32 °F to 122 °F)
Charging status display	Multi-colored
Network	IEEE 802.3-2002 (10/100 Mbit/s), shielded RJ-45 connection
Power supply	100 to 240 V AC, 50/60 Hz
Maximum power consumption	85 W
Minimum power consumption	1 W
Power plug	3-pin, protection class I In accordance with IEC/EN 60320-1
Dimensions (H×W×D with mounting elements)	44 × 483 × 373 mm (1 3/4" x 19" x 14 11/16")
Weight	5.1 kg (11 lbs 4 oz)

**LM 6060 | LM 6061**

Dimensions (H × W × L)	44 × 99 × 182 mm (1 3/4" x 3 7/8" x 7 3/16")
Weight	144 g (5.5 oz)
Rechargeable battery type	LM 6060: 2× BA 60 LM 6061: 2× BA 61

**BA 60 | BA 61**

Charging capacity	BA 60: 1600 mAh
	BA 61: 2000 mAh

Output voltage	BA 60: 3.7 V
	BA 61: 3.7 V



Cleaning and maintenance

Note the following information when cleaning and maintaining Digital 6000 series products.

CAUTION

Liquids can damage the products' electronics.

Liquids entering the product housing can cause a short-circuit and damage the electronics.

- ▷ Keep all liquids away from the products.
- ▷ Do not use any solvents or cleansing agents.

-
- ▷ Disconnect the products from the power supply system and remove rechargeable batteries and batteries before you begin cleaning.
 - ▷ Clean all products only with a soft, dry cloth.

- ▷ Note the special cleaning instructions below for the following products.

Cleaning the sound inlet basket of the microphone module

- ▷ Unscrew the top sound inlet basket from the microphone module by turning it counterclockwise.
- ▷ Remove the foam insert.

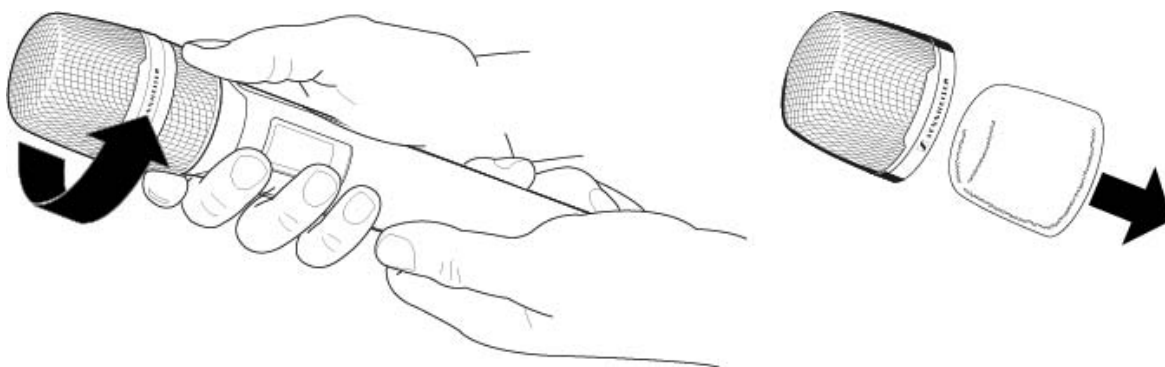

You can clean the sound inlet basket in two ways:

- Use a slightly damp cloth to clean the top sound inlet basket from the inside and outside.
- Use a brush and rinse with clean water.
- ▷ If necessary, clean the foam insert with a mild detergent or replace the foam insert.
- ▷ Dry the top sound inlet basket and foam insert.
- ▷ Reinsert the foam insert.
- ▷ Screw the sound inlet basket back onto the microphone module.



From time to time, you should also clean the microphone module contacts:

- ▷ Wipe the contacts of the microphone module with a soft, dry cloth.

Cleaning the SK 6000 bodypack transmitter contacts.

Wipe the contacts with a dry cloth.

Cleaning the L 6000 charger

- ▷ Remove all rechargeable batteries from the charging slots.
- ▷ Disconnect the L 6000 charger from the power supply system before cleaning.
- ▷ Clean the product with a dry cloth.
- ▷ In addition, use a brush to remove dust from the charging slots.
- ▷ Clean the charging contacts from time to time with a cotton swab, for instance.