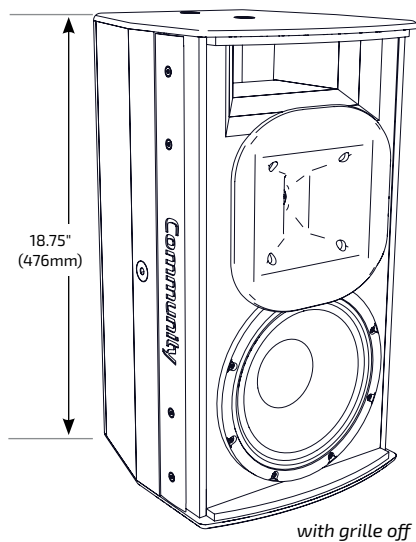

**I SERIES**  
 Compact 600

# IC6-1082/26

 HIGH OUTPUT 8-INCH TWO-WAY  
 120° x 60° INSTALLATION LOUDSPEAKER

**APPLICATIONS**
**MAIN PA or DISTRIBUTED**

 Restaurants · Presentation Suites · Auditoriums  
 Retail Spaces · Smaller Houses of Worship · Stadiums  
 Theme Parks · Cruise Ships · Entrance Halls

**FILL or DELAY**

 Houses of Worship · Auditoriums · Arenas · Stadiums  
 Theaters · Themed Entertainment · Under Balcony  
 Stage Lip Fill

**DESCRIPTION**

I SERIES Compact 600 loudspeakers provide excellent acoustic performance, flexibility and elegant aesthetics for a diverse range of applications in today's performance venues. Designed to support the goals of systems integrators and consultants in need of very compact loudspeakers with exceptional near field fidelity for foreground or background music applications and articulate voice projection with very high output capabilities for fill and distributed applications. I SERIES Compact loudspeakers are engineered to be used alone or integrated into arrays along with I SERIES Point Source (IP) or Subwoofer (IS) models using the comprehensive selection of available BalancePoint™ Flyware modular array brackets.

The IC6-1082/26 is designed for maximum performance in a minimal size enclosure. The large, rotatable horn coupled to a 1.75" (44mm) diaphragm HF driver provides consistent directivity and smooth response through the critical voice band, then seamlessly integrates with the high output 8" LF through the crossover region. The precisely engineered low velocity, flared port ensures low distortion, extended LF performance at any output level. Additionally, 8 ohm or 70V/100V models expand application flexibility both indoors and out. Multiple attachment points provide compatibility with a variety of Community and third party mounting brackets.

**FEATURES**

- Excellent LF extension and output in a very small enclosure
- Exceptional fidelity with elegant I SERIES aesthetics
- Large, field-rotatable HF horn for smooth, consistent coverage
- Low impedance (8 ohm) or 70V/100V models available
- Low profile U-Bracket or Vertical Yoke available, compatible with most third party wall and ceiling brackets

**TECHNICAL SPECIFICATIONS<sup>1</sup>**

<b>Operating Mode</b>	Low Impedance or 70V/100V models				
<b>Operating Environment</b>	Indoor or Weather-Resistant Outdoor				
<b>Operating Range<sup>2</sup></b>	52 Hz to 19.5 kHz				
<b>Nominal Beamwidth (H x V)</b>	120° x 60°, rotatable waveguide				
<b>Transducers</b>	LF 1 x 8" (203mm) ferrite driver, 1.8" (45mm) voice coil HF 1 x 1" (25mm) exit, 1.75" (44mm) voice coil, advanced polymer diaphragm, ferrite compression driver				
<b>Continuous Power Handling<sup>3</sup> @ Nominal Impedance</b>	Passive*	45V	250W @ 8 ohms (1000W peak)		
<b>Autoformer Taps/Impedance IC6-1082T26   IC6-1082WT26</b>	70V 200W 100W 50W 25W	@ 70.7V 25 Ω 50 Ω 100 Ω 200 Ω	100V 200W 100W 50W	@ 100V 50 Ω 100 Ω 200 Ω	
<b>Nominal Sensitivity<sup>4</sup></b>	@ 1W/1m 94 dB	@ 2.83V 94 dB			
<b>Nominal Maximum SPL<sup>5</sup> (Whole Space)</b>	Peak 124 dB	Continuous 118 dB			
<b>Equalized Sensitivity<sup>6</sup></b>	@ 1W/1m 93 dB	@ 2.83V 93 dB			
<b>Equalized Maximum SPL<sup>7</sup></b>	Peak 123 dB	Continuous 117 dB			
<b>Recommended Amplifiers</b>	250W - 500W @ 8 ohms, (45V - 63V)				
<b>PHYSICAL</b>					
<b>Input Connection</b>	(1) Screw terminal block (5-position)				
<b>Mounting Points</b>	(7) M10 threaded inserts; (4) M8 threaded inserts (rear)				
<b>Environmental</b>	Outdoor: IP55W per IEC 60529, MIL-STD-810G				
<b>Weight</b>	Indoor IC6-1082/26   IC6-1082WR26 IC6-1082T26   IC6-1082WT26 29 lbs (13.2 kg) loudspeaker		Weather-Resistant 19.2 lbs (8.7 kg) loudspeaker 23.2 lbs (10.5 kg) loudspeaker		
<b>Dimensions H x W x D</b>	18.75" x 10.40" x 10.63" (476 x 264 x 270 mm)				
<b>Finish</b>	Refer to the Technical Drawing				
<b>OPTIONS</b>					
<b>Accessories</b>	IUB1082 U-Bracket / IVY1082 Vertical Yoke - color matched to cabinet Various third party wall, ceiling and pan/tilt mounts (refer to IC6 IUB/IVY manual for models)				
<b>Configure-to-Order (CTO)</b>	Custom color; factory-rotated horns for horizontal cabinet orientation; custom cable length for weather-resistant models				

<sup>1</sup>Rated continuous maximum input voltage at passive loudspeaker input may be higher than for directly connected transducers due to losses in the passive crossover. Voltages applied to the transducer terminals through the passive crossover shall always be the same or lower than the rated continuous voltage for each device.

Community strives to improve its products on a continual basis. Specifications are therefore subject to change without notice.



### AXIAL PROCESSED RESPONSE (dB)<sup>8</sup>

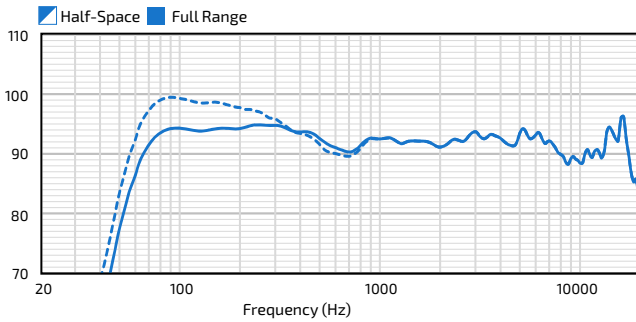

### HORIZONTAL OFF-AXIS RESPONSE (dB)<sup>10</sup>

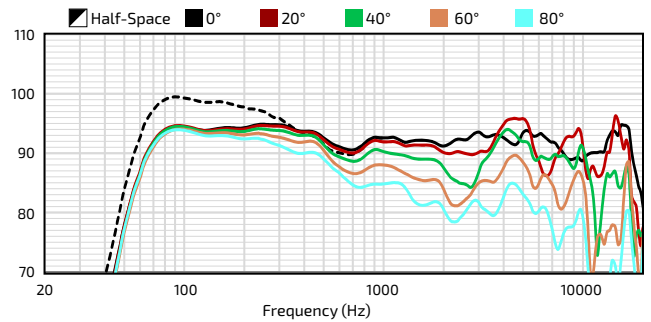

### AXIAL SENSITIVITY (dB SPL)<sup>9</sup>

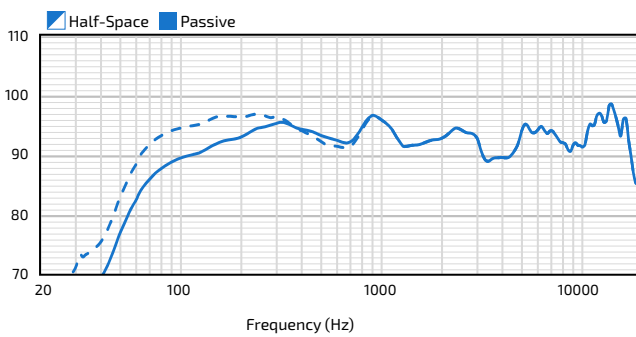

### VERTICAL OFF-AXIS UP RESPONSE (dB)<sup>10</sup>

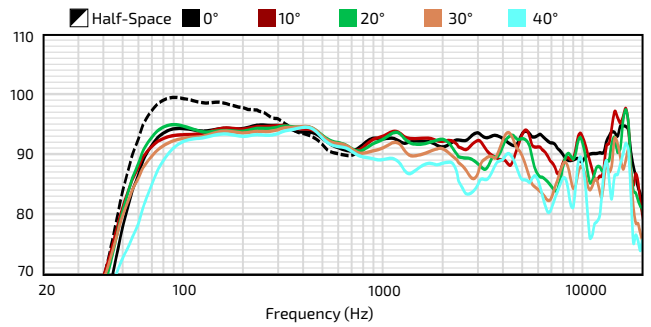

### IMPEDANCE (Ohms)

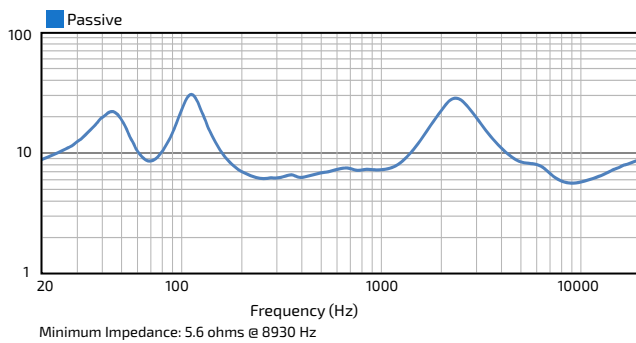

### VERTICAL OFF-AXIS DOWN RESPONSE (dB)<sup>10</sup>

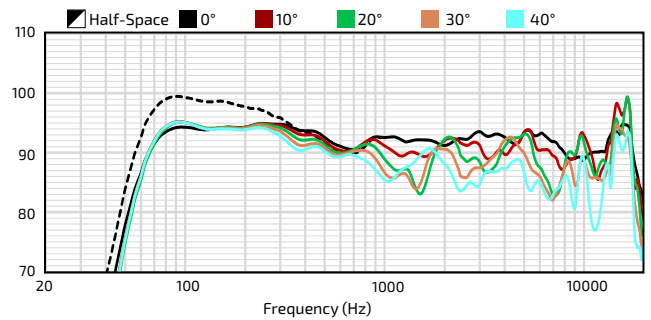

### DIRECTIVITY INDEX (dB)<sup>11</sup>

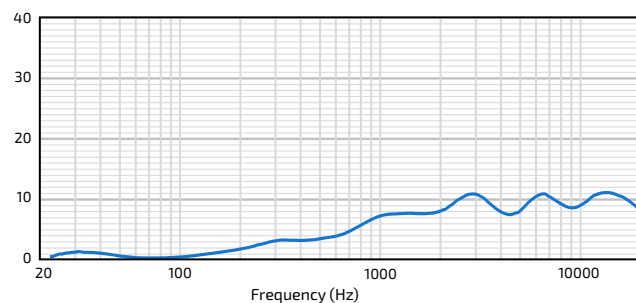

### BEAMWIDTH (Degrees)<sup>12</sup>

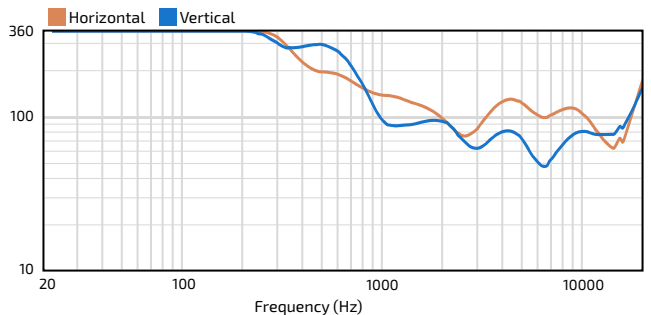



### AXIAL PROCESSED RESPONSE (dB)<sup>8</sup>

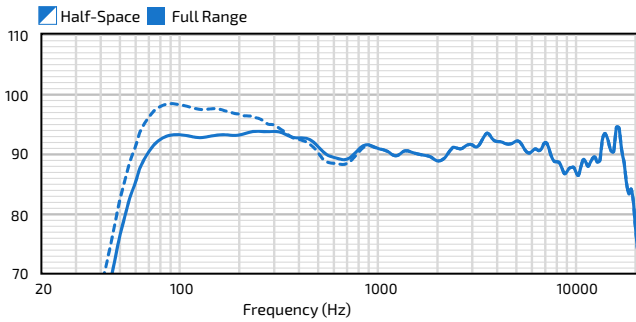

### VERTICAL OFF-AXIS RESPONSE (dB)<sup>10</sup>

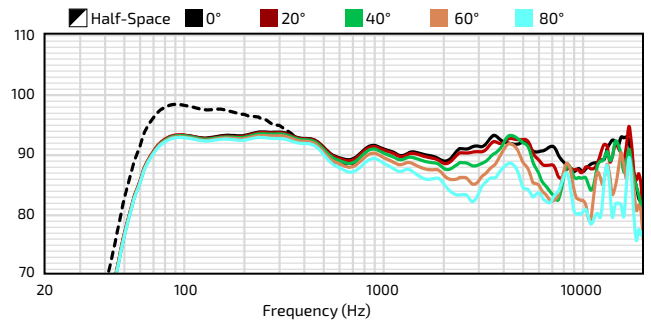

### AXIAL SENSITIVITY (dB SPL)<sup>9</sup>

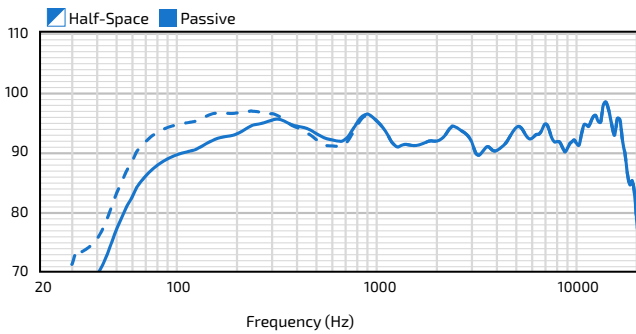

### HORIZONTAL OFF-AXIS LEFT RESPONSE (dB)<sup>10</sup>

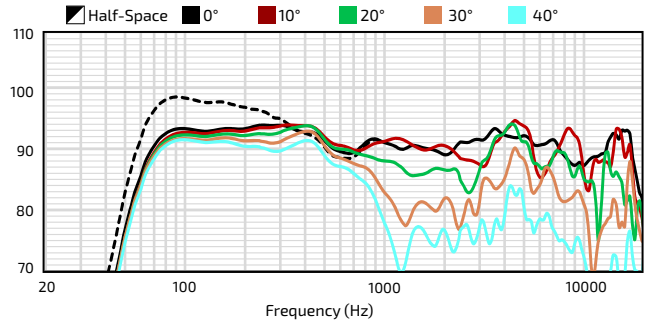

### IMPEDANCE (Ohms)

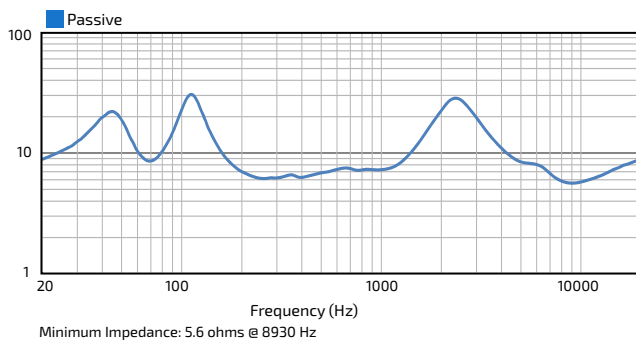

### HORIZONTAL OFF-AXIS RIGHT RESPONSE (dB)<sup>10</sup>

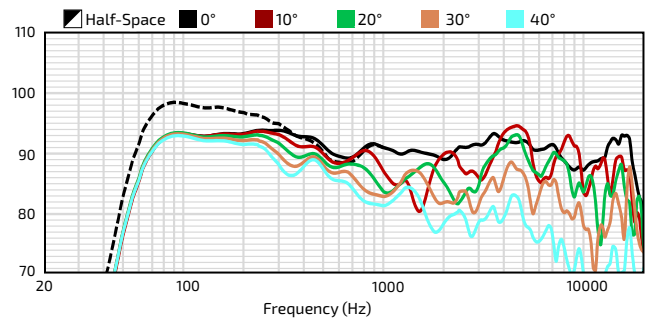

### DIRECTIVITY INDEX (dB)<sup>11</sup>

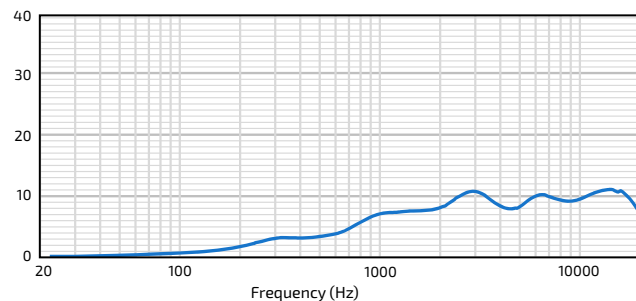

### BEAMWIDTH (Degrees)<sup>12</sup>

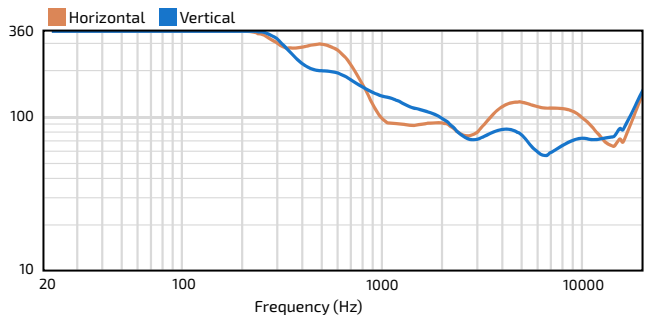

# IC6-1082/26

HIGH OUTPUT 8-INCH TWO-WAY  
120° x 60° INSTALLATION LOUDSPEAKER

(30dB Scale, 6dB per major division)

## 120° x 60° PORTRAIT CABINET

## 120° x 60° LANDSCAPE CABINET

HORIZONTAL POLAR DATA

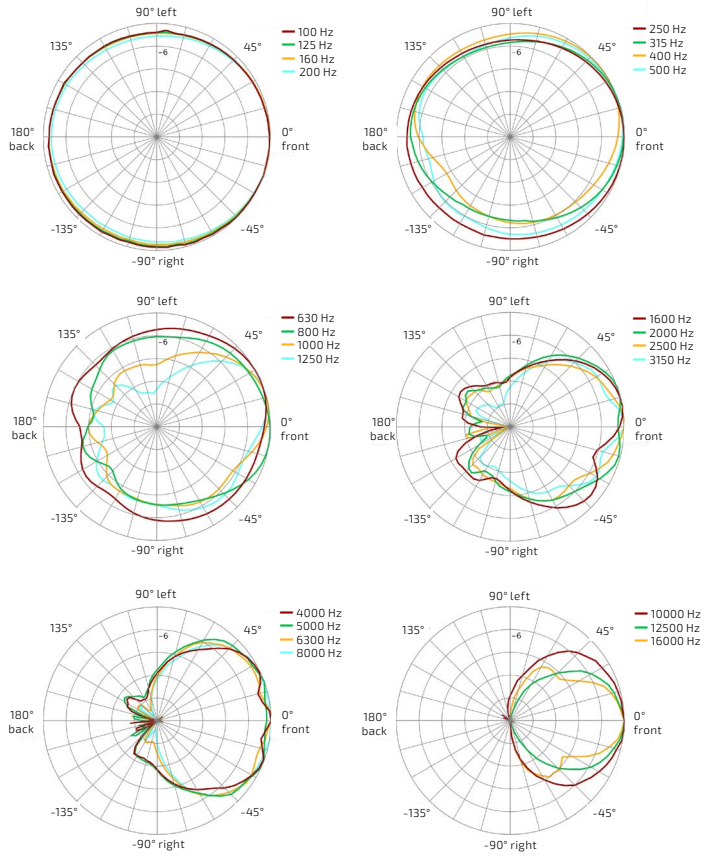
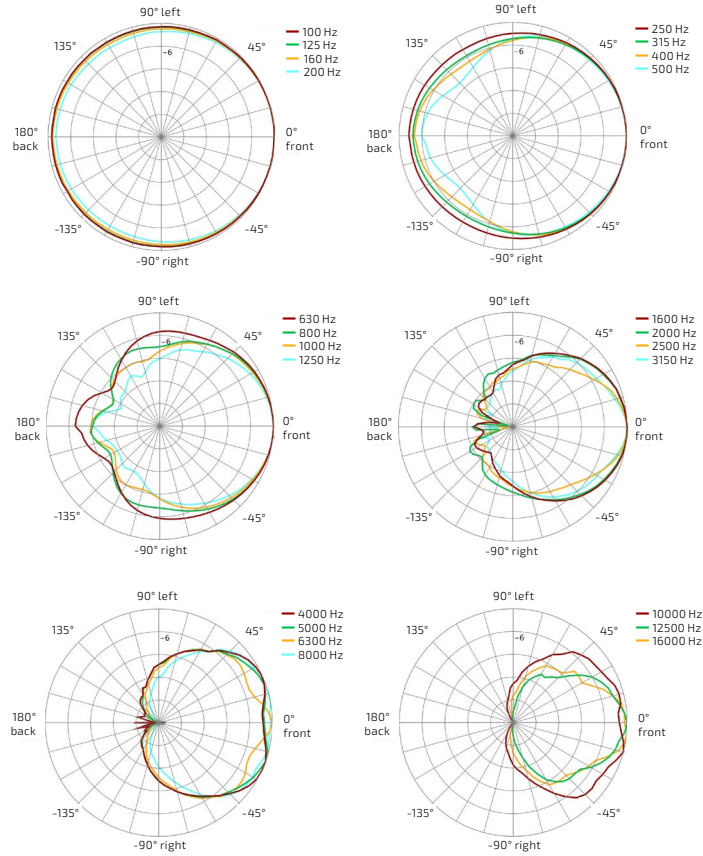

VERTICAL POLAR DATA

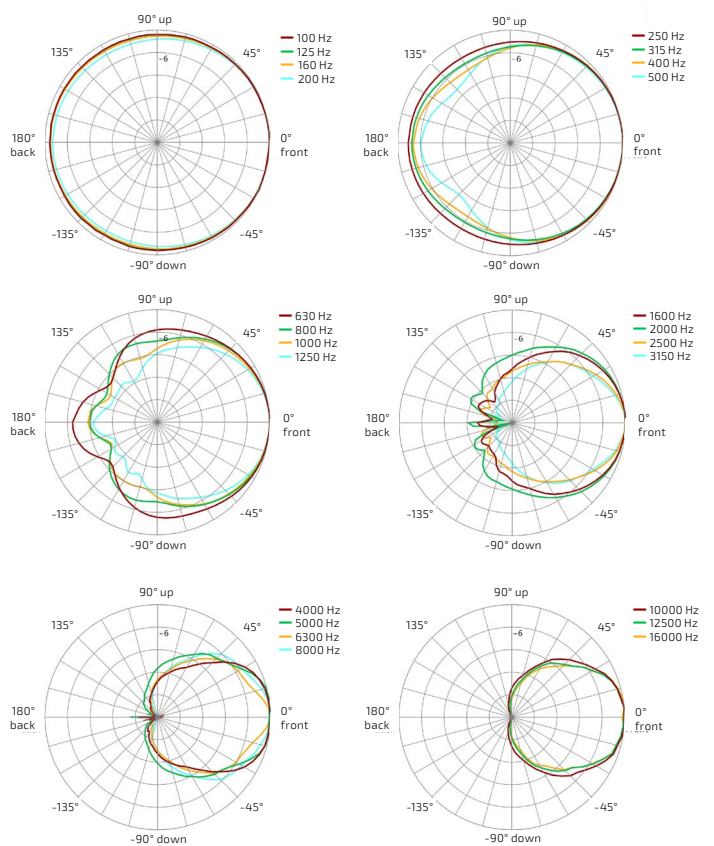
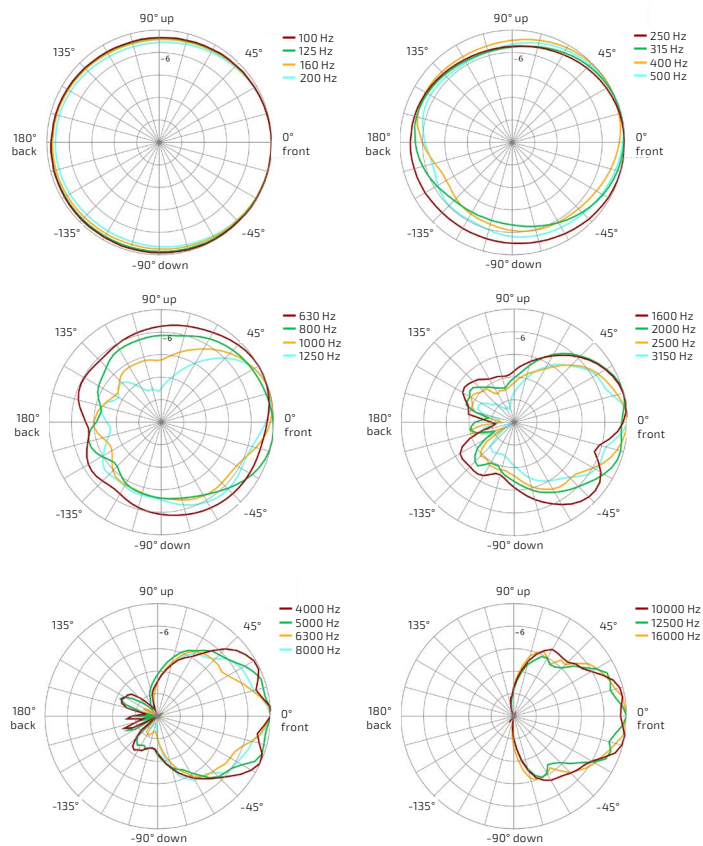

# IC6-1082/26

HIGH OUTPUT 8-INCH TWO-WAY  
120° x 60° INSTALLATION LOUDSPEAKER

## TECHNICAL DRAWING / DIMENSIONS / FINISH

**H x W x D**

18.75" x 10.40" x 10.63"  
(476 x 264 x 270 mm)

**Unit Weight**

25 lbs (11.3 kg) / IC6-1082/26 loudspeaker  
29 lbs (13.2 kg) / IC6-1082T26 loudspeaker

**Shipping Weight**

30 lbs (13.5 kg) / IC6-1082/26 loudspeaker  
34 lbs (15.3 kg) / IC6-1082T26 loudspeaker

**Indoor Models:**

**Grille:** Powder-coated perforated steel backed with color-matched acoustically transparent woven fabric. Black (RAL#9005) or White (RAL#9003)

**Enclosure / Finish:** Black (RAL#9005) or White (RAL#9003) low gloss, uniformly textured painted 15mm Baltic Birch plywood.

**Outdoor Models:**

**Grille:** Marine grade aluminum with zinc-rich dual-layer powder-coat, featuring hydrophobic treatment on acoustically transparent woven black fabric backing.

**Enclosure / Finish:** 15mm PolyGlas™, Grey (RAL#7038), heavily textured industrial-grade exterior-rated coating.

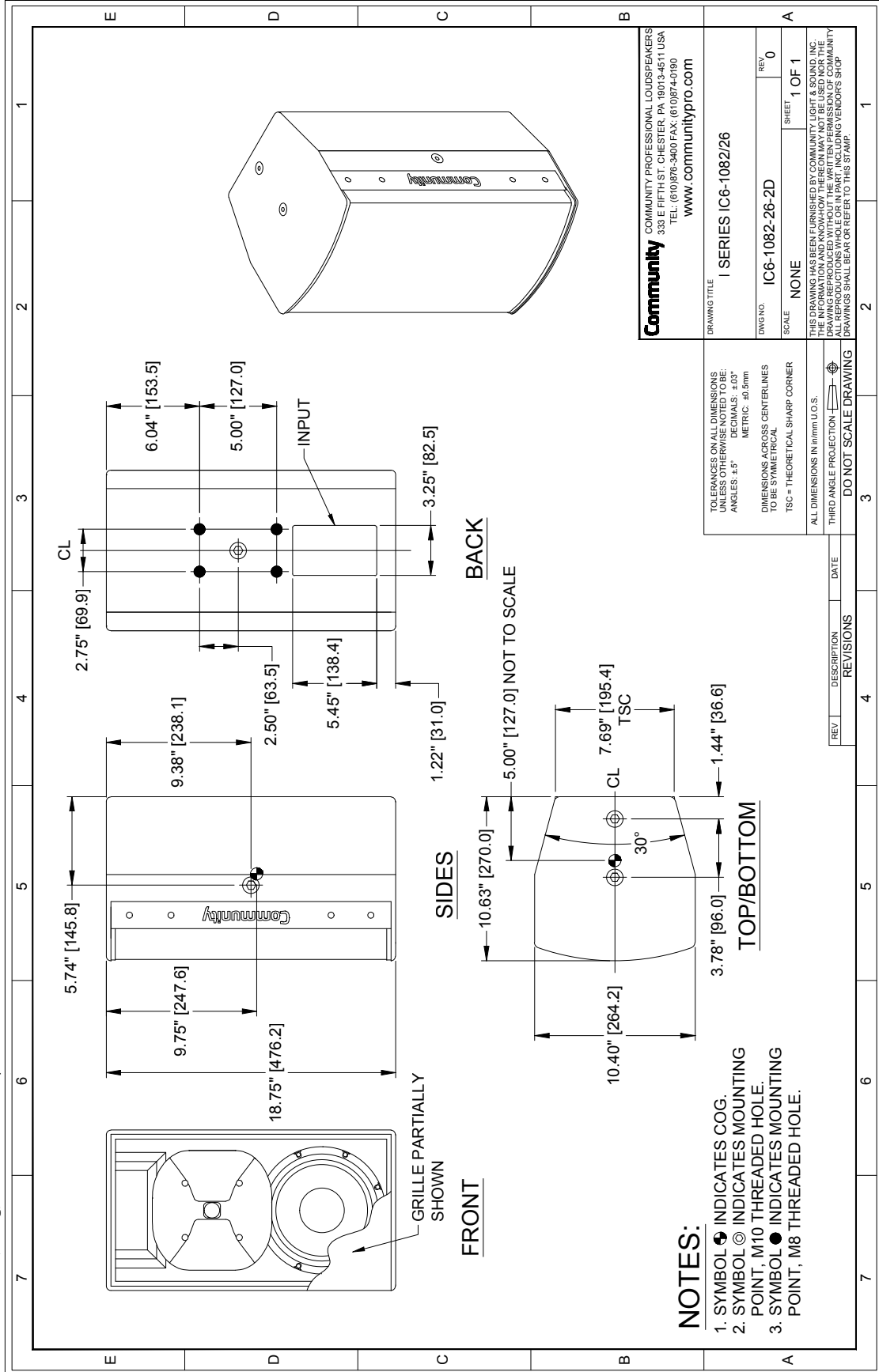

**NOTES:**

1. SYMBOL ● INDICATES COG.
2. SYMBOL ⊙ INDICATES MOUNTING POINT, M10 THREADED HOLE.
3. SYMBOL ⊙ INDICATES MOUNTING POINT, M8 THREADED HOLE.

\*Note: The transformer and outdoor model drawings are available at communitypro.com  
On the WR/WT models the input connection differs and the units weigh less than their respective indoor models

## I SERIES Compact 600

# IC6-1082/26

HIGH OUTPUT 8-INCH TWO-WAY  
120° x 60° INSTALLATION LOUDSPEAKER

### CONNECTION DIAGRAMS

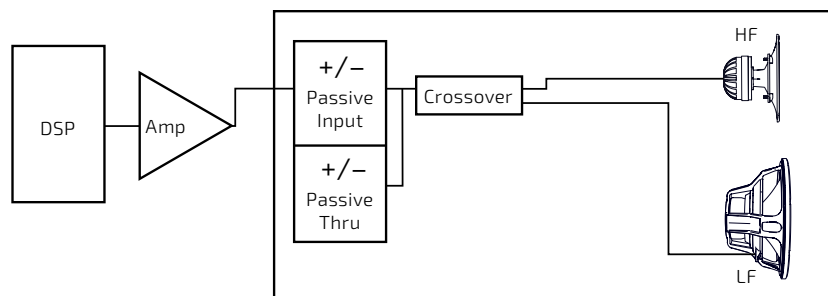

Two-way single amp

### WEATHER-RESISTANT INPUT CABLE

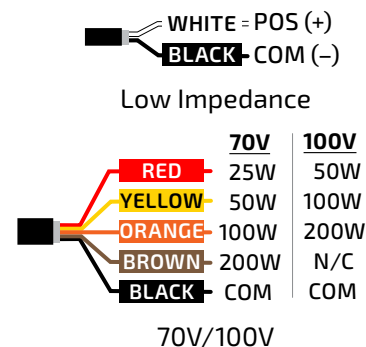

Low Impedance Input Panel (Indoor)

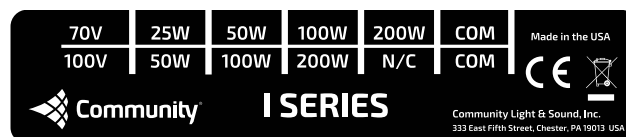

70V / 100V Input Panel (Indoor)

### NOTES

- PERFORMANCE SPECIFICATIONS** All measurements are taken indoor using a time-windowed and processed signal to eliminate room effects, approximating an anechoic environment, a distance of 6.0 m. All acoustic specifications are rounded to the nearest whole number. An external DSP with settings provided by Community Professional Loudspeakers is required to achieve the specified performance; further performance gains can be realized using Community's dSPEC226 loudspeaker processor with FIR power response optimization.
- OPERATING RANGE** The frequency range in which the on-axis processed response remains within 10dB of the average SPL.
- CONTINUOUS POWER HANDLING** Maximum continuous input voltage (and the equivalent power rating, in watts, at the stated nominal impedance) that the system can withstand, without damage, for a period of 2 hours using an EIA-426-B defined spectrum; with recommended signal processing and protection filters.
- NOMINAL SENSITIVITY** Averaged SPL over the operating range with an input voltage that would produce 1 Watt at the nominal impedance and the averaged SPL over the operating range with a fixed input voltage of 2.83V, respectively; swept sine wave axial measurements with no external processing applied in whole space, except where indicated.
- NOMINAL MAXIMUM SPL** Calculated based on nominal / peak power handling, respectively, and nominal sensitivity; exclusive of power compression.
- EQUALIZED SENSITIVITY** The respective SPL levels produced when an EIA-426-B signal is applied to the equalized loudspeaker system at a level which produces a total power of 1 Watt, in sum, to the loudspeaker subsections and also at a level which produces a total voltage, in sum, of 2.83V to the loudspeaker subsections, respectively; each referenced to a distance of 1 meter.
- EQUALIZED MAXIMUM SPL** The SPL produced when an EIA-426-B signal is applied to the equalized loudspeaker system, at a level which drives at least one subsection to its rated continuous input voltage limit, referenced to a distance of 1 meter. The peak SPL represents the 2:1 (6dB) crest factor of the EIA-426-B test signal.
- AXIAL PROCESSED RESPONSE** The on-axis variation in acoustic output level with frequency of the complete loudspeaker system with recommended signal processing applied. 1/6 octave Gaussian smoothing applied.
- AXIAL SENSITIVITY** The on-axis variation in acoustic output level with frequency for a 1 Watt swept sine wave, referenced to 1 meter with no signal processing. 1/6 octave Gaussian smoothing applied.
- HORIZONTAL / VERTICAL OFF-AXIS RESPONSES** The loudspeaker's magnitude response at various angles off-axis, with recommended signal processing applied in the operating mode which utilizes the largest number of individually amplified pass bands. 1/6 octave Gaussian smoothing applied.
- DIRECTIVITY INDEX** The ratio of the on-axis SPL squared to the mean squared SPL at the same distance for all points within the measurement sphere for each given frequency; expressed in dB. 1/6 octave Gaussian smoothing applied.
- BEAMWIDTH** The angle between the -6dB points in the polar response of the loudspeaker when driven in the operating mode which utilizes the largest number of individually amplified pass bands. 1/6 octave Gaussian smoothing applied.

Data presented on this spec sheet represents a selection of the basic performance specifications for the IC6-1082. These specifications are intended to allow the user to perform a fair, straightforward evaluation and comparison with other loudspeaker spec sheets. For a detailed analysis of this loudspeaker's performance, please download the GLL file and/or the CLF file from our website: [communitypro.com](http://communitypro.com)