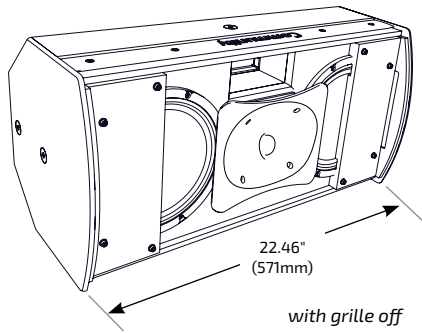

**I SERIES**  
 Compact 600

# IC6-2082/96

 HIGH OUTPUT DUAL 8-INCH TWO-WAY  
 90° x 60° INSTALLATION LOUDSPEAKER

**APPLICATIONS**
**MAIN PA or DISTRIBUTED**

 Restaurants · Presentation Suites · Auditoriums  
 Retail Spaces · Smaller Houses of Worship · Stadiums  
 Theme Parks · Cruise Ships · Entrance Halls

**FILL or DELAY**

 Houses of Worship · Auditoriums · Arenas · Stadiums  
 Theaters · Themed Entertainment · Under Balcony  
 Stage Lip Fill

**DESCRIPTION**

I SERIES Compact 600 loudspeakers provide excellent acoustic performance, flexibility and elegant aesthetics for a diverse range of applications in today's performance venues. Designed to support the goals of systems integrators and consultants in need of very compact loudspeakers with exceptional near field fidelity for foreground or background music applications and articulate voice projection with very high output capabilities for fill and distributed applications. I SERIES Compact loudspeakers are engineered to be used alone or integrated into arrays along with I SERIES Point Source (IP) or Subwoofer (IS) models using the comprehensive selection of available BalancePoint™ Flyware modular array brackets.

The IC6-2082/96 is designed for demanding extended high output, high performance applications without sacrificing fidelity or coverage consistency. Most symmetrical dual 8" 2-way loudspeakers suffer from serious coverage inconsistencies through the crossover region. The IC6-2082/96 solves this problem by using a very high quality, low distortion 1.7" diaphragm neodymium HF compression driver on a large field-rotatable horn that is crossed over to partially baffled 8" LF drivers at an unusually low crossover frequency. The combination of baffles and low crossover point allows the IC6-2082/96 to perform similarly to a coaxial loudspeaker, resulting in a consistent, symmetrical, and wide coverage pattern through its operating range. The long excursion LF drivers and low velocity port effortlessly extend LF performance at any output level. Additionally, 16 ohm or 70V/100V models expand application flexibility both indoors and out. Multiple attachment points provide compatibility with a variety of Community and third party mounting brackets.

**FEATURES**

- Engineered for demanding high output, high performance applications
- Exceptional fidelity with elegant I SERIES aesthetics
- Large, field-rotatable HF horn and LF pattern control technology for wide, consistent coverage
- Low impedance (16 ohm) or 70V/100V models available
- Low profile U-Bracket or Vertical Yoke available, compatible with most third party wall and ceiling brackets

**TECHNICAL SPECIFICATIONS<sup>1</sup>**

<b>Operating Mode</b>	Low Impedance or 70V/100V models				
<b>Operating Environment</b>	Indoor or Weather-Resistant Outdoor				
<b>Operating Range<sup>2</sup></b>	49 Hz to 19.5 kHz				
<b>Nominal Beamwidth (H x V)</b>	90° x 60°, rotatable waveguide				
<b>Transducers</b>	LF 2 x 8" (203mm) ferrite driver, 1.5" (37mm) voice coil HF 1 x 1" (25mm) exit, 1.7" (44mm) voice coil, ketone polymer diaphragm, neodymium compression driver				
<b>Continuous Power Handling<sup>3</sup> @ Nominal Impedance</b>	Passive*	69V	300W @ 16 ohms (1200W peak)		
<b>Autotformer Taps/Impedance</b> IC6-2082T96   IC6-2082WT96	70V 200W 100W 50W 25W	@ 70.7V 25 Ω 50 Ω 100 Ω 200 Ω	100V 200W 100W 50W	@ 100V 50 Ω 100 Ω 200 Ω	
<b>Nominal Sensitivity<sup>4</sup></b>	@ 1W/1m 99 dB	@ 2.83V 96 dB			
<b>Nominal Maximum SPL<sup>5</sup> (Whole Space)</b>	Peak 130 dB	Continuous 124 dB			
<b>Equalized Sensitivity<sup>6</sup></b>	@ 1W/1m 98 dB	@ 2.83V 95 dB			
<b>Equalized Maximum SPL<sup>7</sup></b>	Peak 129 dB	Continuous 123 dB			
<b>Recommended Amplifiers</b>	300W - 600W @ 16 ohms, (69V - 98V)				
<b>PHYSICAL</b>					
<b>Input Connection</b>	(1) Screw terminal block (5-position)				
<b>Mounting Points</b>	(9) M10 threaded inserts; (4) M8 threaded inserts (rear)				
<b>Environmental</b>	Outdoor: IP55W per IEC 60529, MIL-STD-810G				
<b>Weight</b>	Indoor 31 lbs (14.1 kg) loudspeaker 35 lbs (15.9 kg) loudspeaker		Weather-Resistant 23.9 lbs (10.8 kg) loudspeaker 27.9 lbs (12.7 kg) loudspeaker		
<b>Dimensions H x W x D</b>	11.30" x 22.46" x 10.62" (287 x 571 x 270 mm)				
<b>Finish</b>	Refer to the Technical Drawing				
<b>OPTIONS</b>					
<b>Accessories</b>	IUB2082 U-Bracket / IVY2082 Vertical Yoke - color matched to cabinet Various third party wall, ceiling and pan/tilt mounts (refer to IC6 IUB/IVY manual for models)				
<b>Configure-to-Order (CTO)</b>	Custom color; factory-rotated horns for vertical cabinet orientation; custom cable length for weather-resistant models				

<sup>1</sup>Rated continuous maximum input voltage at passive loudspeaker input may be higher than for directly connected transducers due to losses in the passive crossover. Voltages applied to the transducer terminals through the passive crossover shall always be the same or lower than the rated continuous voltage for each device.



### AXIAL PROCESSED RESPONSE (dB)<sup>8</sup>

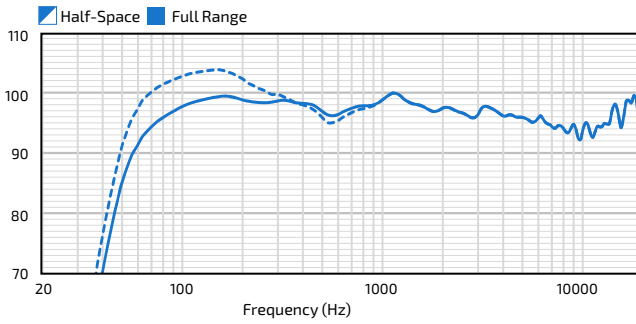

### HORIZONTAL OFF-AXIS RESPONSE (dB)<sup>10</sup>

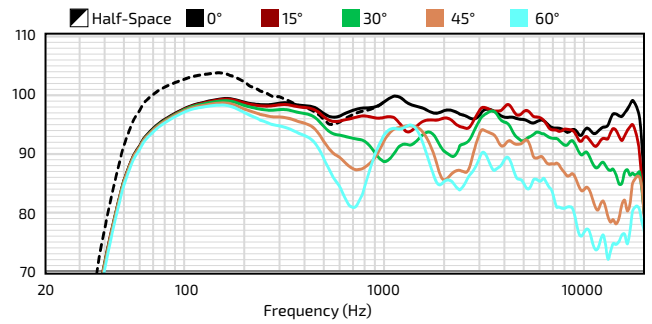

### AXIAL SENSITIVITY (dB SPL)<sup>9</sup>

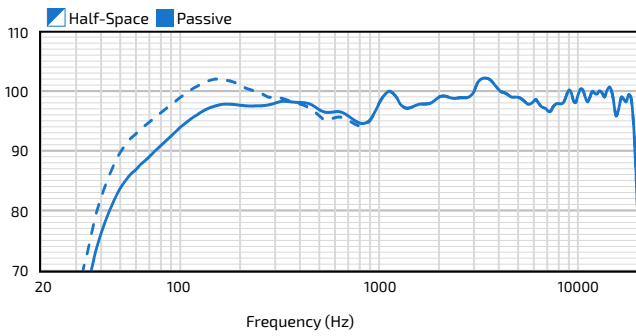

### VERTICAL OFF-AXIS UP RESPONSE (dB)<sup>10</sup>

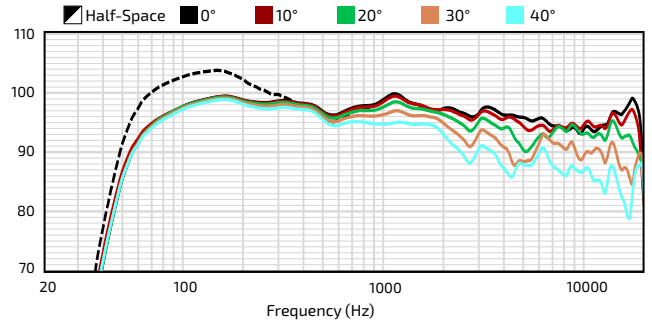

### IMPEDANCE (Ohms)

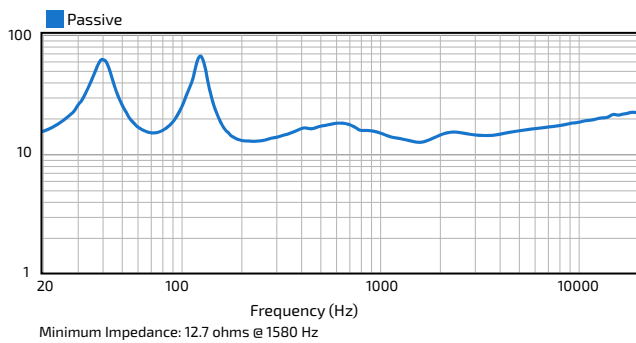

### VERTICAL OFF-AXIS DOWN RESPONSE (dB)<sup>10</sup>

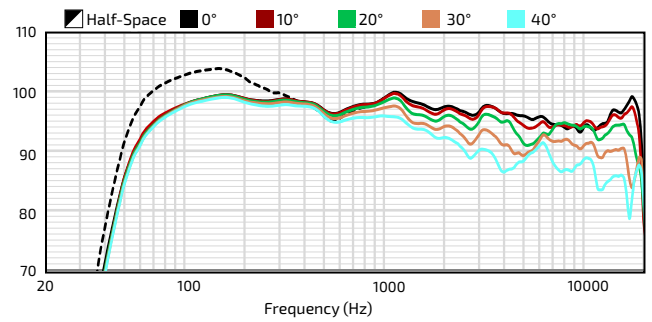

### DIRECTIVITY INDEX (dB)<sup>11</sup>

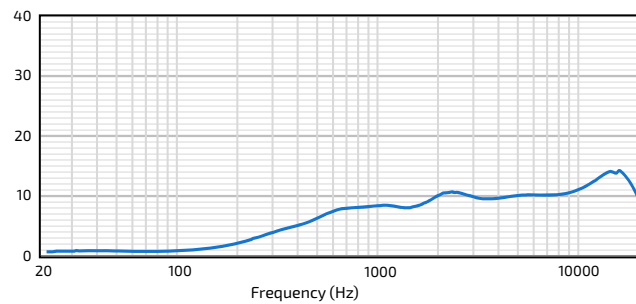

### BEAMWIDTH (Degrees)<sup>12</sup>

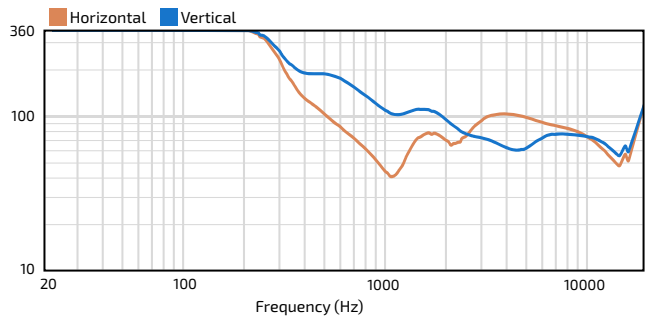



### AXIAL PROCESSED RESPONSE (dB)<sup>8</sup>

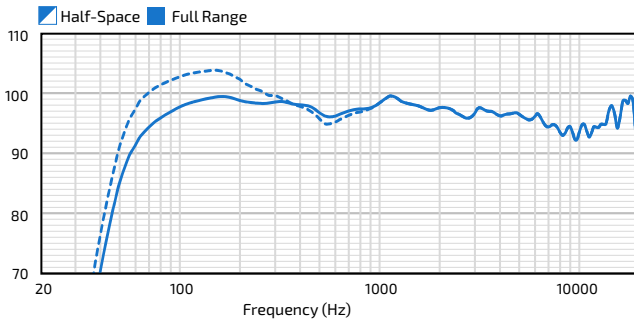

### VERTICAL OFF-AXIS RESPONSE (dB)<sup>10</sup>

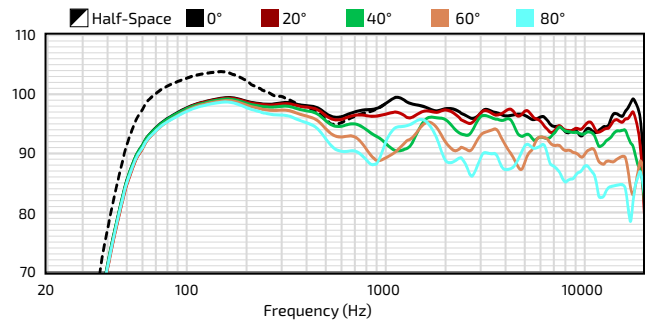

### AXIAL SENSITIVITY (dB SPL)<sup>9</sup>

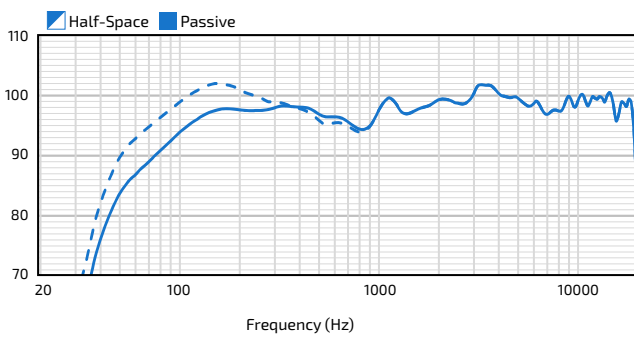

### HORIZONTAL OFF-AXIS LEFT RESPONSE (dB)<sup>10</sup>

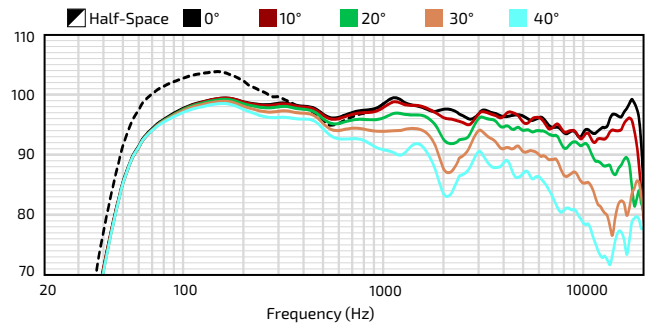

### IMPEDANCE (Ohms)

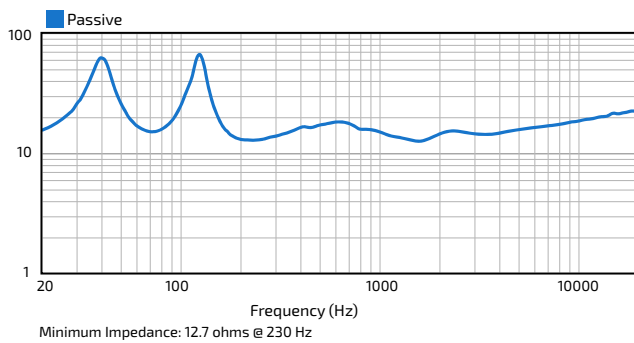

### HORIZONTAL OFF-AXIS RIGHT RESPONSE (dB)<sup>10</sup>

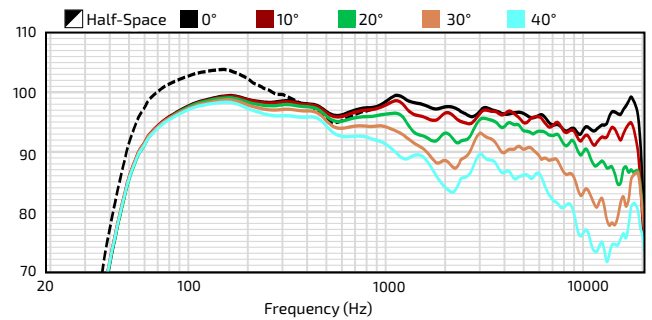

### DIRECTIVITY INDEX (dB)<sup>11</sup>

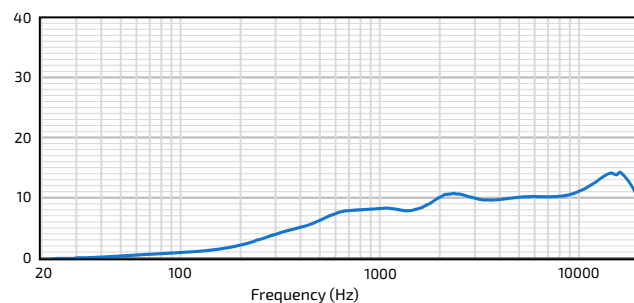

### BEAMWIDTH (Degrees)<sup>12</sup>

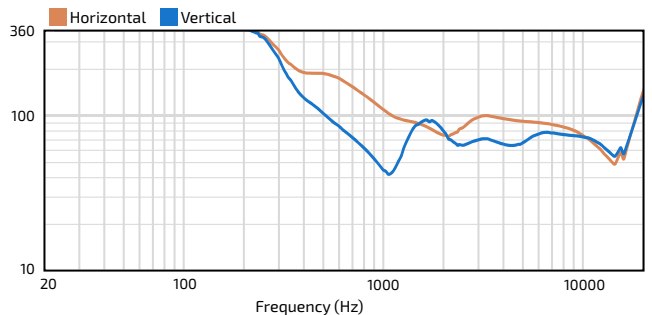

# IC6-2082/96

HIGH OUTPUT DUAL 8-INCH TWO-WAY  
90° x 60° INSTALLATION LOUDSPEAKER

(30dB Scale, 6dB per major division)

## 90° x 60° PORTRAIT CABINET

## 90° x 60° LANDSCAPE CABINET

HORIZONTAL POLAR DATA

VERTICAL POLAR DATA

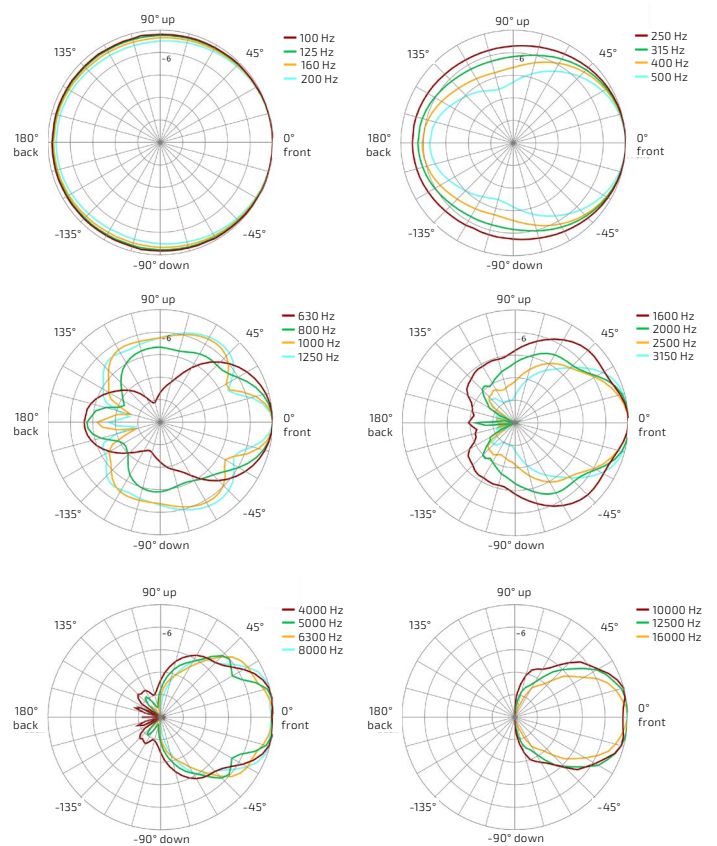
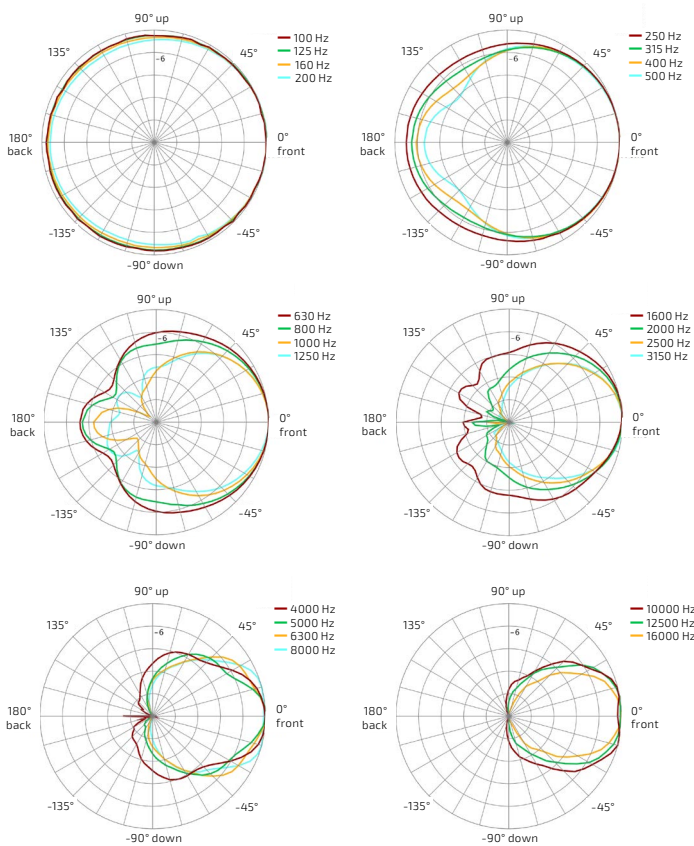
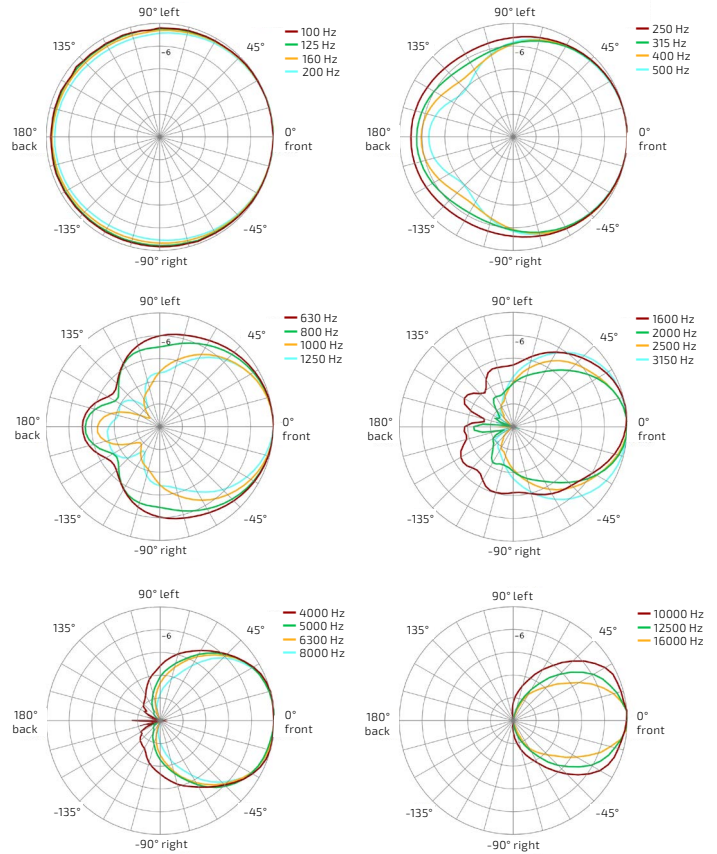
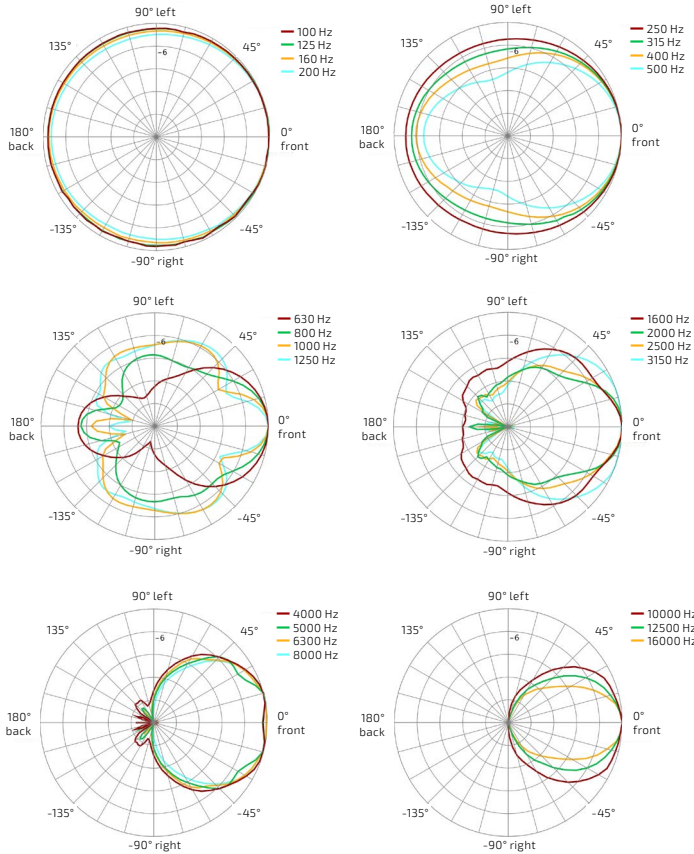

# IC6-2082/96 HIGH OUTPUT DUAL 8-INCH TWO-WAY 90° x 60° INSTALLATION LOUDSPEAKER

## TECHNICAL DRAWING / DIMENSIONS / FINISH

**H x W x D**

11.30" x 22.46" x 10.62"  
(287 x 571 x 270 mm)

**Unit Weight**

31 lbs (14.1 kg) IC6-2082/26 loudspeaker  
35 lbs (15.9 kg) IC6-2082T26 loudspeaker

**Shipping Weight**

35.6 lbs (16.1 kg) IC6-2082/96 loudspeaker  
39.6 lbs (18.0 kg) IC6-2082T96 loudspeaker

**Indoor Models:**

**Grille:** Powder-coated perforated steel backed with color-matched acoustically transparent woven fabric. Black (RAL#9005) or White (RAL#9003)

**Enclosure / Finish:** Black (RAL#9005) or White (RAL#9003) low gloss, uniformly textured painted 15mm Baltic Birch plywood.

**Outdoor Models:**

**Grille:** Marine grade aluminum with zinc-rich dual-layer powder-coat, featuring hydrophobic treatment on acoustically transparent woven black fabric backing.

**Enclosure / Finish:** 15mm PolyGlas™, Grey (RAL#7038), heavily textured industrial-grade exterior-rated coating.

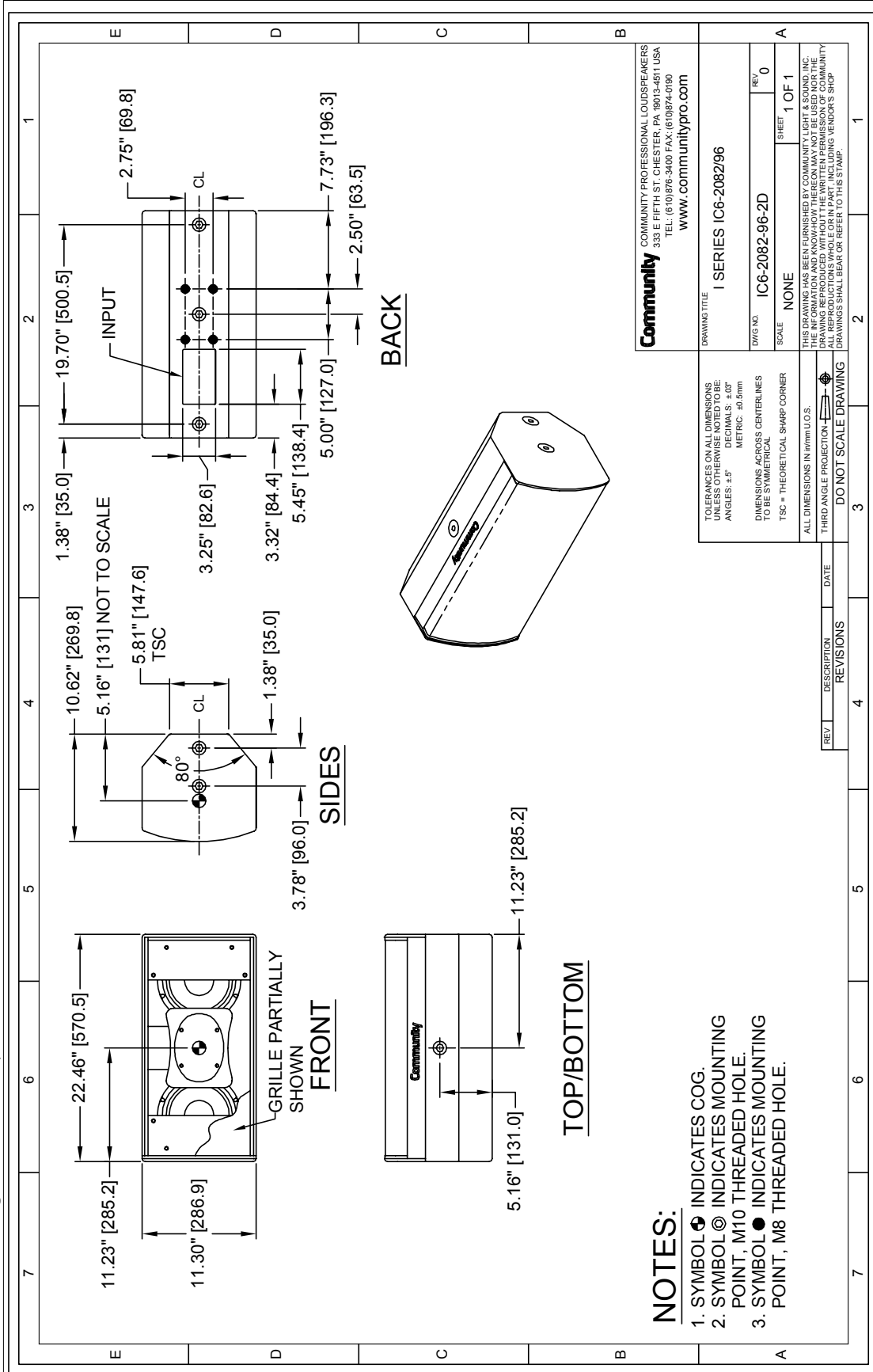

<b>Community</b> COMMUNITY PROFESSIONAL LOUDSPEAKERS 333 E FIFTH ST. CHESTER, PA 19013-4911 USA TEL: (610)976-3400 FAX: (610)974-0190 www.communitypro.com	
DRAWING TITLE	I SERIES IC6-2082/96
DWG NO	IC6-2082-96-2D
SCALE	NONE
SHEET	1 OF 1
REV	0

TOLERANCES ON ALL DIMENSIONS UNLESS OTHERWISE SPECIFIED:
DECIMALS: ±.015"
ANGLES: ±.5°
METRIC: ±0.5mm
DIMENSIONS ACROSS CENTERLINES TO BE SYMMETRICAL
TSC = THEORETICAL SHARP CORNER
ALL DIMENSIONS IN INCHES U.S.
THIRD ANGLE PROJECTION
DO NOT SCALE DRAWING

REV	DESCRIPTION	DATE

\*Note: The transformer and outdoor model drawings are available at communitypro.com  
On the WR/WT models the input connection differs and the units weigh less than their respective indoor models



## I SERIES Compact 600

# IC6-2082/96

HIGH OUTPUT DUAL 8-INCH TWO-WAY  
90° x 60° INSTALLATION LOUDSPEAKER

### CONNECTION DIAGRAMS

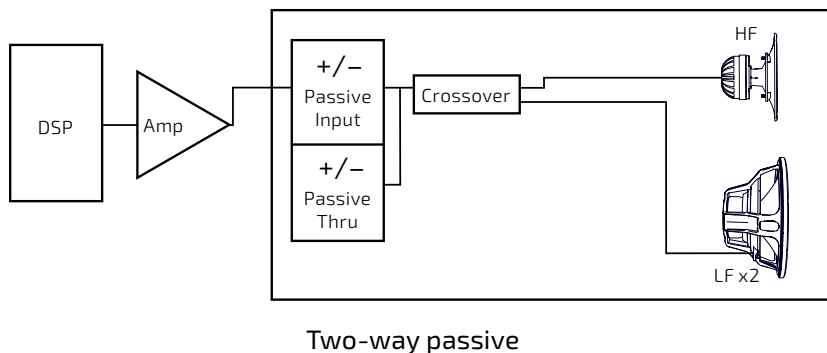

### WEATHER-RESISTANT INPUT CABLE

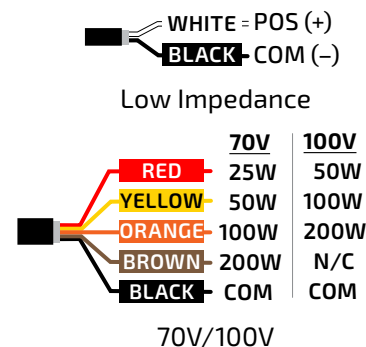

Low Impedance Input Panel (Indoor)

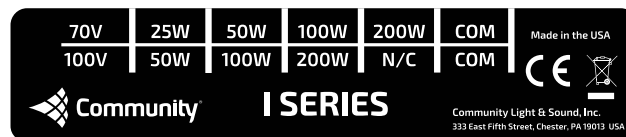

70V / 100V Input Panel (Indoor)

### NOTES

- PERFORMANCE SPECIFICATIONS** All measurements are taken indoor using a time-windowed and processed signal to eliminate room effects, approximating an anechoic environment, a distance of 6.0 m. All acoustic specifications are rounded to the nearest whole number. An external DSP with settings provided by Community Professional Loudspeakers is required to achieve the specified performance; further performance gains can be realized using Community's dSPEC226 loudspeaker processor with FIR power response optimization.
- OPERATING RANGE** The frequency range in which the on-axis processed response remains within 10dB of the average SPL.
- CONTINUOUS POWER HANDLING** Maximum continuous input voltage (and the equivalent power rating, in watts, at the stated nominal impedance) that the system can withstand, without damage, for a period of 2 hours using an EIA-426-B defined spectrum; with recommended signal processing and protection filters.
- NOMINAL SENSITIVITY** Averaged SPL over the operating range with an input voltage that would produce 1 Watt at the nominal impedance and the averaged SPL over the operating range with a fixed input voltage of 2.83V, respectively; swept sine wave axial measurements with no external processing applied in whole space, except where indicated.
- NOMINAL MAXIMUM SPL** Calculated based on nominal / peak power handling, respectively, and nominal sensitivity; exclusive of power compression.
- EQUALIZED SENSITIVITY** The respective SPL levels produced when an EIA-426-B signal is applied to the equalized loudspeaker system at a level which produces a total power of 1 Watt, in sum, to the loudspeaker subsections and also at a level which produces a total voltage, in sum, of 2.83V to the loudspeaker subsections, respectively; each referenced to a distance of 1 meter.
- EQUALIZED MAXIMUM SPL** The SPL produced when an EIA-426-B signal is applied to the equalized loudspeaker system, at a level which drives at least one subsection to its rated continuous input voltage limit, referenced to a distance of 1 meter. The peak SPL represents the 2:1 (6dB) crest factor of the EIA-426-B test signal.
- AXIAL PROCESSED RESPONSE** The on-axis variation in acoustic output level with frequency of the complete loudspeaker system with recommended signal processing applied. 1/6 octave Gaussian smoothing applied.
- AXIAL SENSITIVITY** The on-axis variation in acoustic output level with frequency for a 1 Watt swept sine wave, referenced to 1 meter with no signal processing. 1/6 octave Gaussian smoothing applied.
- HORIZONTAL / VERTICAL OFF-AXIS RESPONSES** The loudspeaker's magnitude response at various angles off-axis, with recommended signal processing applied in the operating mode which utilizes the largest number of individually amplified pass bands. 1/6 octave Gaussian smoothing applied.
- DIRECTIVITY INDEX** The ratio of the on-axis SPL squared to the mean squared SPL at the same distance for all points within the measurement sphere for each given frequency; expressed in dB. 1/6 octave Gaussian smoothing applied.
- BEAMWIDTH** The angle between the -6dB points in the polar response of the loudspeaker when driven in the operating mode which utilizes the largest number of individually amplified pass bands. 1/6 octave Gaussian smoothing applied.

Data presented on this spec sheet represents a selection of the basic performance specifications for the IC6-2082. These specifications are intended to allow the user to perform a fair, straightforward evaluation and comparison with other loudspeaker spec sheets. For a detailed analysis of this loudspeaker's performance, please download the GLL file and/or the CLF file from our website: [communitypro.com](http://communitypro.com)