

DM8000 DSP Designer Software

Advanced Digital Audio Processor for Installation Applications with Configurable DSP, Audio Networking and Acoustic Echo Cancellation

Table of Contents

1. Installation	3
1.1 System Requirements.....	3
1.2 Installation Procedure.....	3
2. Software Interface Overview	3
2.1 Basic Screen Elements.....	3
3. Module Library	12
3.1 Input Output Modules	12
3.2 Mixers.....	15
3.3 Equalisers.....	19
3.4 Filters.....	21
3.5 CrossOvers	23
3.6 Dynamics.....	23
3.7 Routers	27
3.8 Delays	28
3.9 Controls.....	28
3.10 Meters.....	36
3.11 Generators.....	38
4. Building a Signal Processing Architecture.....	39
4.1 Deploying Component Objects	40
5. Operation	41
5.1 Networking	41
5.2 System Security.....	41
5.3 Third Party Control.....	43
6. Index.....	58

LIMITED WARRANTY

For the applicable warranty terms and conditions and additional information regarding MUSIC Group's Limited Warranty, please see complete details online at music-group.com/warranty.

1. Installation

1.1 System Requirements

Minimum Hardware	
PC-based Hardware	-Core 2 DUO CPU -Ethernet port
	-1 GB RAM
Recommended Operating Systems	
Windows*	-Windows 7, 32-bit or 64-bit -Windows 8, 32-bit or 64 bit

* Windows is either a registered trademark or trademark of Microsoft Corporation in the United States and/or other countries.

A PC computer running DM8000 DSP Designer Software with Windows® operating systems must have a 10/100 BaseT network card (NIC) installed.

Ethernet switches must be 10/100 BaseT compatible, with sufficient ports for connection to each DM8000 unit (multiple switches may be used).

For more information about DM8000 networking see "Networking" on pgs. 38-39.

1.2 Installation Procedure

To install the DM8000 DSP Designer software:

1. Go to the DM8000 product page at <http://www.music-group.com/brand/klarkteknik>.
2. Click on the Downloads tab.
3. Click on the download icon for the latest version of the DM8000 DSP Designer software.
4. Read the software End User License Agreement and click on "Agree".
5. Click on "Download".
6. Click on the downloaded .exe file and follow the installation instructions.

2. Software Interface Overview

2.1 Basic Screen Elements

The DM8000 DSP Designer software deploys an interface structure similar to software geared toward visual design, with standard pulldown menus, toolbars and libraries.

2.1.1 Main Screen

Here is the **Main Screen** you should see when you open and load the software:

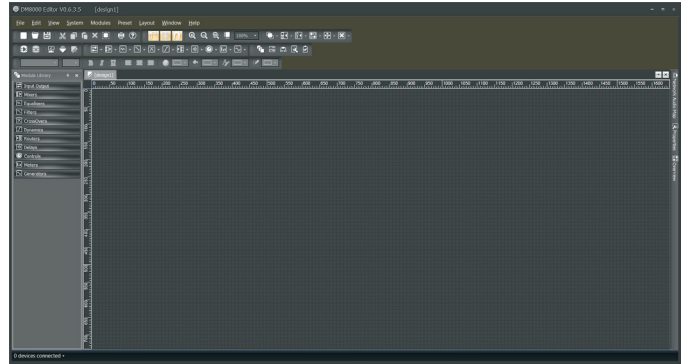

DM8000 Main Screen

The main screen of the DM8000 software has several sections:

2.1.2 Build Window

The **Build Window** occupies the largest portion of the main screen, at the lower-right. This is the area where system design actually occurs, with the placement and connection of Component Objects.

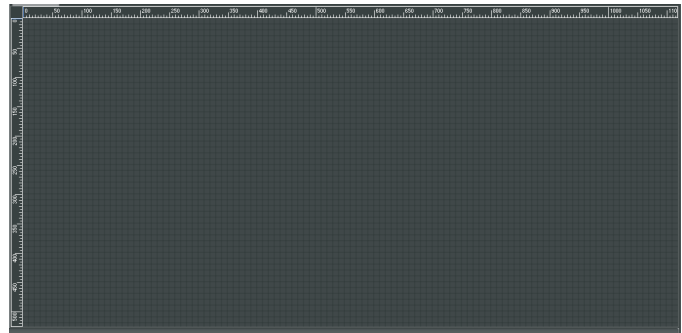

DM8000 Build Window

2.1.3 Component Objects

Component Objects represent the individual hardware devices and signal processing elements contained within processing Modules. Component Objects appear specifically within the Build Window whenever a processing Module is dragged in and placed within the Build Window.

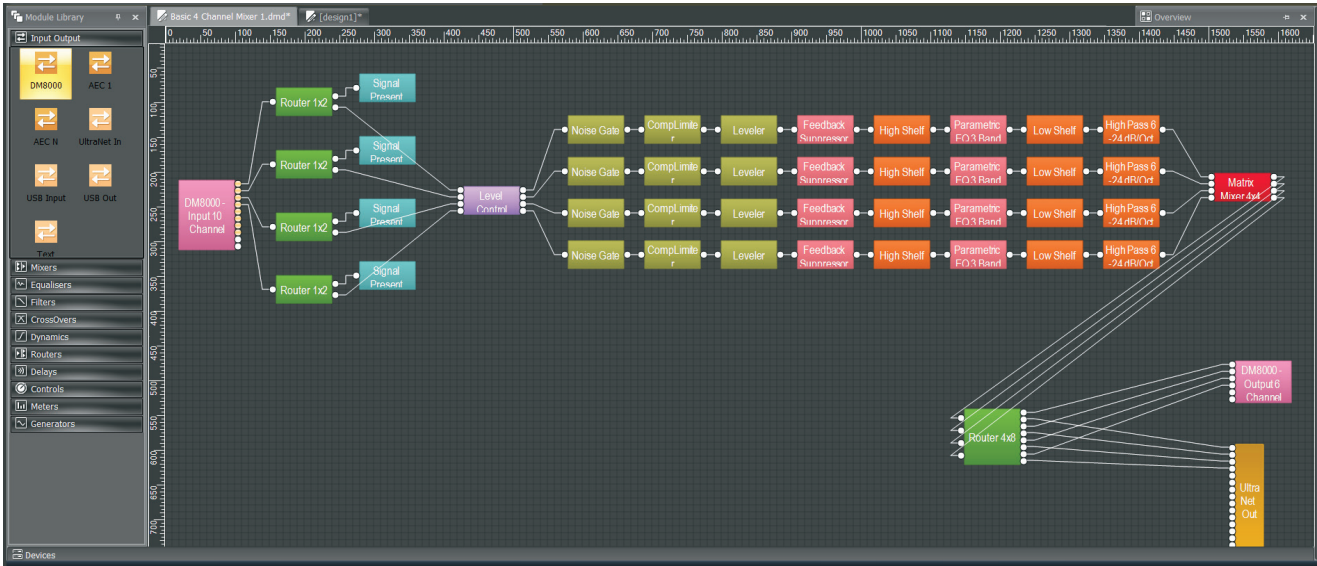

Build Window with Component Objects

2.1.4 Overview Screen

The **Overview Screen** is available to aid navigation if a system becomes too big to fit inside the available Build Screen space (the Overview Screen is on the right side of the Main Screen).

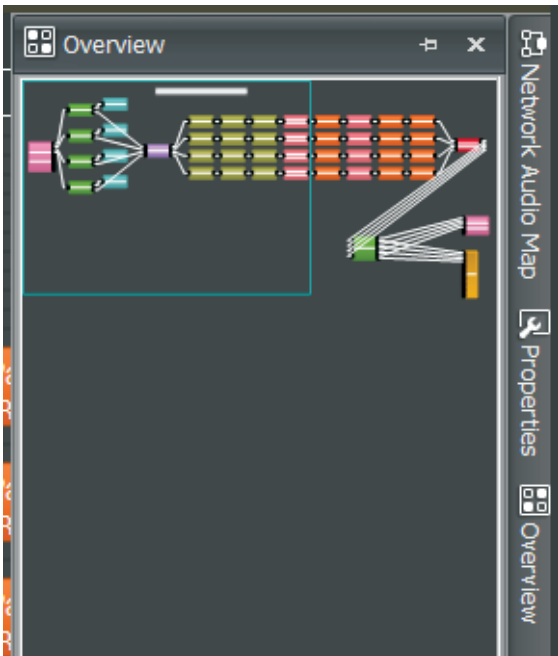

DM8000 Overview Screen

2.1.5 Properties Screen

The **Properties Screen** appears at the lower-left of the main screen and provides an editable table of attributes regarding the Build Window and its associated Component Objects. The Properties Screen is a handy way to edit multiple attributes of a selected Component Object without launching a Dialog Box.

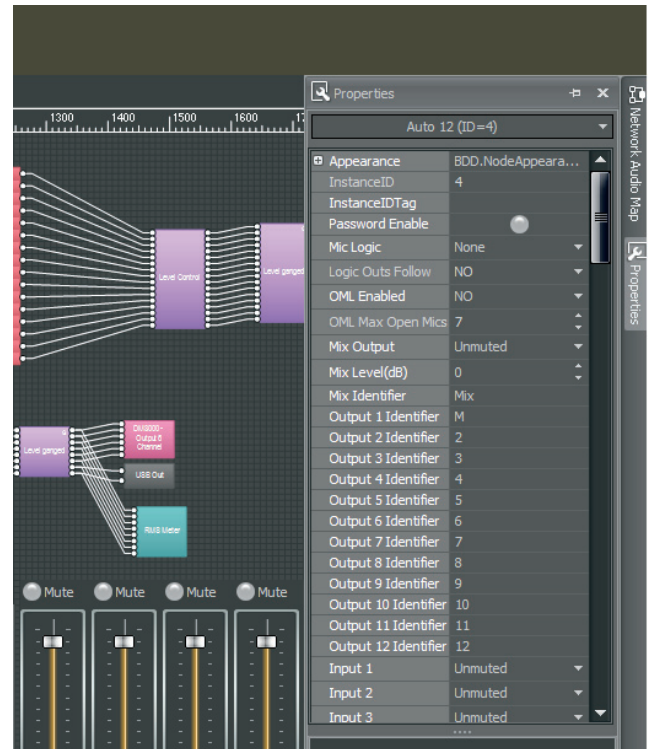

DM8000 Properties Screen

2.1.6 Module Library Panel

The **Module Library** of available Component Objects is displayed at the lower-left of the main screen for drag-and-drop placement into the Build Window. If needed, the Module Library can be closed to increase the width of the Build Window. When the Module Library is closed, Component Objects can then be selected and placed into the Build Window by using the Module Library Toolbar.

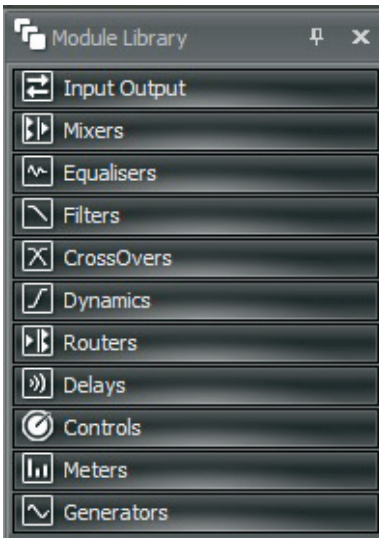

DM8000 Module Library Screen

2.1.7 Module Library Toolbar



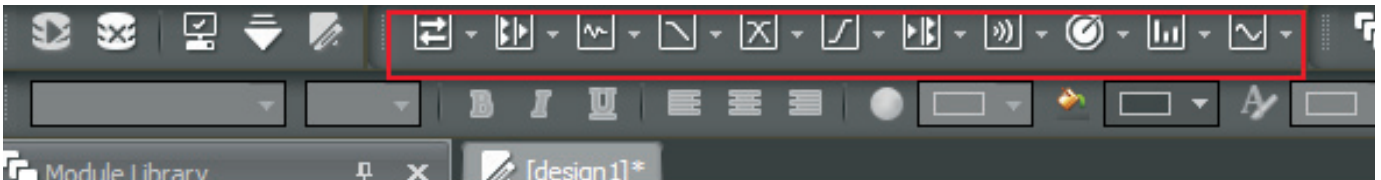







The **Module Library Toolbar** is located directly above the Build Window. Each icon in the toolbar represents a separate category of Processing Modules. Processing Modules can also be selected in the Module Library Toolbar for placement into the Build Window.



Module Library Toolbar

Module Library Toolbar Elements

The Module Library Toolbar contains icons representing the following categories of Processing Modules (for more detailed explanations of the Processing Modules functionality, see "Module Library" on pgs. 13-35):

	Input Output modules for routing audio signals into and out of the DM8000 DSP		Dynamics provide Leveler, CompLimiter, Ducker, Noise Gate, and ANC (Ambient Noise Compensator) functions
	Mixers provide typical audio mixing functions with several sub-categories		Routers offer audio routing and switching functions from simple source selection and signal-splitting to complicated input/output matrices
	Equalisers provide both graphic and parametric equalisation, as well as feedback suppression		Delays provide audio time delay functions for applications such as time alignment of loudspeakers over distance
	Filters provide High Pass, Low Pass, High Shelf, Low Shelf and All-Pass filters for applications that require rolling off of frequencies, simple tone controls, or phase compensation		Controls offer more detailed channel strip functions than the Router and Source Selection modules. These functions include more flexible level control, phase inversion, muting, logic-controlled switching and 'ganging' of multiple inputs to a single fader
	CrossOvers provide 2-way, 3-way and 4-way crossover functions		Meters provide Signal Present, Peak, RMS, and Logic Meter functions
			Generators provide sine-wave, sweep, pink-noise, and white-noise generator functions

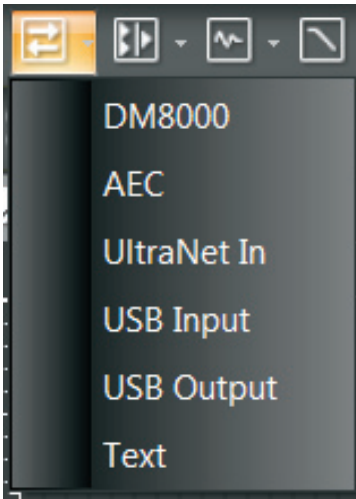

Input Output Toolbar Pulldown Menu

Each of the above Module Library Toolbar icons has a matching pulldown menu showing the various sub-categories of Processing Modules.

To place a Processing Module from the Module Library Toolbar into the Build Window, click on the desired category in the pulldown menu and then place the cursor into the Build Window and click. After clicking, the system will drop the relevant Component Objects into the Build Window's grid.

2.1.8 Format Toolbar

The **Format Toolbar** allows you to customize text and colors used in Component Objects in the Build Window. The Format Toolbar elements are only active when a specific Component Object is selected. Multiple Component Objects can be selected at once for text and color editing.

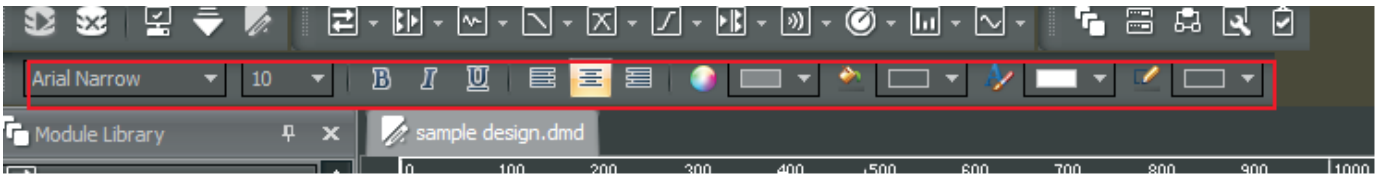

Format Toolbar

Format Toolbar Elements

	Font allows you to choose the font type from a pulldown menu
	Font Size determines the point size of the text in the selected Component Object
	Bold renders the selected text with a thicker look for emphasis
	Italic renders the selected text with a slanted look
	Underline places a line underneath the selected text
	Left Justify aligns the selected text along the left of the Component Object
	Center aligns the selected text along the middle axis of the Component Object
	Right Justify aligns the selected text along the right edge of the Component Object



Fore Color sets the foreground color of the Component Object



Background Color sets the background color of the Component Object

NOTE: When the selected Component Object has different ForeColor and Background colors, the system will create a gradient look with the selected foreground color at the top and the selected background color at the bottom.



Component Object with ForeColor/Background Gradient



Text Color sets the color of the text in the selected Component Object

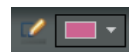

Border Color sets the color for the border line around the edges of the selected Component Object





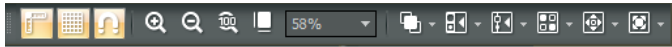







2.1.9 Build Toolbar

The **Build Toolbar** controls certain aspects of the Build Window, such as the grid, rulers, zooming and alignment of Component Objects.

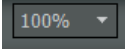

Build Toolbar

Build Toolbar Elements

	Ruler Bar places a ruler along the left and top sides of the Build Window for precise placement of Component Objects. Moving cursor lines inside the rulers show exact coordinates
	Grid On activates a grid in the background of the Build Window
	Snap to Grid causes Component Objects to “stick” to the grid as the Component Objects are moved around inside the Build Window
	Zoom In increases the magnification of the Build Window to make Component Objects bigger
	Zoom Out decreases the magnification of the Build Window so Component Objects appear smaller
	Zoom 1:1 returns Component Objects to their standard, default size in the Build Window
	Zoom to Fit automatically alters magnification in the Build Window so that an entire Signal Processing Architecture will be visible and fit inside the Build Window
	Zoom to Scale offers a pulldown menu so that you can immediately jump to a specific magnification setting (50%, 75%, 100%, 125%, 150%, and so on). You may also type the desired magnification setting directly into the Zoom to Scale window
	Order contains further sub-commands for changing the stacking order of Component Objects in the Build Window, including Bring to Front , Send to Back , Bring Forward and Send Backward
	Pack Objects removes spaces and arranges Component Objects as tightly as possible along the left, right, top or bottom edges of a group of objects
	Align Objects straightens a group of objects along the left, right, top, or bottom edges of the group of objects. You may also align a group of objects by using Horizontal Center or Vertical Middle commands
	Space Evenly equalizes the spacing in a group of objects by using Across, Down, Vertical or Horizontal commands
	Center in View moves the selected object or objects to the center of the Build Window
	Make Same Size will make a group of Component Objects all appear the same size. This function typically will make all objects in the group the same size as the smallest object in the selected group



2.1.10 DSP Operation Toolbar

The **DSP Operation Toolbar** contains functions for Compile, Download, Edit Mode, and so on.



DSP Operation Toolbar

DSP Operation Toolbar Elements

	Compile prepares your design to run on the DSP, checks the design for problems, notifies you of errors that need to be corrected, and calculates the percentage of DSP resources in use
	Download Design to Device sends the compiled design to the DSP processor
	Enter Editing Mode



2.1.11 Network Toolbar

The **Network Toolbar** contains functions related to starting and stopping network connections.



Network Toolbar

Network Toolbar Elements

	Start Network Service activates network connections to compile and install DSP designs, update firmware and run audio through the network
	Stop Network Service shuts down your network





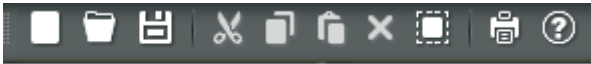





2.1.12 Standard Toolbar

The **Standard Toolbar** contains file functions such as New, Open and Save, plus additional editing functions such as Cut, Copy, Paste, Print and Help.



Standard Toolbar

Standard Toolbar Elements

	New begins a new .dmd file
	Open opens an existing .dmd file
	Save saves the current .dmd file
	Cut removes selected text and objects from the Build Window and places the cut material into the clipboard
	Copy makes a copy of selected text and objects, and places the copied material into the clipboard
	Paste places material from the clipboard into the selected location
	Delete removes selected text or objects from the Build Window
	Select All automatically selects every object in the Build Window
	Print sends out a hardcopy rendering of the currently active design in the Build Window to a printer
	Content launches Help files





2.1.13 View Toolbar

The **View Toolbar** allows you to quickly launch various panels including the Module Library Panel, Device Panel, Network Panel, Properties Panel and the Compile Output Panel.



View Toolbar

View Toolbar Elements

	Module Library launches the Module Library screen
	Device Panel launches the Device Panel
	Network Panel launches the Network Panel
	Properties Panel launches the Properties screen
	Compile Output launches the Compile Output screen

2.1.14 Main Menus

Main Menus provide all of the toolbar functions mentioned above via pulldown menus, with several more in-depth editing functions.

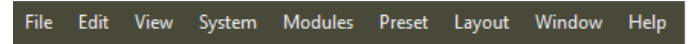

Main Menu

Main Menu Elements

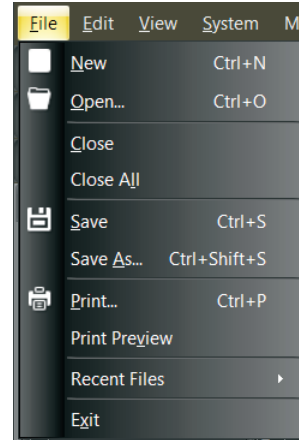

File Pulldown Menu

File Pulldown Menu contains the following commands:

- **New** creates a new .dmd file.
- **Open** opens an existing .dmd file.
- **Close** closes the current .dmd file open in the Build Window.
- **Close All** closes all currently open .dmd tabs in the Build Window.
- **Save** saves the current .dmd file.
- **Save As** allows you to save the current .dmd file and designate a file name.
- **Print** prints out a hardcopy of the current design in the Build Window.
- **Print Preview** lets you view the current design as it will appear in the printout before you print.
- **Recent Files** opens an additional pulldown menu with a list of recent .dmd files available for quick selection.
- **Exit** shuts down the DSP Designer software.

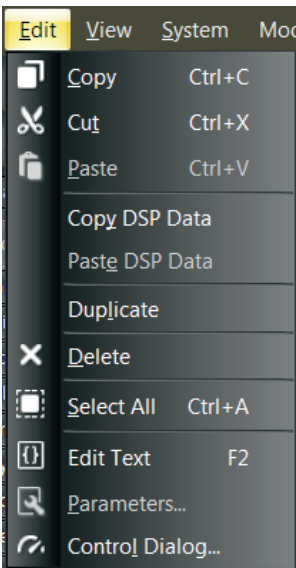

Edit Pulldown Menu

Edit Pulldown Menu contains the following commands:

- **Copy** makes a copy of selected text and objects, and places the copied material into the clipboard.
- **Cut** removes selected text and objects from the Build Window and places the cut material into the clipboard.
- **Paste** places material from the clipboard into the selected location.
- **Copy DSP Data**
- **Paste DSP Data**
- **Duplicate**
- **Delete** removes selected text or objects from the Build Window.
- **Select All** automatically selects every object in the Build Window.
- **Edit Text** lets you access and edit text in the currently-selected Component Object in the Build Window.
- **Parameters** launches the Parameters Dialog Box for the currently-selected Component Object in the Build Window.
- **Control Dialog** launches the Control Dialog Box for the currently-selected Component Object in the Build Window.

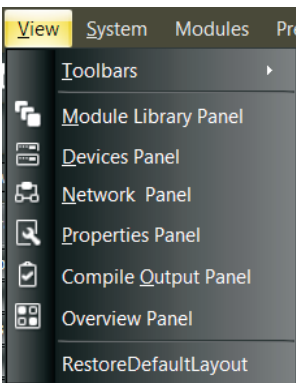

View Pulldown Menu

View Pulldown Menu contains the following commands:

- **Toolbars** launches an additional menu showing which toolbars are currently selected and visible. Currently-selected toolbars appear with a check mark.
- **Module Library Panel** launches the Module Library panel on the left side of the Main Screen.
- **Device Panel** launches a panel with a list of devices currently connected to the DSP Designer software.
- **Network Panel** launches the Network Audio Map on the right side of the Main Screen.
- **Properties Panel** launches a Properties window for the currently-selected Component Object in the Build Window.
- **Compile Output Panel** opens a window that shows results and feedback from the Compile command.
- **Overview Panel** launches a window on the right side of the Main Screen that shows the entire design currently in the Build Window. The Overview Panel is useful when a design exceeds the available space in the current Build Window.
- **RestoreDefaultLayout** re-configures the Main Window with the default toolbars and other screens.

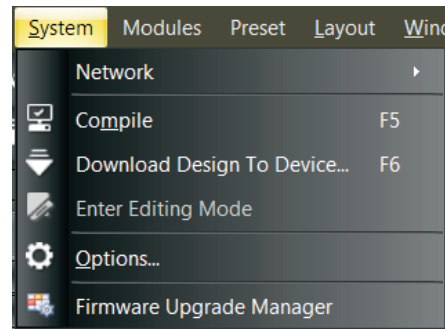

System Pulldown Menu

System Pulldown Menu contains the following commands:

- **Network** launches an additional menu with the Start Network Service and Stop Network Service commands (also contained in the Network Toolbar).
- **Compile** prepares your design to run on the DSP, checks the design for problems, notifies you of errors that need to be corrected, and calculates the percentage of DSP resources in use.
- **Download Design To Device** sends the compiled design to the DSP processor.
- **Enter Editing Mode**
- **Options** launches an additional window with a tab for General settings (Enable toolbar customization and Log debug info) and a Network tab for selecting the Default Network Interface Card.
- **Firmware Upgrade Manager** launches a window to enable firmware updates for multiple devices in your network.

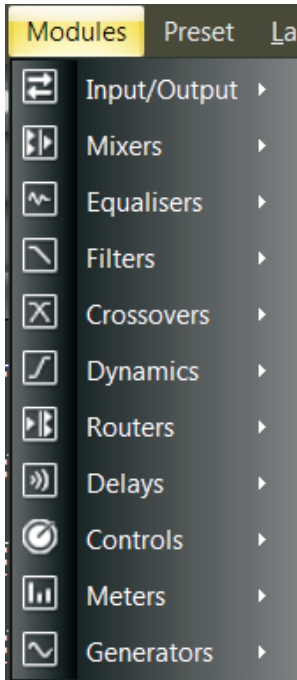

Modules Pulldown Menu

Modules Pulldown Menu contains multiple sub-menus for choosing and placing Processing Modules into the Build Window. This menu is a third option for placing Modules, in addition to the **Module Library Toolbar** (see pgs. 16-17) and the **Module Library Panel** (see pg. 6).

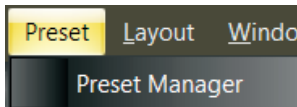

Preset Pulldown Menu

Preset Pulldown Menu contains a single command for launching the **Preset Manager** window.

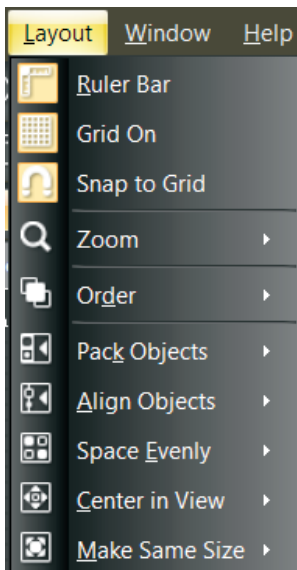

Layout Pulldown Menu

Layout Pulldown Menu contains and repeats the following commands from the Build Toolbar:

- **Ruler Bar** places a ruler along the left and top sides of the Build Window for precise placement of Component Objects. Moving cursor lines inside the rulers show exact coordinates.
- **Grid On** activates a grid in the background of the Build Window.
- **Snap to Grid** causes Component Objects to “stick” to the grid as the Component Objects are moved around inside the Build Window.
- **Zoom** has an additional sub-menu with all of the Zoom commands from the Build Toolbar:
 - **Zoom In** increases the magnification of the Build Window to make Component Objects bigger.
 - **Zoom Out** decreases the magnification of the Build Window so Component Objects appear smaller.
 - **Zoom 1:1** returns Component Objects to their standard, default size in the Build Window.
 - **Zoom to Fit** automatically alters magnification in the Build Window so that an entire Signal Processing Architecture will be visible and fit inside the Build Window.
- **Order** contains further sub-commands for changing the stacking order of Component Objects in the Build Window, including **Bring to Front**, **Send to Back**, **Bring Forward** and **Send Backward**.
- **Pack Objects** removes spaces and arranges Component Objects as tightly as possible along the left, right, top or bottom edges.
- **Align Objects** straightens a group of objects along the left, right, top, or bottom edges of the group of objects. You may also align a group of objects by using Horizontal Center or Vertical Middle commands.
- **Space Evenly** equalizes the spacing in a group of objects by using Across, Down, Vertical or Horizontal commands.
- **Center in View** moves the selected object or objects to the center of the Build Window.
- **Make Same Size** will make a group of Component Objects all appear the same size. This function typically will make all objects in the group the same size as the smallest object in the selected group.

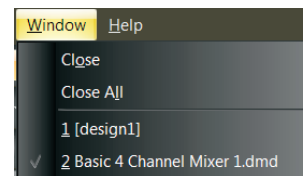

Window Pulldown Menu

Window Pulldown Menu repeats the File commands for Close and Close All, along with a list of currently open tabs in the Build Window for quick selection.

Help Pulldown Menu contains two commands:

- **Content** launches a window with Help files.
- **About** launches a separate window showing the current version of the DSP Designer software.

2.1.15 Status Bar

The **Status Bar** displays connected devices and the amount of available DSP power in use.



Status Bar

2.1.16 Device Panel

The Device Panel gives a complete list of devices available via Ethernet networking.

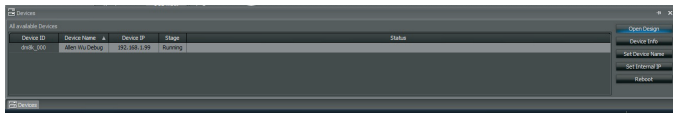

DM8000 Devices Panel

The Device Panel can be launched from either the View Toolbar (click on the Device Panel Icon) or from the View Pulldown Menu.

- **Device Info** button will launch the Device Information Display for quick reference of each device's network configuration.



Device Information Display

- **Set Device Name** button launches the Set Device Name & Description dialog box so you may assign customized name to each device and write up a brief description of the device's role and function in your network.

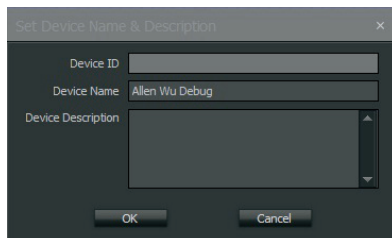

Set Device Name & Description Dialog Box

- **Set Internal IP** button launches a dialog box where you may assign IP addresses for each device in your network.

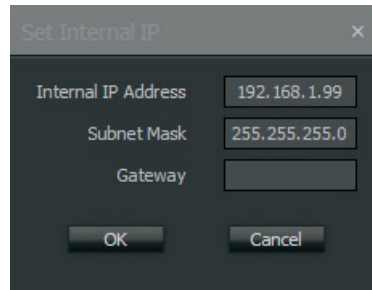

Set Internal IP Dialog Box

- **Reboot** button launches the Firmware Upgrade Manager Control Dialog so you may update firmware for selected devices.

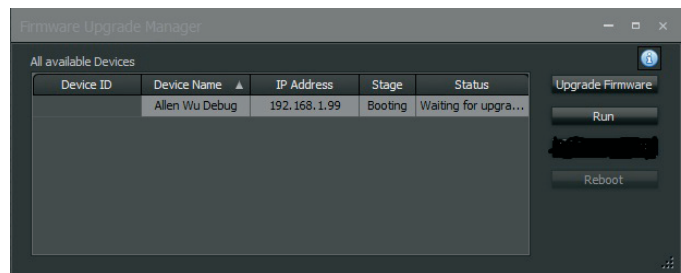

Firmware Upgrade Manager Dialog Box

2.1.17 Network Panel

The **Network Panel** shows a map of the entire network system and the flow of audio through the system.

2.1.18 Compile Output Panel

The **Compile Output Panel** displays the results of the Compile command.

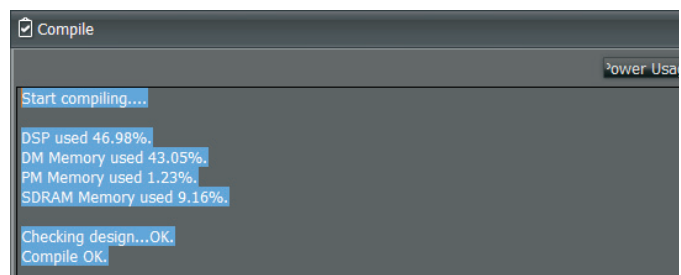

Compile Output Panel

When the Compile process encounters problems with the signal processing design, the system will open a Compile Output Panel listing the various errors in the design:

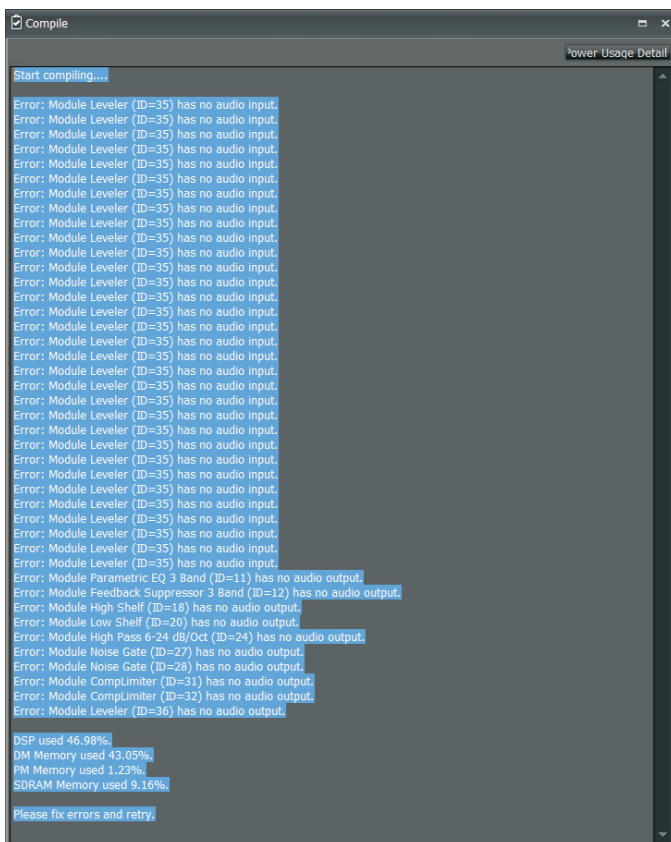

Compile Output Panel with Errors Displayed

3. Module Library

The DM8000 DSP is equipped with comprehensive library of processing modules that can be deployed and configured by using the DM8000 DSP Designer software. You can build the entire processing structure and signal routing using the DM8000 DSP Designer software, and then compile the configuration and run it in the DM8000 DSP.

To deploy a specific module, click on that module's graphic icon in the Module Library screen, and then drag the module into the Build Window. Alternately, you can also use the Module Library Toolbar to access all of the DM8000 modules.

Once a module is placed into the Build Window, the module "unzips" and the Component Objects contained in the Module appear on screen. All available settings can then be accessed by right-clicking over the desired Component Object. Right-clicking launches a Control Dialog Box, which displays the component controls in a more conventional user interface where you can program settings and make other adjustments.

3.1 Input Output Modules

To open the Input Output Module Library, click on the Input Output tab in the lower left of the screen, or use the Module Library Toolbar at the top of the screen.

3.1.1 DM8000

The **DM8000** module is the first module contained in the Input Output Module Library.



DM8000 Module Icon

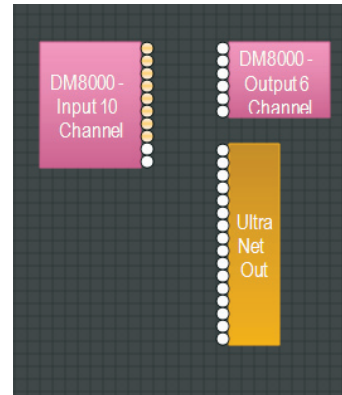

DM8000 Module Component Objects

Once deployed in the Build Window, the DM8000 module unfolds into three Component Objects:

- DM8000 Input 10 Channel
- DM8000 Output 6 Channel
- UltraNet Out

These Component Objects can be moved and placed separately where needed.

DM8000 Input 10 Channel

The **DM8000 Input 10 Channel** component object routes analog audio signals from the 10 analog inputs on the DM8000 rear panel into the DSP for processing. Analog audio inputs that are equipped with Acoustic Echo Cancellation (AEC) appear with a light orange color.

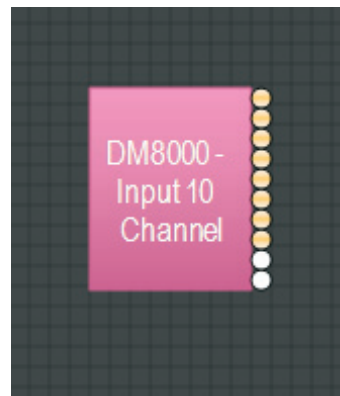

DM8000 Input 10 Channel Component Object

Right-click to access the Component Object's Dialog Box, with the following controls:

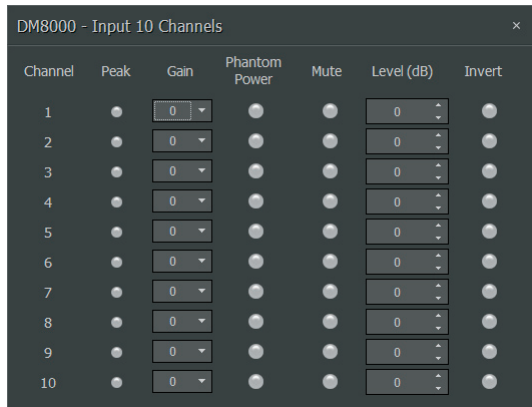

DM8000 Input 10 Channel Dialog Box

- **Peak** flashes only occasionally when a signal exceeds the channel headroom (6dB headroom).
- **Gain** compensates for different input levels (mic or line).
- **Phantom Power** assigns +48 Volt phantom power to the input for condenser microphones.
- **Mute** switches the input signal on or off.
- **Level (dB)** adjusts the relative input volume.
- **Invert** reverses the polarity of the input signal.

DM8000 Output 6 Channel

The **DM8000 Output 6 Channel** component object routes analog audio signals out from the DSP to the six analog outputs on the DM8000 rear panel.

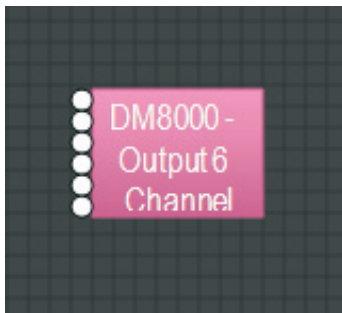

DM8000 Output 6 Channel Component Object

Right-click to access the Component Object's Dialog Box, with the following controls:

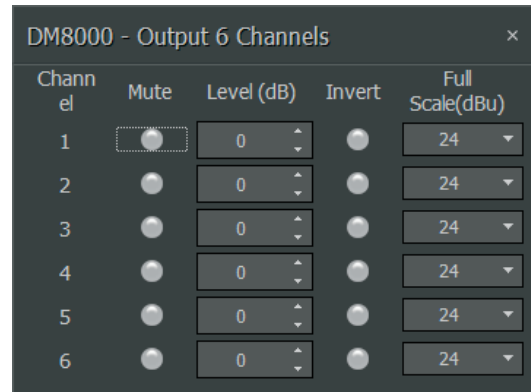

DM8000 Output 6 Channel Dialog Box

- **Mute** turns the output signal on or off.
- **Level** adjusts the relative output volume.
- **Invert** reverses the polarity of the output signal.
- **Full Scale** selects the appropriate maximum output reference level (mic or line).

UltraNet Out

The UltraNet Out Component Object connects the DSP processor to the ULTRANET OUT connection on the rear panel of the DM8000 hardware unit.

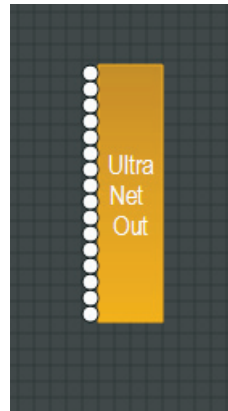

UltraNet Out Component Object

3.1.2 AEC 1 and AEC N Modules

AEC 1 and AEC N modules provide Acoustic Echo Cancellation (AEC). When designing an AEC processing channel for DM8000, drag in AEC 1 for a single channel of processing, or drag in AEC N for multiple channels (within the AEC N module, the user can select up to 8 AEC channels, numbered 1 through 8).

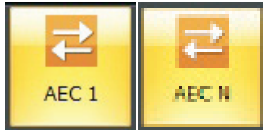

AEC 1 and AEC N Module Icons

AEC 1 and AEC N Component Objects

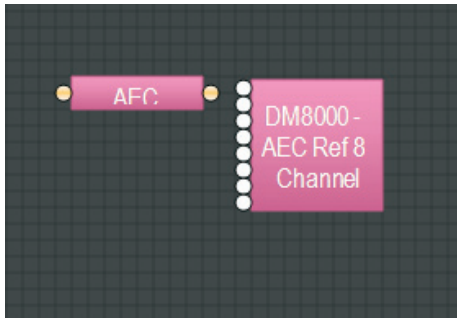

AEC 1 and AEC N Component Objects

The **AEC Ref 8 Channel** sub-module automatically appears when either AEC 1 or AEC N modules are dragged into the Build Window. This module processes a signal as a reference baseline for the AEC process.

AEC 1 and AEC N Component Object Dialog Boxes

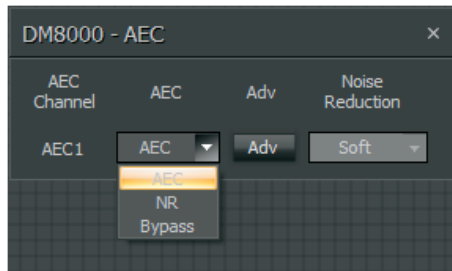

AEC Dialog Box

The **AEC 1** and **AEC N** control dialogue allows the user to select between **AEC**, **NR** and **Bypass** settings.

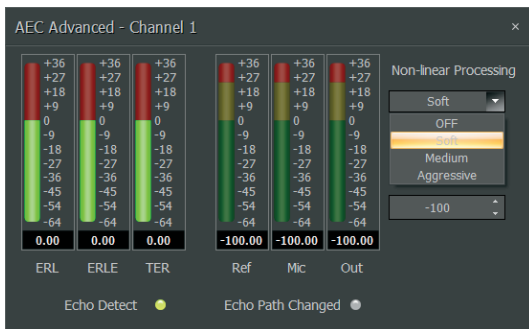

AEC Advanced Dialog Box

Selecting the **Adv** tab launches an **AEC Advanced** dialogue window, where you can select between **Non-Linear Processing** options (**OFF**, **Soft**, **Medium**, **Aggressive**).

The following graphic describes a typical AEC system:

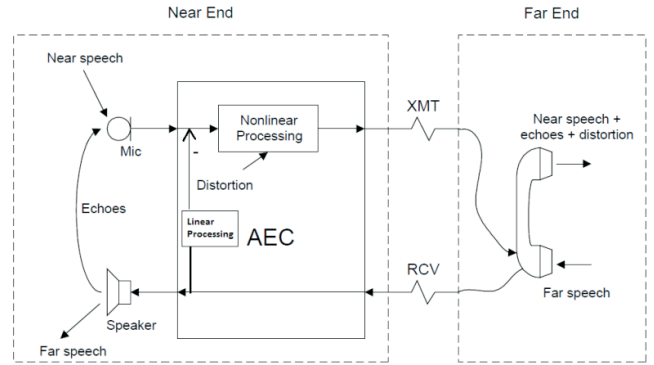

Typical AEC system

For DM8000, a typical AEC design will resemble the following graphic:

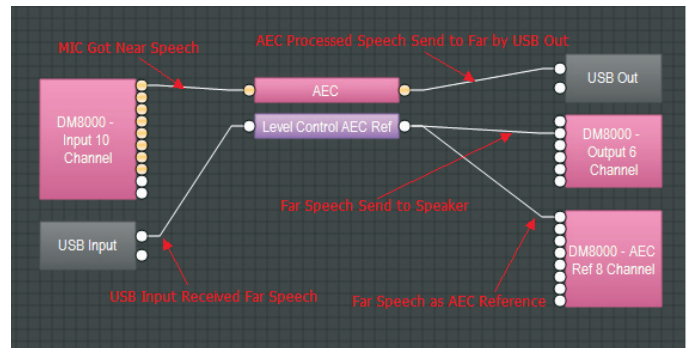

Typical AEC design in DSP Designer

3.1.3 UltraNet In

UltraNet In module supports MUSIC GROUP's own proprietary ULTRANET digital audio format. ULTRANET audio enters DM8000 through the included ULTRANET IN port on the rear of the DM8000 hardware unit.

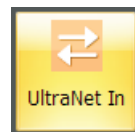

UltraNet In module icon

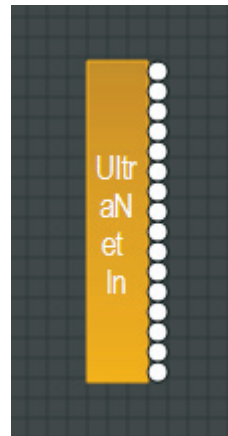

UltraNet In Component Object

3.1.4 USB Input and USB Out

USB Input and USB Out modules support 2-channel input and output for USB audio at 24-bit sample size.

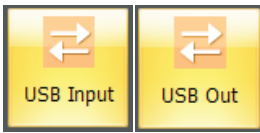

USB Input and USB Out Module Icons

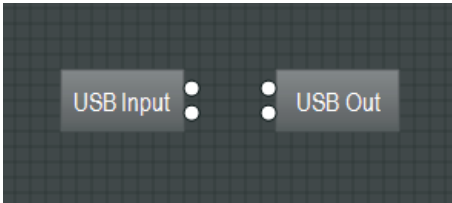

USB Input and USB Out Component Objects

3.1.5 Text

Text module allows you to place customized text descriptions wherever needed in the Build Window. To edit text in the module, press **F2** or **right-click** and select **Edit Text**.

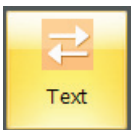

Text Module Icon

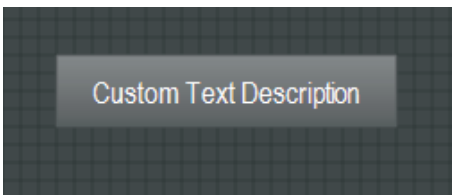

Text Module Component Object

3.1.6 Dante In/Out

The **Dante In** and **Dante Out** modules support Dante digital networking based on Audinate's Brooklyn II module. The Dante modules are fixed at 16 input and 16 output channels. These modules can be re-named in the DM8000 DSP Designer software.

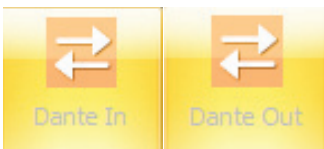

Dante In/Out Module Icons

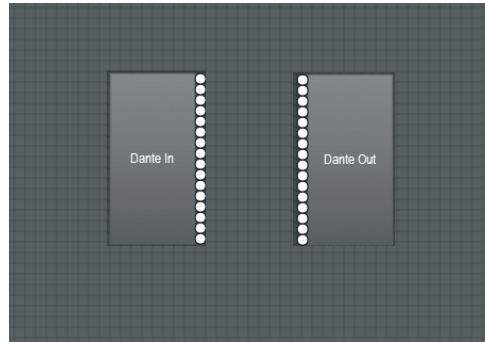

Dante In and Dante Out Component Objects

NOTE: When connecting DM8000 devices and Dante cards at the same time, make sure the IP address of the PC, DM8000 and Dante cards share the same subnet.

About Dante Digital Networking

Dante is a proprietary digital media networking solution developed by Audinate and licensed by MUSIC GROUP, which operates on 100 Mbps and Gigabit networks using standard Internet Protocol (IP) over Ethernet. A Dante stream distributes both audio and integrated control data over the network. Dante allows for transport of low-latency, uncompressed audio over standard IP Ethernet networks with sample-accurate synchronization, automatic device and channel discovery, and easy –to-use signal routing.

Many of the properties of the Dante streams (or channels) are configurable only through Audinate's Dante Controller software. Most importantly, routing of audio signals from transmit to receive between devices is accomplished in Dante Controller. Once online, routing and channel assignment can only be done in Dante Controller software.

3.2 Mixers

Mixer modules provide typical audio mixing functions in four categories:

- Standard Mixers
- Matrix Mixers w/Delay
- Matrix Mixers
- Auto Mixers

Mixers are available in pre-defined configurations, however, the configuration may be customized. Once a Component Object is placed into the Build Window, all available settings can be accessed by double-clicking over the object. This produces a Control Dialog Box, which displays the component controls in a more conventional user interface.

To open the **Mixers Module Library**, click on the **Mixers** tab in the lower left of the screen, or use the **Module Library Toolbar** at the top of the screen.

3.2.1 Auto Mixer

Auto Mixer modules automatically adjust and balance levels for multiple inputs before sending the combined signal to a single output.

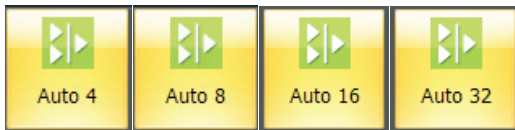

Auto Mixer Module Icons

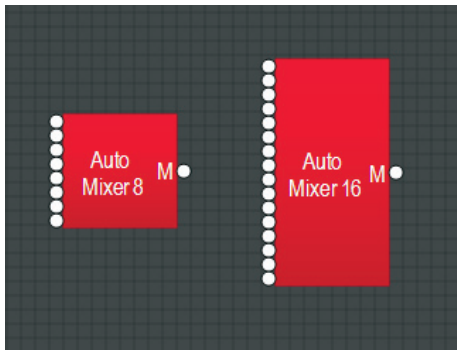

Auto Mixer Component Objects

Auto Mixer Dialog Boxes

Double-click to open the **Control Dialog Box** and access the following settings:

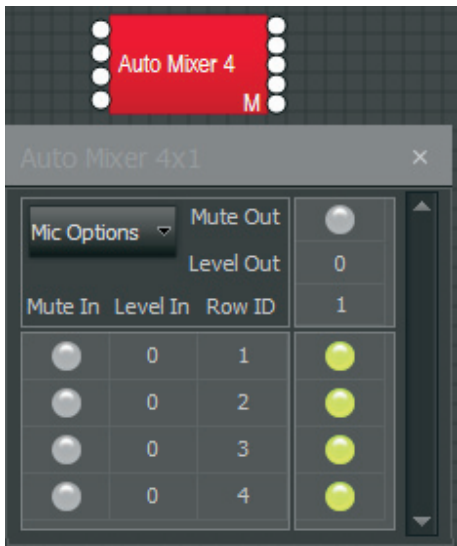

Auto Mixer Dialog Box

- **Mute In** turns the input signal on or off.
- **Level In** adjusts the relative input volume.
- **Mute Out** turns the output signal on or off.
- **Level Out** adjusts the relative output volume.

Mic Options

Mic Options opens a separate control dialog box to establish global settings:

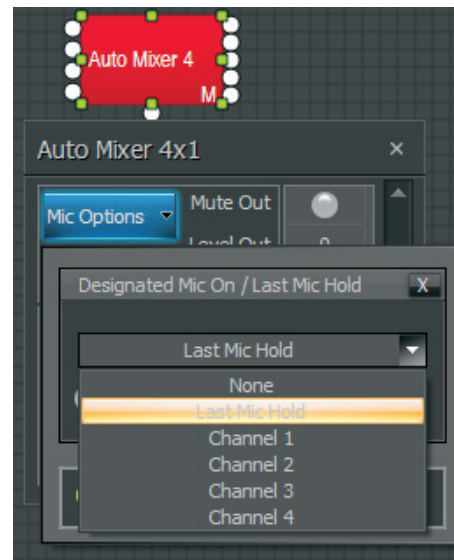

Auto Mixer Mic Options Dialog Box

- **Designated Mic On / Last Mic Hold** determines which microphone (if any) will stay/become active when no signal is present.
- **Logic Outputs Follow Mic Logic** assigns logic outputs to follow Designated Mic On / Last Mic Hold.
- **Open Mic Limits** enables (and designates) a maximum allowable number of active microphones.

Channel Settings

Channel Settings can be accessed by right-clicking over the Row ID assignment nodes. Channel Settings affects individual channel settings, but may also be applied globally to all channels within the Auto Mixer module.

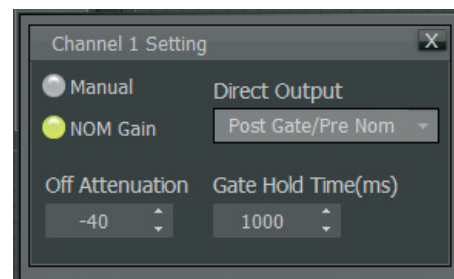

Channel Settings Dialog Box

- **Manual** turns channel gating on or off.
- **NOM Gain** activates/deactivates the channel contribution to NOM (number of open mics) attenuation.
- **Direct Output** designates channel direct output signal as Post Gate / Pre NOM or Post Gate / Post NOM. (Direct Outputs must be enabled when placing Auto Mixers from the Module Library Toolbar.)
- **Set All** causes current Channel Settings to be applied to all channels.
- **Off Attenuation** determines the amount of attenuation applied when the channel is inactive.
- **Gate Hold Time** determines length of time before the channel becomes inactive once signal is no longer present.

Logic Outputs

Logic Outputs affects individual Logic Output settings, but may be applied to all Logic Outputs. (Logic Outputs must be activated when placing Auto Mixers from the Module Library Toolbar).

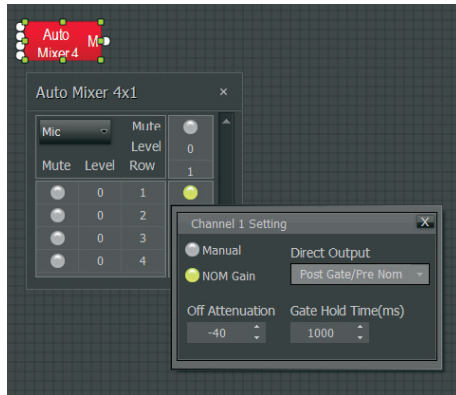

Logic Outputs Dialog Box

- **Logic Output** selects Follow Gate, On or Off condition of the Logic Output.
- **Invert** reverses operation of the Logic Output (off when channel active).
- **Set All** causes current Logic Output settings to be applied to all channels.

3.2.2 Standard Mixer

Standard Mixer modules offer controls most similar to regular analog mixers.

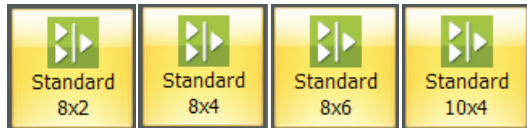

Standard Mixer Module Icons

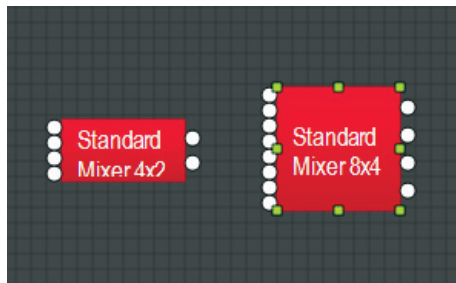

Standard Mixer Component Objects

Right-click to access the Component Object's Dialog Box, with the following controls:

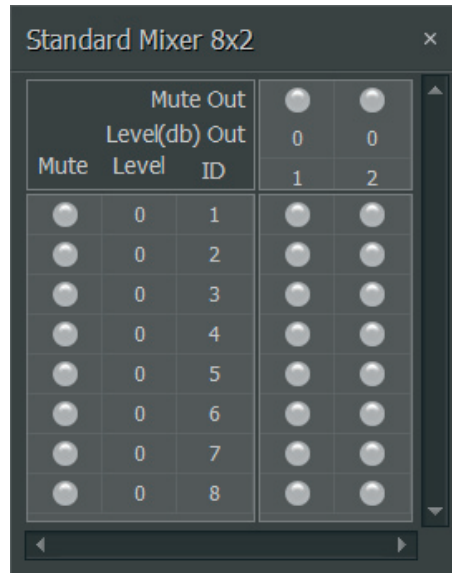

Standard Mixer Dialog Box

- **Mute In** turns the input signal on or off.
- **Level In** adjusts the relative input volume.
- **ID** assigns inputs to specific outputs.
- **Mute Out** turns the output signal on or off.
- **Level Out** adjusts the relative output volume. Right-clicking over certain settings will provide a menu of additional options

3.2.3 Matrix Mixer

Matrix Mixer modules offer extended bus routing options.

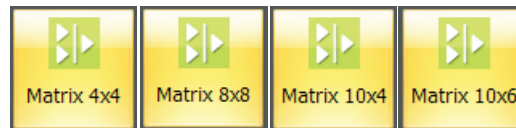

Matrix Mixer Module Icons

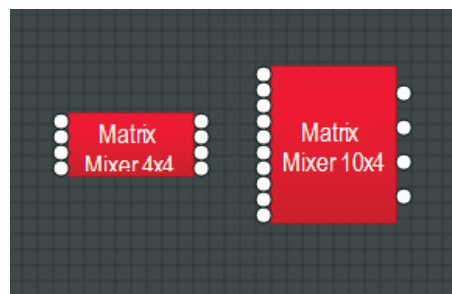

Matrix Mixer Component Objects

Right-click to access the Component Object's Dialog Box, with the following controls:

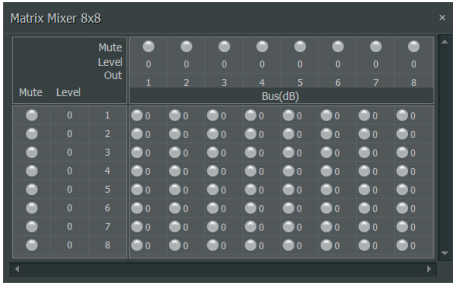

Matrix Mixer Dialog Box

- **Mute In** turns the input signal on or off.
- **Level In** adjusts the relative input volume. Left-click to adjust levels.
- **Assign Matrix** assigns inputs to specific outputs.
- **Mute Out** turns the output signal on or off.
- **Level Out** adjusts the relative output volume.

3.2.4 Matrix w/Delay

Matrix w/Delay adds a delay feature but otherwise functions like the Matrix Mixer.

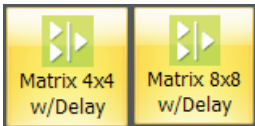

Matrix w/Delay Module Icons

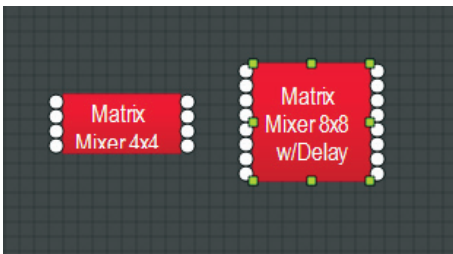

Matrix w/Delay Component Objects

Right-click to access the Component Object's Dialog Box, with the following controls:

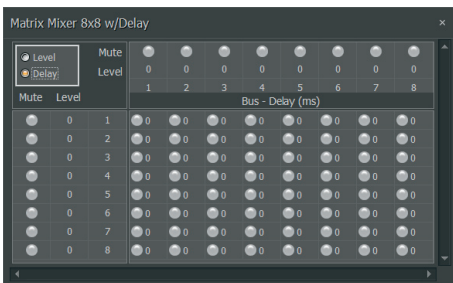

Matrix w/Delay Dialog Box

- **Mute In** turns the input signal on or off.
- **Level In** adjusts the relative input volume. Left-click to adjust levels.
- **Assign Matrix** assigns inputs to specific outputs.

- **Mute Out** turns the output signal on or off.
- **Level Out** adjusts the relative output volume. Left-click to adjust levels.
- **Delay** adjustment is same as level adjustment.

3.2.5 Room Combiner

The Room Combiner module acts as a router that can manage audio streams routing and control of combinable/divisible spaces. This module can support a maximum of 16 rooms in numerous configurations, with combinable levels, muting and source tracking. Logic inputs and outputs are provided for wall state and source selection, as well as the ability to combine and control the function of Auto Mixer modules connected to the Room Combiner module's inputs.

When a Room Combiner module is dropped into the Build Window, the software will automatically launch a Parameter Dialog Box:

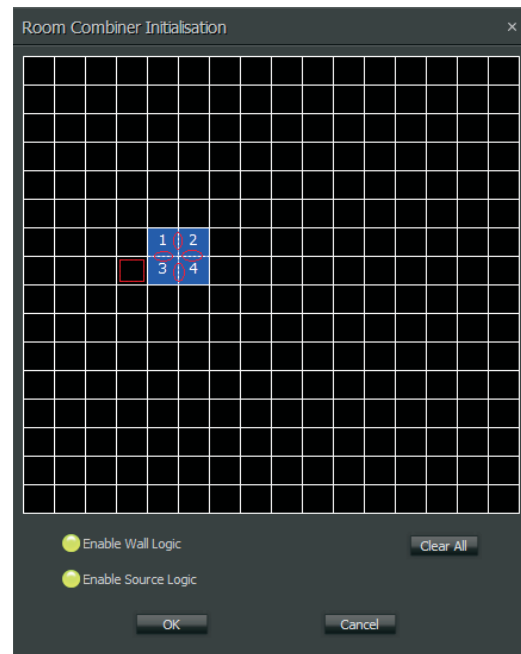

Room Combiner Initialisation Dialog Box

In the Dialog Box, Room Combiner uses a 16x16 grid of blocks to lay out graphically the relative position of each room. Adjacent, enabled blocks in the grid can have three types of walls: permanent, removable and none. The wall type is selected by repeatedly clicking on the border between adjacent enabled blocks.

- **Clear All** button removes all blocks from the grid.
- **Enable Wall Logic** controls whether the Room Combiner Component Object will have logic connections for wall state.
- **Enable Source Logic** determines whether logic connections for source selection will appear on the Component Object.

Please keep in mind the following points:

- Removable walls are indicated by a thin dashed line, and the removable wall will have a corresponding logic node on the block.
- Permanent walls are indicated by a thick gray line that represents a non-removable border between those rooms. A permanent wall will not have a logic connection on the block.
- No border between adjacent enabled blocks indicates there is no wall, and the adjacent enabled blocks are therefore considered part of the same space.

- Rooms that are combinable via a removable wall will share at least one border.

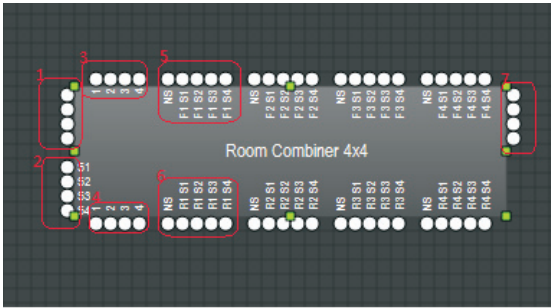

Room Combiner Component Object

The Room Combiner Component Object can display the following types of input and output terminals (refer to the numbered items in the screenshot above):

1. **Standard** input terminals. Each room has one input
2. **Auxiliary** audio input terminals. Each room has one auxiliary input, and each room can select any one of these auxiliary audio inputs.
3. **Logic Input** terminals. Each wall has one logic input terminal. When the logic input receives a signal from HIGH-to-LOW, the relative wall is removed. When the logic input received signal from LOW-to-HIGH, the relative wall is placed.
4. **Logic Output** terminal. Each wall has one logic output. When a wall is placed (by logic input or by manual set), the related logic output will be HIGH. When a wall is removed, the related logic output will be LOW.
5. **Logic Input** for Auxiliary Audio Input selection, which can be used to determine auxiliary audio input.
6. **Logic Output** of Auxiliary Audio Input, which is determined by auxiliary audio input selection.
7. **Standard** output terminals. Each room has one output.

Double-clicking the Room Combiner Component Object produces the following Control Dialog Box:

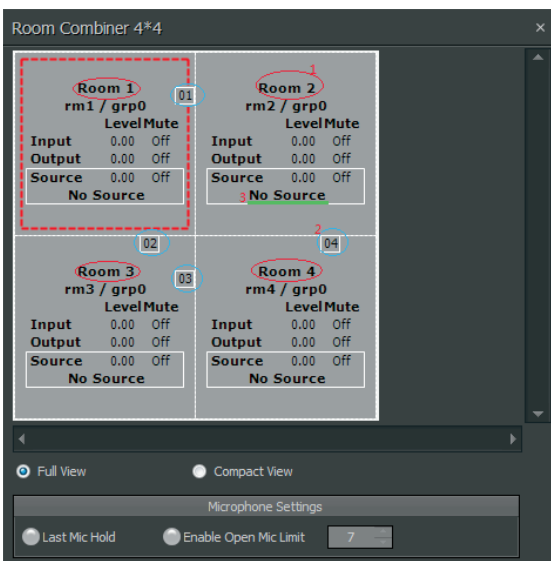

Room Combiner Control Dialog Box

This Dialog Box offers the following labels and functions (refer to the above screenshot):

- **Room Name** can be edited as #1 in the above screenshot.
- **Wall ID** is visible as in #2 in the above screenshot.
- **Auxiliary Audio** selection is displayed as in #3 above.
- **Last Mic Hold** and **Open Mic Limits** are connected with Auto Mixer.

The Room Combiner Dialog Box also shows information about combined rooms and walls:

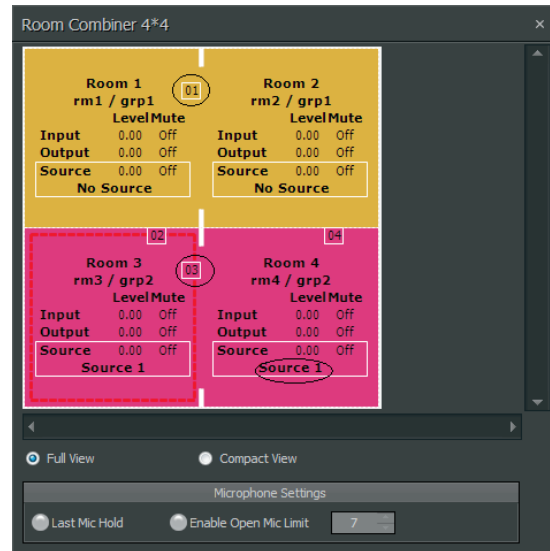

- Room 1 and Room 2 have been combined into Group 1 (shown as “grp1”, please see the gold group). Wall 01 has been opened to combine the rooms.
- Room 3 and Room 4 have been combined into Group 2 (shown as “grp2”, please see the hot pink group). Wall 03 has been opened to combine the rooms.

3.3 Equalisers

Equaliser modules provide both graphic and parametric equalisation, as well as feedback suppression. Equalisers may be connected between any components within the Build Window, for applications which require room equalization, tone adjustment, or feedback control. Equalisers appear in pre-defined configurations, but these configurations may be customized when placing modules from the Module Library Toolbar.

3.3.1 Parametric Equaliser

Parametric Equaliser offers standard parametric functionality.

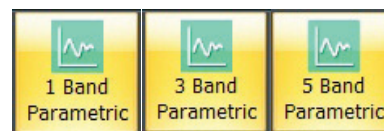

Parametric Equaliser Module Icons

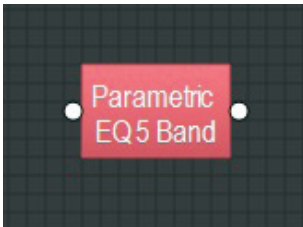

Parametric Equaliser Component Object

Right-click to access the Component Object's Dialog Box, with the following controls:

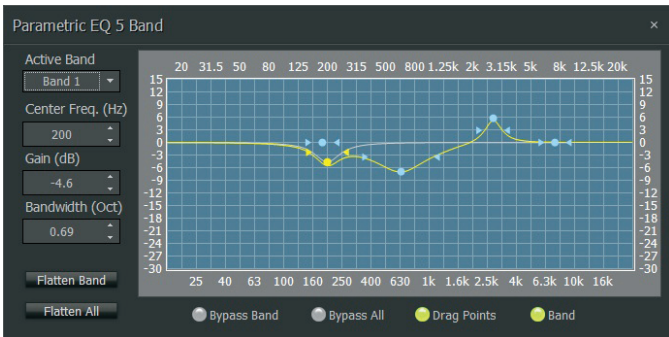

Parametric Equaliser Dialog Box

- **Active Band** selects the frequency band to be adjusted.
- **Center Freq.** adjusts the center frequency for the current band.
- **Gain** adjusts the amount of cut or boost applied at the center frequency for the current band.
- **Bandwidth** adjusts the range of frequencies, above and below the center frequency, which are also affected by the current band. These settings may also be adjusted by dragging the band controls shown inside the graph. Dragging the white dot affects both Center Freq and Gain. Dragging either yellow dot affects Bandwidth.
- **Flatten Band** and **Flatten All** changes the band Gain to "0" (flat).
- **Bypass Band** and **Bypass All** disables bands without changing settings.
- **Drag Points** turns the band controls on or off, revealing the resultant curve only.
- **Band** highlights the current band inside the graph.

3.3.2 Graphic Equaliser

Graphic Equaliser adjusts frequencies in set frequency bands.

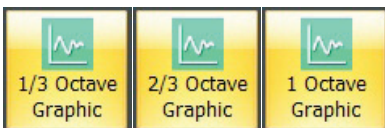

Graphic Equaliser Module Icons

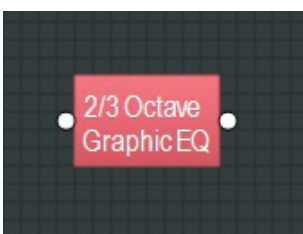

Graphic Equaliser Component Object

Right-click to access the Component Object's Dialog Box, with the following controls:

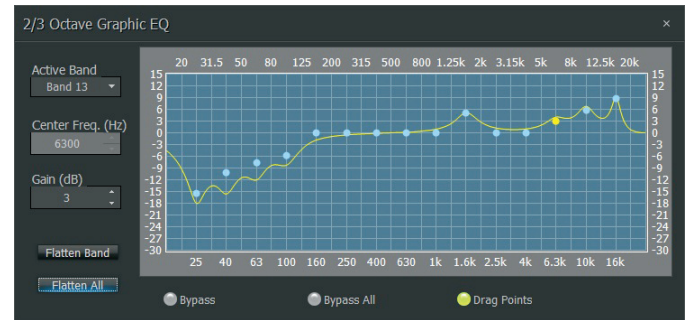

Graphic Equaliser Dialog Box

- **Active Band** selects the current frequency band to be adjusted.
- **Center Freq.** displays the center frequency for the current band.
- **Gain** adjusts the amount of cut or boost applied at the center frequency for the current band.
- **Active Band** and **Gain** may also be adjusted by dragging the band controls shown inside the graph. The selected band control becomes yellow, and dragging it up or down affects Gain for that band.
- **Flatten Band** and **Flatten All** changes the band Gain to "0" (flat).
- **Bypass Band** and **Bypass All** disable the band(s) without changing settings.
- **Drag Points** turns the band controls on or off, revealing the resultant curve only.

3.3.3 Feedback Suppressor

Feedback Suppressor behaves like automatic cut-only Parametric Equaliser module. Parametric equalisers utilize automatically-assignable bands of equalization which detect and remove feedback frequencies.

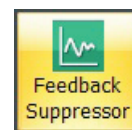

Feedback Suppressor Module Icon

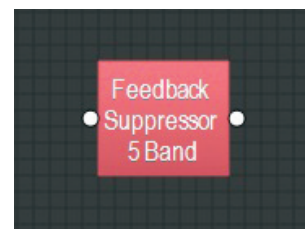

Feedback Suppressor Component Object

Right-click to access the Component Object's Dialog Box, with the following controls:

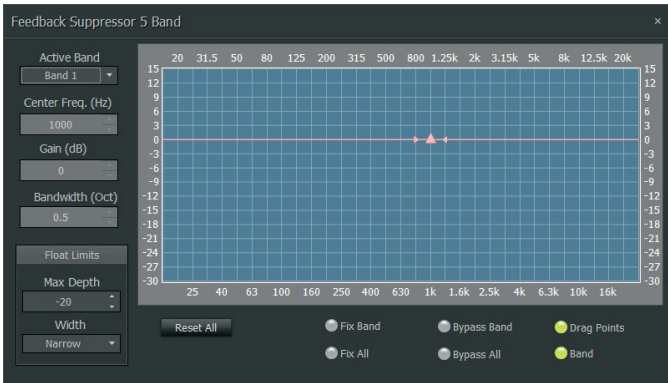

Feedback Suppressor Dialog Box

- **Active Band** selects the current band for which settings will be displayed.
- **Center Freq.** displays the center frequency for the current band.
- **Gain** displays the amount of cut applied at the center frequency for the current band.
- **Bandwidth** displays the range of frequencies, above and below the center frequency, which are also affected by the current band. Float Limits restricts all floating bands to a selected maximum depth (cut) and bandwidth (Narrow = 1/40-octave; Wide = 1/10-octave).
- **Reset All** temporarily returns the gain of all floating bands to 0dB (flat).
- **Fix Band** and **Fix All** frees frequency bands to become manually adjustable (non-floating).
- **Bypass Band** and **Bypass All** disable frequency band without changing settings.
- **Drag Points** turns the band controls on or off, revealing the resultant curve only. Band highlights the current band inside the graph.

NOTE: Feedback Suppressor modules use a hefty amount of processing power and are limited to a maximum of sixteen bands, although, in practice the number of bands actually in use will often be fewer. The Feedback Suppressor's active bands can also be recreated within a Parametric Equalizer to save DSP resources.

3.4 Filters

Filter modules provide **High Pass**, **Low Pass**, **High Shelf**, **Low Shelf** and **All-Pass** filters for applications that require rolling off of frequencies, simple tone controls, or phase compensation.

Filters may be connected between any components within the Build Window.

3.4.1 High Pass

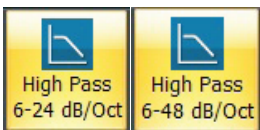

High Pass Module Icons

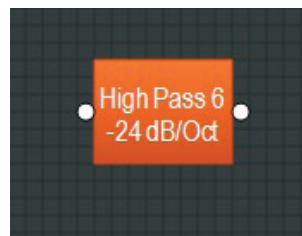

High Pass Component Object

Right-click to access the Component Object's Dialog Box, with the trols:

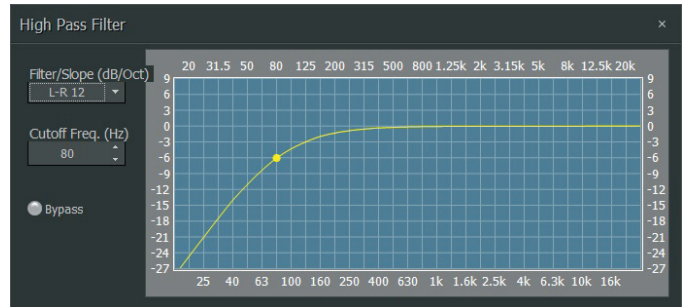

High Pass Dialog Box

- **Filter Slope** selects the filter type (Linkwitz-Riley or Butterworth) and slope of the filter.
- **Cutoff Freq.** selects the cutoff frequency for the filter. Cutoff Freq. may also be adjusted by dragging the cursor shown inside the graph.
- **Bypass** turns the filter on or off.

3.4.2 Low Pass

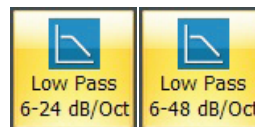

Low Pass Module Icons

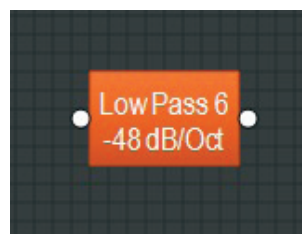

Low Pass Component Object

Right-click to access the Component Object's Dialog Box, with the following controls:

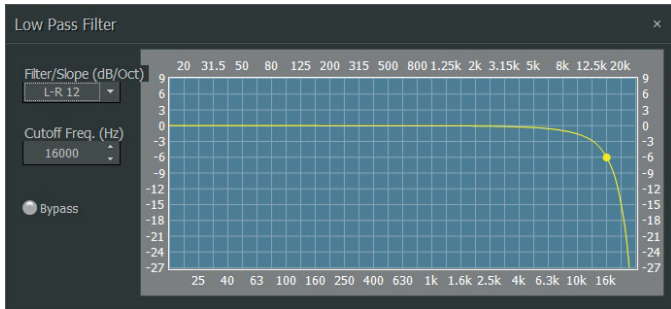

Low Pass Dialog Box

- **Filter/Slope** selects the filter type (Linkwitz-Riley or Butterworth) and slope of the filter.
- **Cutoff Freq.** selects the cutoff frequency for the filter. Cutoff Freq. may also be adjusted by dragging the cursor shown inside the graph.
- **Bypass** turns the filter on or off.

3.4.3 High Shelf



High Shelf Module Icon



High Shelf Component Object

Right-click to access the Component Object's Dialog Box, with the following controls:

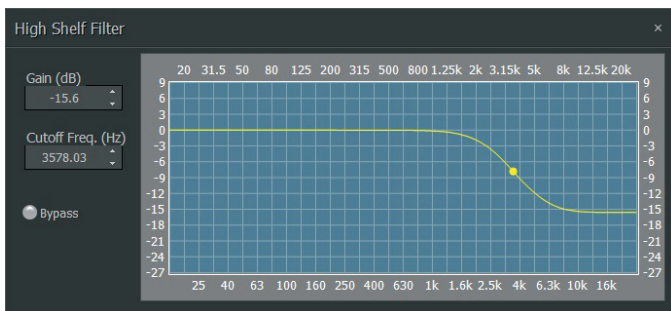

High Shelf Dialog Box

- **Gain** selects the amount of maximum cut or boost applied by the filter.
- **Cutoff Freq.** selects the cutoff frequency for the filter. These settings may also be adjusted by dragging the cursor shown inside the graph.
- **Bypass** turns the filter on or off.

3.4.4 Low Shelf

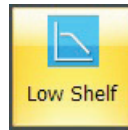

Low Shelf Module Icon



Low Shelf Component Object

Right-click to access the Component Object's Dialog Box, with the following controls:

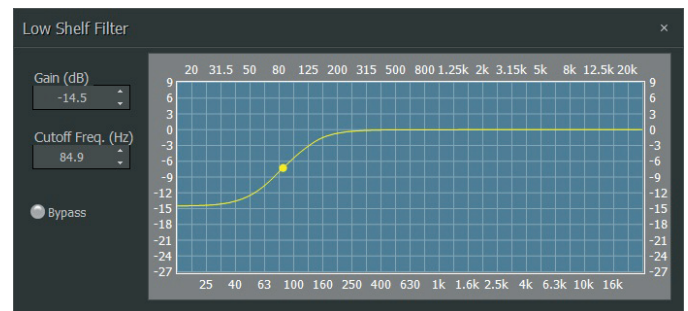

Low Shelf Dialog Box

- **Gain** selects the amount of maximum cut or boost applied by the filter.
- **Cutoff Freq.** selects the cutoff frequency for the filter. These settings may also be adjusted by dragging the cursor shown inside the graph.
- **Bypass** disables the filter without changing settings.

3.4.5 All Pass

All Pass filters affect signal phase instead of frequency response, and All Pass modules can be used to compensate for phase problems sometimes caused by normal equalization filters. All-Pass Filters are available with up to sixteen bands.

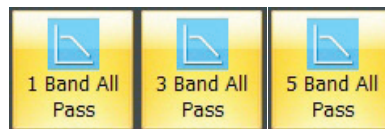

All Pass Module Icons

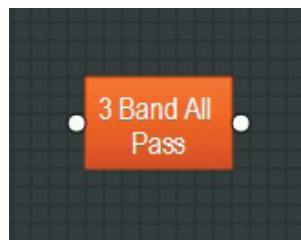

All Pass Component Object

Right-click to access the Component Object's Dialog Box, with the following controls:

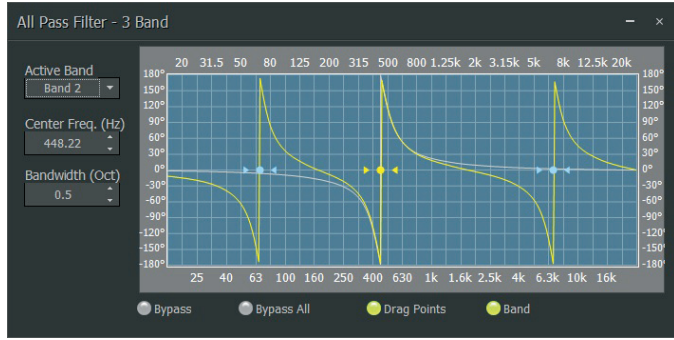

All Pass Dialog Box

- **Active Band** selects the current band to be adjusted.
- **Center Freq.** adjusts the center frequency for the current band.
- **Bandwidth** adjusts the range of frequencies, above and below the center frequency, which are also affected by the current band. These settings may also be adjusted by dragging the band controls shown inside the graph (the drag points turn yellow when selected). Dragging the yellow dot affects Center Freq. Dragging either yellow arrowhead affects Bandwidth.
- **Bypass** and **Bypass All** disables the bands without changing settings.
- **Drag Points** turns on/off the band controls.
- **Band** shows the phase response of the current band inside the graph.

3.5 CrossOvers

Crossovers provide **2-way**, **3-way** and **4-way** crossover functions. Crossovers may be connected between any components within the Build Window, for applications which require multiple outputs with specified frequency ranges.

3.5.1 2-Way/3-Way/4-Way Modules

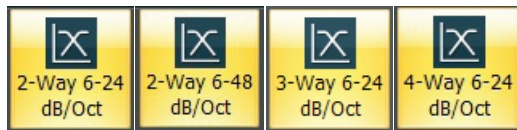

2-Way, 3-Way and 4-Way Crossover Module Icons

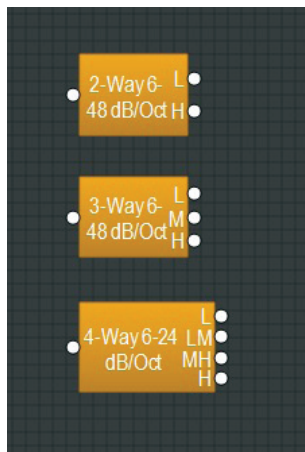

2-Way, 3-Way and 4-Way Crossover Component Objects

Right-click to access the Component Object's Dialog Box, with the following controls:

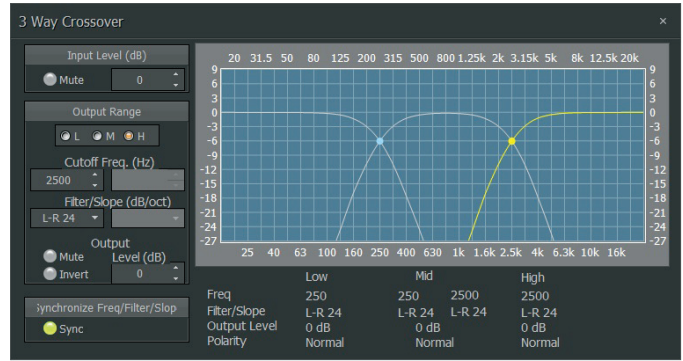

3-Way Crossover Dialog Box

- **Input Level** provides muting and level adjustment for the input.
- **Output Range** selects the Low, Middle or High frequency output.
- **Cutoff Frequency** selects the filter cutoff frequency for the selected output.
- **Output Range** and **Frequency** may also be selected by dragging the cursors shown inside the graph.
- **Filter/Slope** selects the type (Linkwitz-Riley or Butterworth) and slope of filter used at the associated Frequency.
- **Output Level** provides level adjustment, muting and polarity reversal for the selected output.
- **Sync** forces filter adjustments on adjacent outputs to be linked.

Complete settings for each output appear across the bottom of the dialog box.

3.6 Dynamics

Dynamics modules provide **Leveler**, **Complimiter**, **Ducker**, **Noise Gate**, and **ANC (Ambient Noise Compensator)** functions. Dynamics modules may be connected between any other components within the Build Window, for applications which require automatic control of volume levels and/or dynamics.

3.6.1 Leveler

Leveler automatically controls gain to even out long-term average levels.

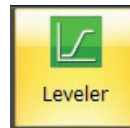

Leveler Module Icon

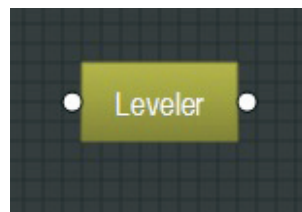

Level Component Object

EN

Right-click to access the Component Object's Dialog Box, with the following controls:

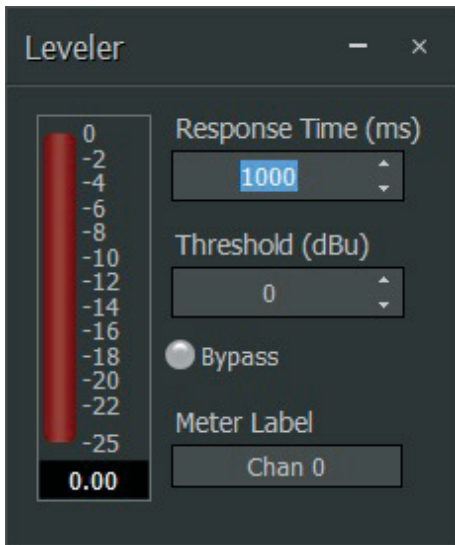

Leveler Dialog Box

- **Response Time** determines how quickly the Leveler reacts to changes in the input level.
- **Threshold** determines the minimum input level that will trigger gain reduction. To maintain a consistent level, set Threshold to the lowest desired level. A meter and numeric display show the amount of gain reduction when the input signal exceeds the threshold.
- **Bypass** deactivates the Leveler and sends the signal straight through without processing. Settings remain the same while bypassed.

3.6.2 CompLimiter

CompLimiter modules even out short-term dynamic peaks in the input signal.

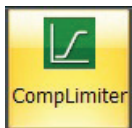

CompLimiter Module Icon

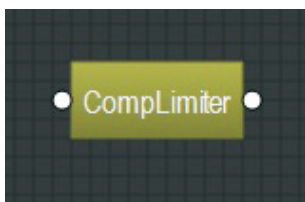

CompLimiter Component Object

Right-click to access the Component Object's Dialog Box, with the following controls:

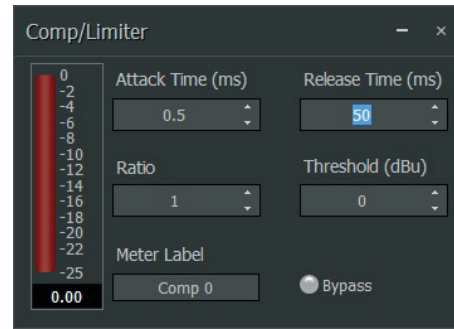

CompLimiter Dialog Box

- **Attack Time** controls how quickly the Comp/Limiter responds to input level changes.
- **Ratio** determines the intensity of gain reduction (input level increase vs. output level increase).
- **Release Time** determines how quickly gain reduction is released, once input signal falls below Threshold.
- **Threshold** determines what input level will trigger gain reduction. A meter and numeric display indicate the amount of gain reduction.
- **Bypass** deactivates the Comp/Limiter and sends the signal straight through without processing. Settings remain the same while bypassed.

3.6.3 Ducker

Ducker attenuates the input level when triggered by an additional signal or logic input.

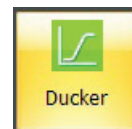

Ducker Module Icon

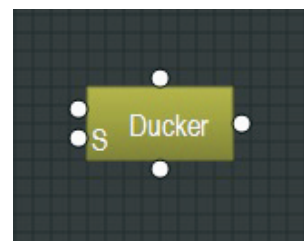

Ducker Component Object

Right-click to access the Component Object's Dialog Box, with the following controls:

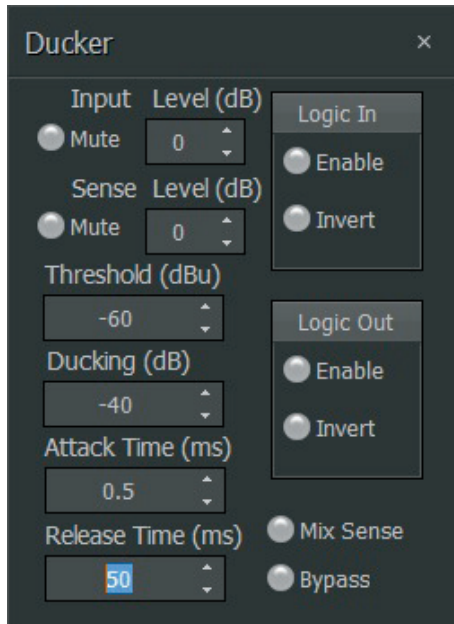

Ducker Dialog Box

- **Input Level** provides muting and level adjustment for the primary audio input (the upper input terminal on the left side of the Ducker).
- **Sense Level** provides muting and level adjustment for the secondary "trigger" signal input (the lower input terminal marked "S" on the left side of the Ducker).
- **Threshold** controls the level at which the secondary audio signal will trigger ducking.
- **Ducking Level** controls how much attenuation is applied to the primary audio signal during ducking.
- **Attack Time** determines how quickly the ducker responds to the secondary audio or logic "trigger" signal.
- **Release Time** controls how quickly the ducker effect lets go of the primary audio signal.
- **Logic In** turns the logic input on/off and can invert the logic signal, if necessary.
- **Logic Out** allows the ducker to send out its own logic signal to another device.
- **Mix Sense** enables the ducker to detect a "trigger" signal within a mix of multiple audio signals.

3.6.4 Noise Gate

Noise Gate provides automatic muting, until the gate is triggered and opened by an incoming audio signal.

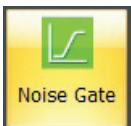

Noise Gate Module Icon

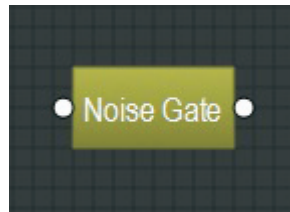

Noise Gate Component Object

Right-click to access the Component Object's Dialog Box, with the following controls:

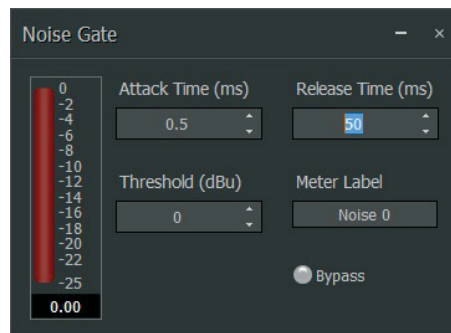

Noise Gate Dialog Box

- **Attack Time** controls how quickly the gate opens when a signal is present at the input.
- **Release Time** controls how quickly the gate closes when a signal is no longer present.
- **Threshold** sets the input signal level that will trigger the gate to open. A meter and numeric display indicate the amount of gain reduction.
- **Meter Label** lets you name and identify the source of the input signal.
- **Bypass** switches the Noise Gate on or off.

3.6.5 ANC (Ambient Noise Compensator)

3.6.5.1 ANC Module (Ambient Noise Compensator)

ANC (Ambient Noise Compensator) automatically adjusts volume when triggered by changes in background noise levels, as measured by an external ambient sensing microphone.

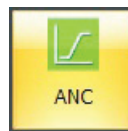

ANC Module Icon

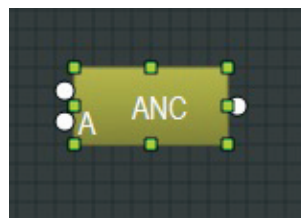

ANC Component Object

Right-click to access the Component Object's Dialog Box, with the following controls:

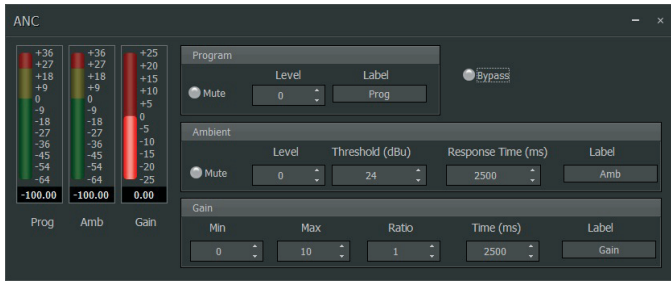

ANC Dialog Box

NOTE: The primary signal is referred to as the “Program” signal, while the secondary reference signal is referred to as the “Ambient” signal.

- **Program Mute** turns the input signal on or off.
- **Program Level** adjusts the relative input volume.
- **Program Label** provides a customizable label for the source of the primary Program input signal.
- **Prog Meter** displays the current input level.
- **Ambient Mute** turns the ambient input signal on/off.
- **Ambient Level** adjusts the input volume for the Ambient input.
- **Ambient Threshold** sets the Ambient noise level at which gain increases are applied to the Program signal.
- **Ambient Response** sets the time period during which the ANC module calculates the working average of Ambient level fluctuations.
- **Ambient Label** provides a customizable label for the Ambient signal source.
- **Amb Meter** displays the current Ambient input level.
- **Gain Min** determines the minimum Program output gain for periods of low ambient noise.
- **Gain Max** determines the maximum Program output gain for periods of high ambient noise.
- **Gain Ratio** determines how much the Program volume will increase in response to a given noise increase in the Ambient reference signal.
- **Gain Time** determines the amount of time required for the Program gain to change between Min and Max settings.
- **Gain Meter** displays the current gain compensation being applied to the Program signal.
- **Bypass** switches off the Ambient Noise Compensator.

3.6.5.2 Making Connections

1. Route the Program signal into the Program Input terminal (top left) on the ANC Component Object and set the input gain (see “Setting Gain Min and Gain Max” below).
2. Route the Ambient signal into the Ambient Input (bottom left, marked with an “A”) on the ANC Component Object. This Ambient signal should be derived from either a single dedicated sensing microphone, or from an array of sensing microphones feeding a common Mixer module. For best results, the ANC Ambient levels should be set when the ambient noise in the room is minimized and the Amb Meter reads at least -60 dBu.

3. Connect the ANC Component Object's output terminal to the input terminal of the final Output Component Object in the signal path (DM8000 Output 6 Channel, UltraNet Out, or USB Out).. ANC should be the last Component Object in the signal path before routing the signal to outputs. For consistent performance once levels have been set, do not subsequently adjust the level settings at the outputs, amplifiers, or speakers.

3.6.5.3 Setting Gain Min and Gain Max

For best results, you should set Program gain levels by using a relatively constant Program source signal. If the actual source Program signal is not constant enough, pink noise can also be used to set levels (provided the pink noise approximates the highest Program level that you expect will be routed into the ANC module).

1. Adjust the Gain Min and Gain Max levels to your desired settings for the Program signal. Note that the Gain Min setting represents the minimum constant gain that the ANC module will apply to the Program input signal when the Ambient signal level drops below the Ambient Threshold. Similarly, the Max Gain setting represents the maximum amount of gain that you expect the ANC module will ever apply to the Program input level.
2. If Gain Min and Gain Max are not known in advance, you may determine these settings by monitoring the ANC output using this procedure:
 - a. Set the Ambient Threshold to the maximum setting (+24 dBu) to make sure the Ambient Input level is below threshold. This maximum Ambient Threshold setting automatically adjusts the ANC module to the Min Gain setting. Remember that the Gain Time setting controls how quickly the ANC module moves the Ambient signal to the Min Gain setting.
 - b. Adjust Gain Min until you find the desired maximum output level.
 - c. Set Gain Max to the output value you have just discovered using Gain Min.
 - d. Re-set Gain Min to the value determined in Step 2a.
 - e. Adjust Gain Min until you have the desired minimum Program level coming out of the ANC module. Note this Gain Min setting for later use.

3.6.5.4 Setting Response Times

1. Adjust Gain Time to figure out how quickly the ANC gain is changing. Gain Time determines how quickly the ANC module moves from Gain Min to Gain Max, or vice versa.
2. Adjust the Ambient Response setting to discover how quickly the ANC module responds to changes in the Ambient input level. Ambient Response should be set fast enough to respond to significant and sustained changes in the Ambient signal level, but slow enough to disregard short, transient changes in the Ambient signal level, such as coughs, bumps, popping sounds or dropped objects.

NOTE: The ANC module's overall responsiveness is controlled by either the Gain Time setting or Ambient Response setting, whichever is larger/slower.

3.7 Routers

Router modules offer audio routing and switching functions from simple source selection and signal-splitting to complicated input/output matrices. Routers may be placed between any other components to control signal flows.

3.7.1 In/Out Routers

In/Out Routers let you route multiple input signals to multiple output terminals by using an assignable matrix. In/Out Routers can duplicate input signals in a way similar to a splitter or distribution amplifier.

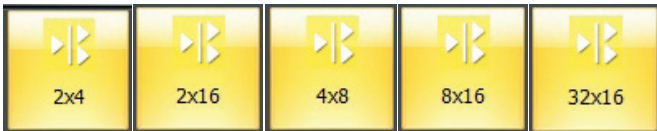

In/Out Router Module Icons

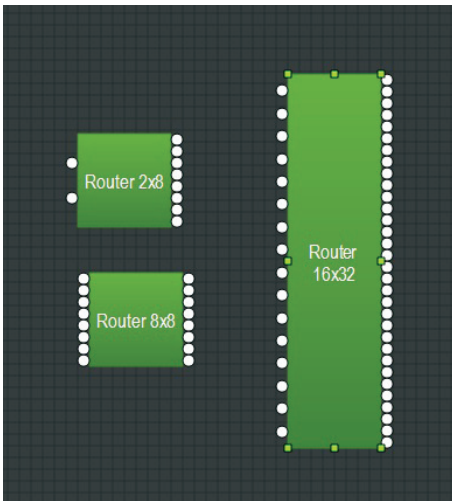

In/Out Router Component Objects

NOTE: In/Out Router inputs can each be individually assigned to multiple outputs, but each individual output can only accept a single input signal.

Right-click to access the Component Object's Dialog Box, with the following controls:

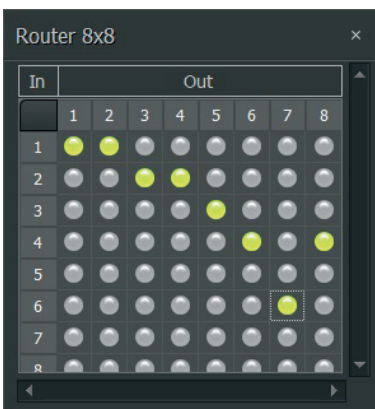

In/Out Router Dialog Box

- **In** channels appear as a column on the left side of the routing matrix.
- **Out** channels appear in a row along the top of the routing matrix.
- To assign an input signal to an output, click on the matrix node located where the **In** row intersects with the **Out** column. When selected, the matrix node lights green.

3.7.2 Source Selection

Source Selection modules allow you to route multiple audio inputs sent to a single output. Only one source input at a time can be active.

Right-click to access the Component Object's Dialog Box, with the following controls:



Source Selection Dialog Box

- **Level** controls the input gain.
- **Source** nodes, when clicked, activate their matching input source and light green. Only one source input can be active at any time.
- **Label** allows you to create a custom label for each input.

To enable logic inputs and outputs, right-click over the Component Object, select Parameters from the pop-up menu to launch a dialog box with the following controls:

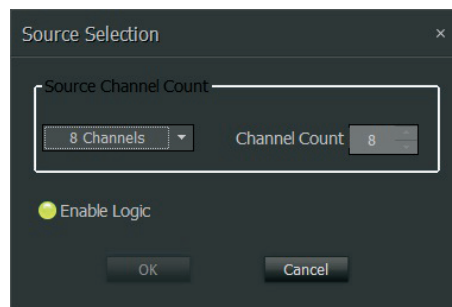

Source Selection Parameters Dialog

- **Enable Logic** activates the logic inputs and outputs. Logic input/output terminals will then appear on the top and bottom of the Component Object.
- **Source Channel Count** pulldown menu lets you alter the number of inputs after you have placed the Source Selection model in the build window.

3.8 Delays

Delay modules provide audio time delay functions for applications such as time alignment of loudspeakers over distance.

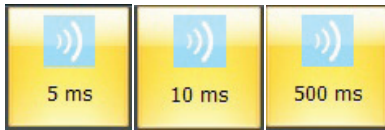

Delay Module Icons

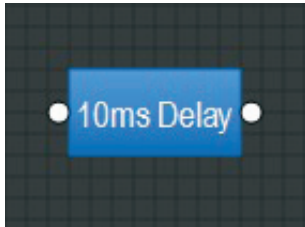

Delay Component Object

Delay modules may be placed between any components within the Build Window.

Right-click to access the Component Object’s Dialog Box, with the following controls:

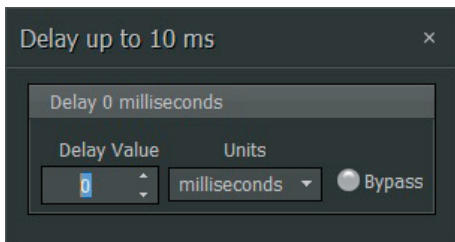

Delay Dialog Box

- **Delay Value** sets the amount of time delay.
- **Units** selects the type of unit used by Delay Value, either time (milliseconds) or distance (meters, centimeters, feet, or **inches**).
- **Bypass** switches the Delay module on or off.

3.9 Controls

Controls modules offer more detailed channel strip functions than the Router and Source Selection modules. These functions include more flexible level control, phase inversion, muting, logic-controlled switching and “ganging” of multiple inputs to a single fader.

3.9.1 Level Control

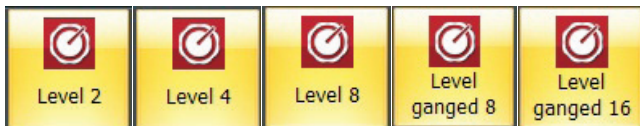

Level Control Module Icons

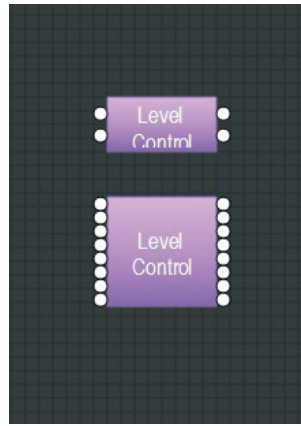

Level Control Component Objects

Right-click to access the Component Object’s Dialog Box, with the following controls:



Level Control Dialog Box

- **Mute** turns individual channels on or off.
- **Channel** level controls may be manually adjusted by dragging the fader, or the level value may be entered in as a numerical value.
- **Maximum** and **Minimum** level values can be used to restrict a channel fader’s range of level adjustment.
- **Level Label** lets you create a custom label for channel.

Channel level controls can also be grouped or “ganged” onto a single fader.

Ganged Level Control modules are available in the Module Library, but regular Level Control modules can also be ganged after being placed in the Build Window.

To activate ganging in an already-placed Level Control module, right-click over the Level Control Component Object in the Build Window, and then choose Parameters from the pop-up menu to access the **Gang Controls** setting:

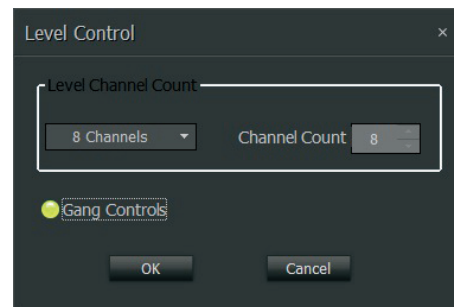

Level Control Parameters Dialog Box with Gang Controls selected

Gang Controls button will light green when activated, and the Component Object in the Build Window will display a "G":

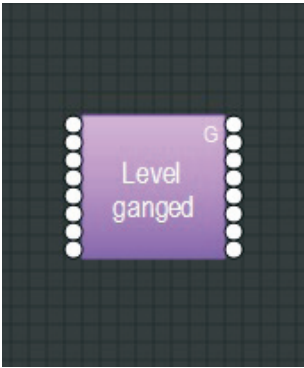

Ganged Level Control Component Object with "G"

The Level Control Dialog Box, when opened, will subsequently show a single channel strip for all of the ganged inputs:

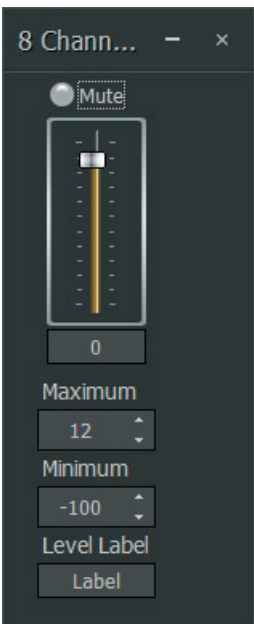

Level Control Dialog Boxed with Ganged Channel Controls

3.9.2 Level Inc/Dec

Level Inc/Dec modules provide Logic control terminals for incremental level changes, but are otherwise identical to Level Control modules.

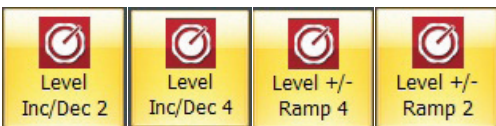

Level Inc/Dec Module Icons

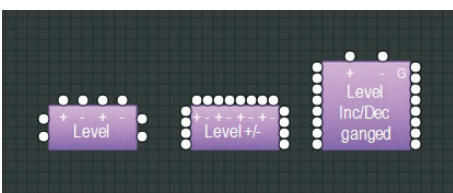

Level Inc/Dec Component Objects

Right-click to access the Component Object's Dialog Box, with the following controls:



Level Inc/Dec Dialog Box

- **Mute** turns individual channels on or off.
- **Channel Level Controls** may be manually adjusted by dragging the fader, or the level value may be entered in as a numerical value.
- **Maximum** and **Minimum** level values can be used to restrict a channel fader's range of level adjustment.
- **Inc/Dec** controls the amount of level change that happens each time the respective logic control terminal is triggered. Logic input terminals along the top of the Component Objects display positive (+) and negative (-) labels. Signals from the positive (+) logic terminals increase the level by the programmed Inc/Dec value. Similarly, signals from the negative (-) logic terminals decrease the level by the same Inc/Dec value.
- **Level Label** lets you add a custom label to each channel.

Similar to the Level Control Modules, multiple channel controls can be "ganged" together onto a single fader. Ramping can also be enabled.

Level Inc/Dec modules with ganging and ramping pre-enabled are available in the Module Library, but ganging and ramping can also be enabled after the module is placed in the Build Window.

To activate ganging and/or ramping in an already-placed Level Inc/Dec module, right-click over the module's Component Object in the Build Window, and then choose Parameters from the pop-up menu to access the **Gang Controls** and **Enable Ramping** settings:

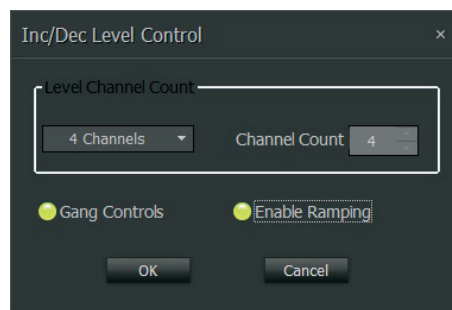

Level Inc/Dec Parameters Dialog Box with Gang Controls and Enable Ramping selected

- **Gang Controls** button will light green when activated, and the Component Object in the Build Window will display a "G":

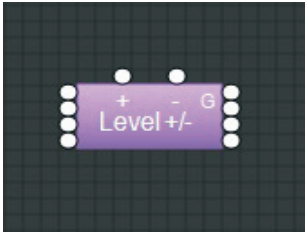

Ganged Level Inc/Dec Component Object with 'G'

- **Enable Ramping** activates automatically-repeating Inc/Dec steps that continue as long as the respective logic control terminal, either positive (+) or negative (-), remains active.

Right-click over the Component Objects again to see how the Dialog Box changes when Gang Controls and Enable Ramping are active:

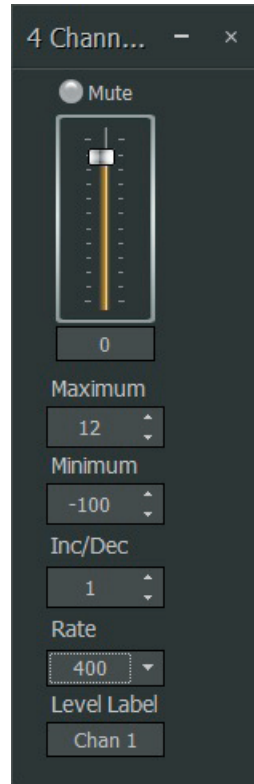

Level Inc/Dec Dialog Box with Ganging and Ramping enabled

When Gang Controls is selected in the Parameters dialog, the main Level Inc/Dec Dialog Box will show a single fader for all channels. (If Enable Ramping has also been selected, a single Rate parameter will be applied to all of the ganged channels.)

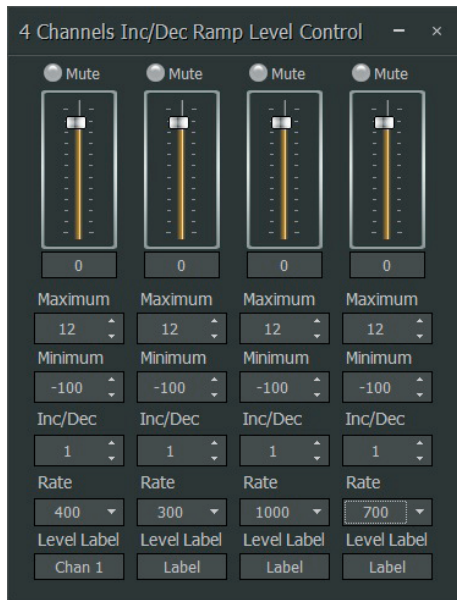

Level Inc/Dec Dialog Box with Ramping per channel

When Enable Ramping is active, the main Level Inc/Dec Dialog Box will show a new parameter for each channel:

- **Rate** sets the timing in milliseconds between the repeating incremental level changes used in the ramping process.

3.9.3 Invert

Invert modules reverse the audio signal's polarity by 180°.



Invert Module Icons

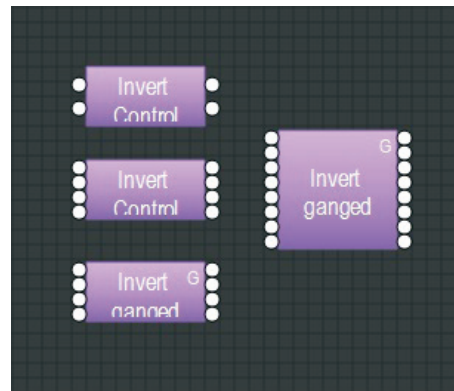

Invert Component Objects

Right-click to access the Component Object's Dialog Box, with the following controls:

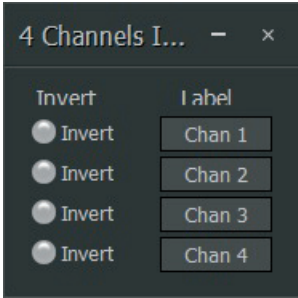

Invert Dialog Box

- **Invert** flips the polarity for the selected channel.
- **Label** lets you create a custom label for each input.

As with other modules, ganged Invert modules are available in the Module Library, but the channels in an Invert module can still be ganged after the module is placed in the Build Window by right-clicking to access the Parameters dialog box:

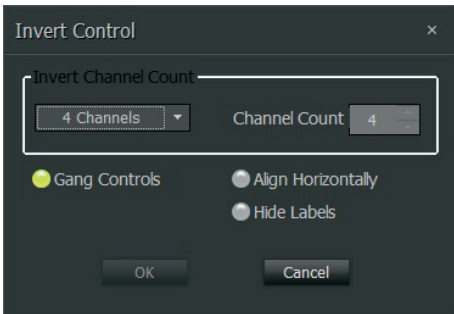

Invert Parameters Dialog Box with Gang Controls enabled

When **Gang Controls** has been enabled, the related Component Object will show a "G", and the Invert Control Dialog Box will show a single Invert control for all of the channels:

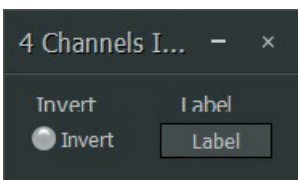

Invert Control Dialog with Ganged channels

3.9.4 Mute

Mute modules turn connected audio channels on or off.

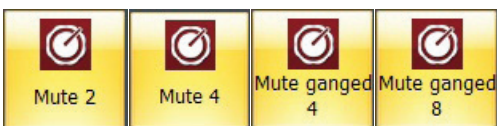

Mute Module Icons

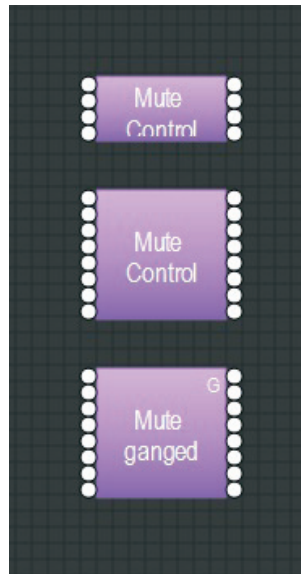

Mute Component Objects

Right-click to access the Component Object's Dialog Box, with the following controls:

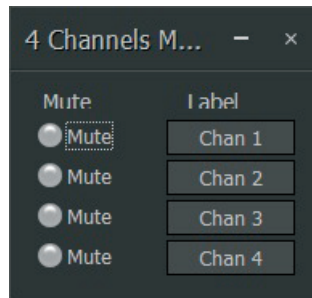

Mute Control Dialog Box

- **Mute** switches off the selected channel.
- **Label** lets you create a custom label for each input.

As with other modules, ganged Mute modules are available in the Module Library, but the channels in a Mute module can still be ganged after the module is placed in the Build Window by right-clicking to access the Parameters dialog box:

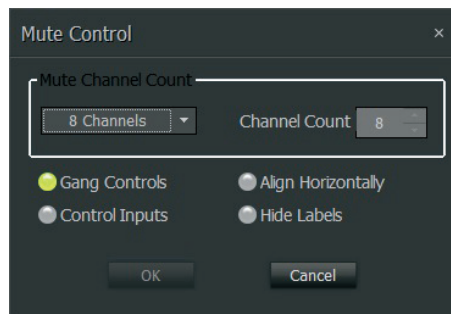

Mute Parameter Dialog Box with Gang Controls

EN

When **Gang Controls** is enabled, the Mute Control Dialog Box will show a single Mute control for all channels:



Mute Control Dialog Box with Gang Controls enabled

Mute modules can also be set up with logic control terminals by going to the Parameters Dialog Box and enabling the **Control Inputs** option:

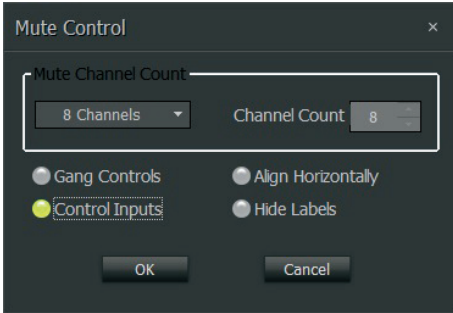

Mute Parameter Dialog Box with Control Inputs enabled.

When **Control Inputs** is enabled, the Mute Component Object will display logic control terminals along the top, one logic terminal for each audio channel:

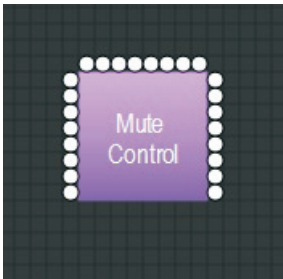

Mute Component Object with Logic Terminals

Gang Controls and Control Inputs can both be enabled at the same time, in which case the Mute Component Object will display a 'G' and a single logic terminal along the top:

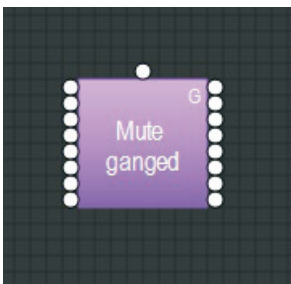

Mute Component Object with Ganged Logic Terminal

3.9.5 Logic Gates

Logic Gates can be placed between the logic output and logic input terminals of other modules in the Build Window. Logic Gates can also be used to manage control signals from GPIO connections and integrate those GPIO signals into the DSP processing.



Logic Gate Module Icons

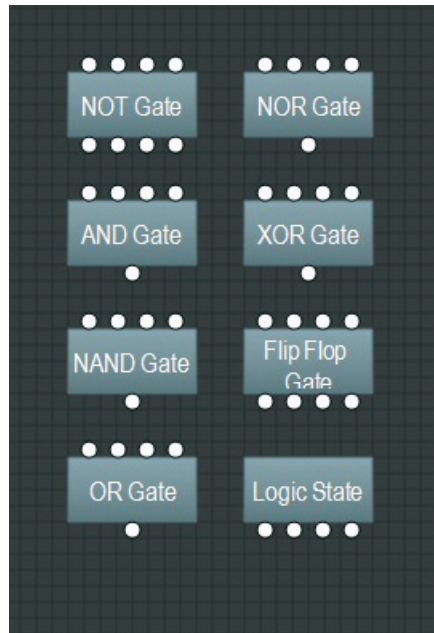

Logic Gate Component Objects

Logic Gate modules function in the following ways:

- **NOT** inverts logic command cues (e.g., a HIGH input exits the module as a LOW output, while a LOW input is inverted into a HIGH output).
- **AND** triggers a single output of matching polarity when ALL of the inputs are the same (i.e., when all inputs are HIGH, the module produces a single HIGH output; When all inputs are LOW, the module produces a single LOW output).
- **NAND** produces a single LOW output when ALL inputs are HIGH, while one or more LOW inputs triggers a HIGH output.
- **OR** produces a single LOW output when ALL inputs LOW, while one or more HIGH inputs triggers a HIGH output.
- **NOR** produces a single HIGH output when ALL inputs are LOW, while one or more HIGH inputs triggers a LOW output.
- **XOR** produces a single LOW output when ALL inputs are LOW or HIGH. HIGH inputs triggers a single HIGH output, but only when NOT ALL inputs are HIGH (e.g., in a four-input XOR module, when three out of four inputs are HIGH, the output will be HIGH; However, whenever ALL four inputs are HIGH, the output will be LOW).
- **Flip Flop** behaves like a toggle or latching switch where a HIGH input changes the output state, depending on how the output has been set (e.g., when the output is set to HIGH, a HIGH input changes the output to LOW; When the output is set to LOW, a HIGH input changes the output to HIGH).
- **Logic State** modules act as manual toggle or latching switches. Logic State modules do not have input terminals.

NOTES:

- Only **NOT** and **Flip Flop** modules have matching one-to-one inputs for every output, while other gate types have multiple inputs for a single output.
- Only **Flip Flop** and **Logic State** modules have Control Dialog Boxes, which are used to set these modules' initial HIGH or LOW states.

- Multiple **Flip Flop** input terminals can be connected to a single output from another logic Gate module.

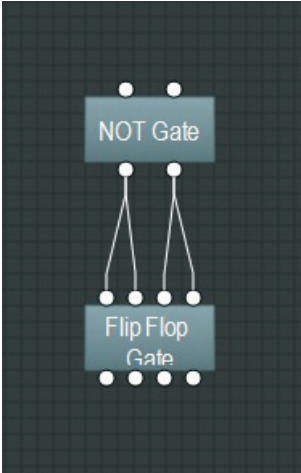

NOT Outputs Connected to Multiple Flip Flop Inputs

Right-click over a Flip Flop or Logic State Component Object to access the Control Dialog Boxes:

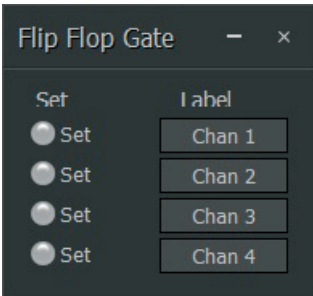

Flip Flop Gate Dialog Box



Logic State Dialog Box

In both of these Control Dialog Boxes, click on an individual channel's Set node to set that channel to a HIGH state. The nodes will light up green when selected.

3.9.6 Logic Delays

Logic Delays use a set time threshold to filter and delay logic control signals. When a logic command (on or off) arrives at a Logic Delay input terminal, the Logic Delay module waits to see if the control signal persists beyond the user-programmed amount of time. If the control signal continues beyond the set time threshold, the Logic Delay will then output a signal of the same on or off type. Logic control signals that do not persist beyond the set time threshold are not passed on.

Logic Delay modules are placed in between the logic control terminals of other logic modules and/or audio modules that generate or accept logic control signals.



Logic Delay Module Icons

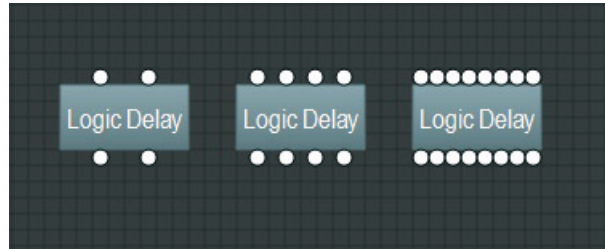

Logic Delay Component Objects

Right-click to access the Component Object's Dialog Box, with the following controls:

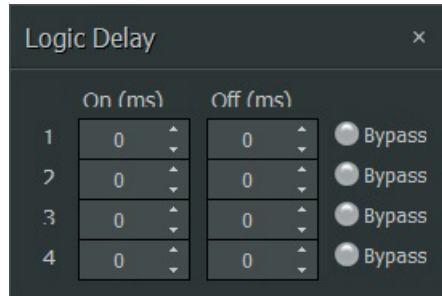

Logic Delay Control Dialog Box

- On** sets the time threshold for an "On" control signal. The On delay time can be up to 60,000 ms/ 1 minute.
- Off** sets the time threshold for an "Off" control signal. The Off delay time can be up to 60,000 ms/ 1 minute.
- Bypass** switches off the delay function for the given channel.

3.9.7 Preset Buttons

Preset Buttons can be placed in the Build Window and programmed to set up and recall user-created setting presets.

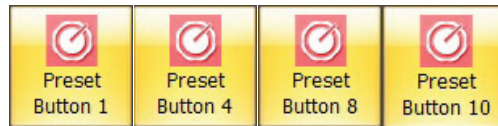

Preset Button Module Icons

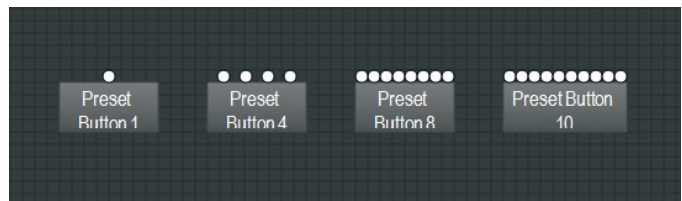

Preset Button Component Objects

Right-click to access the Component Object's Dialog Box, with the following controls:

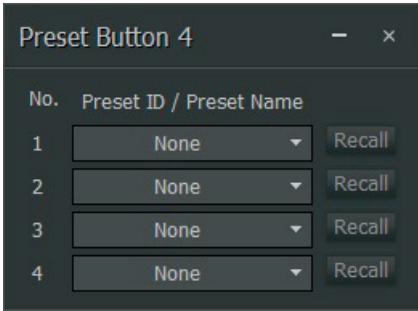

Preset Button Dialog Box

Right-clicking over a button provides a list of available

- **Preset ID / Preset Name** pull-down menus allow you to select a user-created Preset from the Preset list.
- **Recall** buttons activate and deploy the matching Preset.

3.9.8 GPIO

GPIO modules allow the DM8000 DSP to interface with external GPIO (General Purpose Input Output) controllers via the DM8000's GPIO port on the hardware unit's back panel. The GPIO port supports 6 pins that the user can configure and connect to the **GPIO Volume**, **GPIO Select** or **GPIO Logic Output** modules.



GPIO Module Icons

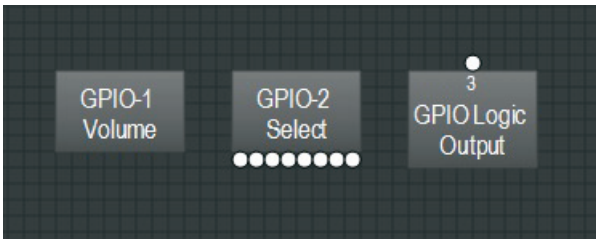

GPIO Component Objects

Unlike other Modules, GPIO automatically launch Parameter Dialog Windows when placed into the Build Window, so that you can assign the GPIO modules to specific GPIO pins in the DM8000's GPIO port on the unit's back panel.

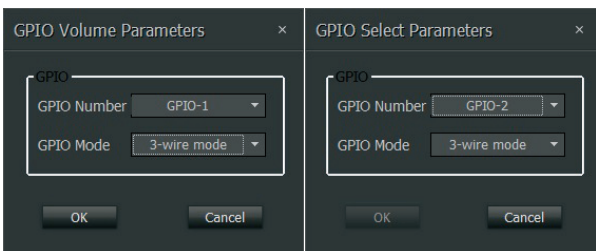

GPIO Volume Parameters and GPIO Select Parameters Dialog Boxes

The GPIO Volume Parameters and GPIO Select Parameters Dialog Boxes contain two pull-down menus:

- **GPIO Number** allows you to assign the module to one of the six available pins in the GPIO port.
- **GPIO Mode** allows you to select between 3-wire and 2-wire configurations.

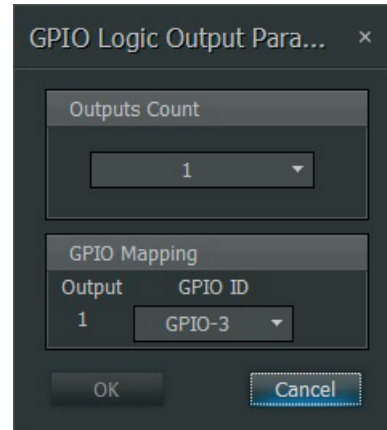

GPIO Logic Output Parameters Dialog Box

The GPIO Logic Output Parameters Dialog Box contains two menus:

- **Outputs Count** allows you to select up to five logic outputs to the GPIO.
- **GPIO Mapping** allows you to assign each logic output to a specific GPIO pin on the back panel GPIO port. When more than one logic output is specified in the Outputs Count pull-down menu, the GPIO Mapping section will automatically add matching pull-down menus for each logic output.

Only the **GPIO Volume** module has a matching Control Dialog Box.

Right-click over the GPIO Volume Component Object to access the Control Dialog Box with the following controls:

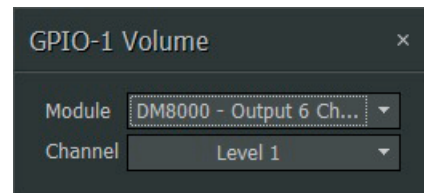

GPIO Volume Control Dialog Box

- **Module** pull-down menu allows you to specify which module in a particular signal processing architecture is to be controlled via GPIO.
- **Channel** lets you select which specific Level or Gain parameter inside the selected module is to be linked and controlled via GPIO. Some modules may contain multiple internal Level and Gain controls.

3.9.9 CP8000

CP8000 modules support MUSIC GROUP's proprietary CP8000 series of controllers.

The CP8000 series controllers (including CP8000UL and CP8000EU) are wall panel accessories for DM8000. The CP8000 control devices allow remote control of volume for DM8000 modules via the DM8000 GPIO port. The DM8000 GPIO port (+5 V and GND) also acts as a remote power supply for CP8000 units.

Take note of the following considerations:

- RVC connects to one of the GPIO pins used for volume adjustment.
- AUX connects to one of the GPIO pins used for selecting which channel's volume is active and available for adjustment.

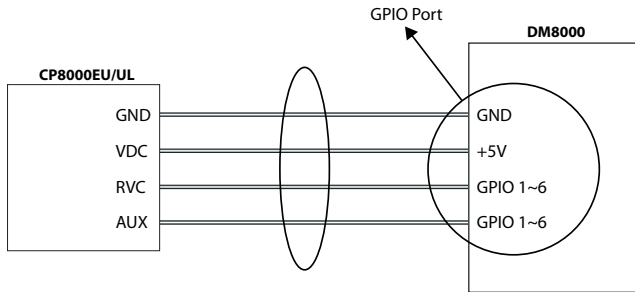

NOTE: Once the CP8000UL/CP8000EU RVC and AUX pins each connect to a specific DM8000 GPIO pin (1 thru 6), those pins cannot be used for other functions.

After connecting CP8000UL/CP8000EU devices to DM8000, the user can then use the DM8000 DSP Designer software to launch dedicated CP8000 modules for remote configuration and control.

CP8000 Dialog Boxes

In the software, when the user chooses a new CP8000 module and drops the module into the Build Window, the software will automatically launch a Parameter Dialog Box so that users may select and designate specific GPIO pins for AUX and RVC.

For example, the following screenshots show the CP8000 AUX pin being assigned to Pin 4 of the DM8000 GPIO port, while the CP8000 RVC pin is assigned to Pin 6:

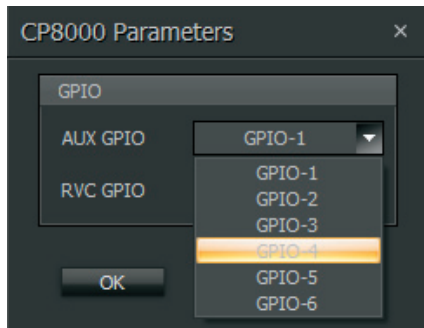

CP8000 Parameters Dialog Box for AUX Pin Assignment to GPIO

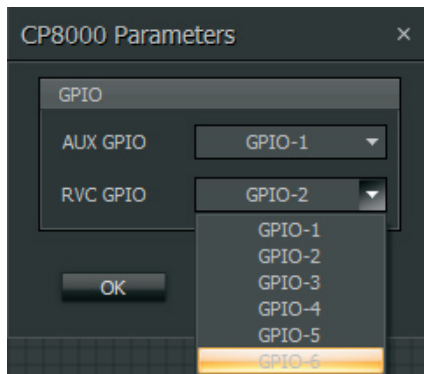

CP8000 Parameters Dialog Box for RVC Pin Assignment to GPIO

After selecting and assigning GPIO pins for AUX and RVC, double-click on the CP8000 module to launch a Control Dialog Box to select which specific Input Output Module (see "3.1 Input Output Modules") will have its volume controlled from the CP8000 series unit.

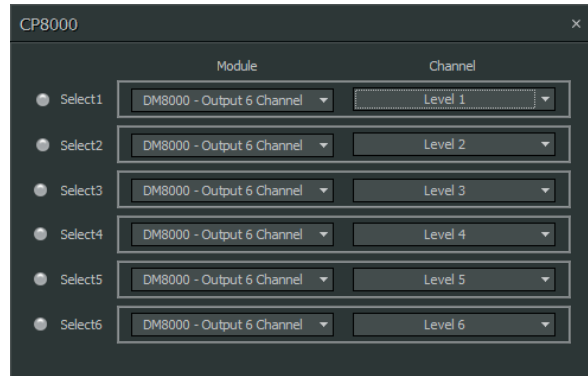

CP8000 Control Dialog Box for Selection of Input Output Module and CP8000 Controller Button

The left-hand Module pulldown menus contain a list of Input Output Modules available for volume control.

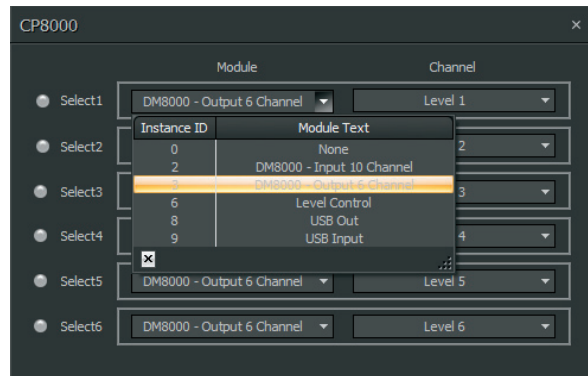

CP8000 Control Dialog Box with Module Pulldown Menu

The right-hand Channel pulldown menus contain a list of CP8000UL/CP8000EU panel buttons available for assignment. (Each CP8000 device has 6 buttons on the front panel available for assignment.)

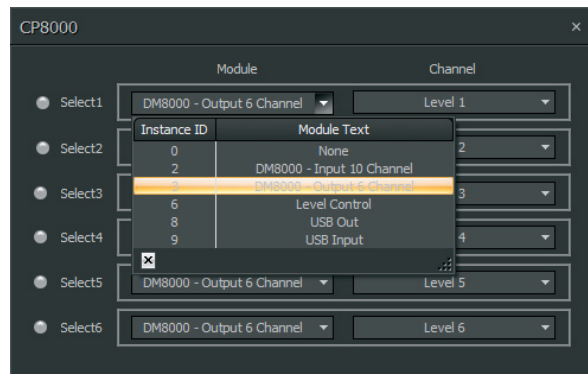

CP8000 Control Dialog Box with Channel Pulldown Menu

After completing the DM8000 system design in the DM8000 DSP Designer software, compile and download to device.

The CP8000 device can now control the assigned volume parameter as designated in the CP8000 module.

CP8000UL/CP8000EU Front Panel

For reference, here are the relevant front panel controls for CP8000UL:

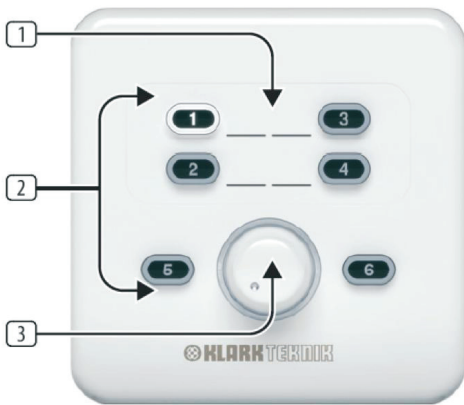
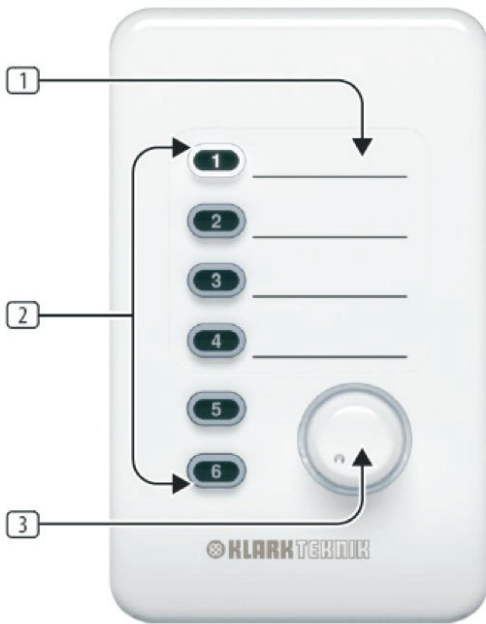

CP8000UL and CP8000EU Front Panels

1. **AUXILIARY INPUT LABELING** area provides space to note the name of the assigned parameter. You may write directly on the surface or apply sticky labels.
2. **SOFT TOUCH BUTTONS** can each be assigned to a separate volume parameter. Press the button to activate the volume parameter assigned to that button. When a button is active, the embedded LED lights up.
3. **VOLUME KNOB** controls the level for the volume parameter selected via the SOFT TOUCH BUTTONS. Whenever a volume parameter has been selected and is active, the LED ring around the VOLUME KNOB will also light up.

In order to select and adjust a volume parameter from CP8000UL/CP8000EU, press the SOFT TOUCH BUTTON assigned to that parameter. Both the button LED and the VOLUME KNOB LED ring will light up to indicate the selected volume parameter is active and ready for adjustment.

3.10 Meters

Meter modules provide **Signal Present, Peak, RMS, and Logic Meter** functions. Meter modules may be connected to any component output terminal, and may be used for diagnostic and setup purposes, or for applications that require real-time metering.

3.10.1 Signal Present Meter

Signal Present Meter modules indicate when an active audio signal is passing through the assigned audio channel. A single Signal Present Meter module can be configured to monitor multiple audio channels at once.



Signal Present Meter Module Icons

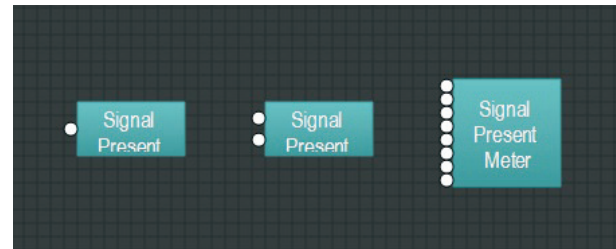

Signal Present Component Objects

Right-click to access the Component Object's Dialog Box, with the following controls:

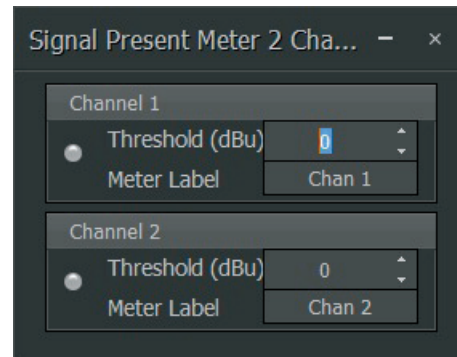

Signal Present Control Dialog Box

- **Threshold** determines at what level the signal present indicator will light.
- **Meter Label** lets you create a custom label for each channel.

3.10.2 Peak Meter

Peak Meter modules are useful for monitoring signal peaks in an audio channel. A single Peak Meter module can be configured to monitor multiple audio channels.

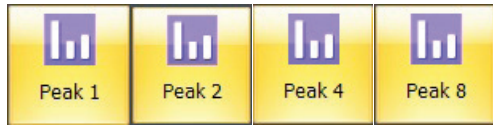

Peak Meter Module Icons

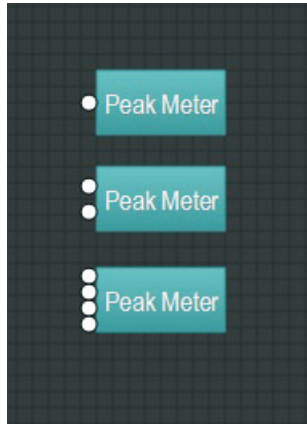

Peak Meter Component Objects

Right-click to access the Component Object's Dialog Box, with the following controls:

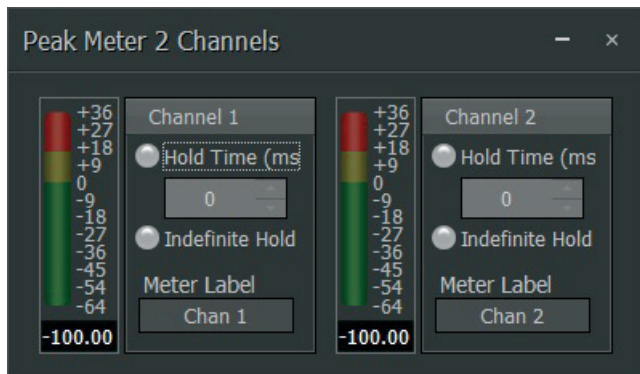

Peak Meter Control Dialog Box

- **Hold Time** controls how long the meter will show the most recent level peak. Click on the matching node to activate the Hold Time function. The node will light green when selected.
- **Indefinite Hold** forces the meter to hold the highest signal peak reading. This highest peak reading will only be updated in the display when a subsequent signal peak exceeds the last highest reading.
- **Meter Label** lets you make a custom label for the audio channel being monitored.

3.10.3 RMS Meter

RMS Meter modules can be used to monitor the average signal level of an audio channel. A single RMS Meter module can be configured to monitor multiple audio channels.



RMS Meter Module Icons

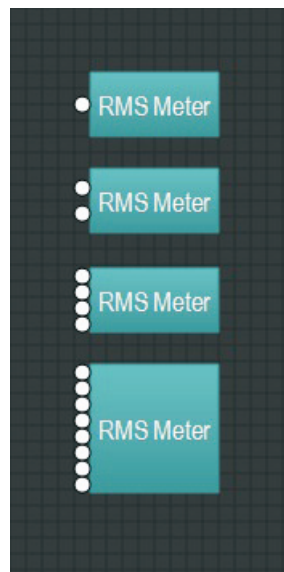

RMS Meter Component Objects

Right-click to access the Component Object's Dialog Box, with the following controls:

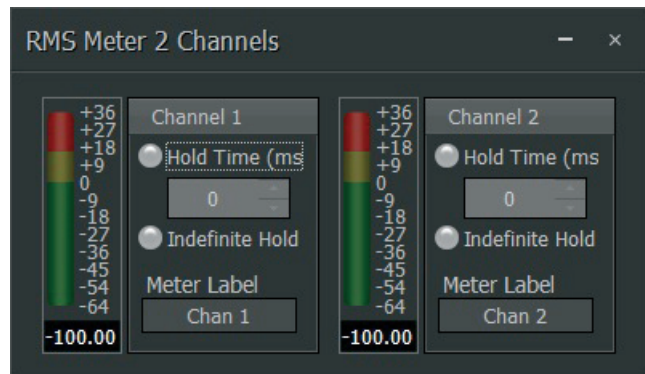

RMS Meter Control Dialog Box

- **Hold Time** controls how long the meter will show the most recent RMS level. Click on the matching node to activate the Hold Time function. The node will light green when selected.
- **Indefinite Hold** forces the meter to hold the highest, most recent RMS reading. This highest RMS reading will only be updated in the display when a subsequent signal peak exceeds the last highest reading.
- **Meter Label** lets you make a custom label for the audio channel being monitored.

3.10.4 Logic Meter

Logic Meter modules allow you to monitor the strength of Logic commands.

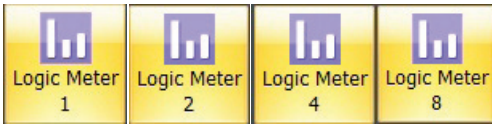

Logic Meter Module Icons

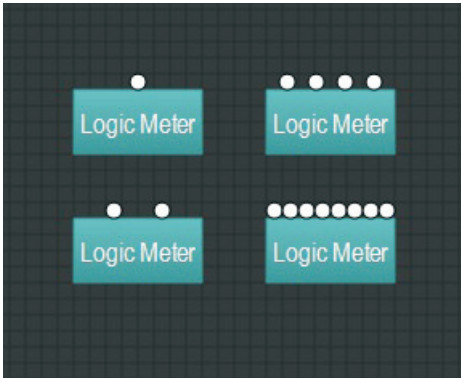

Logic Meter Component Objects

Right-click to access the Component Object's Dialog Box, with the following controls:

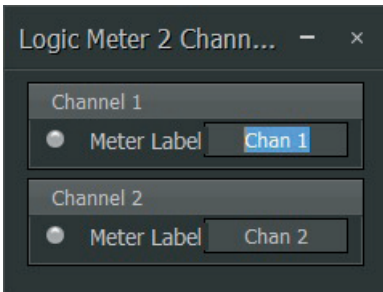

Logic Meter Dialog Box

- **Indicator Node** to the left lights when the logic control input terminal receives a HIGH control signal.
- **Meter Label** lets you create a custom label for the given logic channel.

3.11 Generators

Generators component objects provide sine-wave, sweep, pink-noise, and white-noise generator functions. Generators may be connected to any audio input terminal for diagnostic and setup purposes, or for applications that require tones or to mask other sounds.

3.11.1 Tone Generator

Tone Generator modules can generate a single tone at a set frequency, or they can be used to sweep from a low frequency to a high frequency. These tones can be useful for finding and dealing with problem frequencies in a room or sound system.

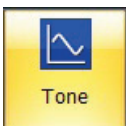

Tone Generator Module Icon

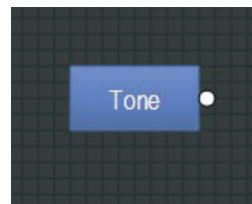

Tone Generator Component Object

Right-click to access the Component Object's Dialog Box, with the following controls:

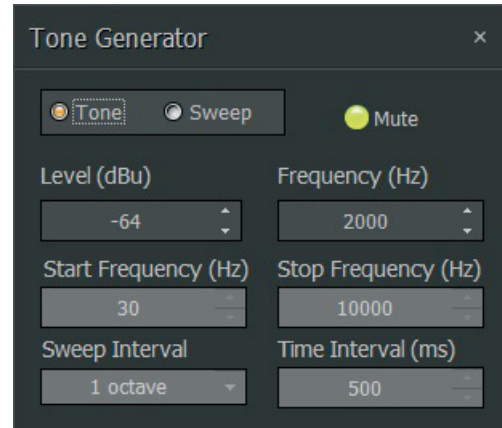

Tone Generator Dialog Box

- **Tone** mode generates a single frequency. Tone mode disables the Start Frequency, Stop Frequency, Sweep Interval and Time Interval parameters.
- **Sweep** mode generates a tone that sweeps through a programmed range of frequencies. In Sweep mode, the Frequency parameter is disabled.
- **Mute** turns the Tone Generator module on or off. The module is muted when the node is lit green.
- **Level** controls the Tone Generator output level.
- **Frequency** sets the single frequency used in Tone mode.
- **Start Frequency** and **Stop Frequency** sets the frequency range for Sweep mode.
- **Sweep Interval** selects the bandwidth for the Sweep tone.
- **Time Interval** sets how long each tone is held during a frequency sweep.

3.11.2 Pink Noise Generator

Pink Noise Generator produces pink noise (equal energy at all octaves), which can be useful as a reference for diagnostics and setting consistent levels by ear.

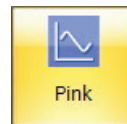

Pink Noise Generator Module Icon

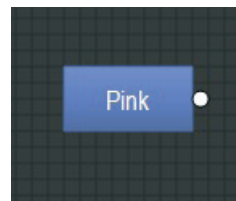

Pink Noise Generator Component Object

Right-click to access the Component Object's Dialog Box, with the following controls:

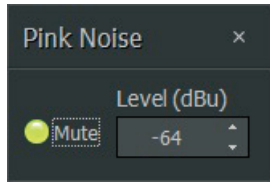

Pink Noise Generator Dialog Box

- **Mute** turns the Pink Noise Generator module on or off.
- **Level** sets the generator output level.

3.11.3 White Noise Generator

White Noise Generator produces white noise (flat frequency spectrum).



White Noise Generator Module Icon

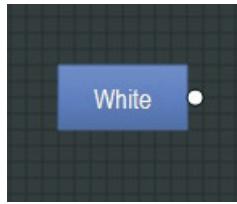

White Noise Component Objects

Right-click to access the Component Object's Dialog Box, with the following controls:

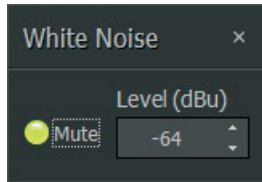

White Noise Dialog Box

- **Mute** turns the White Noise Generator module on or off.
- **Level** sets the generator output level.

4. Building a Signal Processing Architecture

DM8000 Edit Software allows you to build a custom signal processing architecture by pulling connectable drag-and-drop modules from the Module Library into the Build Window. Once in the Build Window, the modules can be arranged and connected to create the desired signal path.

Here is an example of a basic 4-channel mixer architecture:

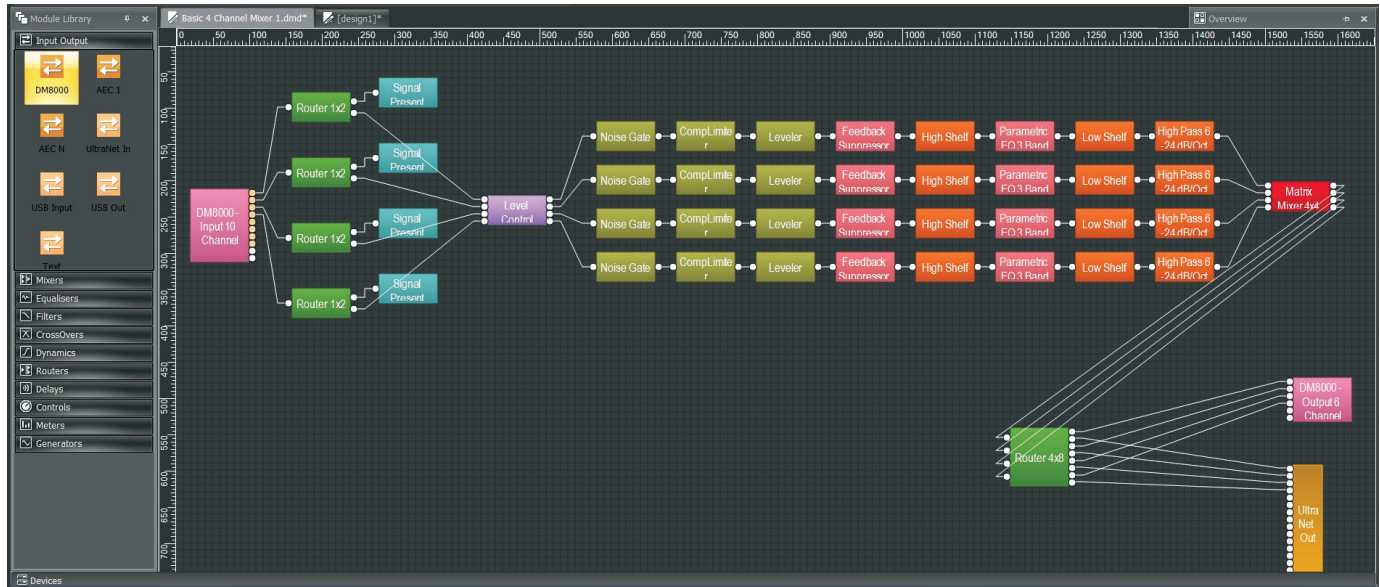

4.1 Deploying Component Objects

To build a custom signal processing architecture, you will need place Component Modules into the Build Window and then connect the related Component Objects together.

Component Objects can be placed in the Build Window by using three methods:

- Drag-and-drop from the Module Library.
- Select Component Modules from the Module Library Toolbar
- Select Component Modules from the Modules pulldown menu at the top of the screen

4.1.1 Drag-and-Drop Method

The drag-and-drop method lets you quickly deploy standardized modules, with minimal time spent choosing options in dialog boxes.

To drag-and-drop Component Modules directly into the Build Window, follow these steps:

1. Go to the left side of the screen and open the Module Library of your choice.
2. Within the Module Library, click on the icon representing the desired module.
3. While holding the mouse button, drag the module into the Build Window.
4. Place the mouse cursor over the desired location in the Build Window.
5. Release the mouse button, and the system will unzip the module and place the module's Component Objects in the chosen location.
6. Once deployed inside the Build Window, the Component Objects can then be moved around on the grid as desired.

4.1.2 Module Library Toolbar Method

The Module Library Toolbar method is good when you want to customize the Component Objects' configuration. Choosing this method means you can close the Module Library on the left side of the screen and therefore open up more space in the Build Window for larger processing architectures.

To select Component Modules using the Module Library Toolbar, follow these steps:

1. Click on the desired Component Module category in the Module Library Toolbar (the categories are indicated by representative icons).
2. Clicking on the Module Library Toolbar icon launches a sub-menu showing the various sub-categories.
3. Within the sub-menu category, click on the desire Component Module sub-category.
4. Place the cursor over the desired location in the Build Window grid and click.
5. Clicking launches a dialog box, where you can choose customizable options.
6. Click OK, and the system will place a Component Object with the selected, customized properties in the chosen location.
7. Once deployed inside the Build Window, the Component Objects can then be moved around on the grid as desired.

4.1.3 Pulldown Menu Method

The Pulldown Menu method offers customization of Component Objects, as well as maximum space in the Build Window to build large processing architectures. By strictly using the pulldown menus, the Module Libraries and Toolbars can be hidden to provide the maximum available space for the Build Window.

To select Component Modules from the standard pulldown menus at the top of the screen, follow these steps:

1. Click on the Modules pulldown menu tab.
2. Select the appropriate sub-menu category.
3. Within the sub-menu category, click on the desire Component Module sub-category.
4. Place the cursor over the desired location in the Build Window grid and click.
5. Clicking launches a dialog box, where you can choose customizable options.
6. Click OK, and the system will place a Component Object with the selected, customized properties in the chosen location.
7. Once deployed inside the Build Window, the Component Objects can then be moved around on the grid as desired.

8. Modifying Modules in the Build Window

Once Component Modules have been placed in the Build Window, you can still modify the Modules' configuration. Further modifications can be made even after the processing architecture has been compiled.

To modify Component Modules that have already been placed in the Build Window, follow these steps:

1. Right-click over the Component Object in the Build Window, which will launch a menu next to the cursor.
2. Click on Parameters to open the configuration dialog box.
3. Once you have chosen new parameters for the Module, click OK, and the Component Object in the Build Window will change to show the new configuration.
4. To exit without modifications, click on Cancel.

4.1.4 Arranging Component Objects in the Build Window

The various Component Objects inside the Build Window can be visually arranged in a variety of ways using automated commands from the Layout Pulldown Menu or the Module Library Toolbar:

- **Order** contains further sub-commands for changing the stacking order of Component Objects in the Build Window, including Bring to Front, Send to Back, Bring Forward and Send Backward.
- **Pack Objects** removes spaces and arranges Component Objects as tightly as possible along the left, right, top or bottom edges.
- **Align Objects** straightens a group of objects along the left, right, top, or bottom edges of the group of objects. You may also align a group of objects by using Horizontal Center or Vertical Middle commands.
- **Space Evenly** equalizes the spacing in a group of objects by using Across, Down, Vertical or Horizontal commands.
- **Center in View** moves the selected object or objects to the center of the Build Window.
- **Make Same Size** will make a group of Component Objects all appear the same size. This function typically will make all objects in the group the same size as the smallest object in the selected group.

4.1.5 Connecting Component Objects

Each Component Object features connection terminals for routing audio and logic control signals between objects.

These connection terminals come in four types:

- **Audio Input Terminals** are always located on the left side of a Component Object.
- **Audio Output Terminals** are always located on the right side of a Component Object.
- **Logic Input Terminals** are always found on the top of a Component Object.
- **Logic Output Terminals** are always found on the bottom of a Component Object.

As an exception, some modules, such as a Ducker, will include an additional audio input to control the ducking process inside the module. This additional audio input will be located below the main audio input on the left side of the Component Object.

Connecting Terminals

To connect two terminals, follow these steps:

1. Click-and-hold the cursor over an Output Terminal.
2. While holding the mouse button, drag the cursor toward the desired Input Terminal on the next Component Object in the signal chain. A solid line (representing a wire) will follow the cursor out from the Output Terminal.
3. When the cursor and line approach the desired Input Terminal, the solid line will snap from the cursor to the terminal.
4. Release the mouse button to complete the connection.

Once terminals on a set of Component Objects have been connected, the connection lines will follow the objects and maintain the connections no matter where you move the Component Objects in the Build Window.

NOTE: An audio output terminal or logic output terminal can be connected to multiple Input terminals of the same type, but an input terminal of either type cannot be connected to multiple output terminals. Similarly input and output terminals on the same Component Object cannot be connected, and audio and logic terminals also cannot be connected.

5. Operation

5.1 Networking

By using Ethernet, multiple DM8000 devices can be connected on a network for system-wide programming and control.

5.1.1 Ethernet Connection

When setting up an Ethernet connection to DM8000, please keep in mind the following considerations:

- A PC computer running DM8000 DSP Designer Software with Windows® operating systems must have a 10/100 BaseT network card (NIC) installed.
- When connecting DM8000 directly to the PC's Ethernet port, you may select whether the DM8000's Ethernet port uses a "cross-over" or "straight-through" CAT5 cable to connect. (Each DM8000 ships with a straight-through CAT5 cable.)

- Ethernet switches must be 10/100 BaseT compatible, with sufficient ports for connection to each DM8000 unit (multiple switches may be used).
- Ethernet has a cable length limitation of 100 meters between the Ethernet switch and a DM8000 device. However, using fiber-optic cable can extend this length limitation to 2 km. Fiber-optic cable can be used with switches that have fiber-optic ports, or media converters can be used to interface fiber-optic cable with standard RJ-45 ports.

5.1.2 Assigning IP Addresses

When setting up an Ethernet network with multiple DM8000 units, devices in the network will need to be set up with IP addresses. Before assigning IP addresses, please keep in mind the following considerations:

The computer must be assigned an IP address (under Network Card Settings>Properties). Most computers set TCP/IP address automatically, but DM8000 devices require manual assignment. Initially, the computer IP addresses should be assigned as 192.168.1.X (where range of X = 1 to 254).

- Each DM8000 device must also be assigned a unique IP address.
- The factory default IP address for all DM8000 devices is 192.168.1.201.

5.1.3 Sending System Design

When you have completed a Signal Processing Architecture and compiled the design, you then need to send the compiled design to the DM8000 units in your network by connecting your DM8000 to your PC via Ethernet (directly or through a network).

1. Click Start Network Service either in the Design Toolbar or go to the System pulldown menu and select Network>Start Network Service. After the network service connects, the Status Bar at the bottom of the main screen should display how many devices are connected.
2. Click on the Devices Panel icon in the View Toolbar to see a list of available devices. In this window, you can review a particular device's design, set the device's name and description, and set the device's IP address.
3. Once a system design compiled and downloaded to a DM8000 device, you can control and monitor your system in real time by using the various dialog boxes to monitor and set levels.

5.2 System Security

Device Protection Enable

Device protection can be enabled by clicking **Device** → **Device Protection**

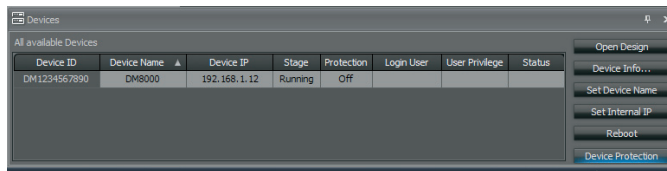

Devices Panel

One must first assign an administrator password that retains complete access to the system.

The Device Protection dialog will allow the creation of an Admin password. The password is applied by clicking the Enable Protection button.

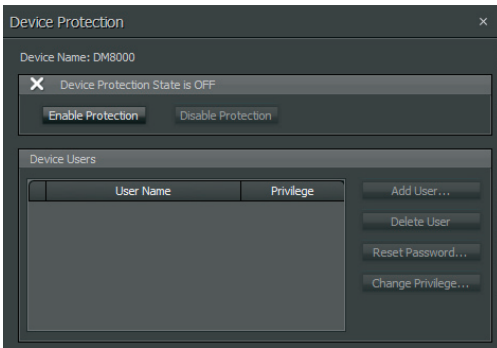

Device Protection Dialog

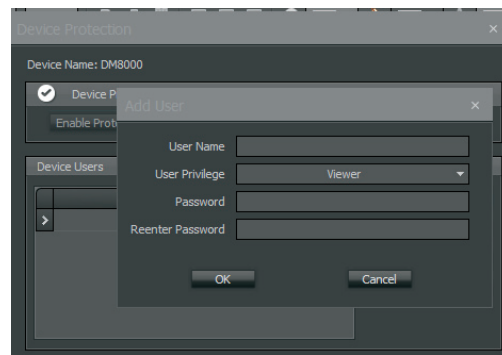

Device Protection Dialog with User Privilege Option Shown

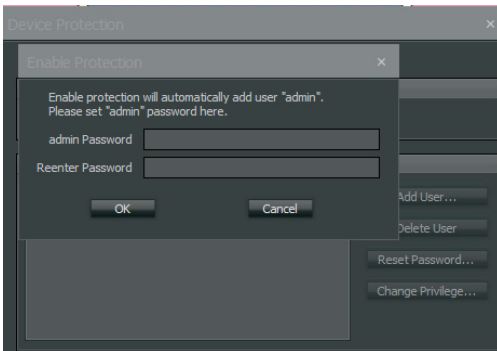

Devices Protection Dialog with Password Creation

Set the Admin Password as required.

Add/Edit User

Subsequent logins to the system at the administrator level will use the password with "admin" as the user name.

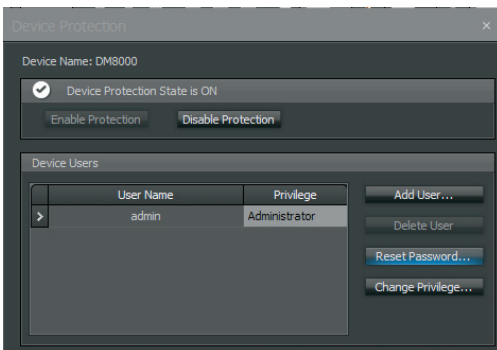

Device Protection Dialog with Admin Account under Device Users

By clicking on **Add User**, other users can be created with one of a few system access (privilege) levels:

There are three levels of access privilege:

- **Viewer** – Viewers can only read system parameters in real time, i.e., meters, mixer controls dialogs, etc.
- **Controller** – Controllers can read and write system parameters in real time, i.e., set matrix crosspoints, set levels, etc.
- **Designer** – Designers have the same privileges as above, including these additional functions:
 - Change and download the design
 - Set the Device IP address
 - Change, create and delete presets

One must be logged on as administrator to:

- Create or edit users
- Set the device name
- Reboot the device
- Update the device's firmware
- Disable protection for a protected system
- Reset password
- Change the access level for an account

Additional administrator functions:

Delete User – deletes user accounts.

Change Privilege – changes the privilege for the users.

Reset Password

To reset a password, click on **Device Protection** → **Reset Password**.

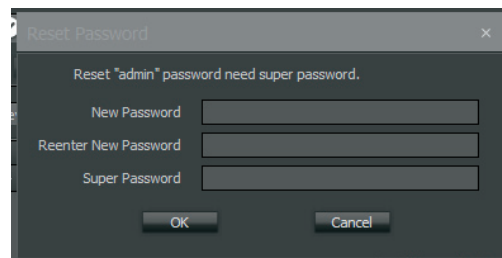

Reset Password Dialog

To reset the Admin password, you will need a "super password" to access the password reset function. Please contact your manufacturer to get the super password.

Disable Protection

To disable Device Protection, you will again need to log in as Admin and click on the **Disable Protection** button in the Device Protection dialog.

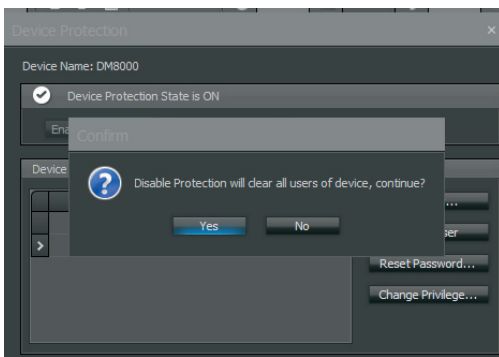

Device Protection Dialog with Disable Protection Option

To confirm that you are disabling Device Protection, click on the “Yes” button when the system asks for confirmation.

5.3 Third Party Control

DM8000 can be controlled via the RS-232 Serial Port on the rear panel of the DM8000.

For third-party control of DM8000 functions, we have created DTP (DM8000 Text Protocol). This DTP protocol simply means that DM8000 will accept strings of ASCII characters to control and read settings for Gain, Mute, Logic State, Frequency, Input Level and other parameters used by DSP Processing Modules in DM8000 products.

DTP strings can be transmitted via third-party controllers using RS-232.

A PC computer can send/receive DTP Strings by using a terminal emulator program such as HyperTerminal.

5.3.1 Activating Third Party Control

To activate DM8000’s Third Party Control mode, open your PC’s terminal emulator and input “3rdStart”. (Note that the “3rdStart” command is case sensitive.)

To exit Third Party Control mode, input “exit”.

5.3.2 System Security

To protect the system, the user must input username and password to enter Third Party Control mode. Admin can add/delete users and set/change a password by using the PC software.

Example:

```
username viewer1;
password passw1;
```

If username and password is valid, the system will set the relevant user level and enter Third Party Control mode.

5.3.3 Creating a DTP String

Valid DTP strings follow these principles of construction:

- DTP strings require a space between each parameter.
- A line feed/return or “;” needs to be placed at the end of each command string sent.
- A space is not required before a line feed/return or “;”, but is acceptable.
- DTP strings may not include an illegal character. An illegal character renders the DTP string an invalid command, and the system will not respond to the command.

- DTP strings may contain a maximum of 256 characters. If a DTP string exceeds 256 characters, the string is an invalid command.
- Sequential spaces are acceptable within the DTP string.
- Individual parameters within the DTP string may contain a maximum of 63 characters. If a parameter within a DTP string exceeds 63 characters, the string is an invalid command, and the system will not respond to the command.
- DTP strings should be structured in the following order:

Command InstanceTag AttributeTag Param1 Param2 Value;

In a DTP string, *Param1/Param2* is the DSP module channel ID. *Param1/Param2* may be required, depending on the command or attribute being referenced. If the channel ID is not required, then *Param1/Param2* should not be defined the command. *Value* may be required, depending on the command or attribute being referenced. If the command or attribute does not require it, *Value* should not be defined in the command.

Examples:

```
set Input1 Input_Gain 1 12;
get Input1 Input_Gain 1;
set Mixer Level_State 2 3 1;
```

- In a *set* command, *Value* transmits the exact setting for a parameter within a DSP module.

Example:

```
set Input1 Input_Level 1 -12
```

- In an *inc* (increment) or *dec* (decrement) command, *Value* transmits the amount by which a specific parameter should change.

Example:

```
inc Input1 Input_Gain 1 6;
```

5.3.4 RS-232 Hardware Port Considerations

The RS-232 port on the back of the DM8000 unit is set to a default baud rate of 38400, 8 data bits, no parity, 1 stop bit, and no flow control (38400:8:None:1).

5.3.5 Commands

- *get/set*
- *inc/dec*
- *toggle*
- *subscribe*
- *unsubscribe*
- *username*
- *password*
- *help* – will get all valid command keys
- *3rdStart* – starts Third Party Control mode
- *exit* – exits Third Party Control mode
- *SESSION* – send session specific Attributes and Commands
- *DEVICE* – send Device Services instructions or Device Attributes and Commands.

5.3.6 InstanceTag

All modules have one *InstanceTag* attribute, which is the module alias. User can define *InstanceTag* in the PC software. The *SESSION* command can return all valid *InstanceTag* list.

SESSION get aliases;

```
"list":["123" "AudioMeter1" "AudioMeter2" "AudioMeter3" "DEVICE"
"Input1" "Mixer1" "Mute1" "Level1" "Output1"]
```

5.3.7 Attribute

The *Attribute* defines the parameter of the DSP module to be controlled (fader level, crosspoint mute, etc).

The following tables show whether each DTP Attribute supports *set*, *get*, *inc*, *dec*, *toggle*, *subscribe*, and *unsubscribe* commands, as well as the value range that the *Attribute* will accept. *Param1/Param2* determines whether *Param1*, *Param2* or BOTH are needed for a DTP String to be complete.

DTP Strings can address the following DSP modules:

- Input/Output Modules
- USB Audio Input/USB Audio Output Modules
- DM AEC Modules
- Mixer Modules
- Equalizer Modules
- Filter Modules
- Crossover Modules
- Dynamics Modules
- Router Modules
- Delay Modules
- Control Modules
- Meter Modules
- Generator Modules
- SESSION Modules
- DEVICE Modules

5.3.8 User Example

For Device Protection State is ON:

```
3rdStart;
username viewer1;
password passw1;
set Input1 Input_Gain 1 12;
...
exit;
```

For Device Protection State is OFF:

```
3rdStart;
set Input1 Input_Gain 1 12;
...
exit;
```

5.3.9 Tables of Module Attributes

The following tables of Attributes are valid for DM8000 processing modules:

5.3.9.1 Input Output Modules

DM8000 Input 10

Description	Attribute	Commands	Param	Value Range
Input gain	<i>Input_Gain</i>	<i>set, get</i>	<i>channel</i> (value: 1 ~ 10)	0, 6, 12, 18, 24, 30, 36, 42, 48, 54, 60, 66
Phantom power	<i>Phantom_Power</i>	<i>set, get, toggle</i>	<i>channel</i> (value: 1 ~ 10)	0 = off 1 = on
Input mute	<i>Input_Mute</i>	<i>set, get, toggle</i>	<i>channel</i> (value: 1 ~ 10)	0 = unmuted 1 = muted
Input level	<i>Input_Level</i>	<i>set, get, inc, dec</i>	<i>channel</i> (value: 1 ~ 10)	-100 ~ 12 dB
Input invert	<i>Invert</i>	<i>set, get, toggle</i>	<i>channel</i> (value: 1 ~ 10)	0 = no 1 = yes
Input peak	<i>Peak</i>	<i>subscribe, unsubscribe</i>	<i>channel</i> (value: 1 ~ 10)	—

Examples:

set Input1 Input_Gain 2 18;

dec Input1 Input_Level 3 14;

Command format: *command InstanceTag Attribute channel_ID value;*

subscribe Input1 Peak 1;

Command format: *command InstanceTag Attribute channel_ID;*

NOTE: This command does not require *value*.

DM8000 Output 6

Description	Attribute	Commands	Param	Value Range
Output mute	<i>Output_Mute</i>	<i>set, get, toggle</i>	<i>channel</i> (value: 1 ~ 6)	0 = unmuted 1 = muted
Output level	<i>Output_Level</i>	<i>set, get, inc, dec</i>	<i>channel</i> (value: 1 ~ 6)	-100 ~ 0 dB
Invert	<i>Invert</i>	<i>set, get, toggle</i>	<i>channel</i> (value: 1 ~ 6)	0 = no 1 = yes
Analog output level	<i>FullScale</i>	<i>set, get</i>	<i>channel</i> (value: 1 ~ 6)	-31, 0, 6, 12, 18, 24

Examples:

set Output1 FullScale 2 -31;

dec Output1 Output_Level 3 4;

Command format: *command InstanceTag Attribute channel_ID value;*

toggle Output1 Output_Mute 1;

Command format: *command InstanceTag Attribute channel_ID;*

NOTE: This command does not require *value*.

AEC Modules

DM AEC	Attribute	Commands	Param	Value Range
AEC enabled value	<i>AEC_Enabled</i>	<i>set, get, toggle</i>	<i>channel</i> (value: 1 ~ channel_count (max: 8))	0 = AEC mode disable 1 = AEC mode enable
Noise reduction value	<i>Noise_Reduction</i>	<i>set, get</i>	<i>channel</i> (value: 1 ~ channel_count (max: 8))	0 = off 1 = low 2 = soft 3 = medium 4 = aggressive
Non-linear process mode	<i>Non_linear_process</i>	<i>set, get</i>	<i>channel</i> (value: 1 ~ channel_count (max: 8))	0 = off 1 = soft 2 = medium 3 = aggressive
Min threshold value	<i>Min_Threshold</i>	<i>set, get, inc, dec</i>	<i>channel</i> (value: 1 ~ channel_count (max: 8))	-100 ~ 0 dB
AEC ref / mic / out / REL / ERLE / TER value	<i>AEC_Status_1</i>	<i>subscribe, unsubscribe</i>	<i>channel</i> (value: 1 ~ channel_count (max: 8))	—

Examples:

set AEC1 Noise_Reduction 2 8;

Command format: *command InstanceTag Attribute channel_ID value;*

dec AEC1 Min_Threshold 3 7;

Command format: *command InstanceTag Attribute channel_ID value;*

subscribe AEC1 AEC_Status_1 1;

Command format: *command InstanceTag Attribute channel_ID;*

NOTE: This command does not require *value*.

USB Input Modules

Description	Attribute	Commands	Param	Value Range
Input mute	<i>Input_Mute</i>	<i>set, get, toggle</i>	<i>channel</i> (value: 1, 2)	0 = unmuted 1 = muted
Input level	<i>Input_Level</i>	<i>set, get, inc, dec</i>	<i>channel</i> (value: 1, 2)	-100 ~ 12 dB
Input invert	<i>Invert</i>	<i>set, get, toggle</i>	<i>channel</i> (value: 1, 2)	0 = no 1 = yes
USB input status	<i>USB_Input_Status</i>	<i>subscribe, unsubscribe</i>	—	—

Examples:

set UsbInput1 Input_Level 2 -18;

Command format: *command InstanceTag Attribute channel_ID value;*

toggle UsbInput1 Inverted 1;

Command format: *command InstanceTag Attribute channel_ID;*

NOTE: This command does not require a *value*.

subscribe UsbInput1 USB_Input_Status;

Command format: *command InstanceTag Attribute;*

NOTE: This command does not require *channel_ID* or *value*.

USB Output Modules

Description	Attribute	Commands	Param	Value Range
Output mute	<i>Output_Mute</i>	<i>set, get, toggle</i>	<i>channel</i> (value: 1, 2)	0 = unmuted 1 = muted
Output level	<i>Output_Level</i>	<i>set, get, inc, dec</i>	<i>channel</i> (value: 1, 2)	-100 ~ 0 dB
Output invert	<i>Invert</i>	<i>set, get, toggle</i>	<i>channel</i> (value: 1, 2)	0 = no 1 = yes
USB output status	<i>USB_Input_Status</i>	<i>subscribe, unsubscribe</i>	—	—

Examples:

set UsbOutput1 Output_Level 2 -31;

Command format: *command InstanceTag Attribute channel_ID value;*

get UsbOutput1 Output_Level 1;

Command format: *command InstanceTag Attribute channel_ID;*

NOTE: This command does not require *value*.

toggle UsbOutput1 Output_Mute 1;

Command format: *command InstanceTag Attribute channel_ID;*

NOTE: This command does not require *value*.

5.3.9.2 Mixers

Auto Mixer

Description	Attribute	Commands	Param	Value Range
Input mute	<i>Input_Mute</i>	<i>set, get, toggle</i>	<i>channel</i> (value: 1 ~ input_count (max: 32))	0 = unmuted 1 = muted
Input level	<i>Input_Level</i>	<i>set, get, inc, dec</i>	<i>channel</i> (value: 1 ~ input_count (max: 32))	-100 ~ 12 dB
Input level state	<i>Level_State</i>	<i>set, get, toggle</i>	<i>channel</i> (value: 1 ~ input_count (max: 32))	0 = off 1 = on
Mix output mute	<i>Mix_Output</i>	<i>set, get, toggle</i>	—	0 = unmuted 1 = muted
Mix output level	<i>Mix_Level</i>	<i>set, get, inc, dec</i>	—	-100 ~ 12 dB
Mic logic	<i>Mic_Logic</i>	<i>set, get</i>	—	0 = none 1 = last mic hold 2 = input 1
Logic outputs follow mic logic	<i>Logic_Outs_Follow</i>	<i>set, get, toggle</i>	—	0 = no 1 = yes
Open mic limits enabled	<i>OML_Enabled</i>	<i>set, get, toggle</i>	—	0 = no 1 = yes
Open mic limits open microphone number	<i>OML_Max_Open_Mics</i>	<i>set, get, inc, dec</i>	—	0 ~ channel_number-1
Channel direct output	<i>Channel_1_Direct_Output</i>	<i>set, get, toggle</i>	<i>channel</i> (value: 1 ~ input_count (max: 32))	0 = post-gate / pre-nom 1 = post-gate / post-nom
Channel manual	<i>Channel_1_Manual</i>	<i>set, get, toggle</i>	<i>channel</i> (value: 1 ~ input_count (max: 32))	0 = off 1 = on
Channel NOM gain enable	<i>Channel_1_NOM_Gain_Enable</i>	<i>set, get, toggle</i>	<i>channel</i> (value: 1 ~ input_count (max: 32))	0 = off 1 = on
Channel off attenuation	<i>Channel_1_Off_Attenuation_dB</i>	<i>set, get, inc, dec</i>	<i>channel</i> (value: 1 ~ input_count (max: 32))	-80 ~ -10
Channel gate hold time	<i>Channel_1_Gate_Hold_Time_ms</i>	<i>set, get, inc, dec</i>	<i>channel</i> (value: 1 ~ input_count (max: 32))	1 ~ 6000
Output logic	<i>Logic_1</i>	<i>set, get</i>	<i>channel</i> (value: 1 ~ logicout_count (max: 32))	0 = follow gate 1 = on 2 = off
Output invert	<i>Inverted</i>	<i>set, get, toggle</i>	<i>channel</i> (value: 1 ~ logicout_count (max: 32))	0 = no 1 = yes

Examples:

set Mixer1 Input_Mute 2 1;

Command format: *command InstanceTag Attribute channel_ID value;*

dec Mixer1 Mix_Level 11;

Command format: *command InstanceTag Attribute value;*

NOTE: This command does not require a *channel_ID*.

toggle Mixer1 NOM_Gain_Enable 3;

Command format: *command InstanceTag Attribute channel_ID;*

NOTE: This command does not require a *value*.

Standard Mixer

Description	Attribute	Commands	Param	Value Range
Input mute	<i>Input_Mute</i>	<i>set, get, toggle</i>	<i>channel</i> (value: 1 ~ input_count (max: 32))	0 = unmuted 1 = muted
Input level	<i>Input_Level</i>	<i>set, get, inc, dec</i>	<i>channel</i> (value: 1 ~ input_count (max: 32))	-100 ~ 12 dB
Output mute	<i>Output_mute</i>	<i>set, get, toggle</i>	<i>channel</i> (value: 1 ~ output_count (max: 24))	0 = unmuted 1 = muted
Output level	<i>Output_Level</i>	<i>set, get, inc, dec</i>	<i>channel</i> (value: 1 ~ output_count (max: 24))	-100 ~ 12 dB
Level state	<i>Level_State</i>	<i>set, get, toggle</i>	<i>input_ch, output_ch</i> (input_ch value: 1 ~ input_count (max: 32); output_ch value: 1 ~ output_count (max: 24))	0 = off 1 = on

Examples:

set Mixer2 Input_Mute 2 1;

Command format: *command InstanceTag Attribute channel_ID value;*

toggle Mixer2 Output_Mute 1;

Command format: *command InstanceTag Attribute channel_ID;*

NOTE: This command does not require a *value*.

set Mixer2 Level_State 2 1 3;

Command format: *command InstanceTag Attribute channel_ID1 channel_ID2 value;*

NOTE: This command requires two *Channel_ID* designations.

Matrix Mixer

Description	Attribute	Commands	Param	Value Range
Input mute	<i>Input_Mute</i>	<i>set, get, toggle</i>	<i>input_ch</i> (value: 1 ~ input_count (max: 32))	0 = unmuted 1 = muted
Input level	<i>Input_Level</i>	<i>set, get, inc, dec</i>	<i>input_ch</i> (value: 1 ~ input_count (max: 32))	-100 ~ 12 dB
Output mute	<i>Output_mute</i>	<i>set, get, toggle</i>	<i>output_ch</i> (value: 1 ~ output_count (max: 24))	0 = unmuted 1 = muted
Output level	<i>Output_Level</i>	<i>set, get, inc, dec</i>	<i>output_ch</i> (value: 1 ~ output_count (max: 24))	-100 ~ 12 dB
Level	<i>Level</i>	<i>set, get, inc, dec</i>	<i>input_ch, output_ch</i> (input_ch value: 1 ~ input_count (max: 32); output_ch value: 1 ~ output_count (max: 24))	-100 ~ 0 dB
Level state	<i>Level_State</i>	<i>set, get, toggle</i>	<i>input_ch, output_ch</i> (input_ch value: 1 ~ input_count (max: 32); output_ch value: 1 ~ output_count (max: 24))	0 = off 1 = on

NOTE: *Level_State* can support *set* commands for whole rows/columns and all cross points:

Command InstanceTag Level_State A value;

Command InstanceTag Level_State R row_line value;

Command InstanceTag Level_State C column_line value;

Mixer Matrix w/ Delay

Description	Attribute	Commands	Param	Value Range
Input mute	<i>Input_Mute</i>	<i>set, get, toggle</i>	<i>input_ch</i> (value: 1 ~ input_count (max: 32))	0 = unmuted 1 = muted
Input level	<i>Input_Level</i>	<i>set, get, inc, dec</i>	<i>input_ch</i> (value: 1 ~ input_count (max: 32))	-100 ~ 12 dB
Output mute	<i>Output_mute</i>	<i>set, get, toggle</i>	<i>output_ch</i> (value: 1 ~ output_count (max: 24))	0 = unmuted 1 = muted
Output level	<i>Output_Level</i>	<i>set, get, inc, dec</i>	<i>output_ch</i> (value: 1 ~ output_count (max: 24))	-100 ~ 12 dB
Level	<i>Level</i>	<i>set, get, inc, dec</i>	<i>input_ch, output_ch</i> (input_ch value: 1 ~ input_count (max: 32); output_ch value: 1 ~ output_count (max: 24))	-100 ~ 0 dB
Delay	<i>Delay</i>	<i>set, get, inc, dec</i>	<i>input_ch, output_ch</i> (input_ch value: 1 ~ input_count (max: 32); output_ch value: 1 ~ output_count (max: 24))	0 ~ 1000 ms
Level state	<i>Level_State</i>	<i>set, get, toggle</i>	<i>input_ch, output_ch</i> (input_ch value: 1 ~ input_count (max: 32); output_ch value: 1 ~ output_count (max: 24))	0 = off 1 = on
Delay state	<i>Delay_State</i>	<i>set, get, toggle</i>	<i>input_ch, output_ch</i> (input_ch value: 1 ~ input_count (max: 32); output_ch value: 1 ~ output_count (max: 24))	0 = off 1 = on

5.3.9.3 Equalisers

Parametric Equaliser

Description	Attribute	Commands	Param	Value Range
EQ center frequency	<i>Center_Frequency</i>	<i>set, get, inc, dec</i>	<i>band</i> (value: 1 ~ band_count (max: 16))	20 ~ 20000 Hz
EQ filter gain	<i>Filter_Gain</i>	<i>set, get, inc, dec</i>	<i>band</i> (value: 1 ~ band_count (max: 16))	-30 ~ 15 dB
EQ band width	<i>Bandwidth</i>	<i>set, get, inc, dec</i>	<i>band</i> (value: 1 ~ band_count (max: 16))	0.01 ~ 4
EQ band bypass	<i>Bypass_Band</i>	<i>set, get, toggle</i>	<i>band</i> (value: 1 ~ band_count (max: 16))	0 = no 1 = yes
EQ bypass all	<i>Bypass_All</i>	<i>set, get, toggle</i>	—	0 = no 1 = yes

Graphic Equaliser

Description	Attribute	Commands	Param	Value Range
EQ filter gain	<i>Filter_Gain</i>	<i>set, get, inc, dec</i>	<i>band</i> (1 ~ available band_count)	-30 ~ 15 dB
EQ band bypass	<i>Bypass_Band</i>	<i>set, get, toggle</i>	<i>band</i> (1 ~ available band_count)	0 = no 1 = yes
EQ bypass all	<i>Bypass_All</i>	<i>set, get, toggle</i>	—	0 = no 1 = yes

Feedback Suppressor

Description	Attribute	Commands	Param	Value Range
EF center frequency	<i>Center_Frequency</i>	<i>set, get, inc, dec</i>	<i>band</i> (value: 1 ~ band_count (max: 16))	20 ~ 20000 Hz
EF filter gain	<i>Filter_Gain</i>	<i>set, get, inc, dec</i>	<i>band</i> (value: 1 ~ band_count (max: 16))	-30 ~ 0 dB
EF bandwidth octaves	<i>Bandwidth_octaves</i>	<i>set, get, inc, dec</i>	<i>band</i> (value: 1 ~ band_count (max: 16))	0.01 ~ 4
EF fix band bypass	<i>Fix_Band</i>	<i>set, get, toggle</i>	<i>band</i> (value: 1 ~ band_count (max: 16))	0 = no 1 = yes
EF band bypass	<i>Bypass_Band</i>	<i>set, get, toggle</i>	<i>band</i> (value: 1 ~ band_count (max: 16))	0 = no 1 = yes
EF max depth	<i>Max_Depth</i>	<i>set, get, inc, dec</i>	—	-20 ~ 0
EF width	<i>Width</i>	<i>set, get, toggle</i>	—	0 = narrow 1 = wide
EF fix all band	<i>Fix_All</i>	<i>set, get, toggle</i>	—	0 = no 1 = yes
EF bypass all	<i>Bypass_All</i>	<i>set, get, toggle</i>	—	0 = no 1 = yes
EF feedback reset all	<i>Feedback_ResetAll</i>	<i>set</i>	—	0 = no 1 = yes
Feedback status	<i>Feedback_Status</i>	<i>subscribe, unsubscribe</i>	—	—

5.3.9.4 Filters

High Pass/Low Pass

Description	Attribute	Commands	Param	Value Range
Cutoff frequency	<i>Cutoff_Frequency</i>	<i>set, get, inc, dec</i>	—	20 ~ 20000 Hz
Filter type slope	<i>Filter_Type_Slope</i>	<i>set, get</i>	—	-48 dB/oct.: 0 = L-R 12 1 = L-R 24 2 = L-R 36 3 = L-R 48 4 = BW 6 5 = BW 12 6 = BW 18 7 = BW 24 8 = BW 30 9 = BW 36 10 = BW 42 11 = BW 48 -24 dB/oct.: 0 = L-R 12 1 = L-R 24 2 = BW 6 3 = BW 12 4 = BW 18 5 = BW 24
Filter bypass	<i>Bypass</i>	<i>set, get, toggle</i>	—	0 = no 1 = yes

High Shelf/Low Shelf

Description	Attribute	Commands	Param	Value Range
Cutoff frequency	<i>Cutoff_Frequency</i>	<i>set, get, inc, dec</i>	—	20 ~ 20000 Hz
Shelf filter gain	<i>Filter_Gain</i>	<i>set, get, inc, dec</i>	—	-27 ~ 9 dB
Filter bypass	<i>Bypass</i>	<i>set, get, toggle</i>	—	0 = no 1 = yes

All Pass

Description	Attribute	Commands	Param	Value Range
Center frequency	<i>Center_Frequency</i>	<i>set, get, inc, dec</i>	<i>band</i> (1 ~ <i>band_count</i> (max: 16))	20 ~ 20000 Hz
Bandwidth octaves	<i>Bandwidth_octaves</i>	<i>set, get, inc, dec</i>	<i>band</i> (1 ~ <i>band_count</i> (max: 16))	0.01 ~ 4
Band bypass	<i>Bypass_Band</i>	<i>set, get, toggle</i>	<i>band</i> (1 ~ <i>band_count</i> (max: 16))	0 = no 1 = yes
Bypass all	<i>Bypass_All</i>	<i>set, get, toggle</i>	<i>band</i> (1 ~ <i>band_count</i> (max: 16))	0 = no 1 = yes

5.3.9.5 CrossOvers

2-Way/3-Way/4-Way Modules

Description	Attribute	Commands	Param	Value Range
Input mute	<i>Input_Mute</i>	<i>set, get, toggle</i>	—	0 = unmuted 1 = muted
Input level	<i>Input_Level</i>	<i>set, get, inc, dec</i>	—	-100 ~ 12 dB
Output mute	<i>Output_mute</i>	<i>set, get, toggle</i>	<i>way_num</i> (1 ~ <i>way_count</i>)	0 = unmuted 1 = muted
Output level	<i>Output_Level</i>	<i>set, get, inc, dec</i>	<i>way_num</i> (1 ~ <i>way_count</i>)	-100 ~ 0 dB
Output polarity	<i>Output_Polarity</i>	<i>set, get, toggle</i>	<i>way_num</i> (1 ~ <i>way_count</i>)	0 = no 1 = yes
Cutoff frequency	<i>Cutoff_Frequency</i>	<i>set, get, inc, dec</i>	<i>way_num</i> (1 ~ <i>way_count</i>)	20 ~ 20000 Hz

2-Way/3-Way/4-Way Modules (Cont'd)

Description	Attribute	Commands	Param	Value Range
Filter type slope	<i>Filter_Type_Slope</i>	<i>set, get</i>	<i>way_num</i> (1 ~ <i>way_count</i>)	-48 dB/oct.: 0 = L-R 12 1 = L-R 24 2 = L-R 36 3 = L-R 48 4 = BW 6 5 = BW 12 6 = BW 18 7 = BW 24 8 = BW 30 9 = BW 36 10 = BW 42 11 = BW 48 -24 dB/oct.: 0 = L-R 12 1 = L-R 24 2 = BW 6 3 = BW 12 4 = BW 18 5 = BW 24
Synchronize	<i>Synchronize</i>	<i>set, get, toggle</i>	—	0 = no 1 = yes

5.3.9.6 Dynamics

Leveler Modules

Description	Attribute	Commands	Param	Value Range
Response time	<i>Response_Time</i>	<i>set, get, inc, dec</i>	—	0.1 ~ 40000 ms
Threshold	<i>Threshold</i>	<i>set, get, inc, dec</i>	—	-60 ~ 24 dBu
Bypass	<i>Bypass</i>	<i>set, get, toggle</i>	—	0 = no 1 = yes
Dynamic leveler status	<i>Leveler_Status</i>	<i>subscribe, unsubscribe</i>	—	—

Complimiter

Description	Attribute	Commands	Param	Value Range
Attack time	<i>Attack_Time</i>	<i>set, get, inc, dec</i>	—	0.1 ~ 2000 ms
Response time	<i>Response_Time</i>	<i>set, get, inc, dec</i>	—	0.1 ~ 40000 ms
Compress ratio	<i>Compress_Ratio</i>	<i>set, get, inc, dec</i>	—	1 ~ 100
Threshold	<i>Threshold</i>	<i>set, get, inc, dec</i>	—	-60 ~ 24 dBu
Bypass	<i>Bypass</i>	<i>set, get, toggle</i>	—	0 = no 1 = yes
Dynamic leveler status	<i>Leveler_Status</i>	<i>subscribe, unsubscribe</i>	—	—

Ducker

Description	Attribute	Commands	Param	Value Range
Input mute	<i>Input_Mute</i>	<i>set, get, toggle</i>	—	0 = unmuted 1 = muted
Input level	<i>Input_Level</i>	<i>set, get, inc, dec</i>	—	-100 ~ 12 dB
Sense mute	<i>Sense</i>	<i>set, get, toggle</i>	—	0 = unmuted 1 = muted
Sense level	<i>Sense_Level</i>	<i>set, get, inc, dec</i>	—	-100 ~ 12 dB
Threshold	<i>Threshold</i>	<i>set, get, inc, dec</i>	—	-60 ~ 24 dBu
Ducking level	<i>Ducking_Level</i>	<i>set, get, inc, dec</i>	—	-100 ~ 0 dB
Attack time	<i>Attack_Time</i>	<i>set, get, inc, dec</i>	—	0.1 ~ 2000 ms
Release time	<i>Release_Time</i>	<i>set, get, inc, dec</i>	—	0.1 ~ 40000 ms
Logic in enable	<i>Enable_Logic_In</i>	<i>set, get, toggle</i>	—	0 = no 1 = yes
Logic in invert	<i>Invert_Logic_In</i>	<i>set, get, toggle</i>	—	0 = no 1 = yes
Logic output enable	<i>Enable_Logic_Out</i>	<i>set, get, toggle</i>	—	0 = no 1 = yes

Description	Attribute	Commands	Param	Value Range
Logic output invert	<i>Invert_Logic_Out</i>	<i>set, get, toggle</i>	—	0 = off 1 = on
Mix sense	<i>Mix_Sense</i>	<i>set, get, toggle</i>	—	0 = no 1 = yes
Bypass	<i>Bypass</i>	<i>set, get, toggle</i>	—	0 = no 1 = yes

5.3.9.7 Noise Gate

Noise Gate

Description	Attribute	Commands	Param	Value Range
Attack time	<i>Attack_Time</i>	<i>set, get, inc, dec</i>	—	0.1 ~ 2000 ms
Release time	<i>Release_Time</i>	<i>set, get, inc, dec</i>	—	0.1 ~ 40000 ms
Threshold	<i>Threshold</i>	<i>set, get, inc, dec</i>	—	-60 ~ 24 dBu
Bypass	<i>Bypass</i>	<i>set, get, toggle</i>	—	0 = no 1 = yes
Noise gate status	<i>NoiseGate_Status</i>	<i>subscribe, unsubscribe</i>	—	—

5.3.9.8 ANC (Ambient Noise Compensator)

ANC Module

Description	Attribute	Commands	Param	Value Range
Dynamic program mute	<i>Program_Mute</i>	<i>set, get, toggle</i>	—	0 = unmuted 1 = muted
Dynamic program level	<i>Program_Level</i>	<i>set, get, inc, dec</i>	—	-100 ~ 12 dB
Ambient mute	<i>Ambient_Mute</i>	<i>set, get, toggle</i>	—	0 = unmuted 1 = muted
Ambient level	<i>Ambient_Level</i>	<i>set, get, inc, dec</i>	—	-100 ~ 12 dB
Ambient threshold	<i>Ambient_Threshold</i>	<i>set, get, inc, dec</i>	—	-60 ~ 24 dBu
Ambient response	<i>Ambient_Response</i>	<i>set, get, inc, dec</i>	—	500 ~ 300000 ms
Minimum gain	<i>Min_Gain</i>	<i>set, get, inc, dec</i>	—	-25 ~ 10
Maximum gain	<i>Max_Gain</i>	<i>set, get, inc, dec</i>	—	10 ~ 25
Gain ratio	<i>Gain_Ratio</i>	<i>set, get, inc, dec</i>	—	0.25 ~ 4
Time	<i>Time</i>	<i>set, get, inc, dec</i>	—	500 ~ 300000 ms
Bypass	<i>Bypass</i>	<i>set, get, toggle</i>	—	0 = no 1 = yes
ANC prog, amb, gain	<i>ANC_Status</i>	<i>subscribe, unsubscribe</i>	—	—

5.3.9.9 Routers

In/Out Routers

Description	Attribute	Commands	Param	Value Range
Router on	<i>Router_On</i>	<i>set, get, toggle</i>	<i>in, out</i> (in value: 1 ~ in_count (max: 32), out value: 1 ~ out_count (max: 32))	0 = off 1 = on

Note: *Router_On* can support *set* whole row cross point:

Command InstanceTag Router_On R row_line value;

Source Selection

Description	Attribute	Commands	Param	Value Range
Selected source ID	<i>Selected_Source</i>	<i>set, get, inc, dec</i>	—	1 ~ available source channel_count
Source level	<i>Level</i>	<i>set, get, inc, dec</i>	<i>channel</i> (1 ~ available source channel_count (max: 16))	-100 ~ 12

5.3.9.10 Delays

Delay Modules

Description	Attribute	Commands	Param	Value Range
Delay unit	<i>Units</i>	<i>set, get</i>	—	0 = milliseconds 1 = centimeters 2 = meters 3 = inches 4 = feet
Delay value	<i>Delay_value</i>	<i>set, get, inc, dec</i>	—	0 ~ max
Bypass	<i>Bypass</i>	<i>set, get, toggle</i>	—	0 = no 1 = yes

5.3.9.11 Controls

Level Control

Description	Attribute	Commands	Param	Value Range
Level mute	<i>Muted</i>	<i>set, get, toggle</i>	<i>channel</i> (1 ~ channel_count (max: 16))	0 = unmuted 1 = muted
Level value	<i>Level_dB</i>	<i>set, get, inc, dec</i>	<i>channel</i> (1 ~ channel_count (max: 16))	-100 ~ 12 dB
Maximum level value	<i>Maximum</i>	<i>set, get, inc, dec</i>	<i>channel</i> (1 ~ channel_count (max: 16))	min ~ 12 dB
Minimum level value	<i>Minimum</i>	<i>set, get, inc, dec</i>	<i>channel</i> (1 ~ channel_count (max: 16))	-100 ~ max

Level Control (Ganged)

Description	Attribute	Commands	Param	Value Range
Level mute	<i>Muted</i>	<i>set, get, toggle</i>	—	0 = unmuted 1 = muted
Level value	<i>Level_dB</i>	<i>set, get, inc, dec</i>	—	-100 ~ 12 dB
Maximum level value	<i>Maximum</i>	<i>set, get, inc, dec</i>	—	min ~ 12 dB
Minimum level value	<i>Minimum</i>	<i>set, get, inc, dec</i>	—	-100 ~ max

Level Inc/Dec

Description	Attribute	Commands	Param	Value Range
Level mute	<i>Muted</i>	<i>set, get, toggle</i>	<i>channel</i> (1 ~ channel_count (max: 16))	0 = unmuted 1 = muted
Level value	<i>Level_dB</i>	<i>set, get, inc, dec</i>	<i>channel</i> (1 ~ channel_count (max: 16))	-100 ~ 12 dB
Maximum level value	<i>Maximum</i>	<i>set, get, inc, dec</i>	<i>channel</i> (1 ~ channel_count (max: 16))	min ~ 12 dB
Minimum level value	<i>Minimum</i>	<i>set, get, inc, dec</i>	<i>channel</i> (1 ~ channel_count (max: 16))	-100 ~ max
Inc and dec level value	<i>Level_Inc_Dec</i>	<i>set, get, inc, dec</i>	<i>channel</i> (1 ~ channel_count (max: 16))	1 ~ 15
Ramp rate	<i>Ramp_Rate</i>	<i>set, get, inc, dec</i>	<i>channel</i> (1 ~ channel_count (max: 16))	100 ~ 1000
Level ramp status	<i>LevelRamp_Status</i>	<i>subscribe, unsubscribe</i>	<i>channel</i> (1 ~ channel_count (max: 16))	—

Level Inc/Dec (Ganged)

Description	Attribute	Commands	Param	Value Range
Level mute	<i>Muted</i>	<i>set, get, toggle</i>	—	0 = unmuted 1 = muted
Level value	<i>Level_dB</i>	<i>set, get, inc, dec</i>	—	-100 ~ 12 dB
Maximum level value	<i>Maximum</i>	<i>set, get, inc, dec</i>	—	min ~ 12 dB
Minimum level value	<i>Minimum</i>	<i>set, get, inc, dec</i>	—	-100 ~ max
Inc and dec level value	<i>Level_Inc_Dec</i>	<i>set, get, inc, dec</i>	—	1 ~ 15
Ramp rate	<i>Ramp_Rate</i>	<i>set, get, inc, dec</i>	—	100 ~ 1000
Level ramp status	<i>LevelRamp_Status</i>	<i>subscribe, unsubscribe</i>	—	—

Invert

Description	Attribute	Commands	Param	Value Range
Invert	<i>Invert</i>	<i>set, get, toggle</i>	<i>channel (1 ~ channel_count (max: 16))</i>	0 = no 1 = yes

Invert (Ganged)

Description	Attribute	Commands	Param	Value Range
Invert	<i>Invert</i>	<i>set, get, toggle</i>	—	0 = no 1 = yes

Mute

Description	Attribute	Commands	Param	Value Range
Mute	<i>Muted</i>	<i>set, get, toggle</i>	<i>channel (1 ~ channel_count (max: 16))</i>	0 = unmuted 1 = muted
Mute status	<i>Mute_Status</i>	<i>subscribe, unsubscribe</i>	<i>channel (1 ~ channel_count (max: 16))</i>	—

Mute (Ganged)

Description	Attribute	Commands	Param	Value Range
Mute	<i>Muted</i>	<i>set, get, toggle</i>	—	0 = unmuted 1 = muted
Mute status	<i>Mute_Status</i>	<i>subscribe, unsubscribe</i>	—	—

Logic State

Description	Attribute	Commands	Param	Value Range
State	<i>State</i>	<i>set, get, toggle</i>	<i>channel</i>	0 = off 1 = on

Logic Delays

Description	Attribute	Commands	Param	Value Range
Logic on delay value	<i>On_Delay</i>	<i>set, get, inc, dec</i>	<i>channel (1 ~ channel_count (max: 16))</i>	0 ~ 60000 ms
Logic off delay value	<i>Off_Delay</i>	<i>set, get, inc, dec</i>	<i>channel (1 ~ channel_count (max: 16))</i>	0 ~ 60000 ms
Bypass	<i>Bypass</i>	<i>set, get, toggle</i>	<i>channel (1 ~ channel_count (max: 16))</i>	0 = no 1 = yes

5.3.9.12 GPIO**GPIO Volume**

Description	Attribute	Commands	Param	Value Range
GPIO_ID	<i>GPIOID</i>	<i>get</i>	—	—
GPIO volume control module info	<i>VolumeModuleInfo</i>	<i>get</i>	—	—

Examples:

```
get Volume1 VolumeModuleInfo;
```

```
get Volume1 GPIOID;
```

GPIO Select

Description	Attribute	Commands	Param	Value Range
GPIO_ID	GPIOID	get	—	—

Examples:

get Select1 GPIOID;

GPIO Logic Output

Description	Attribute	Commands	Param	Value Range
GPIO_ID	GPIOID	get	—	—
GPIO output count	Number	get	—	—

Examples:

get LogicOutput1 GPIOID;

get LogicOutput1 Number;

GPIO WallPanel

Description	Attribute	Commands	Param	Value Range
GPIO volume ID	VolumeGPIO	get	—	—
GPIO select ID	SelectGPIO	get	—	—
GPIO control module info	WallPanelModuleInfo	get	—	—

Examples:

get WallPanel1 VolumeGPIO;

get WallPanel1 WallPanelModuleInfo;

5.3.9.13 Meters

Signal Present

Description	Attribute	Commands	Param	Value Range
Threshold	Threshold	set, get, inc, dec	channel (1 ~ channel_count (max: 16))	-64 ~ 30 dBu
Meter sig present status	SigPresent_Status	subscribe, unsubscribe	channel (1 ~ channel_count (max: 16))	—

Peak Meter

Description	Attribute	Commands	Param	Value Range
Peak hold time	Hold_Time	set, get, inc, dec	channel (1 ~ channel_count (max: 16))	0 ~ 2000 ms
Peak hold	Peak_Hold	set, get, toggle	channel (1 ~ channel_count (max: 16))	0 = no 1 = yes
Indefinite peak hold	Indefinite_Peak_Hold	set, get, toggle	channel (1 ~ channel_count (max: 16))	0 = no 1 = yes
Meter peak status	Peak_Status	subscribe, unsubscribe	channel (1 ~ channel_count (max: 16))	—

RMS Meter

Description	Attribute	Commands	Param	Value Range
RMS hold time	Hold_Time	set, get, inc, dec	channel (1 ~ channel_count (max: 16))	0 ~ 2000 ms
RMS hold	RMS_Hold	set, get, toggle	channel (1 ~ channel_count (max: 16))	0 = no 1 = yes
Indefinite RMS hold	Indefinite_RMS_Hold	set, get, toggle	channel (1 ~ channel_count (max: 16))	0 = no 1 = yes
Meter RMS status	RMS_Status	subscribe, unsubscribe	channel (1 ~ channel_count (max: 16))	—

5.3.9.14 Generators

Tone Generator

Description	Attribute	Commands	Param	Value Range
Level mute	<i>Muted</i>	<i>set, get, toggle</i>	—	0 = unmuted 1 = muted
Level value	<i>Level</i>	<i>set, get, inc, dec</i>	—	-100 ~ 36 dBu
Frequency	<i>Frequency</i>	<i>set, get, inc, dec</i>	—	20 ~ 20000 Hz
Sweep	<i>Sweep</i>	<i>set, get, toggle</i>	—	0 = no 1 = yes
Start frequency	<i>Start_Frequency</i>	<i>set, get, inc, dec</i>	—	20 ~ Stop_Frequency
Stop frequency	<i>Stop_Frequency</i>	<i>set, get, inc, dec</i>	—	Start_Frequency ~ 20000
Sweep interval	<i>Sweep_Interval</i>	<i>set, get</i>	—	0 = 1 octave 1 = 2/3 octave 2 = 1/3 octave 3 = 1/6 octave 4 = 1/12 octave 5 = narrow band
Interval time	<i>Time_Interval</i>	<i>set, get, inc, dec</i>	—	100 ~ 60000 ms

Pink Noise Generator

Description	Attribute	Commands	Param	Value Range
Pink output mute	<i>Mute</i>	<i>set, get, toggle</i>	—	0 = unmuted 1 = muted
Pink output level	<i>Level</i>	<i>set, get, inc, dec</i>	—	-100 ~ 36 dBu

White Noise Generator

Description	Attribute	Commands	Param	Value Range
White output mute	<i>Mute</i>	<i>set, get, toggle</i>	—	0 = unmuted 1 = muted
White output level	<i>Level</i>	<i>set, get, inc, dec</i>	—	-100 ~ 36 dBu

5.3.10 Other Attributes

DEVICE

Description	Service	Value
Recall a preset	<i>recallPreset</i>	Preset ID (Integer)

Note: *recallPreset* commands should take the following form:

DEVICE recallPreset presetID;

Description	Attribute Code	Command	Indexes	Value Range
Host name	<i>hostname</i>	<i>get</i>	—	—
Network interface config	<i>ipConfig</i>	<i>get</i>	—	—
Network status	<i>networkStatus</i>	<i>get</i>	—	—
Serial number	<i>serialNumber</i>	<i>get</i>	—	—
Firmware version	<i>version</i>	<i>get</i>	—	—

Example:

DEVICE get ipConfig;

*DM8000 Network Interface Config {"ip":"192.168.1.22"
"netmask":"255.255.255.0" "gateway":"0.0.0.0"}*

SESSION

Description	Attribute Code	Command	Indexes	Value Range
Aliases	<i>aliases</i>	<i>get</i>	—	—

Example:

SESSION get aliases;

*"list":[{"123" "AudioMeter1" "AudioMeter2" "AudioMeter3" "DEVICE"
"Input1" "Mixer1" "Mute1" "Level1" "Output1"}]*

6. Index

- 2**
2-Way Crossover, 6, 22
- 3**
3-Way Crossover, 6, 22
- 4**
4-Way Crossover, 6, 22
- A**
Acoustic Echo Cancellation (AEC), 13, 15
Active Band (parameter), 19, 20, 22,
AEC (modules), 15, 39,
AEC (Acoustic Echo Cancellation), 13, 15
AEC 1 (modules), 15
AEC Advanced Dialog Box, 15
AEC N (modules), 15
AEC Ref 8 Channel, 15
AEC, Typical Design, 15
AEC, Typical System, 15
Align Objects, 8, 11, 37
All-Pass Filter (module), 6, 20-21
Amb Meter (parameter), 25, 38
Ambient Label (parameter), 25
Ambient Level (parameter), 25, 38, 43
Ambient Mute (parameter), 25, 43
Ambient Noise Compensator (ANC) (module), 6, 22, 24,
Ambient Response (parameter), 25, 38, 43
Ambient Threshold (parameter), 25, 38, 43
ANC (Ambient Noise Compensator) (module), 6, 22, 24, 38, 43
ANC (Automatic Noise Cancellation), 25, 38
ANC Setup Procedure, 25, 38
AND Gate (modules), 31
Arranging Component Objects in the Build Window, 37
Assign Matrix, 18
Assigning IP Addresses Procedure, 39
Attack Time (parameter), 23, 24, 42,
Audio Input Terminals, 37, 38
Audio Output Terminals, 37, 38
Auto Mixers (modules), 16-17
Automatic Noise Cancellation (ANC), 25, 38
Automatic Noise Cancellation (ANC) Setup Procedure, 38
Automatic Noise Cancellation (ANC) Setup Procedure, Making Connections, 28
Automatic Noise Cancellation (ANC) Setup Procedure, Setting Gain Min and Gain Max, 38
Automatic Noise Cancellation (ANC) Setup Procedure, Setting Response Times, 38
- B**
Background Color, 7
Band (parameter), 19, 22, 41
Bandwidth (parameter), 19, 20, 22, 41
Basic Screen Elements, 4
Bold (text format), 7
Border Color, 7
Build Toolbar, 8, 11
Build Toolbar Elements, 8
Build Window, 4-10, 13, 15, 16, 19, 20, 22, 26-30, 36-38
Bypass (parameter), 15, 20-26, 32, 41-44
Bypass All (parameter), 19, 20, 22, 41
Bypass Band (parameter), 19, 20, 41
- C**
Center (parameter), 7, 8, 11, 37
Center Freq. (parameter), 19, 20, 22,
Center in View, 8, 11, 37
Channel Settings, 17
Close (file command), 9, 11
Close All (file command), 9, 11
Compile, 8-10, 12-13
Compile Output Panel, 9-10, 12, 13
CompLimiter (module), 6, 22, 23, 42
Component Objects (explained), 13
Connecting Component Objects Procedure, 37
Connecting Terminals Procedure, 38
Content (command), 9, 11
Control Dialog (command), 10
Control Inputs (parameter), 30,
Controls (modules), 6, 26
Copy (command), 9, 10
Copy DSP Data (command), 10
CrossOvers (modules), 6, 22
 2-Way, 22
 3-Way, 22
 4-Way, 22
Cut (command), 9-10
Cutoff Freq. (parameter), 20-21
Cutoff Frequency (parameter), 22

- D**
- Delay Value (parameter), 26
 - Delays (modules), 6, 26
 - Delay Value (parameter), 26
 - Units, 26, 43
 - Delete (command), 9, 10
 - Deploying Component Objects Procedure, 36
 - Deploying Component Objects Procedure, Drag-and-Drop Method, 36
 - Deploying Component Objects Procedure, Module Library Toolbar Method, 37
 - Deploying Component Objects Procedure, Pulldown Menu Method, 37
 - Designated Mic On (parameter), 17
 - Device Info, 12
 - Device Information Display, 12
 - Device Panel, 9-10, 12
 - Direct Output (parameter), 17, 40
 - DM8000 Input 10 Channel, 13-14
 - DM8000 Output 6 Channel, 13-14, 38
 - Download Design to Device (command), 8, 10
 - Drag Points (parameter), 19-20, 22
 - DSP, 13-15, 20, 30, 32
 - DSP Operation Toolbar, 8
 - Ducker (modules), 6, 22-24, 37
 - Ducking Level (parameter), 24, 42
 - Duplicate (command), 10
 - Dynamics (modules), 6, 22
 - ANC (Ambient Noise Compensator), 24-25, 38, 43
 - Complimiter, 6, 22, 24, 42
 - Ducker, 6, 22-24, 37, 42
 - Leveler, 6, 22-23, 42
 - Noise Gate, 6, 22, 24, 42
- E**
- Edit Mode, 8
 - Edit Pulldown Menu, 10
 - Edit Text (command), 10, 16
 - Enable Logic (parameter), 26, 42
 - Enable Ramping (parameter), 28-29
 - Rate (parameter), 28-29, 44
 - Enter Editing Mode (command), 8, 10
 - Ethernet, 4, 12, 38-39
 - Ethernet Connection, 38
 - Ethernet switch, 38
 - Ethernet, Cable Length, 38
 - Exit (command), 9
- F**
- Feedback Suppressor (modules), 20, 41
 - Fiber-optic cable, 38
 - File Pulldown Menu, 9
 - Filter (modules), 6, 20-22
 - All-Pass, 6, 20-22
 - High Pass, 6, 20-21
 - High Shelf, 6, 21
 - Low Pass, 6, 20-21
 - Low Shelf, 6, 21-22
 - Filter Slope (parameter), 20
 - Filter/Slope (parameter), 21-22
 - Firmware Upgrade Manager, 10, 12
 - Fix All (parameter), 20, 41
 - Fix Band (parameter), 20, 41
 - Flatten All (parameter), 19
 - Flatten Band (parameter), 19
 - Flip Flop (parameter), 31, 44
 - Flip Flop Gate (modules), 31
 - Font, 7
 - Font Size, 7
 - ForeColor, 7
 - Format Toolbar, 7
 - Frequency (parameter), 22, 35, 41-42, 45
 - Full Scale (parameter), 14, 19-20
- G**
- Gain (parameter), 14, 19-21
 - Gain Max (parameter), 25, 38
 - Gain Meter (parameter), 25
 - Gain Min (parameter), 25, 38
 - Gain Ratio (parameter), 25, 43
 - Gain Time (parameter), 25, 38
 - Gang Controls (parameter), 27-30
 - Ganged Controls, 27-30
 - Gate Hold Time (parameter), 17, 40
 - Generators (modules), 6, 35-36
 - GPIO (General Purpose In Out), 30, 32-33
 - GPIO (modules), 32-33
 - GPIO Logic Output (modules), 32-33
 - GPIO Logic Output, GPIO Mapping (parameter), 33
 - GPIO Logic Output, Outputs Count (parameter), 33
 - GPIO Mapping (parameter), 33
 - GPIO Mode (parameter), 33

GPIO Number (parameter), 33
 GPIO Port (hardware panel), 32-33
 GPIO Select (modules), 32-33
 GPIO Volume (modules), 32
 GPIO Mode (parameter), 33
 GPIO Number (parameter), 33

Gradient (color), 7
 Graphic Equaliser (modules), 19
 Grid On (command), 8, 11

H

Hardware, Minimum, 4
 Help Pulldown Menu, 11
 HIGH (Logic state), 31, 35
 High Pass (modules), 6, 20
 High Shelf (modules), 6, 20-21
 Hold Time (parameter), 17, 34, 40, 44-45

I

ID (parameter), 18
 In (parameter), 25
 In/Out Routers (modules), 25
 Inc/Dec (parameter), 28
 Indefinite Hold (parameter), 34, 40, 45
 Input Level (parameter), 22, 24, 39-41
 Installation Procedure, 4
 Invert (modules), 29
 Invert (parameter), 14, 17, 29, 39, 42, 44
 IP addresses, 39
 Italic (text command), 7

L

Label (parameter), 27, 29-30
 Last Mic Hold (parameter), 17
 Layout Pulldown Menu, 11, 37
 Left Justify (text command), 7
 Level (parameter), 14, 26, 33, 35-36, 39-45
 Level Control (modules), 26-28
 Maximum (parameter), 27-28, 43-44
 Minimum (parameter), 27-28, 43-44
 Level In (parameter), 16, 18
 Level Inc/Dec (modules), 28-29
 Enable Ramping (parameter), 28-29
 Level Out (parameter), 16, 18-19
 Leveler (modules), 6, 22-23, 42

Logic Delays (modules), 31-32, 44
 Logic Delay, Off (parameter), 32
 Logic Delay, On (parameter), 32
 Logic Gates (modules), 30-31
 AND Gate, 31
 Flip Flop Gate, 31
 GPIO, 30
 HIGH (Logic state), 31
 Logic State, 31, 44
 LOW (Logic state), 31
 NAND Gate, 31
 NOR Gate, 31
 NOT Gate, 31
 OR Gate, 31
 XOR Gate, 31
 Logic In (parameter), 24, 42
 Logic Input Terminals, 37
 Logic Meter (modules), 6, 33-35, 37
 Logic Out (parameter), 24, 42
 Logic Output (parameter), 17
 Logic Output Terminals, 37
 Logic Outputs (parameter), 17
 Logic Outputs Follow Mic Logic (parameter), 17
 Logic State (modules), 31, 34
 LOW (Logic State), 31
 Low Pass (modules), 6, 20-21
 Low Shelf (modules), 6, 21

M

Main Menus, 9-11
 Main Screen, 4-5
 Make Same Size (command), 8, 11, 37
 Manual (parameter), 17
 Matrix Mixer (modules), 18
 Matrix w/Delay (modules), 18-19
 Maximum (parameter), 27-28, 43-44
 Meter (parameter), 24
 Meter Label (parameter), 24, 33-35
 Meters (modules), 6, 33-35
 Logic Meter, 6, 33
 Peak Meter, 6, 33-34
 RMS Meter, 6, 34
 Signal Present, 6, 33

Mic Options (parameter), 17

Minimum (parameter), 27-28, 43-44

Mix Sense (parameter), 24, 42

Mixers (modules), 6, 16-19, 39-40

Auto Mixer, 16-18

Matrix Mixers, 18

Matrix Mixers w/Delay, 18-19

Standard Mixer, 17-18

Modifying Modules in the Build Window Procedure, 37

Module Library, 13-35

Module Library Panel 6-10

Module Library Toolbar 6-7, 11, 13, 16-17, 19

Modules, 6, 7, 11, 13-36

Controls, 6, 26-27

Crossovers, 6, 22

Delays, 6, 26

Dynamics, 6, 22-24

Equalisers, 6, 19-20

Filters, 6, 20-22

Generators, 6, 35-36

Input Output, 6, 7, 13-14

Meters, 6, 33-35

Mixers, 6, 16-19

Routers, 6, 25-26

Modules Pulldown Menu, 11

N

NAND Gate (modules), 31

Network, 8-10, 12, 39

Network card, 4, 38

Network Panel, 9, 10, 12

Network Toolbar, 8

Networking, 38

Networking, Ethernet Connection, 38

New (file command), 9

Noise Gate (modules), 6, 22, 24, 42

NOM Gain, 17, 40

NOR Gate (modules), 31

NOT Gate (modules), 31

Non-Linear Processing, 15

O

Open (file command), 9

Open Mic Limits, 17

Operating Systems, Recommended, 4

Options, 10

OR Gate (modules), 31

Order, 8, 11, 37

Output Range, 22

Outputs Count, 33

Overview Panel, 10

Overview Screen, 5

P

Pack Objects, 8, 11, 37

Parametric Equaliser (modules), 19

Paste, 9, 10

Paste DSP Data, 10

Peak (parameter), 14

Peak Meter (modules), 33, 34

Phantom Power (parameter), 14

Pink Noise Generator (modules), 35, 36

Preset Buttons (modules), 32

Preset ID (parameter), 32

Buttons, Preset Name (parameter), 32

Recall, 32

Preset ID, 32

Preset Manager, 11

Preset Name, 32

Preset Pulldown Menu, 11

Print, 9

Print Preview, 9

Processing Modules, 6, 7, 11, 13-36

Prog Meter (parameter), 25

Program Label (parameter), 25

Program Level (parameter), 25, 43

Program Mute (parameter), 25, 43

Properties Panel, 9, 10

Properties Screen, 5

Pulldown Menus, 9-11

R

Ratio (parameter), 23, 42, 43
 Reboot, 12
 Recall (parameter), 32
 Recent Files, 9
 Release Time (parameter), 23, 24, 42
 Reset All, 20
 Response Time (parameter), 23, 42
 RestoreDefaultLayout, 10
 Right Justify, 7
 RMS Meter (modules), 34
 Hold Time (parameter), 34, 44
 Indefinite Hold (parameter), 34
 Label (parameter), 34
 Routers (modules), 6, 25
 In/Out, 25
 Source Selection, 6, 26
 RS232, 39
 RS232, 3rd-Party Command Attribute Table, 39-45
 Ruler Bar, 8, 11

S

Save, 9
 Save As, 9
 Select All (command), 9, 10
 Sending System Design Procedure, 39
 Sense Level (parameter), 24, 42
 Set All (parameter), 17
 Set Device Name, 12
 Set Internal IP, 12
 Setting Gain Min and Gain Max Procedure, 38
 Signal Present (modules), 6, 33
 Signal Present Meter (modules), 33
 Meter Label (parameter), 23, 33, 34, 35
 Threshold (parameter), 33
 Snap to Grid, 8, 11
 Software Interface Overview, 4
 Source (parameters), 26
 Source Channel Count (parameter), 26
 Source Selection (modules), 6, 26
 Enable Logic (parameter), 26, 42
 Source Channel Count (parameter), 26

Space Evenly (command), 8, 11, 37
 Standard Mixer (modules), 17, 18
 Standard Toolbar, 9
 Start Frequency (parameter), 35, 45
 Start Network Service, 8, 10, 39
 Status Bar, 12, 39
 Stop Frequency (parameter), 35, 45
 Stop Network Service, 8, 10
 Sweep (parameter), 35, 45
 Sweep Interval (parameter), 35, 45
 Sync (parameter), 22
 System Pulldown Menu, 10
 System Requirements, 4

T

Text (modules), 16
 Text Color, 7
 Third Party Control, 39
 Threshold (parameter), 23-25, 33, 42, 44
 Time Interval (parameter), 35, 45
 Tone (parameter), 35
 Tone Generator (modules), 35
 Start Frequency (parameter), 35, 45
 Stop Frequency (parameter), 35, 45
 Sweep (parameter), 35, 45
 Sweep Interval (parameter), 35, 45
 Time Interval (parameter), 35, 45
 Tone (parameter), 35

U

UltraNet In (module), 15
 UltraNet Out, 13, 14, 38
 Underline, 7
 Units (parameter), 26, 43
 USB Input (modules), 16
 USB Out (modules), 16, 38

V

View Pulldown Menu, 10, 12
 View Toolbar, 9, 12, 39

W

White Noise Generator (modules), 36
 Window Pulldown Menu, 11
 Windows (Operating System), 4

X

XOR Gate (modules), 31

Z

Zoom, 8, 11

Zoom 1:1, 8, 11

Zoom In, 8, 11

Zoom Out, 8, 11

Zoom to Fit, 8, 11

Zoom to Scale, 8

FEDERAL COMMUNICATIONS COMMISSION COMPLIANCE INFORMATION



Responsible Party Name: **MUSIC Group Research
UK Limited**

Address: **Klark Industrial Park,
Walter Nash Road,
Kidderminster. Worcestershire.
DY11 7HJ. England.**

Phone Number: **+44 1562 741515**

DM8000

complies with the FCC rules as mentioned in the following paragraph:

This equipment has been tested and found to comply with the limits for a Class A digital device, pursuant to Part 15 of the FCC Rules. These limits are designed to provide reasonable protection against harmful interference when the equipment is operated in a commercial environment. This equipment generates, uses, and can radiate radio frequency energy and, if not installed and used in accordance with the instruction manual, may cause harmful interference to radio communications. Operation of this equipment in a residential area is likely to cause harmful interference in which case the user will be required to correct the interference at his own expense.

Important information:

Changes or modifications to the equipment not expressly approved by MUSIC Group can void the user's authority to use the equipment.

