



ACT-828 Wideband Dual-Channel Digital Receiver
ACT-818 Wideband Single-Channel Digital Receiver

User Guide

MIPRO MIPRO Electronics Co., Ltd.

Headquarters: 814 Pei-Kang Road, Chiayi, 60096, Taiwan.

Web: www.mipro.com.tw

E-mail: mipro@mipro.com.tw

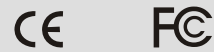

! IMPORTANT SAFETY INSTRUCTIONS !

1. Read these instructions.
2. Keep these instructions.
3. Heed all warnings.
4. Follow all instructions.
5. Do not use this apparatus near water.
6. Clean only with a dry cloth.
7. Do not block any ventilation openings. Install in accordance with the manufacturer's instructions.
8. Do not install near any heat sources such as radiators, heat registers, stoves, or other apparatus (including amplifiers) that produce heat.
9. Do not defeat the safety purpose of the polarised or ground plug: A polarised plug has two blades with one wider than the other. The wide blade is provided for your safety. When the provided plug does not fit into your outlet, consult an electrician for replacement of the obsolete outlet.
10. Protect the power cord from being walked on or pinched particularly at plug, convenience receptacles, and the point where they exit from the apparatus.
11. Only use attachments/accessories specified by the manufacturer.
12. Use only with a cart, stand, tripod, bracket, or table specified by the manufacturer, or sold with the apparatus. When a cart is used, use caution when moving the cart/apparatus combination to avoid injury from tip-over.
13. Unplug this apparatus during lightning storms or when unused for long periods of time.
14. Refer all servicing to qualified service personnel. Servicing is required when the apparatus has been damaged in any way, such as power-supply cord or plug is damaged, liquid has been spilled or objects have fallen into the apparatus, the apparatus has been exposed to rain or moisture, does not operate normally, or has been dropped.
15. To reduce the risk of fire or electric shock, do not expose this apparatus to rain or moisture.
16. Apparatus should not be exposed to dripping or splashing and no objects filled with liquids, should be placed on the apparatus.
17. Use only with the battery which specified by manufacturer.
18. The power supply cord set is to be the main disconnected device.



WARNING

1. FOR OUTDOOR USE:

To reduce the risk of fire or electric shock, do not expose this apparatus to rain or moisture.

2. UNDER WET LOCATION:

Apparatus should not be exposed to dripping or splashing and no objects filled with liquids, such as vases should be placed on the apparatus.

3. SERVICE INSTRUCTIONS:

CAUTION - These servicing instructions are for use by qualified service personnel only. To reduce the risk of electric shock, do not perform any servicing other than that contained in the operating instructions unless you are qualified to do so.



 This symbol indicates that dangerous voltage constituting a risk of electric shock is present within this unit.

 This symbol indicates that there are important operating and maintenance instructions in the literature accompanying this unit.

IC-ID

This device complies with RSS-310 of Industry Canada. Operation is subject to the condition that this device does not cause harmful interference.

FCC

THIS DEVICE COMPLIES WITH PART 15 OF THE FCC RULES OPERATION IS SUBJECT TO THE FOLLOWING TWO CONDITIONS:

(1) This device may not cause interference.

(2) This device must accept any interference, including interference that may cause undesired operation of the device. This equipment complies with FCC RF radiation exposure limits set forth for an uncontrolled environment.

Disposal

Dispose of any unusable devices or batteries responsibly and in accordance with any applicable regulations.

Disposing of used batteries with domestic waste is to be avoided!

Batteries / NiCad cells often contain heavy metals such as cadmium(Cd), mercury(Hg) and lead(Pb) that makes them unsuitable for disposal with domestic waste. You may return spent batteries/ accumulators free of charge to recycling centres or anywhere else batteries/accumulators are sold.

By doing so, you contribute to the conservation of our environment!



2005-08-13

Contents

- 1 Product Overview
- 3 Key Features
- 4 Receiver Controls and Indicators - Front Panel
- 5 Receiver Controls and Indicators - Rear Panel
- 7 Receiver Installation
- 9 Rackmount Installation for Receivers
- 10 Receiver Operating Tips
- 11 Receiver VFD Interface
- 12 Function Selection
- 22 MIPRO'S Proprietary "ACT" Function and Operation
- 25 Computer Network Interface Operation
- 26 General Tips for Improving System Performance
- 27 Troubleshooting

Product Overview

MIPRO's industry-leading digital wireless microphone system features compander-free technology ensures crystal-clear, natural vocal reproduction. The handheld transmitter microphone is equipped with a premium true condenser microphone capsule and provides warm and accurate transient detail. Expanded 64MHz bandwidth ensures optimal flexibility and interference-free, compatible channels can be operated simultaneously.

Accessories

The following accessories are included:

Antenna x 2

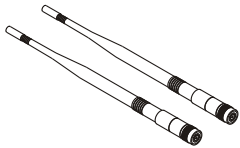

User Guide x 1

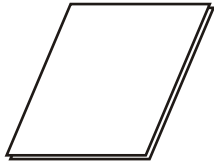

Power Cable x 1

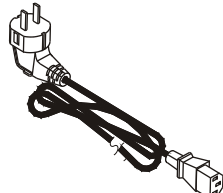

Phone Cable x 1

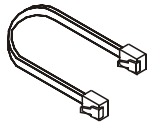
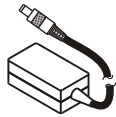
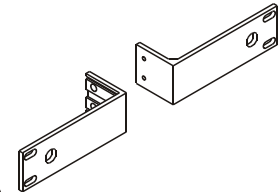
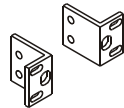
Power Supply x1
(ACT-818)Rack-mount kit x 1 set
(ACT-818)Rack-mount kit x 1 set
(ACT-828)

Key Features

- ACT-828 is an EIA standard 1U dual channel and ACT-818 is a 1/2U single channel rack-mountable receiver with metal chassis.
- Full-color VFD (vacuum fluorescent display) for clear viewing all parameters. All controls are intuitive and easily accessible, allowing for quick and easy system setup via a single rotary control.
- Enhanced RF circuitry improves anti-interference characteristics and system compatibility.
- 64MHz wide bandwidth allows more interference-free channels can be selected.
- New digital diversity receiving technology eliminates signal dropouts and enhances receiving range.
- Digitally-processed RF circuitry and DigitnamicPlus™ technology eliminates compander noise assuring the wireless sound quality almost as good as cable transmission.
- Second generation DSP technology enhances signal stability and reduces the risk of signal dropouts during interferences.
- Improved < 2.7 ms latency. Proprietary Audio A/D Converter provides a true dynamic range of 115 dBA, T.H.D. < 0.03% at 1 kHz.
- Without the pre-emphasis and de-emphasis circuit used by analog systems, the sound quality at high frequency remains clear and detailed.
- SPDIF Digital Audio Interface facilitates a direct connection to digital mixing consoles and transmits signal without distortion, therefore S/N ratio will not deteriorate in long distance transmission.
- Proprietary 256-bit encryption guarantees secure audio transmission, preventing unauthorized listening.
- Built-in 10 SmartEQ™ preset and user-defined microphone capsule equalization for faithful reproduction to suit artists' preferences.
- Built-in 10 digital anti-feedback SmartEQ™ minimize howling feedback effectively without sacrificing sound quality.
- Ideal audio signal transmissions for studio, stage and music instruments, achieving "CD quality" performance.
- Energy-saving design improves power efficiency and decreases temperature rise.
- Optional MIPRO RCS2.Net software allows real-time network remote-controlling and monitoring of 64 systems.

Receiver Controls and Indicators

Front Panel

ACT-818

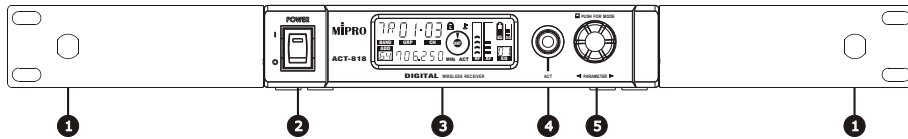

ACT-828

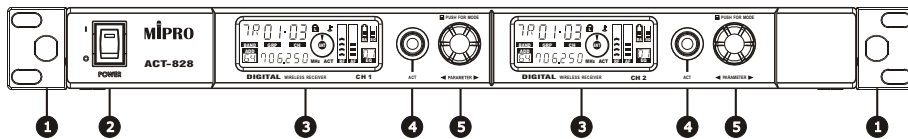

- ❶ **Front Antenna A/B Input Connector Access:** Allows fitting of an optional FBC-71 rear-to-front antenna kit to enable front antenna placement.
- ❷ **Power Switch and Indicator:** Powers the receiver on or off. When switch is turned on, the red indicator illuminates and VFD panel will light up.
- ❸ **Receiver Display Screen:** Color VFD (Vacuum Fluorescent Display).
- ❹ **ACT Button & IR Port:** Press and release ACT button syncs the transmitter and receiver frequency automatically.
- ❺ **Rotary Knob:** Selects and sets the parameters.

Receiver Controls and Indicators

Rear Panel

ACT-818

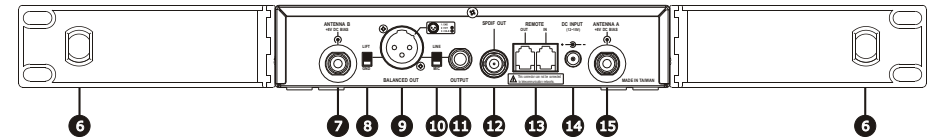

ACT-828

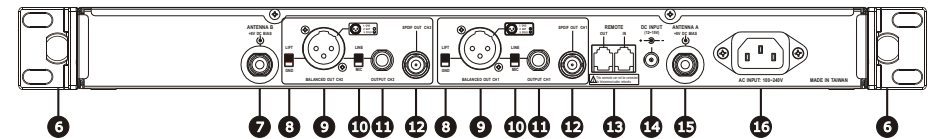

- ❷ **Rack-Mount Brackets:** Fits into a standard 19-inch rack case.
Optional MIPRO FBC-71 rear-to-front cables can be installed for front antenna placement to improve reception quality.
- ❷ **Rear Antenna B Input Connector:** The B antenna installs directly to this connector and also provides power to an optional antenna booster (AT-70B) or active antenna (AT-90W/AT-70W).
- ❸ **Lift/GND switch (CH2/CH1):**
GND: Pin 1 of XLR connector is grounded;
LIFT: Pin 1 of XLR connector is not grounded. (GND = default value).
- ❹ **Balanced Audio Output Socket (CH2/CH1):** 3 pin XLR type connector provides balanced audio output signal same as microphone sensitivity level.
- ❺ **Mic/Line Switch (CH2/CH1):** Controls analog balanced output & unbalanced output level.
MIC level is microphone output level (0dB);
LINE level is auxiliary output.
- ❻ **Unbalanced Audio Output Jack (CH2/CH1):** 6.3mm (1/4") phone-jack type connector provides unbalanced audio output signal.
- ❼ **Digital Output (CH2/CH1):** SPDIF Digital Output

Wideband Digital Receivers

- 13 **Network Interface Connector:** Mipro proprietary comms bus to link receiver(s) to the optional computer system-monitoring program. (Requires MIPRO Serial or USB adapter included with software package)
- 14 **DC Input Jack:** Accepts +12V DC (center pin is positive and sleeve is ground).
- 15 **Rear Antenna A Input Connector:** The A antenna installs directly to this connector and also provides power to an optional antenna booster (AT-70B) or active antenna (AT-90W/AT-70W).
- 16 **AC Mains Power Socket:** 100 ~ 240V AC.

Wideband Digital Receivers

Receiver Installation

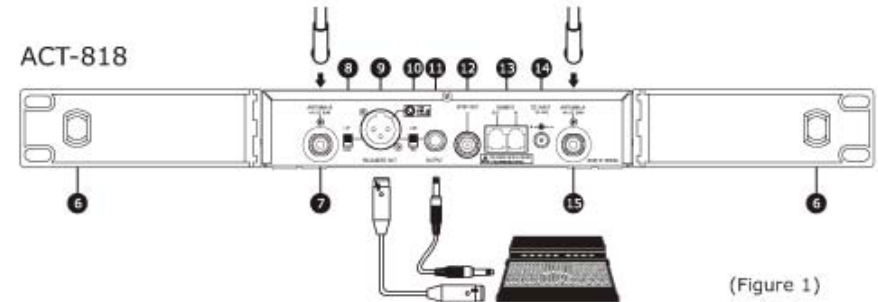

(Figure 1)

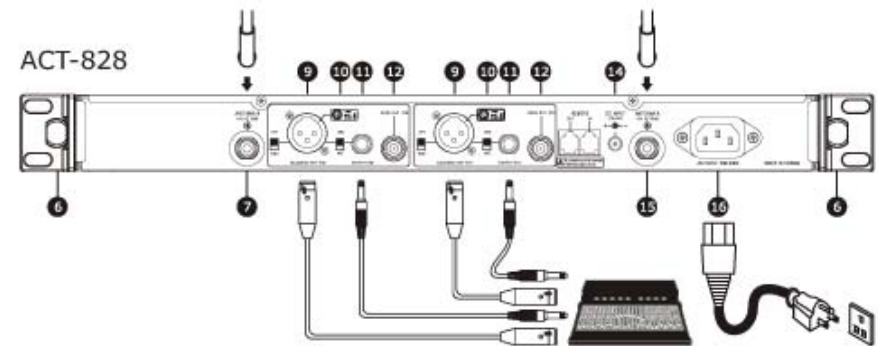

(Figure 2)

Antenna Installation:

- Install 2 separate antennas on the antenna sockets 7 15 on the rear panel. illustrated in (Figure 1/Figure 2).

Connecting the power supply:

- **AC Power Operation:** Connect the AC power cable to the AC Input Jack 16, then plug the other end into an AC outlet having the correct voltage and rating, (See Figure 2)(ACT-828)
- **DC Power Operation:** Connect the output end of AC/DC power supply to DC 12V Input Jack 14, then plug the power supply unit into an appropriate AC outlet as shown in (Figure 3). (**Caution:** Be sure the power supply is connected to an AC outlet with the correct voltage and rating.)

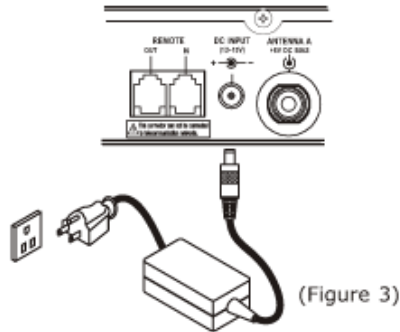

(Figure 3)



(Figure 4)

Audio Output Connection:

Level Switch Setting Position for Unbalanced Output:

- When connecting from receiver's unbalanced output to the "LINE-IN" jack of a mixer or amplifier or "Electric Guitar", switch the Level Switch to "LINE" position. Low sensitivity may occur if switch to the wrong level position. When connecting from receiver's unbalanced output to the "MIC IN" jack of a mixer or amplifier; switch the Level Switch to "MIC" position. Louder or quieter volume of microphone may occur if switch to the wrong level position. When using electric guitar, don't use "MIC" position as it may have generated insufficient level.

Connection Method of Unbalanced Output:

- When receiver and mixer/amplifier is under short distance. Or the connectors of receiver/mixer/amplifier are "PHONE" types. Using audio output cable attached with "PHONE PLUG" type, connect one end from the unbalanced output jack, of the receiver, and the other end to the "LINE-IN" input jack of the mixer/amplifier, as shown in (Figure 1/Figure 2).
- **Balanced Output Switch:** 2 levels of output gain are available: **LINE** or **MIC**. Select the most appropriate output level to interface with your mixer or amplifier. If distortion is experienced, adjust the level control to a lower setting until the desired output is attained.
- **Balanced Output:** Using audio output cables with 3 pin "XLR" type connectors, connect one end to the balanced output socket of the receiver, and the other end to the "MIC IN" input of the mixer or amplifier, as shown in (Figure 1/Figure 2). (The configuration of the 3-pin connector is as shown in (Figure 4))
- **Electric Guitar Output:** Using an XLR to 1/4" Jack type connector cable (use Pins 1 and 2 only) connect to guitar input socket on amplifier. Make sure that the gain level is set at 0dB on both receiver and transmitter.

Rackmount Installation for Receivers

Half-Rack Unit Receiver

- Install the optional FB-71 rackmount kit & fasten with screws on both sides. (Figure 5)

1-Rack Unit Receiver

- Install the optional FB-72 rackmount kit & fasten with screws on both sides. (Figure 6)

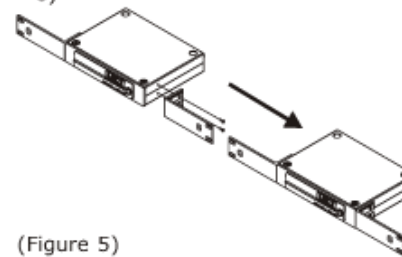

(Figure 5)

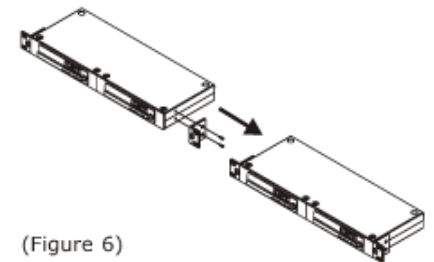

(Figure 6)

Receiver Rack-Mount Kits

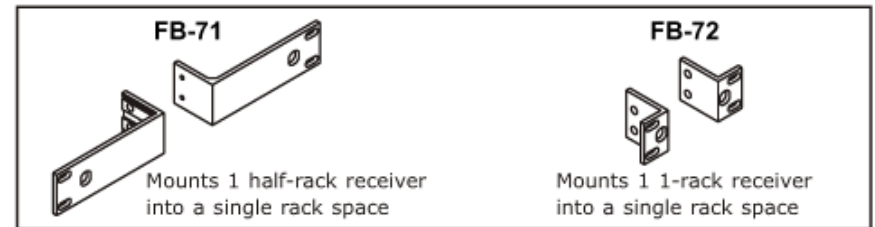

- The rack mountable kits are pre-drilled with 4 opening holes to be fitted on an EIA standard 19-inch rack case. (Figure 7)
- For ideal reception and performance, install the receiver at least 1 meter (3 feet) above the ground and away from EMI / RFI "noise" sources. In addition, place the transmitter/microphone at least 1 meter (3 feet) away from the receiving antenna, as shown. (Figure 8)

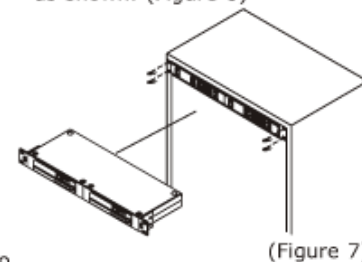

(Figure 7)

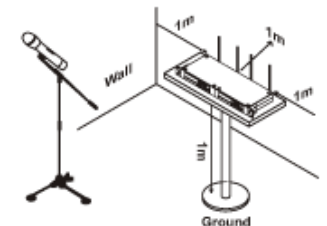

(Figure 8)

Receiver Operating Tips

- Prior to powering on the receiver, ensure all transmitters are turned off and the mixer's volume control is set to minimum.
- Normally, the RF meter level illuminates fully when a transmitter is powered on to indicate the receiver is ready for operation. Once an audio signal is received from the transmitter, the AF (audio) meter level will also illuminate based on signal level. If the meter or indicator does not indicate or there is no audio output, the system may not be set up properly. Re-check that the transmitter has fresh batteries and is turned on and the receiver and transmitter are on the same frequency. If not, the transmitter will need to be set up via the ACT sync function.
- The microphone output level in normal use should be adjusted at the amplifier or mixer. There is no need to adjust output levels at the receiver itself once initial setup is completed.
- The antenna inputs provide an 8-volt DC bias and are designed to work with MIPRO antenna boosters and active antennas. If the connecting cable is longer than 10 metres (approx. 30'), it is advisable to install an antenna booster to ensure optimum reception.
- Antenna dividers and receivers must match the same frequency band (i.e. both should be marked 6B, 6C etc.)

Receiver VFD Interface

All information displays on the same VFD screen.

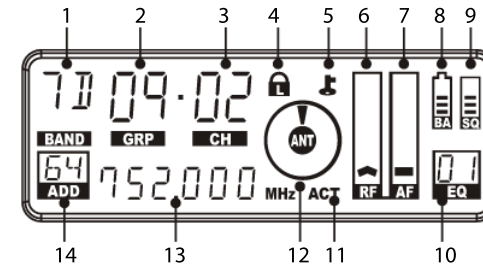

- 1 Frequency Band (Indication only)
- 2 Group (Can be programmed)
- 3 Channel (Can be programmed)
- 4 Parameter Lock Icon (Can be turned on or off)
- 5 Encryption Status Icon (Can be turned on or off)
- 6 RF Signal Meter (Indicates received signal strength)
- 7 Audio Signal Meter (Indicates audio input level from transmitter)
- 8 Transmitter Battery Meter (Shows real-time battery status)
- 9 Squelch Meter (Settings can be programmed)
- 10 Equaliser (Can be programmed)
- 11 ACT Indicator
- 12 Diversity A/B Antenna Signal Indicators (For antenna setup only)
- 13 Working Frequency (MHz.)
- 14 Address Code (For remote control ID. Can be programmed)

Fully-Lit VFD Screen

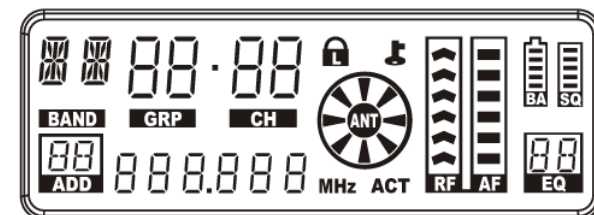

Function Selection

Rotary Controller: To set parameter values

8 parameters can be selected and programmed. See instructions below:

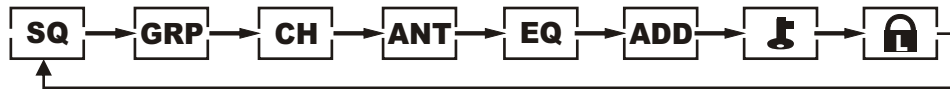

Parameter Setting Procedures

To Activate Parameters

Press the rotary controller knob ⑤ to activate and move the cursor to any of the 8 parameters. Each press moves the cursor to the next parameter. The selected parameter cursor begins to flash when activated. Rotate the rotary controller whilst flashing to change a parameter value.

To Change Parameters

Rotate the rotary controller knob clockwise to increase or counterclockwise to decrease the parameter values.

To Save Changed Parameters Manually

The parameter changes will be saved manually if the rotary controller is pressed after adjusting. The cursor stops flashing after the rotary controller is pressed to confirm the change.

To Save Changed Parameters Automatically

The parameter changes will be saved automatically if the rotary controller is not pressed for approximately 5 seconds. The cursor also stops flashing after 5 seconds.

SQ: Squelch Setting

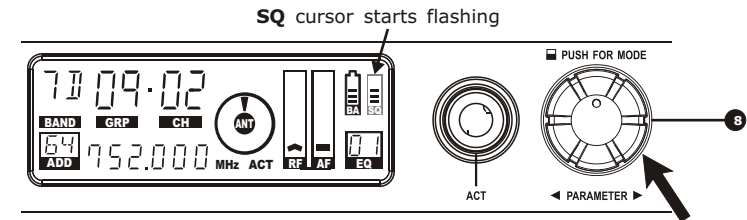

Rotate **clockwise** to increase the setting by one bar
Rotate **counterclockwise** to decrease by one bar

Operating Procedure:

1. Press the rotary controller ⑤ to activate and move the cursor to the **SQ** parameter. When the **SQ** cursor starts to flash, the squelch level is ready to be set.
2. Rotate the rotary controller clockwise to increase the **SQ** level; counterclockwise to decrease the level.
3. Press the rotary controller once to confirm and save the selected **SQ** level or wait 5 seconds (without touching anything) and the parameter will automatically be saved.

NOTE: The higher the level indicators, the lower the sensitivity - which shortens the transmission range. The lower the level indicators, the higher the sensitivity which increases the transmission range. However, when the **SQ** is set at full level (5 bars), the "**AutoScan**" function will be disabled and users can freely select any group or channel manually.

GRP: Group Setting

Refer to the supplied channel plan for your band to select a specific frequency.

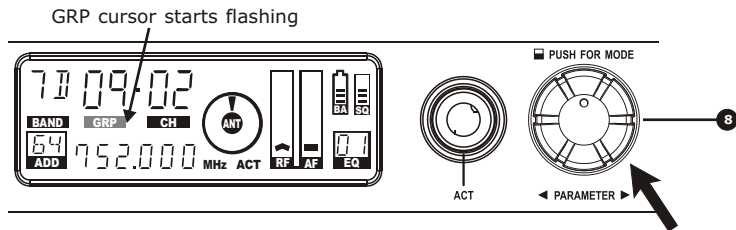

Turn **clockwise** to increase by one group
 Turn **counterclockwise** to decrease by one group

Operating Procedure:

1. Press the rotary controller  to activate and move the cursor to the **GRP** parameter. When the **GRP** cursor starts to flash, the Group is ready to be set.
2. Rotate the rotary controller clockwise to increase the Group number; counterclockwise to decrease the Group number.
3. Press the rotary controller once to confirm and save the selected Group number (or wait for autosave).

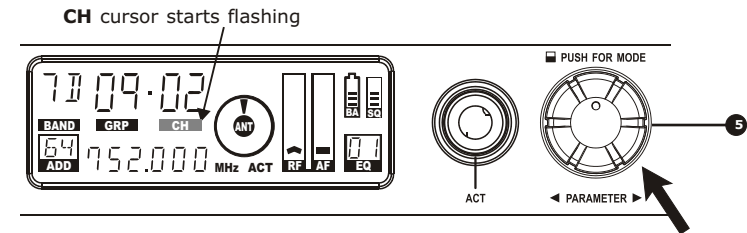
CH: Channel Setting

Rotate the controller to AutoScan for an open, interference-free preset channel

Operating Procedure:

1. Press the rotary controller  to activate and move the cursor to the **CH** parameter. When the **CH** cursor starts to flash, the Channel is ready to be set.
2. Rotate the rotary controller clockwise to increase the Channel number; counterclockwise to decrease the Channel number.
3. Press the rotary controller once to confirm and save the selected Channel number (or wait for autosave).

NOTE: When the **SQ** is set at full level (showing 5 bars), the "**AutoScan**" function will be disabled and the user may freely select any preset group or channel manually.

ANT: Antenna A/B Setting

Used for setup only.

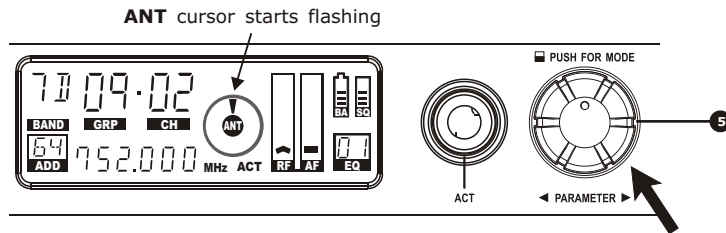

Operating Procedure:

Antenna "Auto" Setting

This is used primarily to test each remote antenna position for signal strength when setting the system up in a venue. The Antenna selection is factory set by default to the "Auto" setting. MIPRO recommends that the antenna is always left set to "Auto" in normal use.



1. Press the rotary controller ⑤ to activate and move the cursor to the ANT parameter. When the outer ANT cursor starts to flash, the antenna indicator is ready to be set.
2. Press and hold the rotary controller for 3 seconds until the inner ANT cursor starts to blink.
3. Rotate the rotary controller to the "Auto" position.
4. Press the rotary controller once to confirm and save the selected antenna position (or wait for auto save)

Antenna "A" or "B" Setting:

Important: Antenna A or B setting is only to be used for testing received signal strength during the sound check. Repeated signal dropouts may occur if the receiver is set to just "A" or "B" only. Thus, this setting is not recommended for performance. Once antenna testing is complete, change back to "Auto" and store the setting.

1. Press the rotary controller ⑤ to activate and move the cursor to ANT parameter. When the outer ANT cursor starts to flash, the Antenna is ready to be set.
2. Press and hold the rotary controller for 3 seconds until the inner ANT cursor starts to blink.
3. Rotate the rotary controller to either antenna "A" or "B".
4. Press and release the rotary controller to set the selected antenna position.

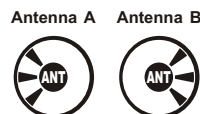

EQ: Capsule Equaliser Setting

The **EQ** parameter is used to select from a range of simulated microphone capsule EQ's. The default setting for the factory fitted MIPRO capsule is "00"

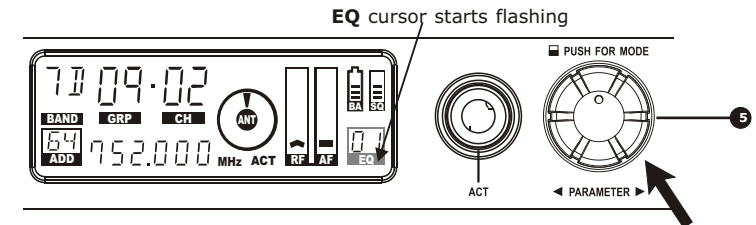

Turn **clockwise** to increase by one number
Turn **counterclockwise** to decrease by one number

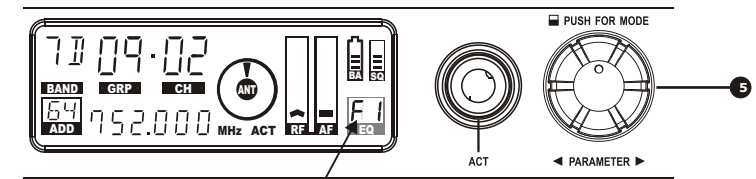

"F" denotes anti-feedback feature is activated
"0" denotes anti-feedback feature is not activated

Operating Procedure:

1. Press the rotary controller ⑤ to activate and move the cursor to the **EQ** parameter. When the **EQ** cursor starts to flash, the Equalizer is ready to be set.
2. Rotate the rotary controller clockwise to increase the Equalizer number; counterclockwise to decrease the Equalizer number.
3. The first digit in **EQ** parameter will be either F or 0. F denotes anti-feedback is activated and 0 denotes anti-feedback is not activated.
4. The second digit in **EQ** parameter denotes the selected Equalizer number. A total of 10 **EQ** numbers are available starting with 0 and ends with 9. Numbers 0 ~ 8 are preset **EQs** and number 9 is user-defined. 0 is the default **EQ** number.

NOTE: There are 9 preset and 1 user-defined built-in equalisers (00-09). **EQ** "00" is the default **EQ** for the factory fitted MIPRO handheld microphone capsule. EQ's "01-08" are eight other simulated microphone capsule presets. **EQ** "09" is user-defined and can be programmed by the user. However, the receiver needs to be set up and interfaced with a PC and MIPRO software before this can be achieved.

ADD: Address Setting for PC Remote Control

For normal "stand-alone" use, this parameter does not need to be set. However when multiple receivers are to be used and controlled remotely using the MIPRO optional control software each receiver must be given a unique address. Always ensure that you set this address before adding the receiver to the remote control network.

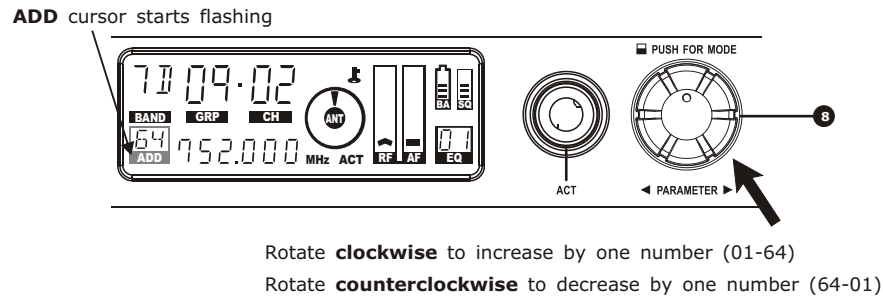

Operating Procedure:

1. Press the rotary controller ⑤ to activate and move the cursor to the **ADD** parameter. When the **ADD** cursor starts to flash, the Address is ready to be set.
2. Rotate the rotary controller clockwise to increase the Address number; counterclockwise to decrease the Address number.
3. Press the rotary controller once to confirm and save the selected Address number.

NOTE: This receiver is equipped with an ACT-BUS interface. It allows users to use the MIPRO-DV (interface converter) and software (sold separately with MIPRO-DV) for remote PC monitoring. It can monitor up to a maximum of 64 channels at the same time. The receiver module address can be set from 1 to 64. In order to monitor the system remotely, each channel must have its own address for individual identification. If two or more channels have been assigned the same address, it will cause confusion in the monitoring system. If the system is not under PC monitoring/control, identical addresses will not affect the receivers' operation.

Encryption (🔒): to Add or Remove Encryption

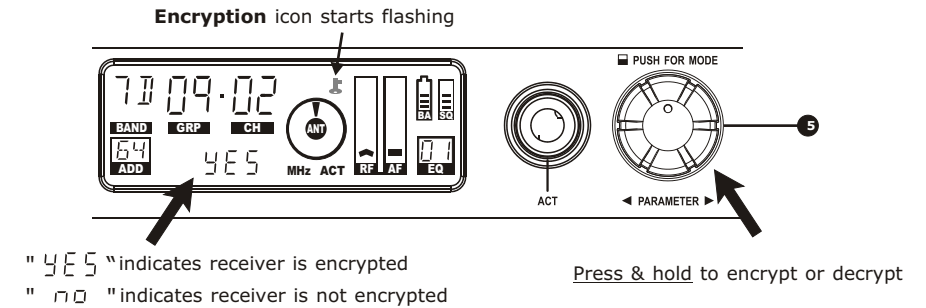



Encryption Instructions:

1. Press the rotary controller ⑤ to activate and move the cursor to the 🔒 icon. When the 🔒 icon starts to flash and the word "NO" appears, the encryption function is ready to be set.
2. Press and hold the rotary controller for approximately 3 seconds until the word changes from "NO" to "YES".
3. Press rotary controller once to confirm and save the selected "YES" for encryption. The transmitter now needs to be synced to the receiver using the ACT function to apply the encryption.

NOTE:

- Encryption is factory set by default to "NO" in the receiver (encryption OFF).
- The transmitter can only display encryption status and cannot activate/de-activate encryption.
- The 128-bit encryption key is randomly generated; hence, a new, secure, encryption key is also downloaded to a transmitter each time an ACT function is synced successfully.
- This means the last encrypted transmitter will work only with the encrypting receiver. It also means that previously encrypted transmitters will not work with the encrypting receiver even though they are on the same frequency as there will be no audio output. This method also ensures that another similar receiver cannot listen in to the encrypted transmitter.

Decryption Instructions:

1. Press the rotary controller  to activate and move the cursor to the  icon. When the  icon starts to flash and the word "YES" appears, the Encryption function is ready to be set.
2. Press and hold the rotary controller for approximately 3 seconds until the word changes from "YES" to "NO".
3. Press the rotary controller once to confirm and save the selected "NO" to turn off the Encryption. Transmitter now needs to be re-synced using ACT to turn transmitter encryption OFF.

Encryption Setup Flow Chart

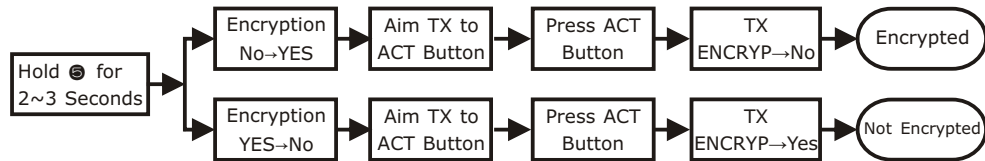

(Encrypted)

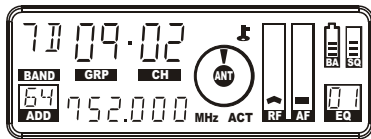

(Not Encrypted)



Parameter Lock (): to Lock and Unlock Receiver Parameters

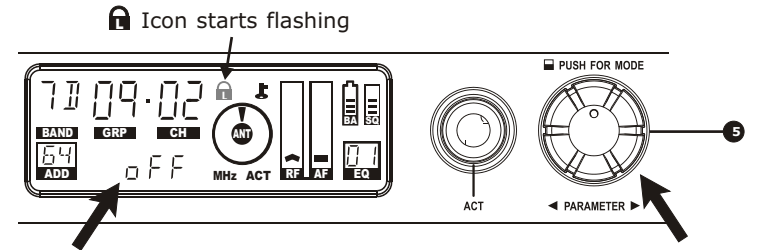



"  " Indicates the receiver is ready to be locked

"  F F " Indicates the receiver is not locked



Rotate for "ON" or "OFF"

To Lock Receiver:

1. Press the rotary controller  to activate and move the cursor to the  icon. When the  icon starts to flash, the Lock function is ready to be set.
2. Rotate the rotary controller clockwise or counterclockwise to the "ON" position.
3. Press the rotary controller once to confirm and save the selected "ON" to lock all parameters.

NOTE: When locked, the receiver parameters can no longer be changed (except this one!). However, you can still navigate to view existing settings and parameters.

To Unlock Receiver:

1. Press the rotary controller  to activate and move the cursor to the  icon. When the  icon starts to flash, the Lock function is ready to be set.
2. Rotate the rotary controller clockwise or counterclockwise to the "OFF" position.
3. Press the rotary controller once to confirm and save the selected "OFF" to unlock all parameters. Changes can now be made normally.

( : icon illuminated: Parameters locked) (no  : icon: Receiver not locked)

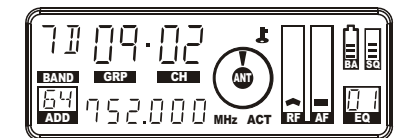

MIPRO'S Proprietary "ACT" Function and Operation

What is ACT?

"ACT" stands for "Automatic Channel Targeting". MIPRO developed and patented this innovative InfraRed (IR) technology in 2001. MIPRO was the first manufacturer in the industry to automatically synchronise the frequency selected on the receiver to any ACT handheld or bodypack transmitter in the same frequency band.

ACT Benefits

- No manual frequency adjusting needed, unlike traditional transmitters.
- Simple, fast and precise frequency setup without mechanical errors.
- Once the frequency has been set, the data is written to memory in the transmitter. This ensures that the transmitter frequency now stays with that transmitter. That is, of course, until a change is required. By performing the "ACT" function again, the frequency can be re-programmed to another Group/Channel as necessary.

ACT Set-Up

- Ensure a receiver channel is set up, the transmitter battery is charged, and the transmitter is powered ON.
- Press and release the **ACT** button on the receiver to activate the **ACT** sync function. Once activated, the words "ACT" and "Sync" will illuminate.
- Move the **ACT** handheld or bodypack transmitter IR window to within 30cm (12") of the IR port on the receiver. The IR port on the receiver is located behind the "ACT" button itself and is indicated by a round, dark red dot. The frequency will sync automatically.
- When the frequencies have successfully synchronised between the receiver and transmitter the illuminated "ACT" and "Sync" will disappear. The RF meter will now illuminate and show full RF strength.

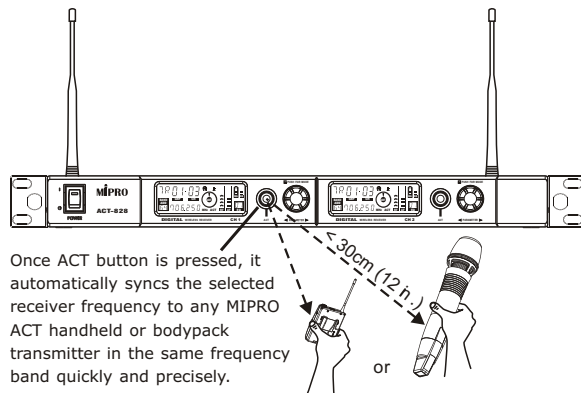

Setting ACT Transmitter Frequency

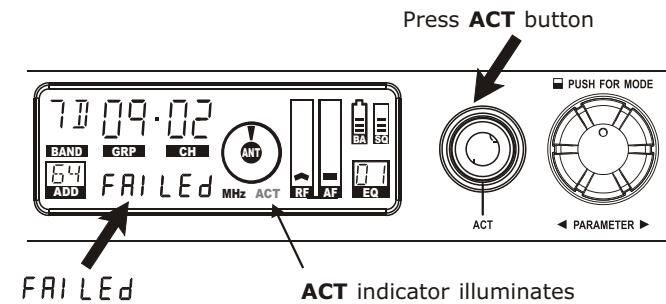

Indicates the frequencies did not sync successfully. Ensure the IR windows in both the receiver and transmitter are lined up and can "see" each other, then press the **ACT** button again.

To Activate:

Press the "ACT" button once to activate the **ACT** sync function. Once activated, the words "ACT" and "Sync" on the receiver will illuminate. Flashing will stop when the IR signal is received by the handheld or bodypack transmitter or no IR signal is received within 10 seconds.

To Cancel:

- When the words "ACT" and "Sync" on the receiver illuminate, press the ACT button again.
- When the words "ACT" and "Sync" on the receiver illuminate, do not press any button. **ACT** function will stop and cancel automatically after about 10 seconds.

Instructions:

1. Ensure a receiver channel is set up (Group / Channel), the transmitter battery is charged and the transmitter is powered ON.
2. Press the **ACT** button on the receiver to activate the **ACT** function. Once activated, the words ACT and Sync will illuminate.
3. Bring the ACT handheld or bodypack transmitter within 30cm (12") of the IR port on the receiver (check your transmitter documentation to find out where the IR port is located on the transmitter). The receiver IR port is located behind the "ACT" button and indicated by a round dark red dot. The transmitter/receiver frequency will sync automatically.
4. When the frequencies are successfully synchronised the words ACT and Sync will disappear and the RF meter will immediately indicate full RF signal received.

NOTE: If encryption is turned on, the ACT function will also send a new encryption key to the transmitter and lock it. To unlock the transmitter it is necessary to re-sync the transmitter again using ACT with the receiver in "Encryption OFF" mode.

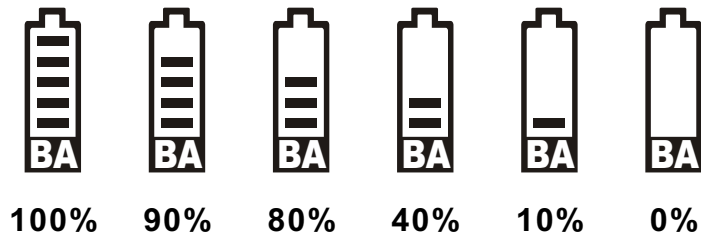
BA: Transmitter Battery Meter (receiver display)

The battery meter illuminates when the transmitter is powered ON. The LCD battery meter gives a percentage (%) indication of remaining battery life, as shown above. Recharge the transmitter battery (or replace with a charged battery pack) immediately when battery indicators fall to 10% (1 bar showing as indicated above).

Computer Network Interface Operation

1. MIPRO ACT receivers are fitted with an ACT-BUS interface to enable remote control and monitoring via a PC-based control system. To enable this to communicate, an optional MIPRO interface adapter and software package is required.
2. **Wiring Instructions**
 - Network interfacing of the ACT-818/ACT-828 receivers is achieved via the REMOTE IN of the Network Interface Connector ⑬. This enables the receiver(s) to be linked to a computer using a MIPRO-DVJ (Serial) or MIPRO-DVU (USB) interface connector. Using the RS-232 or USB connector, you can link to a computer through the RS-232 COM port or USB port. (See diagram below)

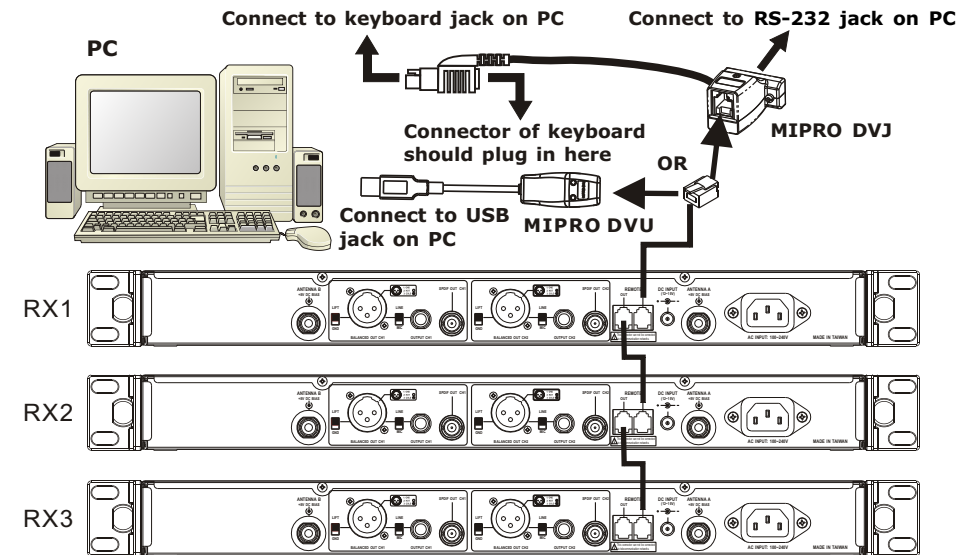

- Plug one side of the supplied telephone-type cable (RJ-11 connectors) to the REMOTE OUT socket of the on the rear of the receiver and the other end of the cable to the REMOTE IN socket on the rear of the second receiver. Repeat this connection for each receiver in the system as per the illustration above. Finally, connect the REMOTE IN socket on the rear of the first receiver to the MIPRO-DVU or MIPRO-DVJ.
- The system can link, monitor and control up to 64 receiver channels simultaneously.
- The connection cable to the computer can be up to 300 metres (330 yards) in length. However, signal stability and data transmission speed decreases as cable distance gets longer. RF it is recommended not to exceed 100m (110 yards) to maintain the highest data quality as well as a high transmission speed.

General Tips for Improving System Performance

- Since the installation of the antenna influences the operating efficiency of the receiver, the most important rule is to minimise the distance as much as possible between the receiving antenna and the microphone for the best reception and performance.
- Use MIPRO supplied antennas to ensure proper receiver sensitivity.
- A built-in worldwide approved switching power supply assures stable performance in the range of 100-240V AC mains power input.
- The antenna socket provides an 8V DC biased output. RF, shorting the antenna socket should be avoided. Temporary shorts on the antenna socket will not affect system performance (provided the short is removed), however, a continuous short on the socket may cause permanent system damage.
- If extended reception distance is required, installing a MIPRO wideband active directional antenna kit (AT-90W) will increase antenna performance and thus achieve better range.
- Proper antenna distribution is vital to achieving ideal performance from multiple wireless systems operating in the same environment. To greatly reduce antenna clutter in multi-system installations, a MIPRO AD-707a UHF wideband antenna divider system is recommended. Each AD-707a supports up to four UHF diversity receivers to operate from a single pair of antennas. When combined with an AT-70A omni-directional extension antenna and an AT-70B antenna booster or an AT-90W wideband active directional antenna, the AD-707a antenna divider provides optimal signal reception with minimal dropouts or interference. Note that the AD-707a antenna divider must match the same band designation (7A,7B,8A,8B etc.) as the receiver to ensure proper operation.
- MIPRO's factory preset "interference-free" channels within the same channel group are recommended to ensure optimum performance from multiple wireless systems installed in the same venue. Use of preset "interference-free" channels from different channel groups may cause interference due to intermodulation issues, and is therefore not recommended.

Troubleshooting

Symptom	Solutions
No Sound	<ul style="list-style-type: none"> • Power-on receiver & transmitter. • Receiver is plugged into a power outlet and cable connected to mixer/amplifier. • Fresh batteries in transmitter and inserted with correct polarity. • Match receiver & transmitter frequency.
Signal Drop-outs	<ul style="list-style-type: none"> • Close proximity between the transmitter and receiver antenna. • Line-of-sight path between the transmitter and receiver antenna. • Reposition the receiver and/or receiver antennas. • Receiver antennas are connected. • Elevate receiver antennas as high as possible. • Keep hands off of the transmitter antenna.
Limited Range	<ul style="list-style-type: none"> • Close proximity between the transmitter and receiver antenna. • Adjust antenna orientation. • Reposition the receiver and/or receiver antennas. • Receiver antennas are connected. • Undamaged antennas. • Fresh batteries in transmitter. • Adjust for proper squelch level setting.
No RF Signal	<ul style="list-style-type: none"> • Match receiver & transmitter frequency. • Adjust for proper squelch level setting.
Distortion	<ul style="list-style-type: none"> • Reduce transmitter gain, if set too high. • Recommendation: set to 0dB (Mic Level). • Reduce receiver output setting. • Proper setting on mixer input gain or integrated amplifier mic level control. • Fresh batteries in transmitter.

Troubleshooting

Symptom	Solutions
RF Interference	<ul style="list-style-type: none"> • Press AutoScan button to locate a clear, interference-free channel. • Use preset compatible channels in the same group when operating multiple systems. • Place receivers away or remove the sources of RF interference like solid metal objects, electronic equipment & digital devices, dimmers, effect equipment, motors. • Avoid operating a frequency on a local TV channel. • A higher squelch setting improves protection against interference. (however, resulting in limited range) • Turn off one transmitter, if both transmitters are operating on the same frequency. • Fresh batteries in transmitter.
Feedback	<ul style="list-style-type: none"> • Turn down the sound system volume. • Move microphone closer to the performer's mouth. • Reduce transmitter gain if set too high. • Position microphone further away from the speakers. Do not point towards speakers. • Use right type of microphone for the specific applications. Uni/Omni, Supercardioid / Cardioid. • Power off all unused microphones.