

ALLEN&HEATH

AHM 64

Getting Started Guide

AHM-64

ⓘ Before starting please check www.allen-heath.com for the latest firmware and documentation.

Limited One Year Manufacturer's Warranty

Allen & Heath warrants the Allen & Heath -branded hardware product and accessories contained in the original packaging ("**Allen & Heath Product**") against defects in materials and workmanship when used in accordance with Allen & Heath's user manuals, technical specifications and other Allen & Heath product published guidelines for a period of ONE (1) YEAR from the date of original purchase by the end-user purchaser ("**Warranty Period**").

This warranty does not apply to any non-Allen & Heath branded hardware products or any software, even if packaged or sold with Allen & Heath hardware.

Please refer to the licensing agreement accompanying the software for details of your rights with respect to the use of software/firmware ("EULA").

Details of the EULA, warranty policy and other useful information can be found on the Allen & Heath website: www.allen-heath.com/legal.

Repair or replacement under the terms of the warranty does not provide right to extension or renewal of the warranty period. Repair or direct replacement of the product under the terms of this warranty may be fulfilled with functionally equivalent service exchange units.

This warranty is not transferable. This warranty will be the purchaser's sole and exclusive remedy and neither Allen & Heath nor its approved service centres shall be liable for any incidental or consequential damages or breach of any express or implied warranty of this product.

Conditions Of Warranty

The equipment has not been subject to misuse either intended or accidental, neglect, or alteration other than as described in the User Guide or Service Manual, or approved by Allen & Heath. The warranty does not cover fader wear and tear.

Any necessary adjustment, alteration or repair has been carried out by an authorised Allen & Heath distributor or agent.

The defective unit is to be returned carriage prepaid to the place of purchase, an authorised Allen & Heath distributor or agent with proof of purchase. Please discuss this with the distributor or the agent before shipping. Units returned should be packed in the original carton to avoid transit damage.

DISCLAIMER: Allen & Heath shall not be liable for the loss of any saved/stored data in products that are either repaired or replaced.

Check with your Allen & Heath distributor or agent for any additional warranty information which may apply. If further assistance is required please contact Allen & Heath Ltd.

AHM-64 Getting Started Guide Issue 3

Copyright © 2020 Allen & Heath. All rights reserved.

ALLEN & HEATH

Allen & Heath Limited, Kernick Industrial Estate, Penryn, Cornwall, TR10 9LU, UK

<http://www.allen-heath.com>

IMPORTANT - Read before starting

Safety instructions

Before starting, read the **Important Safety Instructions** printed on the sheet supplied with the equipment. For your own safety and that of the operator, technical crew and performers, follow all instructions and heed all warnings printed on the sheet and on the equipment panels.

System operating firmware

The function of AHM-64 is determined by the firmware (operating software) that runs it. Firmware is updated regularly as new features are added and improvements made.

① Check www.allen-heath.com for the latest version of firmware.

Software licence agreement

By using this Allen & Heath product and the software within it you agree to be bound by the terms of the relevant **End User Licence Agreement** (EULA), a copy of which can be found at www.allen-heath.com/legal. You agree to be bound by the terms of the EULA by installing, copying, or using the software.

Further information

Please refer to the **Allen & Heath website** for further information, knowledgebase and technical support. For more information on AHM-64 setup and functions please refer to the AHM-64 System Manager Help.

① Check for the latest version of this Getting Started Guide.

General precautions

- Protect the equipment from damage through liquid or dust contamination.
- If the equipment has been stored in sub-zero temperatures allow time for it to reach normal operating temperature before use at the venue.
- Avoid using the equipment in extreme heat and direct sunlight. Make sure the ventilation slots are not obstructed and that there is adequate air movement around the equipment.
- Clean the equipment with a soft brush and dry lint-free cloth. Do not use chemicals, abrasives or solvents.
- It is recommended that servicing is carried out only by an authorised Allen & Heath agent. Contact details for your local distributor can be found on the Allen & Heath website. Allen & Heath do not accept liability for damage caused by maintenance, repair or modification by unauthorised personnel.

Register your product

Register your product online at www.allen-heath.com/register.

Packed items

Check you have received the following:

- AHM-64 matrix processor
- This Getting Started Guide
- Safety Sheet
- IEC mains lead
- Phoenix connectors with strain relief (1x 10-pin, 24x 3-pin, 1x 2-pin)

Contents

IMPORTANT - Read before starting	3
Packed items	4
Contents	4
1. Introduction.....	5
1.1 AHM-64 features	5
2. Installing AHM-64.....	6
2.1 Free standing	6
2.2 Rack mounting.....	6
2.3 Rear rack kit.....	6
3. Front Panel	7
4. Rear Panel	8
5. Top Panel	10
6. Connections - audio	11
6.1 Audio expanders over SLink	11
6.2 SLink connection to SQ, dLive, Avantis or other AHM-64	13
6.3 Dante expanders.....	13
7. Connections - control	14
7.1 Software and apps.....	15
7.2 IP Controllers	15
7.3 Connection over WAN.....	15
7.4 TCP Protocol.....	16
8. Dimensions.....	17
9. Technical specs.....	18
10. Processing specs	19

1. Introduction

AHM-64 is an audio matrix processor for sound management and installation. It is designed for audio distribution, paging, conferencing, speaker processing in a multitude of environments including corporate, hospitality, education, event and multi-purpose venues, retail, theatres, cruise ships, sports venues.

The AHM-64 processor is complemented by an extended ecosystem of remote audio expanders, remote controllers, interfaces, apps and software. A family of portable, rack-mountable or wall-mount audio expanders is available with a choice of proprietary point-to-point Layer-2 or Dante transport protocols.

AHM-64's scalability supports up to 268 system inputs and system outputs, and up to 96 IP remote controllers for volume control, music source selection, preset recall and more. It can also integrate with third party devices over GPIO, TCP/IP, or industry standard control systems. The Custom Control editor and app from Allen & Heath offer more control options with tailored user interfaces for multiple users and device types, with kiosk and BYOD capability.

1.1 AHM-64 features

AHM-64 features at a glance:

- 64x64 processing matrix
 - 12x12 local analogue I/O
 - I/O Port for audio networking, up to 128x128
 - Dante 96kHz 64x64 optional card (AES67 and DDM ready)
 - 128x128 built-in SLink port for audio expansion
 - 64 configurable processing outputs – up to 64 mono / stereo zones
 - Sound management tools
 - 8x Automatic Mic Mixers
 - AEC (Acoustic Echo Cancellation)*
 - ANC (Ambient Noise Compensation)
 - Priority ducking
 - 8-band PEQ, dynamics and delay on every input and zone
 - Speaker processing with x-over filter, delay, limiter and PEQ
- *with optional module
- 96kHz FPGA core with ultra-low latency
 - Compatible with Allen & Heath IP1, IP6, IP8 remote controllers
 - 2x2 local GPIO plus networkable GPIO interface
 - DC backup power supply
 - System Manager software
 - Custom Control app and editor
 - 32 user profiles
 - Integrated stereo / dual mono playback
 - Event scheduler

2. Installing AHM-64

2.1 Free standing

For free standing or shelf operation, check that the plastic feet are fitted. Ensure adequate air flow around the unit. It must not be covered in any way. Always stand the unit on a firm flat surface away from any soft furnishings or carpet.

2.2 Rack mounting

AHM-64 is 19-inch rack mountable and occupies 2U of rack space. The plastic feet may need to be removed before rack mounting; retain them for future use.

- ⓘ Ensure natural convection of airflow around the unit by allowing good ventilation in front of and behind the unit. Rack equipment known to produce a significant amount of heat should not be mounted directly above or below the unit. Forced convection by means of a rack mounted fan-tray may be desirable in situations where space is restricted, and the ambient air temperature is high.

2.3 Rear rack kit

A kit is available for extra rack support of AHM-64, securing the unit to the rear of a rack cabinet in environments where vibration or mechanical stress are of concern. The rear rack kit is extendable and can fit racks between 485mm and 600mm deep.

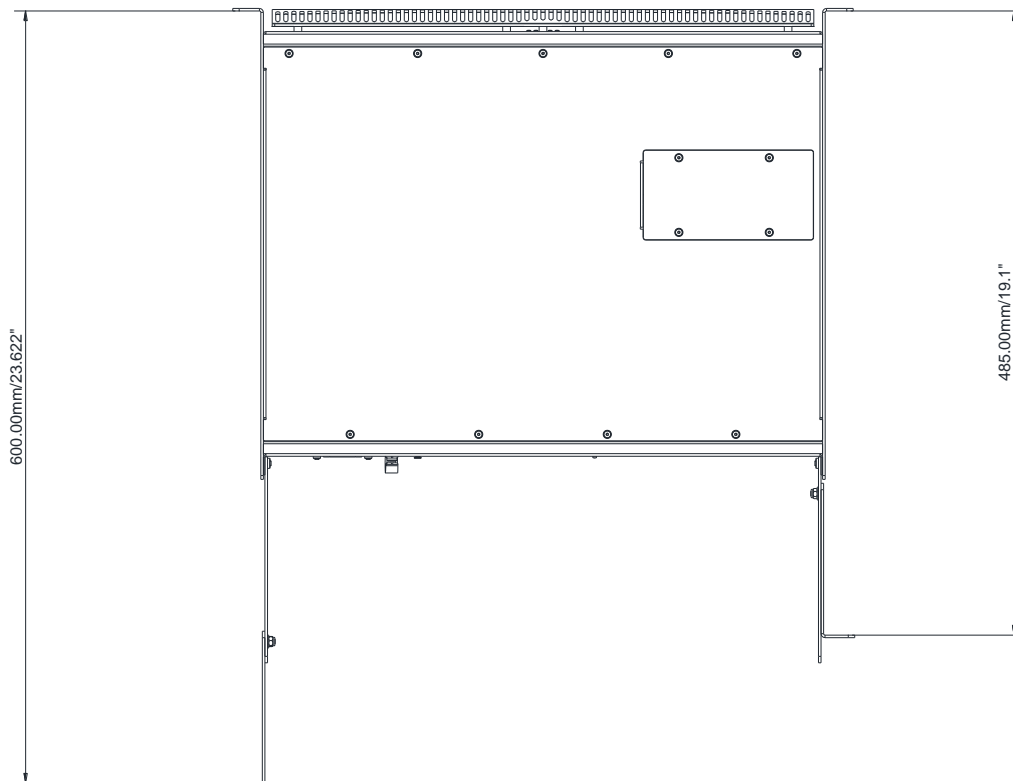

3. Front Panel

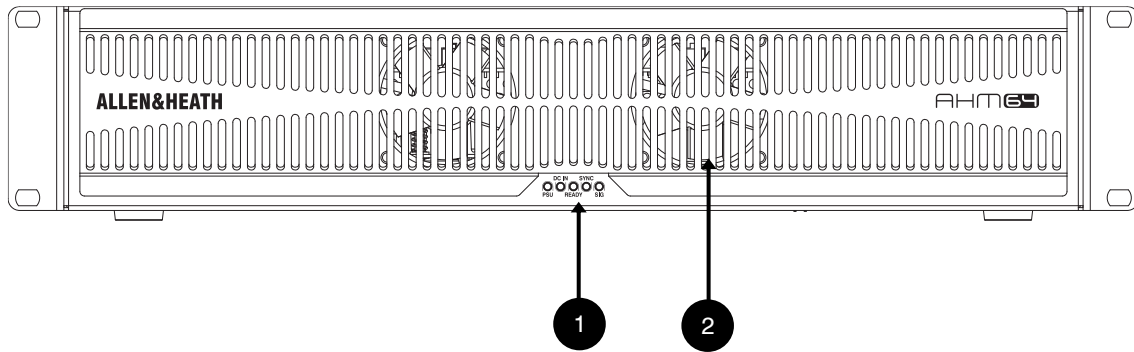

1. Status LEDs



- PSU** Correct functioning of the internal, universal power supply.
- DC In** Valid 12V supply connected to the DC Input.
- Ready** Unit is correctly powered up and ready to pass audio.
- Sync** Audio is sync locked to a valid clock source.
- Sig** Assignable Chromatic meter with variable colour and brightness. Factory default measures the highest level across all input and output channels, with peaks flashing red.

2. Fans

Variable speed with temperature sensing. Make sure the ventilation opening is not obstructed.

4. Rear Panel

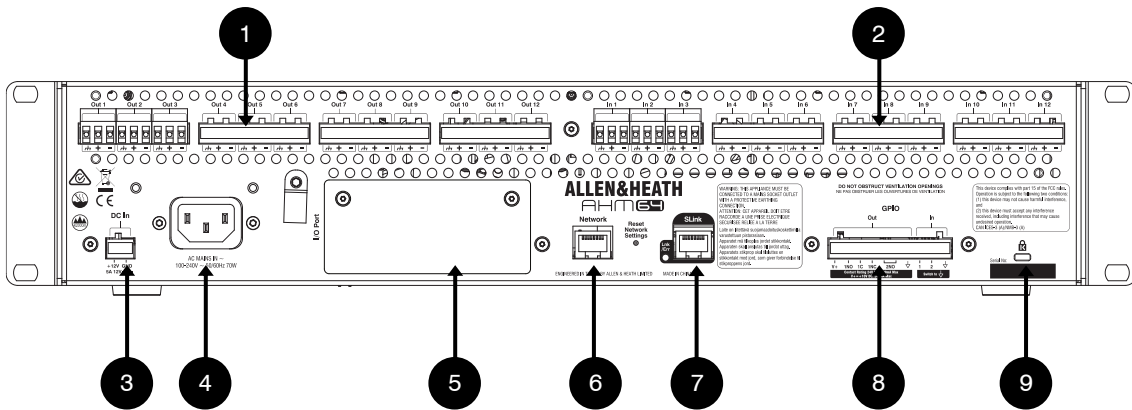

1. Line Outputs

12x assignable line level, balanced outputs on Phoenix connectors. Nominal level +4dBu. The outputs are relay protected to prevent power on or off thumps.

Use the provided 3-pin Phoenix connectors with strain relief for optimal cable management.

2. Mic/Line Inputs

12x recallable preamps on Phoenix connectors, for balanced or unbalanced microphone and line level signals. Gain, Pad and 48V are digitally controlled within the preamp.

Any socket can be patched to any of the 64 Input Channels or Insert Returns.

Use the provided 3-pin Phoenix connectors with strain relief for optimal cable management.

3. DC Input

12V input for backup power supply. The IEC and DC connectors can be connected at the same time for power supply redundancy in case of a mains power loss.

Use the provided 2-pin Phoenix connector with strain relief for optimal cable management.

4. Mains

IEC inlet with universal power supply (100-240V AC, 50-60Hz). The internal PSU is the primary supply and overrides the DC Input unless a fault occurs.

A plastic P-clip cable clamp is provided to secure the mains cable. Slot the cable in or lock it in place using a star Torx® T20 screwdriver to refit the clamp around the cable.

5. I/O Port

Audio interface port providing up to 128x128 I/O. Fit one of the option cards available for system expansion, distributed audio networking or system integration. Refer to www.allen-heath.com for a list of available option cards.

i For Dante audio networking, use the M-SQ-DANT64 (SQ Dante V2) card, not the original M-SQ-DANTE card.

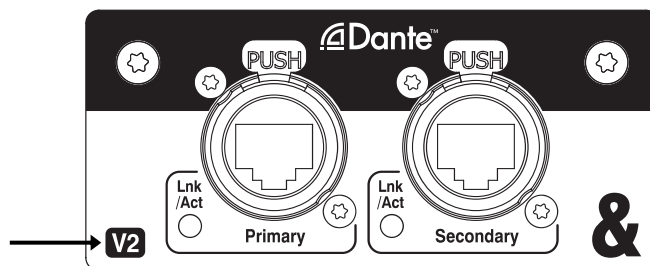

6. Control Network

RJ45 Gigabit Ethernet port. Connect a laptop, wireless router or switch to use with the AHM-64 System Manager, IP remote controllers, Custom Control app or TCP control. All devices on the network must have compatible IP addresses.

- ⓘ A recessed switch lets you reset the network settings to factory default. To reset, turn the unit off, insert a pointed object to press and hold the switch whilst turning the unit back on. Hold the switch in for at least 20 seconds.

7. SLink

For connection to remote I/O expanders with plug 'n play operation. Supports the GX, DX, AB and AR ranges of expanders plus the DX Hub. It can also be used for connection to an Allen & Heath SQ, Avantis or dLive live mixing console, or linking to another AHM-64 unit.

The Lnk/Err LED flashes yellow at a steady rate when the link is established, and lights red if a communication error is detected.

8. GPIO

General purpose interface for control integration with third party hardware. Offers 2x inputs switching to ground, and 2x relay outputs on Phoenix connectors, in addition to a +10V DC output.

- ⓘ Maximum current drawn from the +10V supply for all outputs combined must not exceed 200mA

Output 1 can be wired as normally closed or normally open. Output 2 is normally open.

For higher current or voltage applications, an external DC power supply may be used. This also provides total isolation between the AHM-64 and external equipment.

- ⓘ Maximum external supply voltage must not exceed +24V DC. Maximum current sink through any open collector output must not exceed 400mA.

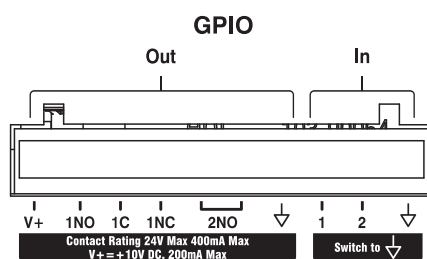

Use the provided 10-pin Phoenix connector with strain relief for optimal cable management.

9. Kensington lock

Slot for securing the unit or peripheral devices using industry standard Kensington locks and cables.

5. Top Panel

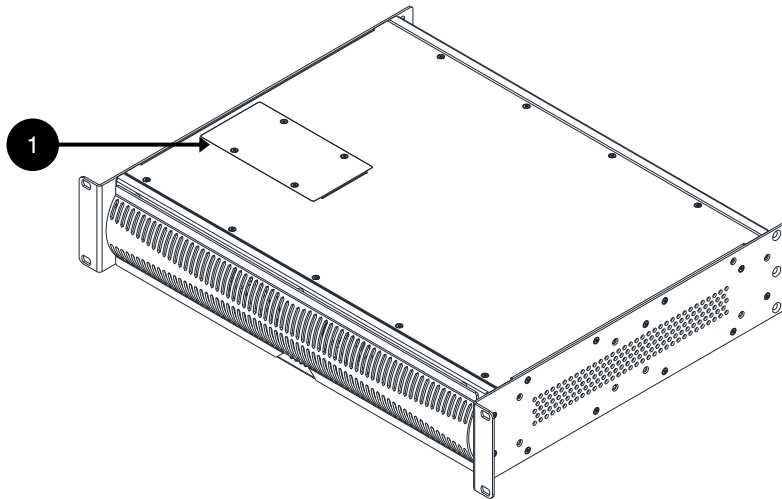

1. Optional module

Slot for optional processing module. Refer to www.allen-heath.com for a list of available modules. Follow the fitting instructions of the optional module for installation.

⚠ Installation of any optional module must only be carried out by technically skilled personnel.

6. Connections - Audio

For all audio connections, use CAT5e (or higher specification) STP cables up to 100m long.

- ① Refer to www.allen-heath.com for cable requirements, recommendations, and a list of CAT cables available to order.

6.1 Audio expanders over SLink

When an audio expander is connected, the SLink port detects the type of device and automatically switches to the relevant Allen & Heath protocol, sample rate and Ethernet speed. The table below lists compatible audio expanders. Visit allen-heath.com/everything-io/ for more information on our range of expansion options.

	Sample Rate	Inputs	Outputs	Connection	Protocol	Ethernet speed
GX4816	96kHz	48	16	SLink port	gigaACE	Gigabit
DX32	96kHz	<32		SLink port or DX Hub	DX	Fast Ethernet
DX168	96kHz	16	8	SLink port or DX Hub	DX	Fast Ethernet
DX164-W	96kHz	16	4	SLink port or DX Hub	DX	Fast Ethernet
DX012	96kHz	0	12	SLink port or DX Hub	DX	Fast Ethernet
DX Hub	96kHz	128	128	SLink port	gigaACE	Gigabit
AR2412	48kHz	24	12	SLink port	dSnake	Fast Ethernet
AR84	48kHz	8	4	Slink port	dSnake	Fast Ethernet
AB168	48kHz	16	8	Slink port	dSnake	Fast Ethernet

At connection or power up, AHM-64 will check the firmware version of the expander device and upgrade or downgrade the device to match the main unit firmware.

Up to 2x dSnake 48kHz expanders can be daisy-chained over SLink, provided the first expander is an AR2412 or AB168, and the second expander is an AB168 or AR84. Connection of 2x AR2412 is not supported.

Up to 2x DX168, DX164-W, DX012 expanders in any combination can be daisy-chained over SLink. AHM-64 does not support redundant connection to DX expanders.

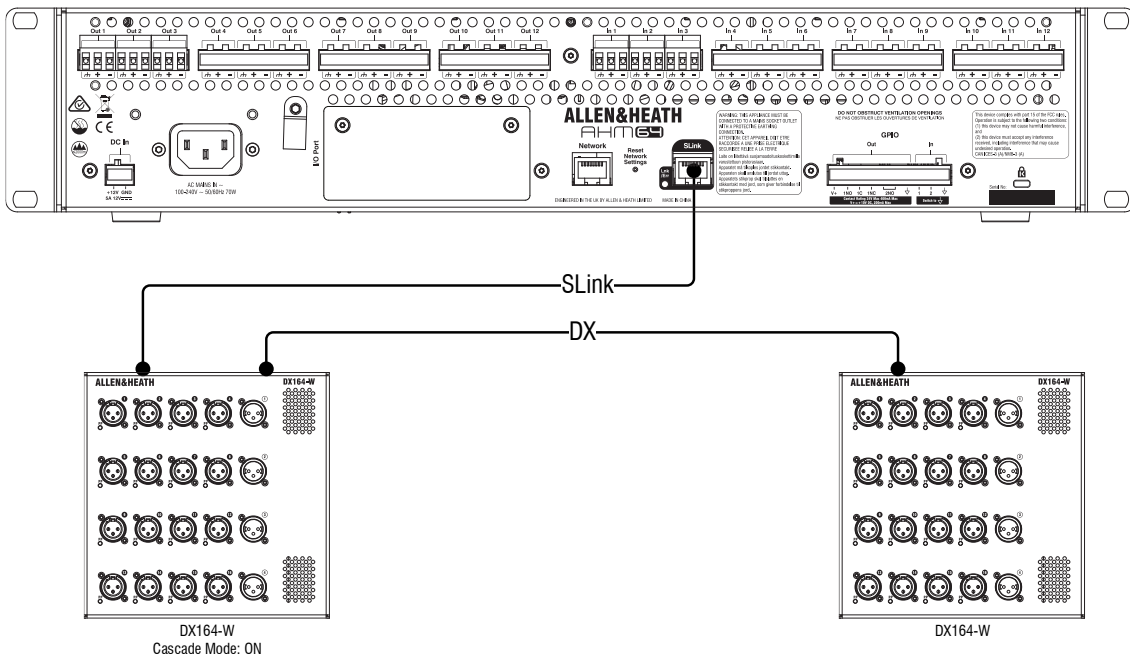

A DX Hub can be connected to the SLink port for further expansion with up to 8 DX expanders. It also enables a single cable link to the AHM-64 processor in cases where multiple expanders are located on a different floor, area or building.

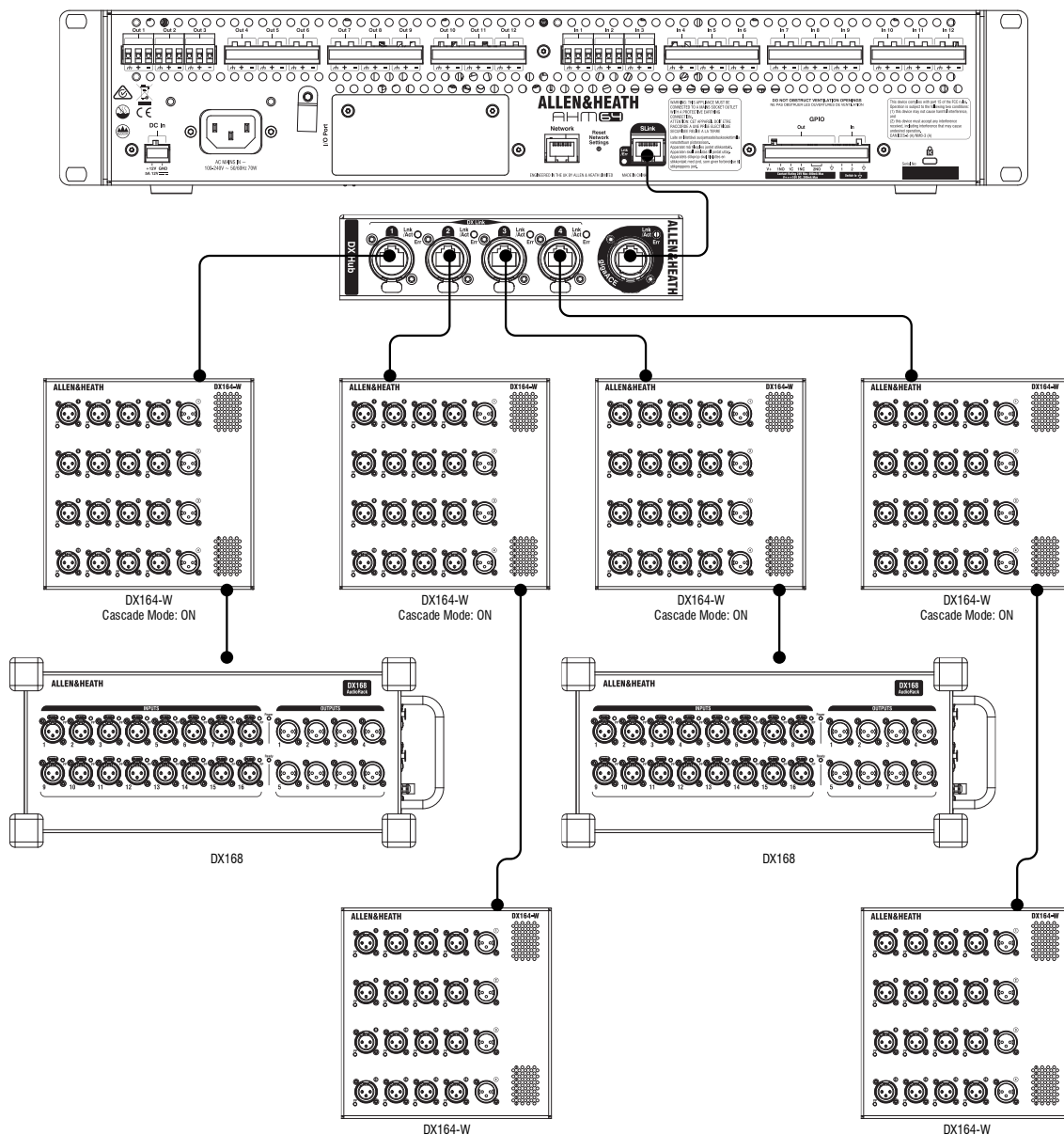

6.2 Audio expanders and Ethernet

All protocols listed above are point-to-point connections, Ethernet Layer 2 compliant. gigaACE operates at Gigabit Ethernet speed (1000BASE-T, IEEE 802.3ab). DX and dSnake operate at Fast Ethernet speed (100BASE-TX, IEEE 802.3u).

Layer 2 network devices and media converters can be used, provided they support the correct link speed. Typical applications include conversion to fibre optic for longer cable runs, or integration within an existing Ethernet infrastructure. Refer to the following guidelines and always test the network for functionality and reliability before putting into service. Further advice and notes on VLANs, TCP ports and bandwidth are available on the online Allen & Heath Knowledgebase and website.

- ❗ Layer 2.5 and higher protocols including Spanning Tree, Tagged Egress Packets, and Broadcast Storm Protection can cause interruption to audio data or audible clicks. Smart / managed switches may allow turning off Layer 3 or 4 functions, but as a general rule we recommend using Layer 2 devices only.
- ❗ Note that no other device should be plugged into a switch carrying gigaACE, dSnake or DX audio. Parallel connection of multiple expanders on the same switch is not possible.

6.3 Other SLink connections

The SLink port can be connected directly to another AHM-64 unit, an SLink enabled Allen & Heath mixer such as SQ or Avantis, or a dLive system fitted with a gigaACE card. This connection enables 128x128 channels of audio.

- ❗ Set the Audio Sync options so that one device is master clock (set to 'Internal') and the other device is slave (set to sync from SLink or I/O Port as appropriate).
- ❗ The SLink port does not tunnel control network data. Use the Network port to connect multiple AHM-64 units or other Allen & Heath mixers for control purposes, for example for Embedded Scene Recalls or System Manager operation.

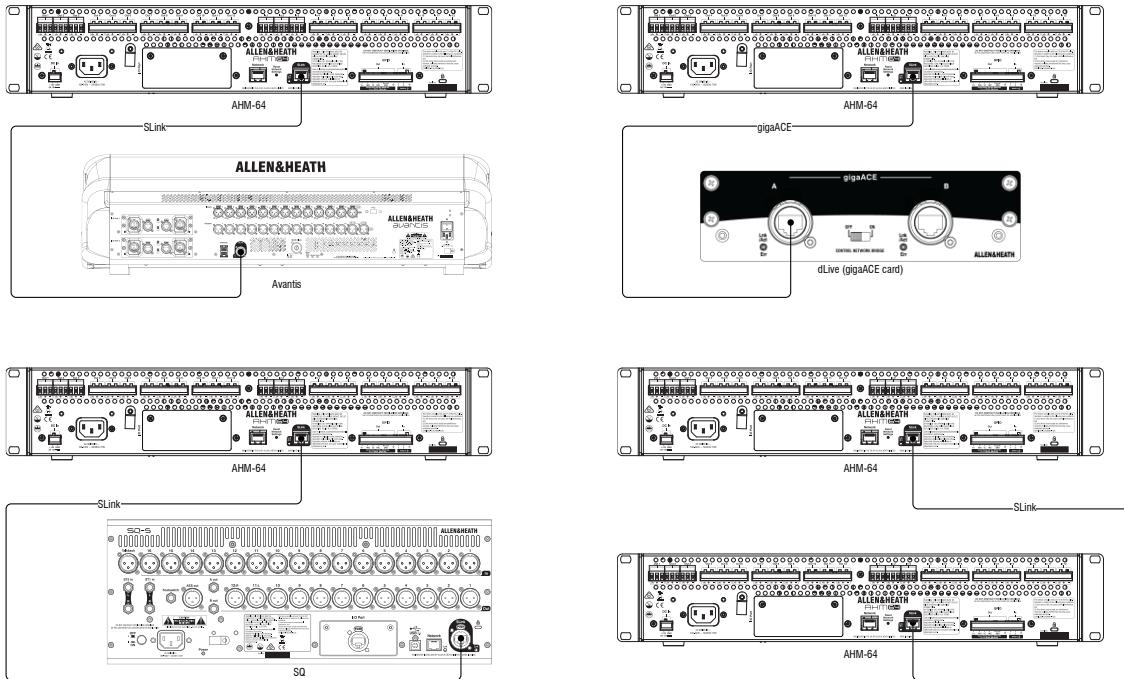

6.4 Dante expanders

Control of the DT168 or DT164-W expanders requires an M-SQ-DANT64 (SQ Dante V2) card fitted in the I/O Port.

Use Dante Controller to patch signals between Dante devices. When a valid DT168 or DT164-W socket is routed to AHM-64, and patched to an Input channel, System Manager will present preamp gain, +48V and Pad controls for the socket.

DT expanders should always be slave on the Dante network, with the AHM-64 processor typically set to 'Preferred Master' and 'Enable Sync to External'.

- ❗ Refer to the DT expander Getting Started Guide at www.allen-heath.com for further information.

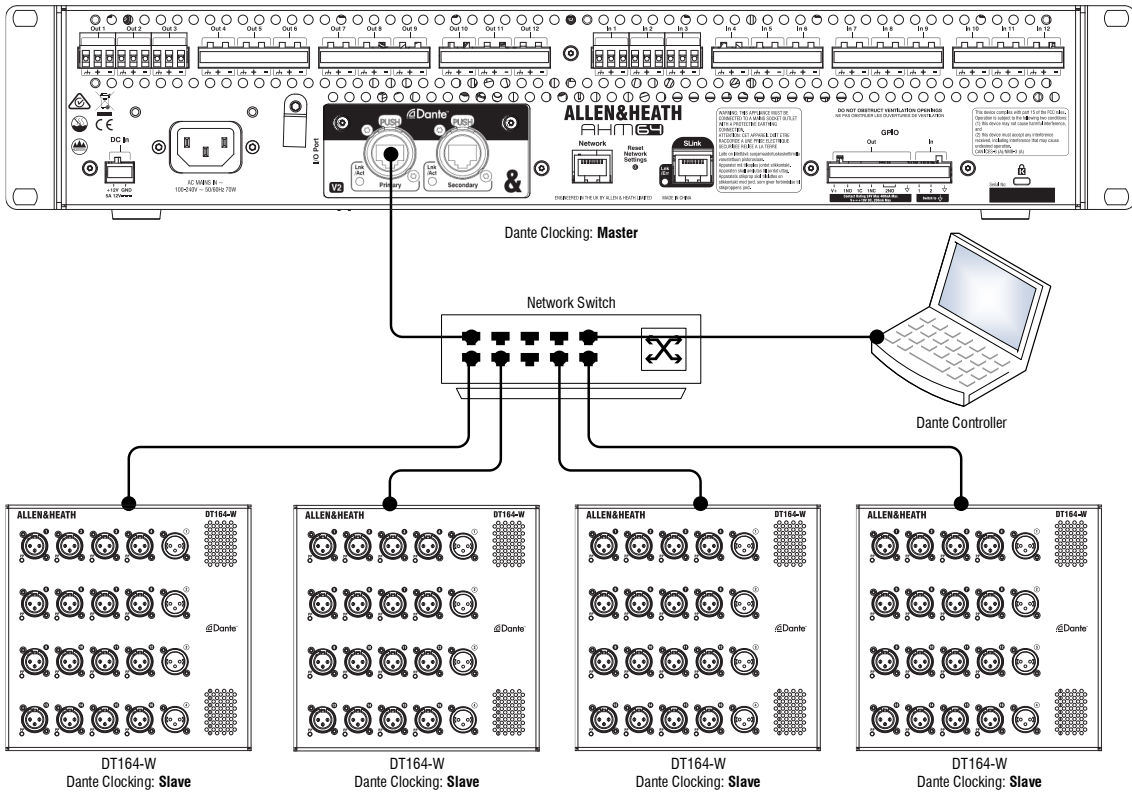

7. Connections - Control

A computer, wireless router or switch can be connected to the Network port to use with the AHM-64 System Manager, IP remote controllers, Custom Control app or TCP control.

For all connections, use CAT5e (or higher specification) cables up to 100m long.

- ① Refer to www.allen-heath.com for cable requirements, recommendations, and a list of CAT cables available to order.

AHM-64 communicates over TCP/IP. All devices on the network must have compatible IP addresses. Factory defaults for AHM-64 are:

IP Address **192.168.1.90**
Subnet Mask 255.255.255.0
Gateway 192.168.1.254

- ① AHM-64 supports up to 100 TCP connections. These include any IP controller, GPIO interface, System Manager or Custom Control instance. More information is available on the online Allen & Heath Knowledgebase.

7.1 Software and apps

For direct, wired laptop connection using System Manager or the Custom Control editor, set the laptop to a static, compatible IP address, for example **192.168.1.10**.

For LAN or wireless connections, including Custom Control apps, set the router / access point to a compatible IP address, for example 192.168.1.254, and its DHCP range to a compatible range of addresses, for example **192.168.1.100** to **192.168.1.200**. Set any laptop, tablet or mobile device to DHCP / 'obtain an IP address automatically'.

7.2 IP Controllers

AHM-64 is compatible with the remote controllers and GPIO interfaces listed below. All devices listed here can be set to DHCP if required.

	Description	Default IP	PoE
IP1	Wallmount remote controller with dual-function rotary encoder.	192.168.1.74	802.3af
IP6	Remote controller with 6 push-and-turn rotary encoders.	192.168.1.72	802.3af
IP8	Remote controller with 8 motorised faders.	192.168.1.73	802.3at
GPIO	8x8 general purpose interface for control integration.	192.168.1.75	802.3af

The function of the IP controllers and GPIO is configured via the AHM System Manager.

At connection or power up, AHM-64 will check the firmware version of the IP controllers and GPIO and upgrade or downgrade the device to match the main unit firmware.

Visit www.allen-heath.com for more information on our range of remote controllers.

7.3 Connection over WAN

For connection of System Manager or Custom Control over a WAN, TCP port **51321** should be forwarded by the NAT to the IP address of the AHM-64 processor.

- ① We strongly recommend using a secure VPN to access the local network. When connecting directly over the Internet, use a good quality firewall and NAT to block ports when not in use.

7.4 TCP Protocol

A TCP Protocol for control and interrogation of AHM-64 parameters is available and documented at www.allen-heath.com. Clients should be configured to use TCP port **51325** (unsecured) or the TLS/TCP port **51327**.

- ① Check www.allen-heath.com for drivers or project templates for leading control systems such as Crestron or AMX.

8. Dimensions

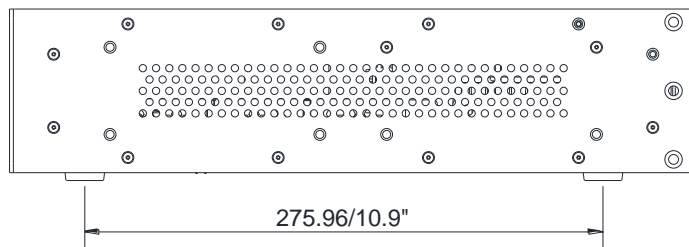
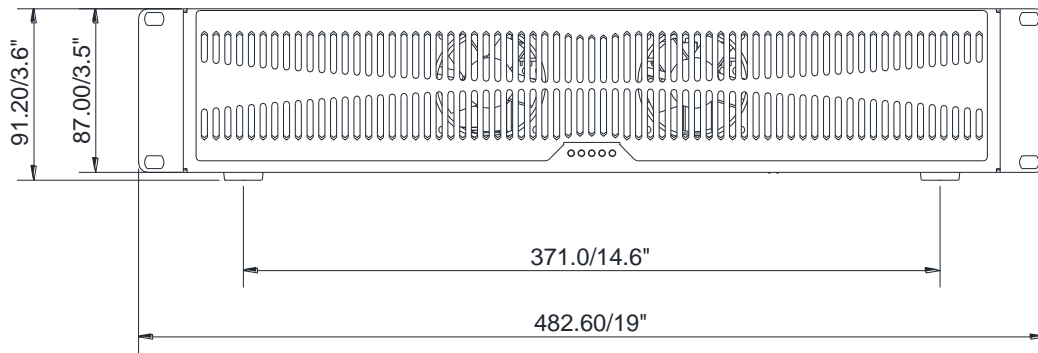
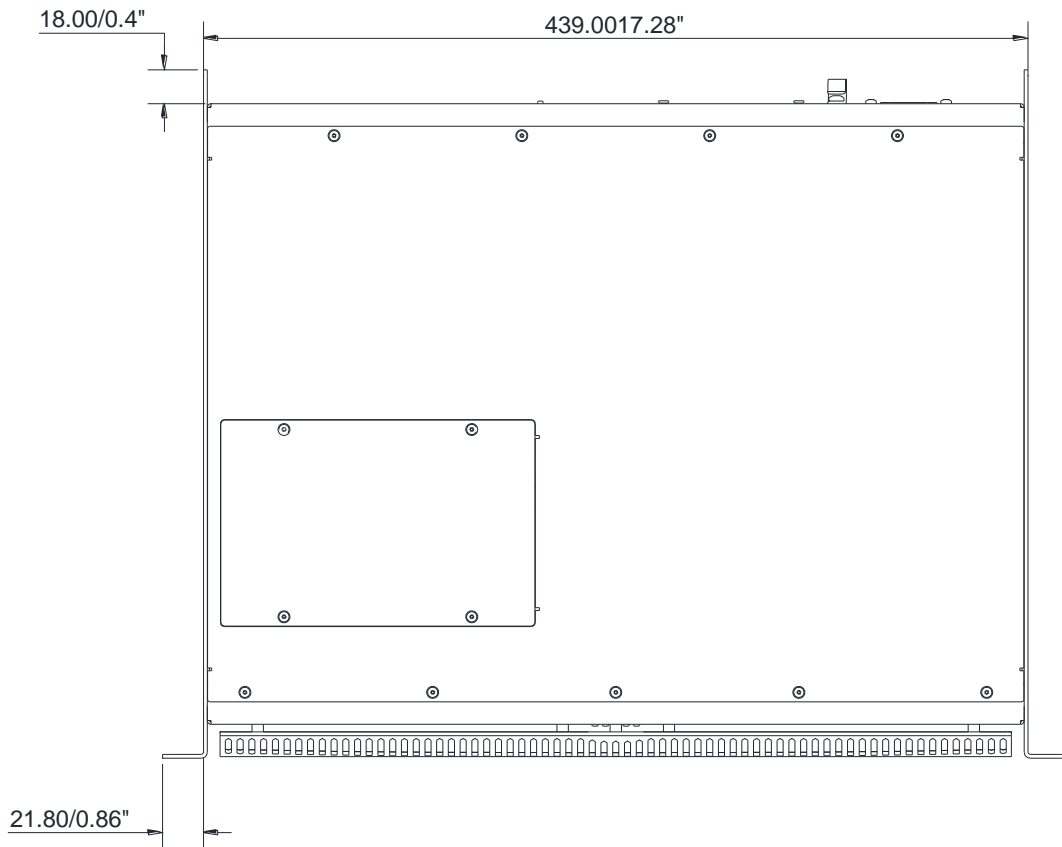

9. Technical specs

Inputs

Mic/Line Inputs	Balanced, +48V phantom power
Mic/Line Preamp	Fully recallable
Input Sensitivity	-60 to +15dBu
Analogue Gain	+5 to +60dB, 1dB steps
Pad	-20dB Active PAD
Maximum Input Level	+30dBu (PAD in)
Input Impedance	>3k Ω (Pad out), >8k Ω (Pad in)
Mic EIN	-127dB with 150 Ω source

Outputs

Analogue Outputs	Balanced, Relay protected
Output Impedance	<75 Ω
Nominal Output	+4dBu = 0dB meter reading
Maximum Output Level	+22dBu
Residual Output Noise	-94dBu (muted, 20-20kHz) -92dBu (muted, 20-40kHz)

Dimensions and Weights

Unboxed	Width x Depth x Height x Weight
AHM-64	482.6mm x 364mm x 91.2mm x 7kg (19" x 14.3" x 3.6" x 15.5lbs)
Boxed	
AHM-64	600 x 500 x 180 mm x 9.5kg (23.6" x 19.7" x 7.1" x 21lbs)

System

Measured balanced XLR in to XLR out, 20-20kHz, +5dB Gain, Pad out, signal @ 0dB (meter)	
Dynamic Range	110dB
System Signal to Noise	-94dB
Frequency Response	20Hz - 25kHz +0/-0.8dB
THD+N (analogue in to out)	0.005% @ +16dBu output, 1kHz +5dB gain
Headroom	+18dB
Sampling Rate	96kHz +/- 20 PPM
ADC	32-bit Delta-Sigma
DAC	32-bit Delta-Sigma

Playback

Internal Storage	~3GB
File types	Mono/stereo .WAV (16/24bit, 44.1/48/96kHz), MP3, FLAC

Operating Temperature Range	0 deg C to 40 deg C (32 deg F to 104 deg F)
Mains Power	100-240V AC, 50-60Hz, 70W max
DC Power	12VDC - 5A minimum 8A maximum

10.Processing specs

Input Processing

64 Input Channels	Configurable mono or stereo
Trim	+/-24dB digital trim
Polarity	Normal/Reverse
Stereo Width Control	L/R, R/L, L -Pol/R, R -Pol/L, Mono, L/L, R,R, M/S
Gate	
Sidechain	Self-key or source selectable, with 12dB/octave Lo-Pass and Hi-Pass
Threshold	-72dBu to +12dBu
Depth	0 to 60 dB
Attack	50us to 300ms
Hold	10ms to 5s
Release	10ms to 1s
Insert	In/Out, +4dBu/-10dBV level
PEQ	
Type	8-Band fully parametric, +/-15dB
Band 1 - 8	Selectable LF/HF Shelving, Bell (variable or constant Q), Hi-Pass / Lo-Pass, Notch
Bell Width	0.50 – 6.00 Q
Shelving Type	Classic Baxandall
Hi-Pass, Lo-Pass Filter	12dB/octave
Compressor	Peak or RMS sensing
Sidechain	Self-key or source selectable, with 12dB/octave Lo-Pass and Hi-Pass
Threshold	-46dBu to 18dBu
Compressor parameters	Threshold, Ratio, Attack, Release
Delay	Up to 683ms

Zone Processing

Up to 64 Zones	Configurable mono or stereo
Source Selector	Up to 20 sources, variable level, Fade In and Fade Out time <20s
Insert	In/Out, +4dBu/-10dBV level
GEQ	28 bands 31Hz -16kHz, +/-12dB, constant-Q
PEQ	See Input Processing
Compressor	See Input Processing
Delay	Up to 683ms
ANC	
Ambient Level	Selectable source and metering point, Gain Differential -18dB to 40dB
Gap	Selectable source and metering point, Threshold -62dB to -20dB, Time 0-5000ms
Gain Element	Min / Max Gain, Rate 0-30dB/s
Limiter	Variable Threshold, Attack and Release
Speaker Processing	
Crossovers	Configurable 2, 3, 4 way
Filters	Asymmetrical, selectable 1 st order, Butterworth 12/18/24 db/octave, LR 12/24 dB/octave
PEQ	4-Band fully parametric
Delay	Up to 683ms
Limiter	See Zone Processing
AMM	
Channels	1x64, 2x32, 4x16 or 8x8
Modes	D-Classic gain sharing or NOM