

**DENON**  
*PROFESSIONAL*

**DN-900R**

**Serial Command Protocol Guide**  
English

## Table of Contents

Introduction.....	3
Support.....	3
General Overview .....	3
Connecting the Host to DN-900R .....	3
Communication Protocol.....	5
Types of Serial Communication.....	5
Structure of the Codes.....	6
Rules on Transmitting Command Codes .....	6
Control Command Codes.....	7
Status Request Command Codes/Status Information Codes .....	24
Automatic Status Information Codes.....	42
Appendix.....	44
Acceptable Characters for Serial Communication.....	44
Entering the Absolute Path for Folder and File Names.....	45
RS-232C Specifications .....	46
Ethernet Specifications .....	46
Trademarks & Licenses.....	46

## Introduction

Thank you for purchasing the DN-900R. At Denon Professional, performance and reliability mean as much to us as they do to you. That's why we design our equipment with only one thing in mind—to make your performance the best it can be.

## Support

For the latest information about this product (documentation, technical specifications, system requirements, compatibility information, etc.) and product registration, visit [denonpro.com](http://denonpro.com).

For additional product support, visit [denonpro.com/support](http://denonpro.com/support).

## General Overview

With serial remote control, a “host” machine (such as a PC running proper software) can be used to operate your DN-900R. Throughout this document, the equipment used to control DN-900R will be called the **Host**.

To learn more about the different types of serial communication and the code structure it requires, see the [Communication Protocol](#) section that starts on the next page. To view the complete list of serial command codes (with descriptions of each code's function), see the [Control Command Codes](#), [Status Request Command Codes/Status Information Codes](#), and [Automatic Status Information Codes](#) sections later in this manual.

To view a condensed list of all the serial command codes (with no code descriptions), download the *Serial Command Code List* from the **Downloads** tab of DN-900R's product page at [denonpro.com](http://denonpro.com). This document may be useful if you would like to print a hardcopy list of the codes.

## Connecting the Host to DN-900R

For serial remote control, you must first connect the host to your DN-900R by taking one of the following three steps:

### Example 1

Use an RS-232C straight cable (9-Pin D-Sub Male) to connect the RS-232C input on the rear panel of your DN-900R to the corresponding output on the host.

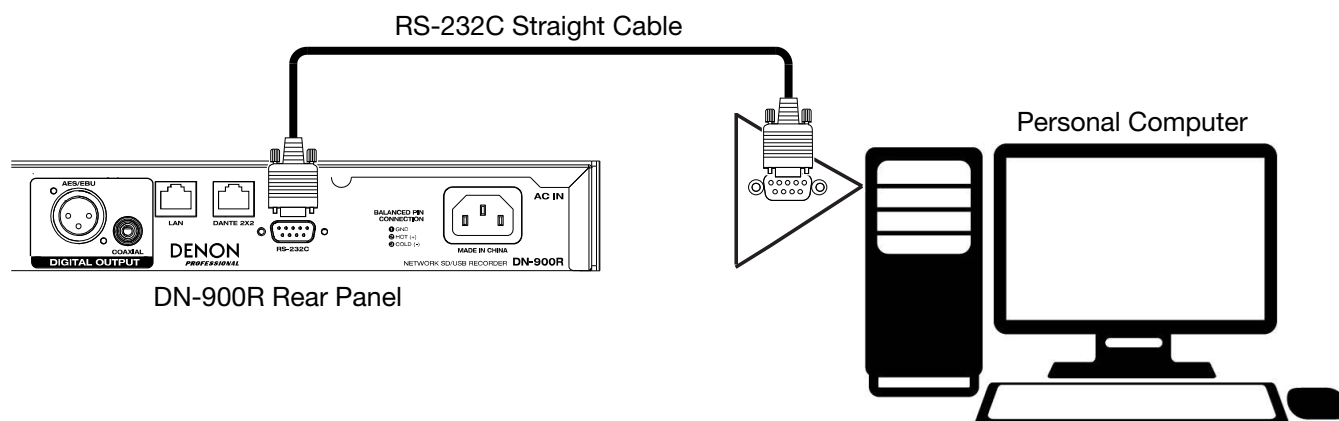

### Example 2

Use an ethernet cable to connect the LAN port on the rear panel of your DN-900R to the corresponding port on the host.

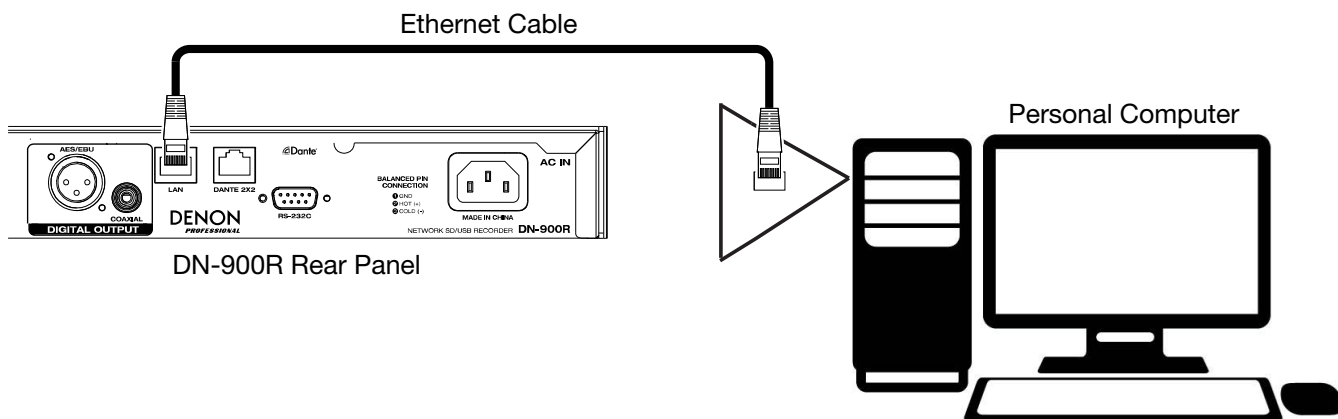

### Example 3

Use an ethernet cable to connect the LAN port on the rear panel of your DN-900R to a router that the host is also connected to.

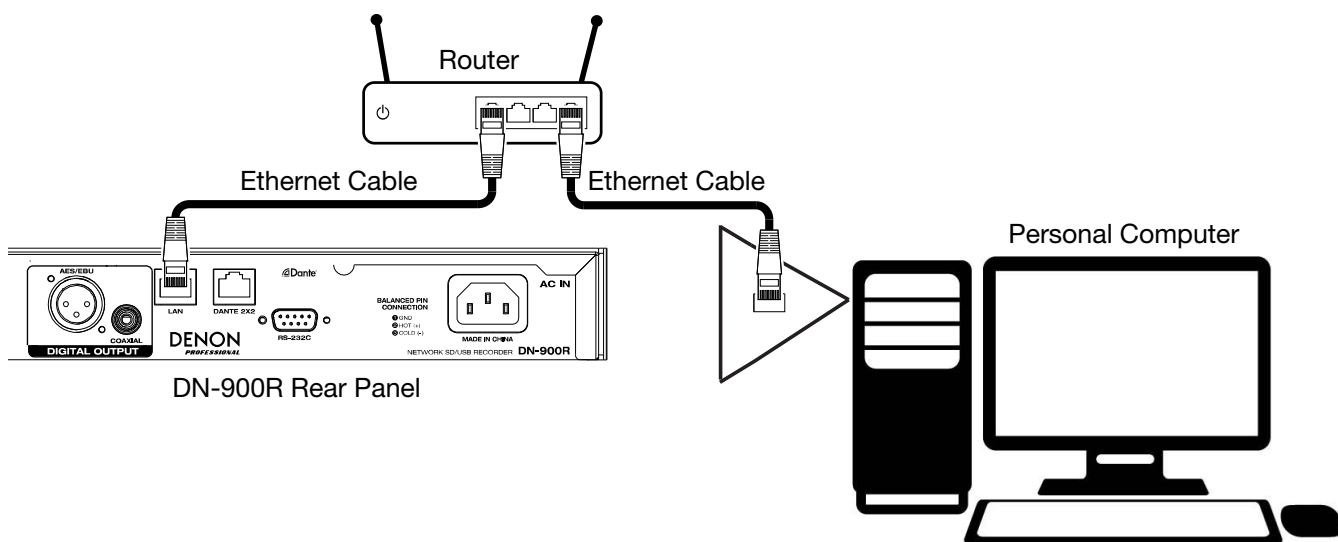

**Note:** Only one network user can be connected to DN-900R at a time. This means that two different computers cannot be used for serial communication with DN-900R at the same time, and you cannot use the LAN port for serial communication while DN-900R is already being controlled by the web browser remote.

After setting up for serial communication via an ethernet connection, entering the preset Admin password will be required if the **IP Control Auth** setting is set to **On** in your DN-900R's system settings. To enter the password, you will need to send the "Admin Password" status request command (included on page 24 in the [Status Request Command Codes/Status Information Codes](#) table). This code is **@0?Llxxx\r**, where xxx stands for the password.

If the correct password is entered in the "Admin Password" status request command, DN-900R will answer the host with the login successful code: **@OLIOK\r**. If the incorrect password is entered in the "Admin Password" status request command, DN-900R will answer the host with the login failed code: **@OLING\r**. After you receive the login failed code, you can try again to enter the password.

## Communication Protocol

### Types of Serial Communication

Three types of serial communication can be transmitted between the host and DN-900R:

1. Control commands sent to DN-900R from the host

You can use control commands to make DN-900R perform a desired function (such as initiating a recording or playing a track).

When DN-900R successfully receives a control command from the host, DN-900R sends an ACK signal to the host and then executes the command.

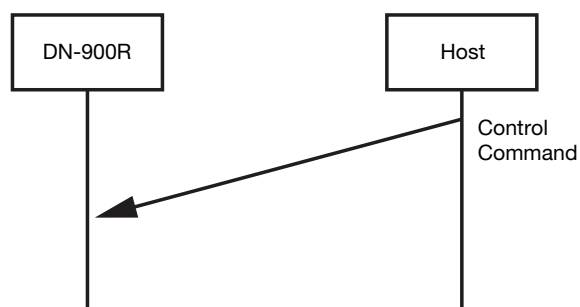

2. Status request commands sent to DN-900R from the host

You can use a status request command to determine the current state of one of DN-900R's components (such as the amount of free space left on the media source or the currently selected recording input).

When DN-900R successfully receives a status request command from the host, DN-900R answers the host with an ACK signal followed by the requested status information.

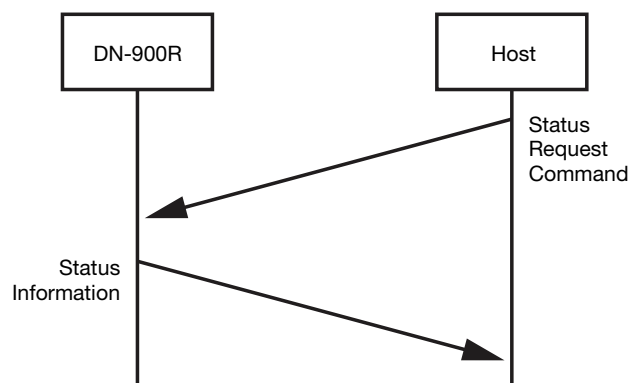

3. Status information automatically sent to the host when a change is made from DN-900R

When certain changes to DN-900R are made from the device itself, DN-900R automatically sends status information to the host. When the host receives automatic status information successfully, it sends an ACK signal to DN-900R.

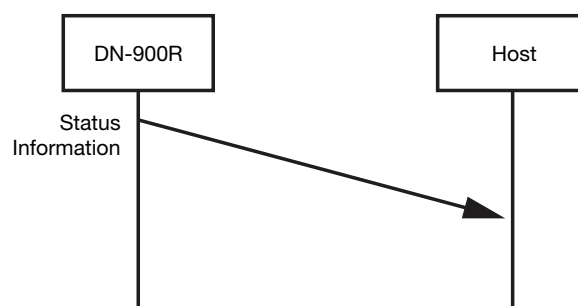

## Structure of the Codes

Serial communication between the host and DN-900R uses ASCII Code from 0x20 to 0x7F.

All control command codes, status request command codes, and status information codes require three components that form a “packet.” In order, the components are the **start character + ID**, the **command**, and the **end character** (0x0D):

1. Start Character + ID: @ (0x40) + 0 (0x30)
2. Command: some letters and/or numbers that stand for a controllable feature of DN-900R
3. End Character: \r (0x0D)

The required start character/ID and end character are the same in all codes, whereas the command portion varies with each code.

For example, the full control command code that the host can use to power on DN-900R is **@023PW\r**:

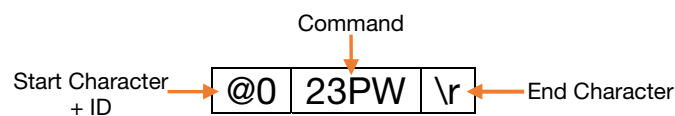

## Rules on Transmitting Command Codes

- When DN-900R receives a control command or status request command from the host, DN-900R should respond within 300 ms.
- When DN-900R successfully executes a command that it receives from the host, DN-900R sends an ACK signal (0x06) to the host (as well as the status information code in the case of a status request command).
- If DN-900R receives an unknown command from the host or if a received command fails for some other reason, DN-900R will send a NACK signal (0x15) to the host.
- When sending consecutive commands from the host, do not send the second command until DN-900R has answered the first with the ACK (0x06) or NACK (0x15) signal. If the second command is sent before the ACK (0x06) or NACK (0x15) signal is received, DN-900R will send the “Busy” status information code (**@0BDERBUSY**) to the host.
- If DN-900R does not receive a command that the host sent within 300 ms, the host will automatically send the same command up to two additional times. If DN-900R still does not receive the command after the second automatic attempt, the process will timeout, and the host will send the end character to DN-900R.
- Do not send a second status request command from the host until DN-900R has responded to the first.
- When sending a command to DN-900R from the host, make sure that no longer than 5 ms passes between entering each character in the command code.
- All characters used in codes transmitted between the host and DN-900R must fall within the bounds of the acceptable character table in the [Appendix](#).
- Wait at least one second after sending the Power On command before sending the next command.
- When status information is automatically sent to the host after a change to DN-900R is made from the device itself, the host will send an ACK (0x06) signal to DN-900R. If DN-900R does not receive the ACK signal within 300 ms, it will automatically send the status information to the host again. If DN-900R then fails to receive the ACK (0x06) signal again, the process will timeout.

## Control Command Codes

Use the codes below to control your DN-900R.

In cases where the control command code includes a variable, the variable is indicated in *italicized font* and the potential values are indicated in **bold font**.

Control Commands (Host → DN-900R)			
CATEGORY	CONTENTS	CODE	DESCRIPTION
Power/Media	Power On	@023PW\r	Powers on DN-900R
	Power Standby	@02312\r	Puts DN-900R in standby
	Set Power On Mode	@0POXX\r	Changes the default mode that DN-900R will enter when it is powered on, where <i>XX</i> (the mode) = <b>RM</b> (resume playback of the last played track), <b>PF</b> (play the first track in the last used folder), <b>ST</b> (stop playback), or <b>RE</b> (begin recording to the last selected media source)
	Select Media Source	@0MMXX\r	Selects the media source, where <i>XX</i> (the media source) = <b>S1</b> (SD Card 1), <b>S2</b> (SD Card 2), <b>US</b> (USB drive), or <b>NE</b> (Network)
Recording	Select Recording Input	@0INXX\r	Selects the input to be used as the recording audio source, where <i>XX</i> (the input) = <b>UB</b> (the RCA input), <b>BA</b> (the analog XLR input), <b>DI</b> (the coaxial input), or <b>DB</b> (the AES/EBU input)
	Set Recording Channels	@0CHXX\r	Sets whether recorded files will be set to stereo or mono, where <i>XX</i> (the setting) = <b>ST</b> (stereo), <b>ML</b> (left channel mono), or <b>MX</b> (mixed left and right channel mono at -3 dB)
	Initiate Recording	@02355\r	If One Touch Recording is set to off, the first entry of this command puts DN-900R in recording mode, and the second entry initiates recording If One Touch Recording is set to on, the first entry of this command initiates recording
	One Touch Rec On/Off	@00RN\M\r	Turns One Touch Recording on or off, where <i>NN</i> = <b>00</b> (on) or <b>01</b> (off)
	Pause Recording	@023Rp\r	Pauses an in-progress recording
	Split Recording	@023MT\r	Splits an in-progress recording into two separate files at the point the command is executed
	Rec Monitor On/Off	@023RMN\M\r	Turns the recording monitor feature on or off, where <i>NN</i> = <b>00</b> (on) or <b>01</b> (off)
	Set Input Volume Type	@0VIXX\r	Determines whether the recording input volume can be adjusted or whether it is fixed at 0 dB, where <i>XX</i> = <b>VA</b> (can be adjusted) or <b>FX</b> (fixed at 0 dB)
	Both Channel Volume Up/Down	@023VX\r	Turns the volume of the recording up or down 1.0 dB for both the left and right channels, where <i>X</i> (the direction) = + (up) or - (down)

Control Commands (Host → DN-900R)			
CATEGORY	CONTENTS	CODE	DESCRIPTION
Recording	Left Channel Volume Up/Down	@023LX\r	Adjusts the volume of the left recording channel up or down 1.0 dB, where X (the direction) = + (up) or - (down)
	Right Channel Volume Up/Down	@023RX\r	Adjusts the volume of the right recording channel up or down 1.0 dB, where X (the direction) = + (up) or - (down)
	Adjust L/R balance	@023BX\r	Adjusts the balance of the left and right recording channels, where X = <b>L</b> (increase the volume of the left channel by 1.0 dB and decrease the volume of the right channel by 1.0 dB) or <b>R</b> (increase the volume of the right channel by 1.0 dB and decrease the volume of the left channel by 1.0 dB)
	Adjust Pre-Record Time	@0PRNS\r	Sets the amount of time it will take DN-900R to begin recording after the record command is executed, where N (the amount of time in seconds) = <b>1–5</b> ; if no variable is entered in the command, the pre-record time feature will be deactivated
	Set Format to PCM	@0AFPMN\r	Sets the file format for recordings to PCM and sets the file bit length, where NN stands for the bit length
	Set Format to MP3	@0AFM3NN\r	Sets the file format for recordings to MP3 and sets the file bit rate, where NNN (the bit rate in Kbps) = <b>064, 128, 192, 256, or 320</b>
	Select Current Folder	@0RfCU\r	Sets the currently selected folder as the destination for saving new recorded files
	Select Specific Folder	@0RfFXxxx\r	Sets a specified folder as the destination for saving new recorded files, where xxxx stands for the folder name (absolute path not required)
Advanced Recording Options	Dual Record On/Off	@0dRXX\r	Activates/deactivates dual recording and selects the backup media, where XX = <b>OF</b> (turns dual recording off), <b>S1</b> (turns dual recording on and selects SD Card 1 as the backup media), <b>S2</b> (turns dual recording on and selects SD Card 2 as the backup media), or <b>US</b> (turns dual recording on and selects USB as the backup media)
	Relay Record On/Off	@0rRXX\r	Activates/deactivates relay recording and selects the secondary media, where XX = <b>OF</b> (turns relay recording off), <b>S1</b> (turns relay recording on and selects SD1 as the secondary media), <b>S2</b> (turns relay recording on and selects SD Card 2 as the secondary media) or <b>US</b> (turns relay recording on and selects USB as the secondary media)



Control Commands (Host → DN-900R)			
CATEGORY	CONTENTS	CODE	DESCRIPTION
Advanced Recording Options	Turn Auto Track On/Off	@0AT <hhmm\r< td=""> <td>Sets DN-900R to automatically split an in-progress recording into a new file as soon as a specified interval of time has elapsed, where <i>hhmm</i> (the interval of time in hours and minutes) = <b>0001, 0005, 0010, 0015, 0030, 0100, 0200, 0600, 0800, 1200, 2400</b>; enter <b>0000</b> for the variable to deactivate the auto track function</td> </hhmm\r<>	Sets DN-900R to automatically split an in-progress recording into a new file as soon as a specified interval of time has elapsed, where <i>hhmm</i> (the interval of time in hours and minutes) = <b>0001, 0005, 0010, 0015, 0030, 0100, 0200, 0600, 0800, 1200, 2400</b> ; enter <b>0000</b> for the variable to deactivate the auto track function
	Add Mark	@023121\r	Adds a mark to the track at the current recording position
	Turn Silent Skip On/Off	@0SSNM\r	Determines whether DN-900R will automatically pause recording if the audio input reaches below the specified volume threshold and then automatically resume recording if the audio input reaches above the threshold, where <i>NN</i> = <b>00</b> (turn on silent skip) or <b>01</b> (turn off silent skip)
	Turn Automark On/Off	@0AMNM\r	Determines whether DN-900R will automatically add a mark to tracks once they reach below the specified volume threshold, where <i>NN</i> = <b>00</b> (turn automark on) or <b>01</b> (turn automark off)
	Set Silent Level	@0SLNM\r	Sets the threshold for how quiet the audio input must be in order for a recording to automatically pause when Silent Skip is activated or for a mark to be automatically added when Automark is activated, where <i>NN</i> (the threshold in -dB) = <b>20, 38, 54, or 60</b>
	Set Silent Time	@0SCNM\r	Sets how long the audio input must be below the specified volume threshold in order for recording to be automatically paused when Silent Skip is activated or for a mark to be automatically added when Automark is activated, where <i>NN</i> (the length of time in seconds) = <b>01-05</b>
	Set Sample Rate	@0FSXX\r	Sets the sample rate for recorded files, where <i>XX</i> (the sample rate in kHz) = <b>44, 48, 96</b> or <b>EX</b> (for the AES/EBU input)
	Set File Name Format	@0FfXXX\r	Determines the file name format for recorded files, where <i>XXX</i> (the format) = <b>MDU, MUD, DMU, DUM, UMD, or UDM</b> <u>Note:</u> In the six potential values, “M” stands for machine name, “D” stands for recording start time, and “U” stands for user area
	Edit Machine Name	@0MNxxxx\r	Changes the machine name, where <i>xxxx</i> stands for the new machine name See <a href="#">Appendix &gt; Acceptable Characters for Serial Communication</a> for details on which characters can be used in the machine’s new name

Control Commands (Host → DN-900R)			
CATEGORY	CONTENTS	CODE	DESCRIPTION
Advanced Recording Options	Rename User Area	@0Uaxxxx\r	Edits the user area character string to be automatically included in recorded file names, where <i>xxxx</i> stands for a user area name of up to 32 characters See <a href="#">Appendix &gt; Acceptable Characters for Serial Communication</a> for details on which characters can be used in the user area's new name
	Add/Remove User Area in Recorded File Name Format	@0USNM\r	Sets recorded file names to automatically include or not include the user area name, where <i>NN</i> (the setting) = <b>00</b> (include) or <b>01</b> (don't include)
	Set Timer (by day of the week)	@0ShDWXXxxx xxxxHHMMhmm mUUUUU\r	Sets DN-900R to automatically start recording at a specific day and time: <ul style="list-style-type: none"> <li><i>XX</i> (the record timer setting number) = <b>01–30</b></li> <li><i>xxxxxxx</i> (the day or days of the week) = <b>SMTWTFS</b> and/or <b>_</b>; see note below for details</li> <li><i>HHMM</i> (the start time in hours and minutes) = <b>0000–2359</b></li> <li><i>hhmm</i> (the duration of the recording in hours and minutes) = <b>0000–2359</b></li> <li><i>UUUUU</i> stands for a user area name of up to 32 characters</li> </ul> <u>Note:</u> For the <i>xxxxxxx</i> variable, an entry must be made for all seven days of the week; if you would like to skip a day of the week, enter <b>_</b> instead of the first letter of the day name; for example, to set the recording only on Monday, Wednesday and Friday, enter <b>_M_W_F_</b> for <i>xxxxxxx</i> <u>Note:</u> If you want to set the recording to start every hour, enter <b>**</b> for the <i>HH</i> variable
	Set Timer (by specific date and time)	@0ShDTXXYYM MDDHHMMhh mmUUUUU\r	Sets DN-900R to automatically start recording at a specific date and time: <ul style="list-style-type: none"> <li><i>XX</i> (the record timer setting number) = <b>01–30</b></li> <li><i>YYMMDD</i> (the year, month, and date to start recording) = <b>130101–351231</b></li> <li><i>HHMM</i> (the start time in hours and minutes) = <b>0000–2359</b></li> <li><i>hhmm</i> (the duration of the recording in hours and minutes) = <b>0000–2359</b></li> <li><i>UUUUU</i> stands for a user area name of up to 32 characters</li> </ul> <u>Note:</u> To set the recording to occur annually, enter <b>**</b> for the <i>YY</i> variable; to set the recording to occur monthly, enter <b>**</b> for the <i>MM</i> variable
	Timer Off	@023TO\r	Turns the record timer(s) off
Delete Timer Setting	@0ShDLNM\r	Deletes the timer assigned to the timer setting number, where <i>NN</i> (the timer setting number) = <b>01–30</b>	

Control Commands (Host → DN-900R)			
CATEGORY	CONTENTS	CODE	DESCRIPTION
Advanced Recording Options	Delete All Timer Settings	@0ShAD\r	Delete all 30 record timer settings on DN-900R
	Set Archive Mode	@0ARXX\r	Sets whether/how DN-900R will archive recorded files, where XX (the setting) = <b>AT</b> (recorded files will be automatically archived as soon as they are finished recording), <b>SC</b> (recorded files will be archived according to a set schedule), or <b>01</b> (DN-900R will not archive any recorded files)
	Set Archive Timer (by day of the week)	@0asDWxxxxxx xhmm\r	Sets DN-900R to automatically archive previously recorded files at a recurring day and time: <ul style="list-style-type: none"> <li>xxxxxx (the day or days of the week that the archiving will take place) = <b>SMTWTFS</b> and/or _; see note below for details</li> <li>HHMM (the time that the archiving will take place in hours and minutes) = <b>0000–2359</b></li> </ul> <u>Note:</u> For the xxxxxx variable, an entry must be made for all seven days of the week; if you would like to skip a day of the week, enter _ instead of the first letter of the day name; for example, to set the recording only on Monday, Wednesday and Friday, enter <b>_M_W_F_</b> for the xxxxxx variable <u>Note:</u> If you want to set the recording to start every hour, enter <b>**</b> for the hh variable
	Set Archive Timer (by specific date and time)	@0asDTYYMM DDhmm\r	Sets DN-900R to automatically archive previously recorded files at a specific date and time, where YYMMDD (the year, month, and date to archive the files) = <b>130101–351231</b> and hhmm (the time to archive the files in hours and minutes) = <b>0000–2359</b> <u>Note:</u> If you want the archiving to recur annually, enter <b>**</b> for the YY variable; if you want the archiving to recur monthly, enter <b>**</b> for the MM variable
	Turn Clear After Arc. On/Off	@0CANM\r	Sets whether DN-900R automatically deletes recorded files after they are archived, where NN (the setting) = <b>00</b> (automatically delete after archiving) or <b>01</b> (don't automatically delete after archiving)
	Turn Auto Deletion On/Off	@0ADHH\r	Sets DN-900R to automatically delete archived files when the available memory on the current media source becomes limited to a specified amount of record time, where HH (the record time in hours) = <b>01, 03, 06, 12, or 24</b> ; enter <b>0F</b> for HH to deactivate the auto delete feature
	Reset Archive Settings	@0DEAC\r	Resets DN-900R's archive settings to their default values

Control Commands (Host → DN-900R)			
CATEGORY	CONTENTS	CODE	DESCRIPTION
Advanced Recording Options	Lower/Raise Input Level	@0ItXYNN\r	Adjusts the analog input volume level for either the left or right channel, where X = <b>L</b> (for the left channel) or <b>R</b> (for the right channel) and YNN (the volume adjustment in multiples of 0.1 dB) = <b>-20 – +20</b> For example, to increase the volume of the left channel by 1.5 dB, enter this code: @0ItL+15
	Set Recording Input Routing (Signal Pass Thru)	@0SpNN\r	Sets the recording input signal to be routed through the audio outputs, where NN (the setting) = <b>00</b> (route the recording input signal through the audio outputs) or <b>01</b> (don't route the recording input signal through the audio outputs)
	Change Rec Level Type	@0RIX\r	Changes the function of the record level knob on the front panel, where XX (the function) = <b>MA</b> (the record level knob will primarily adjust the volume level of the left and right channels; while shift is engaged, the record level knob will adjust the balance of the left and right channels) or <b>LR</b> (the record level knob will primarily adjust the volume level of the left channel; while shift is engaged, the record level knob will adjust the volume level of the right channel)
	Change Auto Level Control (ALC) Type	@0RLXX\r	Determines the function of the Auto Level Control (ALC) feature, where XX = <b>MA</b> (turns off ALC), <b>SE</b> (separate: ALC is applied to the left and right recording channels individually), or <b>MI</b> (mixed: ALC is applied equally to the left and right recording channels)
	Set XLR Voltage Level	@0LMXNN\r	Sets the XLR input channel to line or mic level, where X = <b>L</b> (for the left channel) or <b>R</b> (for the right channel) and NN (the voltage level) = <b>LN</b> (line) or <b>MC</b> (mic)
	Set XLR Mic Input Sensitivity	@0MsXNN\r	Adjust the mic input sensitivity for the XLR input, where X = <b>L</b> (for the left channel) or <b>R</b> (for the right channel) and NN (the mic input sensitivity level in -dBu) = <b>16–60</b>
	Turn Phantom Power On/Off	@0PhXY\r	Turns phantom power on or off for the XLR input, where X = <b>L</b> (for the left channel) or <b>R</b> (for the right channel) and YY = <b>00</b> (phantom power on) or <b>01</b> (phantom power off) <u>Note:</u> When the XLR input is set to line level, phantom power will be turned off automatically
Track Playback	Play	@02353\r	Plays the current track
	Pause	@02348\r	Pauses the current track
	Stop	@02354\r	Stops the current tracklist
	Hot Start Play	@0HPnn\r	Plays the track assigned the entered hot start number, where nn (the hot start number) = <b>01–20</b>

Control Commands (Host → DN-900R)			
CATEGORY	CONTENTS	CODE	DESCRIPTION
Track Playback	Set Playback Range	@0PrXX\r	Selects the tracks to be included in the current tracklist, where XX (the setting) = <b>AL</b> (all tracks in all folders on the current media source) or <b>FD</b> (only the tracks in the currently selected folder on the current media source)
	Set Playback Mode	@0PMXX\r	Sets how DN-900R will cycle through the current tracklist, where XX (the setting) = <b>SP</b> (play one track in the current tracklist and then stop playback) or <b>CN</b> (continuously play through the tracks in the current tracklist)
	Turn Repeat On/Off	@0RENM\r	Activates or deactivates the repeat feature, where NN = <b>00</b> (turn repeat on) or <b>01</b> (turn repeat off)
	Turn Random On/Off	@0RNnn\r	Activates or deactivates random playback for the current tracklist, where nn = <b>00</b> (turn random on) or <b>01</b> (turn random off)
	Turn Program List On/Off	@0PGNM\r	Activates playback of the pre-programmed tracklist, where NN = <b>00</b> (turn program list on) or <b>01</b> (turn program list off)
	Set Finish Mode	@0FMXX\r	Sets the playback status when the stop command is executed, where XX (the setting) = <b>ST</b> (stop: the current track will stop), <b>NT</b> (next track: the next track in the tracklist will be cued), <b>RC</b> (recue: DN-900R will skip to the point at which playback was previously started)
Advanced Playback Options	Set Fade In Time	@0FInn\r	Determines how long a track will fade in when playback is initiated, where nn (the length of the fade) = <b>00</b> (off/no fade in), <b>05</b> (500 milliseconds), <b>10</b> (1 second), or <b>30</b> (3 seconds)
	Set Fade Out Time	@0FOnn\r	Determines how long a track will fade out before playback ends, where nn (the length of the fade) = <b>00</b> (off/no fade out), <b>05</b> (500 milliseconds), <b>10</b> (1 second), or <b>30</b> (3 seconds)
	Set Playback Delay	@0sDnnn\r	Determines how long of a delay there will be after track playback is initiated, where nnn (the length of the delay) = <b>000</b> (off/no delay), <b>010</b> (100 milliseconds), <b>020</b> (200 milliseconds), or <b>030</b> (300 milliseconds)
	Set EOM Time	@0EDnn\r	Sets how long before the end of a track it will take before the “End of Message” icon displays, where nn (the length of time in seconds) = <b>00</b> , <b>05</b> , <b>10</b> , <b>15</b> , <b>20</b> , <b>30</b> , <b>60</b> , or <b>OF</b> (turns the EOM feature off)
	Autocue On/Off	@0ACNM\r	Sets the DN-900R to skip audio in the beginning of tracks that is below a specific volume threshold, where NN (the volume threshold in -dB) = <b>36</b> , <b>42</b> , or <b>48</b> ; if <b>00</b> is entered, the autocue function will be deactivated

Control Commands (Host → DN-900R)			
CATEGORY	CONTENTS	CODE	DESCRIPTION
Advanced Playback Options	Set Timer (by day of the week)	@0TPDWXXxxx xxxxhhmmFFFF Fr	<p>Sets DN-900R to automatically start playing a track at a specific day and time:</p> <ul style="list-style-type: none"> <li>• XX (the playback timer setting number) = <b>01–30</b></li> <li>• xxxxxx (the day or days of the week) = <b>SMTWTFS</b> and/or <b>_</b>; see note below for more details</li> <li>• hhmm (the start time in hours and minutes) = <b>0000–2359</b></li> <li>• FFFFF stands for the name of the track file (absolute path required)</li> </ul> <p><u>Note:</u> For the xxxxxx variable, an entry must be made for all seven days of the week; if you would like to skip a day of the week, enter <b>_</b> instead of the first letter of the day name; for example, to set track playback only on Monday, Wednesday and Friday, enter <b>_M_W_F_</b> for xxxxxx</p> <p><u>Note:</u> If you want to set track playback to start every hour, enter <b>**</b> for the <i>HH</i> variable</p> <p>See <a href="#">Appendix &gt; Entering the Absolute Path for Folder and File Names</a> for details on the requirements for entering absolute paths</p>
	Set Timer (by date and time)	@0TPDXTXYYM MDDhhmmFFF FFr	<p>Sets DN-900R to automatically start playing a track at a specific date and time:</p> <ul style="list-style-type: none"> <li>• XX (the playback timer setting number) = <b>01–30</b></li> <li>• YYMMDD (the year, month, and date to start playback) = <b>130101–351231</b></li> <li>• hhmm (the start time in hours and minutes) = <b>0000–2359</b></li> <li>• FFFFF stands for the name of the track file (absolute path required)</li> </ul> <p><u>Note:</u> To set track playback to occur annually, enter <b>**</b> for the <i>YY</i> variable; to set track playback to occur monthly, enter <b>**</b> for the <i>MM</i> variable</p> <p>See <a href="#">Appendix &gt; Entering the Absolute Path for Folder and File Names</a> for details on the requirements for entering absolute paths</p>
	Set Timer Priority	@0tpNNr	<p>Determines the conditions under which the playback timer will start playback, where <i>NN</i> = <b>00</b> (the scheduled playback will start as long as recording is not in progress) or <b>01</b> (the scheduled playback will only start if DN-900R is paused, stopped, or in standby)</p>
	Delete Timer Setting	@0TPDLNNr	<p>Deletes the timer assigned to the timer setting number, where <i>NN</i> (the playback timer setting number) = <b>01–30</b></p>
	Delete All Timer Settings	@0TPADr	<p>Deletes all 30 playback timer settings on DN-900R</p>
Track Selection	Restart/Previous Track	@02333r	<p>Restarts the current track or skips to the previous track in the tracklist</p>

Control Commands (Host → DN-900R)			
CATEGORY	CONTENTS	CODE	DESCRIPTION
Track Selection	Next Track	@02332\r	Skips to the next track in the tracklist
	Hot Start Cue Up	@0HCnn\r	Cues the track assigned the entered hot start number, where <i>nn</i> (the hot start number) = <b>01–20</b>
	Select Track Number (3 digit)	@0TRnnn\r	Selects the track corresponding to the entered file number, where <i>nnn</i> (the track file number) = <b>001–999</b>
	Select Track Number (4 digit)	@0Trnnnn\r	Selects the track corresponding to the entered file number, where <i>nnnn</i> (the track file number) = <b>0001–2000</b>
	Select Folder Number	@0Sfnnnn\r	Selects the folder corresponding to the entered number, where <i>nnnn</i> (the folder number) = <b>0001–2000</b>
	Set File Order	@0FRXX\r	Sets whether files in media source folders are ordered alphabetically or by date, where <i>XX</i> (the setting) = <b>AL</b> (alphabetically) or <b>DA</b> (date)
	Load Program List	@0PIXXXX\r	Loads the program list, where <i>XXXX</i> stands for the program list's file name (absolute path required) See <a href="#">Appendix &gt; Entering the Absolute Path for Folder and File Names</a> for details on the requirements for entering absolute paths
	Add to Program List	@0PinnNNN\r	Adds the track to the currently loaded program list, where <i>nn</i> (the desired position in the program list) = <b>01–99</b> , and <i>NNN</i> (the track file number) = <b>0001–2000</b>
	Take Off Program List	@0Pmnn\r	Removes a track from its position in the currently loaded program list, where <i>nn</i> (the position in the program list) = <b>01–99</b>
Save Program List	@0PsXXXX\r	Save the currently loaded program list as a new file, where <i>XXXX</i> stands for a file name of up to 252 characters (absolute path required) See <a href="#">Appendix &gt; Acceptable Characters for Serial Communication</a> for details on which characters can be used in the name of the program list file See <a href="#">Appendix &gt; Entering the Absolute Path for Folder and File Names</a> for details on the requirements for entering absolute paths	
Track Searching	Rewind (cyclic)	@02350\r	Rewinds the current track; each entry of the command cycles through the rewind speeds (2x, 10x, 50x, 100x, and 200x)
	Rewind (specific)	@02350n\r	Rewinds the current track at a specific speed, where <i>n</i> (the speed) = <b>1</b> (for 2x), <b>2</b> (for 10x), <b>3</b> (for 50x), <b>4</b> (for 100x), or <b>5</b> (for 200x)
	Skip Back	@023SB\r	Rewinds the current track by a set number of seconds

Control Commands (Host → DN-900R)			
CATEGORY	CONTENTS	CODE	DESCRIPTION
<b>Track Searching</b>	Set Skip Back Time	@0SBNNM\r	Sets the number of seconds that a track will rewind when Skip Back is executed, where <i>NNN</i> (the number of seconds in multiples of 0.1) = <b>005–600</b> (0.5 second – 60 seconds)
	Fast Forward (cyclic)	@02352\r	Fast forwards the current track; each entry of the command cycles through the fast forward speeds (2x, 10x, 50x, 100x, and 200x)
	Fast Forward (specific)	@02352n\r	Fast forwards the current track at a specific speed, where <i>n</i> (the speed) = <b>1</b> (for 2x), <b>2</b> (for 10x), <b>3</b> (for 50x), <b>4</b> (for 100x) or <b>5</b> (for 200x)
	Set Search Audibility	@0sMXX\r	Determines whether audio will be heard while fast-forwarding or rewinding at the 2x speed, where <i>XX</i> = <b>NO</b> (audio will be heard) or <b>SL</b> (audio will not be heard)
	Activate Frame Mode	@0frON\r	Enters DN-900R in frame search mode; after entering frame search mode, the current track will be paused, and the track will be audible while skipping frame units
	Frame Forward	@0fr00\r	Skips forward one frame unit in the current track
	Frame Reverse	@0fr01\r	Skips back one frame unit in the current track
	Skip Back to Mark	@023M-\r	Skips back to the mark prior to the current track's playback position
	Skip Ahead to Mark	@023M+\r	Skips ahead to the mark after the current track's playback position
	Cue	@023CU\r	Skips to the track time position from which playback was last started and pauses the track
<b>Hot Start Assignment</b>	Load Hotlist	@0HLXXXX\r	Loads a hotlist file, where <i>XXXX</i> stands for the hotlist file name
	Assign Hot Start Number (with 3-digit track file number)	@0HSnnNNM\r	Assigns the track to the hot start number in the currently loaded hotlist, where <i>nn</i> (the hot start number) = <b>01–20</b> and <i>NNN</i> (the track file number) = <b>001–999</b> <b>Note:</b> Enter <b>000</b> for <i>NNN</i> to cancel the hot start number assignment
	Assign Hot Start Number (with 4-digit track file number)	@hsnnNNNN\r	Assigns the track to the hot start number in the currently loaded hotlist, where <i>nn</i> (the hot start number) = <b>01–20</b> and <i>NNNN</i> (the track file number) = <b>0001–2000</b> <b>Note:</b> Enter <b>0000</b> for <i>NNNN</i> to cancel the hot start number assignment
	Assign Hot Start Number (with file name)	@0HsnnXXXX\r	Assigns the track to the hot start number in the currently loaded hotlist, where <i>nn</i> (the hot start number) = <b>01–20</b> and <i>XXXX</i> = the track file name (absolute path required) See <a href="#">Appendix &gt; Entering the Absolute Path for Folder and File Names</a> for details on the requirements for entering absolute paths



Control Commands (Host → DN-900R)			
CATEGORY	CONTENTS	CODE	DESCRIPTION
Hot Start Assignment	Save Hotlists	@0HSSR\r	Saves all DN-900R's hotlist files to the currently selected media source
	Divide	@023Dd\r	Splits into two files the current track or recording at the current playback/recording position
Editing and Organizing Tracks/ Recordings	Combine	@023CBnnnn\r	Combines the currently selected track with another track on the media source, where <i>nnnn</i> (the file number for the track to be combined with the current track) = <b>0001–2000</b>
	Delete Marks	@023Me\r	Delete all marks in the current track
	Pitch/Speed Editing On/Off	@02337XX\r	Enables or disables pitch/speed editing, where <i>XX</i> = <b>ON</b> (enable) or <b>OF</b> (disable)
	Lock/Unlock Master Key	@0KYNN\r	Determines whether using the pitch-control edits both the pitch and speed or whether the pitch is locked and only the speed can be edited, where <i>NN</i> = <b>00</b> (lock the pitch) or <b>01</b> (unlock the pitch)
	Pitch Up	@02338\r	Transposes the pitch/speed of the current track or recording by +0.1%
	Pitch Down	@02339\r	Transposes the pitch/speed of the current track or recording by -0.1%
	Adjust Pitch/Speed	@0PTSSXXXX\r	Enters a specific pitch/speed transposition for the current track/recording, where <i>SS</i> (the pitch-control on/off setting) = <b>ON</b> or <b>OF</b> and <i>XXXX</i> (the pitch/speed value as a percentage of the default pitch/speed between -16% and 16%) = <b>1160–0160</b> <b>Note:</b> In the <i>XXXX</i> variable, a first digit of 0 makes the percentage positive, a first digit of 1 makes the percentage negative, and the last three digits are the pitch/speed value in multiples of 0.1% For example, to adjust the pitch/speed of the current track/recording by +14.5%, enter this code: @0PTON0145; to adjust the pitch/speed of the current track/recording by -8.0%, enter this code: @0PTON1080
	Undo	@023UD\r	Undoes the prior edit
	Create Folder	@0MFxxxx\r	Adds a new folder to the currently selected media source, where <i>xxxx</i> stands for the name of the new folder, with a maximum length requirement of 252 characters (absolute path not required) See <a href="#">Appendix &gt; Acceptable Characters for Serial Communication</a> for details on which characters can be used in the name of the new folder
	Delete Folder	@0DRxxxx\r	Deletes a folder from the currently selected media source, where <i>xxxx</i> stands for the name of the folder to be deleted (absolute path not required)

Control Commands (Host → DN-900R)			
CATEGORY	CONTENTS	CODE	DESCRIPTION
Editing and Organizing Tracks/ Recordings	Rename Folder	@0RFxxx:XXX\r	Renames a folder on the currently selected media source, where xxx stands for the current name of the folder (absolute path required) and XXX stands for the new folder name (absolute path not required) See <a href="#">Appendix &gt; Acceptable Characters for Serial Communication</a> for details on which characters can be used in the folder's new name See <a href="#">Appendix &gt; Entering the Absolute Path for Folder and File Names</a> for details on the requirements for entering absolute paths
	Move File (3 Digit)	@0MvnnnXXX\r	Moves the file to the folder, where nnn (the file number) = <b>001–999</b> and XXX stands for the folder name (absolute path required) See <a href="#">Appendix &gt; Entering the Absolute Path for Folder and File Names</a> for details on the requirements for entering absolute paths
	Move File (4 Digit)	@0MvnnnnXXX\r	Moves the file to the folder, where nnn (the file number) = <b>0001–2000</b> and XXXX stands for the folder name (absolute path required) See <a href="#">Appendix &gt; Entering the Absolute Path for Folder and File Names</a> for details on the requirements for entering absolute paths
	Copy File (3 Digit)	@0CYnnnXXX\r	Copies the file to the folder, where nnn (the file number) = <b>001–999</b> and XXX stands for the folder name (absolute path required) See <a href="#">Appendix &gt; Entering the Absolute Path for Folder and File Names</a> for details on the requirements for entering absolute paths
	Copy File (4 Digit)	@0CYnnnnXXX\r	Copies the file to the folder, where nnnn (the file number) = <b>0001–2000</b> and XXXX stands for the folder name (absolute path required) See <a href="#">Appendix &gt; Entering the Absolute Path for Folder and File Names</a> for details on the requirements for entering absolute paths
	Cancel Move/Copy	@0CNAL\r	Cancels the in-progress moving or copying of a file
	Delete File (3 digit)	@023Tennn\r	Deletes the file, where nnn (the file number) = <b>001–999</b>
	Delete File (4 digit)	@023Tennnn\r	Deletes the file, where nnnn (the file number) = <b>0001–2000</b>
	Rename File (3 digit)	@0RNnnnXXX\r	Renames the file, where nnn (the file number) = <b>001–999</b> and XXX stands for a file name no longer than 251 characters (absolute path not required) See <a href="#">Appendix &gt; Acceptable Characters for Serial Communication</a> for details on which characters can be used in the file's new name

Control Commands (Host → DN-900R)			
CATEGORY	CONTENTS	CODE	DESCRIPTION
Editing and Organizing Tracks/ Recordings	Rename File (4 digit)	@0RNnnnnXXX X\r	Renames the file, where <i>nnnn</i> (the file number) = <b>0001–2000</b> and <i>XXXX</i> stands for a file name no longer than 251 characters (absolute path not required) See <a href="#">Appendix &gt; Acceptable Characters for Serial Communication</a> for details on which characters can be used in the file's new name
Advanced Audio Settings	Lower/Raise Output Level	@0OtXYNN\r	Adjusts the analog output volume level for either the left or right channel, where <i>X</i> = <b>L</b> (for the left channel) or <b>R</b> (for the right channel) and <i>YNN</i> (the volume adjustment in multiples of 0.1 dB) = <b>-20 – +20</b> For example, to increase the volume of the left channel by 1.5 dB, enter this code: @0tL+15
	Set Audio Output Rate	@0dFXX\r	Sets the audio output sample rate, where <i>XX</i> = <b>AT</b> (automatic: sample rate will match that of the audio input source/file), <b>44</b> (sample rate will be set to 44.1 kHz), <b>48</b> (sample rate will be set to 48 kHz), <b>EX</b> (sample rate will be set using an external clock for the digital signal)
	Switch to Mono	@0MONN\r	Sets the audio output to mono-summed or to match the input source, where <i>NN</i> = <b>00</b> (mono) or <b>01</b> (match the input source)
	Set Reference Level	@0FrNN\r	Adjusts the reference level, where <i>NN</i> = <b>24</b> (+24 dBu for XLR / +10 dBv for RCA), <b>20</b> (+20 dBu for XLR / +6 dBv for RCA), or <b>18</b> (+18 dBu for XLR / +4 dBv for RCA)
Network Settings	Set Archive Server IP	@0Aixxxx\r	Sets the IP address for network archiving, where <i>xxxx</i> stands for the IP address (omitting periods)
	Create FTP (Archive) Server User Name	@0Auxxxx\r	Creates a user name for the archive network, where <i>xxxx</i> stands for a user name of up to 255 characters See <a href="#">Appendix &gt; Acceptable Characters for Serial Communication</a> for details on which characters can be used in the user name
	Create FTP (Archive) Server Password	@0Apxxxx\r	Creates a password for the archive network, where <i>xxxx</i> stands for a password of up to 12 characters See <a href="#">Appendix &gt; Acceptable Characters for Serial Communication</a> for details on which characters can be used in the password
	Set FTP (Archive) Server Folder	@0Aoxxxx\r	Sets the network folder to which archived files will be automatically saved, where <i>xxxx</i> stands for the folder name (absolute path required)
	Assign IP Address	@0lpxxxx\r	Assigns a static IP address to DN-900R, where <i>xxxx</i> stands for the IP address (omitting periods); enter <b>AUTO00000000</b> for the <i>xxxx</i> variable to set DN-900R to be automatically assigned its IP address

Control Commands (Host → DN-900R)			
CATEGORY	CONTENTS	CODE	DESCRIPTION
Network Settings	Set Subnet Mask	@0SMxxxx\r	If a static IP address is assigned to DN-900R, sets the subnet mask, where xxxx stands for the subnet mask number (omitting any periods) <u>Note:</u> DN-900R will automatically reboot after this command is executed
	Set Gateway IP	@0GWxxxx\r	If a static IP address is assigned to DN-900R, sets the Gateway IP address, where xxxx stands for the IP address (omitting periods) <u>Note:</u> DN-900R will automatically reboot after this command is executed
	Set DNS Server Address	@0DNxxxx\r	If a static IP address is assigned to DN-900R, sets the DNS server address, where xxxx stands for the address number (omitting periods) DN-900R will automatically reboot after this command is executed
	Set NTP Server Address	@0NPxxxx\r	Sets the NTP server address, where xxxx stands for the address number (omitting periods); to turn NTP off, enter <b>DISABLE00000</b> for the xxxx variable
	Enter NTP Cycle Time	@0NChhmm\r	Enters the NTP cycle time, where hhmm (the cycle time in hours and minutes) = <b>0015–2400</b> <u>Note:</u> The cycle time can only be entered in fifteen minute increments
	Set Syslog Server Address	@0Slxxxx\r	Sets the syslog server address, where xxxx stands for the server address (omitting periods); to turn syslog off, enter <b>DISABLE00000</b> for the xxxx variable
	Set IP Control Port Number	@0lpNNNNM\r	Sets the IP control port number, where NNNNN (the number) = <b>00000–65535</b> <u>Note:</u> DN-900R will automatically reboot after this command is executed
	Authentication On/Off	@0laNM\r	Sets whether password authentication is required for IP control, where NN (the setting) = <b>00</b> (required) or <b>01</b> (not required) <u>Note:</u> DN-900R will automatically reboot after this command is executed
	Create Operator Password	@0OPxxxx\r	Sets the operator password for the web remote control, where xxxx stands for a password of 6–12 characters See <a href="#">Appendix &gt; Acceptable Characters for Serial Communication</a> for details on which characters can be used in the password
	Create Observer Password	@0Opxxxx\r	Sets the observer password for the web remote control, where xxxx stands for a password of 6–12 characters See <a href="#">Appendix &gt; Acceptable Characters for Serial Communication</a> for details on which characters can be used in the password
Logout of IP Control	@0LO\r	Logout of web remote control	

Control Commands (Host → DN-900R)			
CATEGORY	CONTENTS	CODE	DESCRIPTION
<b>Network Settings</b>	Change Network Standby Setting	@0NsNN\r	Sets whether DN-900R can be controlled from the network while it is in standby, where <i>NN</i> (the setting) = <b>00</b> (can be controlled) or <b>01</b> (can't be controlled)
<b>Clock/Display Settings</b>	Set Date and Time	@0DtYYMMDD hhmm\r	Sets the date and time on DN-900R, where <i>YYMMDD</i> (the year, month, and day) = <b>130101–351231</b> and <i>hhmm</i> (the time in hours:minutes) = <b>0000–2359</b>
	Set Time Zone	@0TZxHHMM	Sets the time zone on DN-900R, where <i>x</i> (the offset direction) and <i>HHMM</i> (the offset amount in hours and minutes) = <b>-1200 – +1400</b> ; <b>+0000</b> is GMT <u>Note</u> : the offset amount can only be adjusted in fifteen minute increments
	Observe/Don't Observe Daylight Savings	@0dSNN\r	Determines whether DN-900R will observe daylight savings in tracking the time, where <i>NN</i> = <b>00</b> (observe daylight savings) or <b>01</b> (don't observe daylight savings)
	Adjust Daylight Savings Time Offset	@0dohhmm\r	Adjust the daylight savings time offset, where <i>hhmm</i> (hours:minutes) = <b>0000–0600</b> <u>Note</u> : this setting can only be adjusted in fifteen minute increments
	Set Daylight Savings Start Date	@0dsMMDDhh mm\r	Sets the date and time when daylight savings will be applied, where <i>MMDD</i> (the month and day) = <b>0101–1231</b> and <i>hhmm</i> (the time in hours and minutes) = <b>0000–2359</b>
	Set Daylight Savings End Date	@0deMMDDhh mm\r	Sets the date and time when daylight savings will end, where <i>MMDD</i> (the month and day) = <b>0101–1231</b> and <i>hhmm</i> (the time in hours and minutes) = <b>0000–2359</b>
	Set Time Format	@0TDXXX\r	Determines how the time will be shown on DN-900R's display screen, where <i>XXX</i> (the time format) = <b>HMS</b> (shown in hours:minutes:seconds) or <b>MSF</b> (shown in minutes:seconds:frames)
	Set Time Notation	@0TFNN\r	Adjust the time notation setting for the display screen, where <i>NN</i> (the setting) = <b>12</b> (12-hour AM/PM clock) or <b>24</b> (24-hour clock)
	Set Date Format	@0DFXX\r	Determines how the date will be shown on the display screen, where <i>XX</i> (the date format) = <b>MD</b> (month/day/year), <b>DM</b> (day/month/year), or <b>YM</b> (year/month/day)
	Screen Saver On/Off	@0SsNN\r	Activates or deactivates the screen saver that appears on the display screen after 30 minutes of inactivity, where <i>NN</i> = <b>00</b> (turn screen saver on) or <b>01</b> (turn screen saver off)
	Dimmer On/Off	@0DMNN\r	Activates or deactivates the dimmer for the Display screen and LED's, where <i>NN</i> = <b>00</b> (turn dimmer on) or <b>01</b> (turn dimmer off)

Control Commands (Host → DN-900R)			
CATEGORY	CONTENTS	CODE	DESCRIPTION
Clock/Display Settings	Set Display Brightness	@0DDNMr	Adjusts the brightness of the Display screen, where <i>NN</i> (the brightness setting) = <b>00</b> (100%), <b>01</b> (75%), <b>02</b> (50%), <b>03</b> (25%), or <b>04</b> (0%)
	Set LED Brightness	@0LDNMr	Adjusts the brightness of the LEDs, where <i>NN</i> (the brightness setting) = <b>00</b> (100%), <b>01</b> (75%), <b>02</b> (50%), or <b>03</b> (25%)
	Set Contrast	@0BNnnr	Adjusts the contrast of the display screen, where <i>nn</i> (the contrast setting) = <b>01–05</b>
	Set Display Language	@0LNXXr	Changes the language for folder and file names shown on the display screen, where <i>XX</i> (the language) = <b>US</b> (English) or <b>JP</b> (Japanese) <u>Note</u> : Executing this command will cause DN-900R to reboot
Other Settings	Create Admin Password	@0PDxxxxr	Sets the admin password, where <i>xxxx</i> = a password between 6 and 12 characters See <a href="#">Appendix &gt; Acceptable Characters for Serial Communication</a> for details on which characters can be used in the admin password
	Format Media Drive	@023FOMATr	Formats the currently selected media source
	Shift	@0SmXXr	Engages the shift control in order to provide access to secondary functions of DN-900R's other controls, where <i>XX</i> = <b>MO</b> (momentary: shift will only be engaged while the next control is used) or <b>LK</b> (lock: shift will remain engaged until it is manually disengaged)
	Key Lock	@023KLr	Locks the front panel buttons
	Key Unlock	@023KUr	Unlocks the front panel buttons
	Lock Transport Buttons	@023KSr	Locks only the transport buttons on the front panel ( <b>Stop, Play, Pause, Rec</b> )
	Turn Auto Reboot On/Off	@0ArNM	Determines whether DN-900R will automatically reboot when the main processor freezes, where <i>NN</i> = <b>00</b> (turn auto reboot on) or <b>01</b> (turn auto reboot off)
	Change Language	@0KBXXr	Sets the language for the keyboard connected to the USB keyboard input, where <i>XX</i> (the language) = <b>US</b> (American English), <b>UK</b> (British English), <b>FR</b> (French), <b>GE</b> (German), <b>IT</b> (Italian), <b>SP</b> (Spanish), <b>NE</b> (Dutch), <b>SW</b> (Swedish), or <b>JP</b> (Japanese)
	Select Preset	@0PSNM	Selects and applies a settings preset, where <i>NN</i> (the settings preset number) = <b>01, 02, or 03</b>
	Title Preset	@0PNn:xxxxr	Titles the settings preset, where <i>n</i> (the settings preset number) = <b>1, 2, or 3</b> , and <i>xxxx</i> (the title) stands for a desired name of up to 32 characters in length See <a href="#">Appendix &gt; Acceptable Characters for Serial Communication</a> for details on which characters can be used in the name of the settings preset

<b>Control Commands (Host → DN-900R)</b>			
<b>CATEGORY</b>	<b>CONTENTS</b>	<b>CODE</b>	<b>DESCRIPTION</b>
<b>Other Settings</b>	Load a Settings Preset	@0PVLD\r	Loads the settings preset file in the root folder of the currently selected media source
	Save Settings as a Preset	@0PVSA\r	Saves the current combination of settings into a preset file on the root folder of the currently selected media source
	Reset System Settings	@0DESY\r	Resets all system settings to their factory default values
	Reset Settings	@0DEFL\r	Resets all preset settings to their default values

## Status Request Command Codes/Status Information Codes

Use the status request command codes below to check on the status of your DN-900R. In response, DN-900R will send a corresponding status information code.

In cases where the status request command code includes a variable, the variable is indicated in *italicized font* and the potential values are indicated in **bold font**.

Status Request Commands (Host → DN-900R)		Status Information (DN-900R → Host)		DESCRIPTION
REQUEST	CODE	ANSWER	CODE	
<b>Admin Login</b>	@0?LIxxx\r	Success	@0LlOK\r	The entered password was correct, where <i>xxxx</i> stands for the password; you are now logged in and able to execute serial commands
		Failed	@0LING\r	The entered password was incorrect, where <i>xxxx</i> stands for the password; you will need to try logging in again in order to execute serial commands
<b>Power Status</b>	@0?PW\r	On	@0PW00\r	The power is on
		Standby	@0PW01\r	DN-900R is in standby
		Network Standby	@0PW02\r	DN-900R is in network standby
<b>Power On Mode</b>	@0?PO\r	Resume playback	@0PORM\r	DN-900R is set to resume playback of the last played track when powered on
		Play first track	@0POPF\r	DN-900R is set to play the first track in the last used folder when powered on
		Stop	@0POST\r	DN-900R is set to stop playback when powered on
		Record	@0PORE\r	DN-900R is set to begin recording to the last selected media source when powered on
<b>Source Status</b>	@0?MM\r	Selected media source	@0MMXX\r	The currently selected media source, where <i>XX</i> (the selected media source) = <b>US</b> (USB), <b>S1</b> (SD Card 1), <b>S2</b> (SD Card 2), or <b>NE</b> (the network)
<b>Media Status</b>	@0?CD\r	Card in	@0CDCI\r	There is an SD card in one of the SD slots
		No card	@0CDNC\r	There is no SD card
		Card error	@0CDCE\r	There is an error with the SD card
		Unformatted	@0CDUF\r	The currently selected media source is unformatted
		Write-protected	@0CDWP\r	The currently selected media source is write-protected
		SD door open	@0CDDO\r	The SD slot door is open



Status Request Commands (Host → DN-900R)		Status Information (DN-900R → Host)		DESCRIPTION
REQUEST	CODE	ANSWER	CODE	
<b>Media Size</b>	@0?SF\r	Total capacity of the media drive	@0FEmmXXXX\r	The total capacity of the currently selected media source, where <i>mm</i> (the media source) = <b>S1</b> (SD Card 1), <b>S2</b> (SD Card 2), or <b>US</b> (USB) and <i>XXXX</i> stands for the capacity
<b>Media Free Space</b>	@0?FE\r	SD Card 1	@0FES1XXXX	The amount of free space left on SD Card 1, where <i>XXXX</i> stands for the free space left
		SD Card 2	@0FES2XXXX	The amount of free space left on SD Card 2, where <i>XXXX</i> stands for the free space left
		USB drive	@0FEUSXXXX	The amount of free space left on the USB drive, where <i>XXXX</i> stands for the free space left
<b>Device Status</b>	@0?ST\r	Playing	@0STPL\r	The current track is playing
		A-B repeat	@0STAB\r	The current track is playing (with the A-B repeat feature activated)
		Paused	@0STPP\r	The current track is paused
		Repeat paused	@0STPR\r	The current track is paused (with the repeat feature activated)
		Stopped	@0STST\r	The current tracklist is stopped
		Cued	@0STCU\r	A track is currently cued
		Autocued	@0STAC\r	A track is currently autocued
		Rewinding	@0STRW\r	The current track is rewinding
		Fast forwarding	@0STFF\r	The current track is fast forwarding
		A-B repeat	@0STAB\r	The A-B repeat feature is activated on the current track
		Loading	@0STLD\r	DN-900R is currently loading
		Busy	@0STBY\r	DN-900R is currently busy
		File list open	@0STFL\r	The file list is currently open
		Menu open	@0STED\r	The menu settings are currently open
		Timer standby	@0STSH\r	Pre-scheduled recording or playback is currently in progress
Error	@0STER\r	There is an operation error		
<b>Search Speed</b>	@0?SP\r	Speed value	@0SPXnnn\r	The direction in and speed at which the track is searching, where <i>X</i> (the direction) = <b>R</b> (rewinding) or <b>F</b> (fast-forwarding) and <i>nnn</i> (the speed) = <b>002</b> (2x), <b>010</b> (10x), <b>050</b> (50x), <b>100</b> (100x), or <b>200</b> (200x)
<b>Recording Audio Input</b>	@0?IN\r	Unbalanced	@0INUB\r	The recording audio source is set to the RCA inputs

Status Request Commands (Host → DN-900R)		Status Information (DN-900R → Host)		DESCRIPTION
REQUEST	CODE	ANSWER	CODE	
Recording Audio Input	@0?IN\r	Balanced	@0INBA\r	The recording audio source is set to the analog XLR inputs
		Coaxial	@0INDI\r	The recording audio source is set to the coaxial input
		AES/EBU	@0INDB\r	The recording audio source is set to the AES/EBU input
One Touch Recording Status	@0?OR\r	On	@0OR00\r	One Touch Recording is turned on
		Off	@0OR01\r	One Touch Recording is turned off
Pre-Record Setting	@0?PR\r	Off	@0PR\r	The pre-record timer is turned off
		On	@0PRnS\r	The pre-record timer is turned on, where <i>n</i> (the length of the timer in seconds) = <b>1–5</b>
Recording Folder	@0?Rf\r	Current	@0RfCU\r	DN-900R is set to save new recordings to the currently selected folder
		Fixed	@0RfXXXX\r	DN-900R is set to save new recordings to a specific folder, where XXXX stands for the name of the folder
Remaining Record Time	@0?RT\r	Amount of available recording time	@0RThhhmmss\r	The estimated amount of time that DN-900R can record to the currently selected media source before the media source runs out of space, where <i>hhmmss</i> (the amount of time in hours, minutes, and seconds) = <b>0000001–9995959</b>
Recording Volume	@0?RV\r	The recording volume	@0RVLLRR\r	The recording volume, where <i>LL</i> stands for the left channel volume rounded to the nearest one and <i>RR</i> stands for the right channel volume rounded to the nearest one
Recording Volume Type	@0?VI\r	Fixed	@0VIFX\r	The recording input volume is fixed at 0 dB
		Variable	@0VIVA\r	The recording input volume can be adjusted
Record Monitor Setting	@0?Rm\r	On	@0Rm00\r	The record monitor feature is currently set to on
		Off	@0Rm01\r	The record monitor feature is currently set to off
Auto Track Time	@0?AT\r	Auto track time interval setting	@0ATHhmm\r	The time interval in which DN-900R is set to split in-progress recordings when the auto-track feature is activated, where <i>hhmm</i> (the length of time in hours and minutes) = <b>0001, 0005, 0010, 0015, 0030, 0100, 0200, 0600, 0800, 1200, or 2400</b> ; DN-900R will answer with <b>0000</b> for the variable if the auto track feature is deactivated

Status Request Commands (Host → DN-900R)		Status Information (DN-900R → Host)		DESCRIPTION
REQUEST	CODE	ANSWER	CODE	
<b>Record Level Type</b>	@0?RI\r	Master volume	@0RIMA\r	The record level knob is set to primarily adjust the volume of the left and right channels; while shift is engaged, the knob will adjust the balance of the left and right channels
		L/R balance	@0RILR\r	The record level knob is set to primarily adjust the volume of the left channel; while shift is engaged, the knob will adjust the volume of the right channel
<b>Auto Level Control (ALC) Type</b>	@0?RL\r	Off	@0RLMA\r	ALC is turned off
<b>Auto Level Control (ALC) Type</b>	@0?RL\r	Separate	@0RLSE\r	ALC is turned on and set to be applied individually to the left and right recording channels
		Mixed	@0RLMI\r	ALC is turned on and set to be applied equally to the left and right recording channels
<b>Dual Recording Status</b>	@0?dR\r	Off	@0dROF\r	Dual recording is turned off
		SD1	@0dRS1\r	Dual recording is turned on and SD Card 1 is set as the backup media
		SD2	@0dRS2\r	Dual recording is turned on and SD Card 2 is set as the backup media
		USB	@0dRUS\r	Dual recording is turned on and USB is set as the backup media
<b>Relay Recording Status</b>	@0?rR\r	Off	@0rROF\r	Relay recording is turned off
		SD1	@0rRS1\r	Relay recording is turned on and SD Card 1 is set as the backup media
		SD2	@0rRS2\r	Relay recording is turned on and SD Card 2 is set as the backup media
		USB	@0rRUS\r	Relay recording is turned on and USB is set as the backup media
<b>Archive Setting</b>	@0?AR\r	Auto	@0ARAT\r	Recorded files are set to be automatically archived as soon as they are finished recording
		Timed	@0ARSC\r	Recorded files are set to be archived on schedule with the archive timer
<b>Archive Setting</b>	@0?AR\r	Off	@0AR01\r	The archive feature is deactivated
<b>Clear After Arc. Setting</b>	@0?CA\r	On	@0CA00\r	DN-900R is set to automatically delete recorded files after they are archived
		Off	@0CA01\r	DN-900R is not set to automatically delete recorded files after they are archived

Status Request Commands (Host → DN-900R)		Status Information (DN-900R → Host)		DESCRIPTION
REQUEST	CODE	ANSWER	CODE	
Auto Deletion Setting	@0?AD\r	Off	@0ADOF\r	DN-900R is not set to automatically delete archived files when the available memory on the current media source becomes limited to a specified amount of record time
		On	@0ADHH\r	DN-900R is set to automatically delete archived files when the available memory on the current media source becomes limited to a specified amount of record time, where <i>HH</i> (the record time in hours) = <b>01, 03, 06, 12, or 24</b> ; enter <b>OF</b> for <i>HH</i> to deactivate the auto delete feature
Record Channel Setting	@0?CH\r	Stereo	@0CHST\r	DN-900R is set to record stereo files
		Mono (L)	@0CHML\r	DN-900R is set to record left-channel mono files
		Mono mixed	@0CHMX\r	DN-900R is set to record mono-mixed files
Recording File Format	@0?AF\r	PCM	@0AFPMnn\r	The file format for recordings is set to PCM, where <i>nn</i> stands for the bit rate
		MP3	@0AFM3nnn\r	The file format for recordings is set to MP3, where <i>nnn</i> (the bit rate in Kbps) = <b>064, 128, 192, 256, or 320</b>
Recording Sample Rate	@0FSN\r	Current sample rate setting	@0FSN\r	The current setting for the recording sample rate, where <i>NN</i> (the sample rate) = <b>44, 48, 96 or EX</b> (for the AES/EBU input)
File Name Format	@0?Ff\r	MN_DT_UA	@0FfMDU\r	The file name format for recorded files is set to include the machine name first, then the date, then the user area (if applicable)
		MN_UA_DT	@0FfMUD\r	The file name format for recorded files is set to include the machine name first, then the user area (if applicable), then the date
		DT_MN_UA	@0FfDMU\r	The file name format for recorded files is set to include the date first, then the machine name, then the user area (if applicable)
		DT_UA_MN	@0FfDUM\r	The file name format for recorded files is set to include date first, then the user area (if applicable), then the machine name
		UA_MN_DT	@0FfUMD\r	The file name format for recorded files is set to include the user area first (if applicable), then the machine name, then the date

Status Request Commands (Host → DN-900R)		Status Information (DN-900R → Host)		DESCRIPTION
REQUEST	CODE	ANSWER	CODE	
<b>File Name Format</b>	@0?Ff\r	UA_DT_MN	@0FfUDM\r	The file name format for recorded files is set to include the user area first (if applicable), then the date, then the machine name
<b>User Area Name</b>	@0?UA\r	Name of the user area	@0UaXXXX\r	The name of the user area, where XXXX stands for the name
<b>User Area Setting</b>	@0?US\r	On	@0US00\r	DN-900R is set to include the user area in the names of recorded files
		Off	@0US01\r	DN-900R is set to exclude the user area from the names of recorded files
<b>Machine Name</b>	@0?MN\r	Current machine name	@0MNXXXX\r	The currently set machine name, where XXXX stands for the machine name
<b>Track Number</b>	@0?Tr\r	Number of the current track	@0Trnnnn\r	The current track's number within the file list, where <i>nnnn</i> (the track number) = <b>0000–2000</b>
<b>Tracklist Number</b>	@0?Tt\r	Total number of tracks	@0Ttnnnn\r	The total number of tracks in the currently selected folder, where <i>nnnn</i> (the total track number) = <b>0000–2000</b>
<b>Track Title (current; short)</b>	@0?ti\r	Title of the current track	@0tixxx\r	The title of the current track, where <i>xxxx</i> stands for up to 64 characters of the title
<b>Track Title (current; long)</b>	@0?T1	Title of the current track	@0T1xxxx	The title of the current track, where <i>xxxx</i> stands for up to 255 characters of the title
<b>Track Title (by 3-digit number)</b>	@0?TnNNM\r	Title of the current track	@0tnxxxx\r	The title of the track with the entered file number, where <i>NNN</i> (the file number) = <b>001–999</b> and <i>xxxx</i> stands for up to 64 characters of the title
<b>Track Title (by 4-digit number)</b>	@0?tnNNNM\r	Title of the track	@0tnxxxx\r	The title of the track with the entered file number, where <i>NNNN</i> (the file number) = <b>0001–2000</b> and <i>xxxx</i> stands for up to 64 characters of the title
<b>Artist Title (short)</b>	@0?at\r	Title of the artist	@0atxxx\r	The title of the artist for the current track, where <i>xxxx</i> stands for up to 64 characters of the title
<b>Artist Title (long)</b>	@0?T2	Title of the artist	@0T2xxxx	The title of the artist for the current track, where <i>xxxx</i> stands for up to 255 characters of the title
<b>Album Title (short)</b>	@0?a\r	Title of the album	@0alxxx\r	The title of the album for the current track, where <i>xxxx</i> stands for up to 64 characters of the title
<b>Album Title (long)</b>	@0?T3	Title of the album	@0T3xxxx	The title of the album for the current track, where <i>xxxx</i> stands for up to 255 characters of the title
<b>Track File Format</b>	@0?af\r	PCM	@0afPMNM\r	The current track is a PCM file, where <i>NN</i> (the bit length) = <b>16</b> or <b>24</b>

Status Request Commands (Host → DN-900R)		Status Information (DN-900R → Host)		DESCRIPTION
REQUEST	CODE	ANSWER	CODE	
Track File Format	@0?af\r	WAV	@0afWVNN	The current track is a WAV file, where <i>NN</i> (the bit length) = <b>16</b> or <b>24</b>
		MP3	@0afM3NNN\r	The current track is an MP3 file, where <i>NNN</i> stands for the bit rate in Kbps
		AIFF	@0afALNN\r	The current track is an AIFF file, where <i>NN</i> (the bit length) = <b>16</b> or <b>24</b>
		AAC	@0afACNNN\r	The current track is an AAC file, where <i>NNN</i> stands for the bit rate in Kbps
Track Size (by 3-digit number)	@0?Tsnnn\r	File size of the track	@0TsNNNNNN\r	The size of the track, where <i>nnn</i> (the track file number) = <b>001–999</b> and <i>NNNNNN</i> (the file size in KB) = <b>000001–999999</b>
Track Size (by 4-digit number)	@0?tsnnnn\r	File size of the track	@0tsNNNNNN\r	The size of the track, where <i>nnnn</i> (the track file number) = <b>0001–2000</b> and <i>NNNNNN</i> (the file size in KB) = <b>000001–999999</b>
Track Sample Rate	@0?fs\r	Sample rate	@0fsNN\r	The sample rate for the current track, where <i>NN</i> (the sample rate in kHz) = <b>44</b> (44.1), <b>48</b> , or <b>96</b>
Total Folder Number	@0?Tf\r	Number of folders	@0Tfnnnn\r	The total number of folders within the selected folder on the media source, where <i>nnnn</i> (the number of folders) = <b>0000–2000</b>
Hot Start Number	@0?HP\r	Current track's hot start number	@0HPnn\r	The hot start number for the current track, where <i>nn</i> (the hot start number) = <b>01–20</b>
Hot Start File Information	@0?Hsnn\r	Information on the current hot start track	@0Hsnnxxx:HHHmmsstt\r	The details for the current hot start track, where <i>nn</i> (the hot start number) = <b>00–20</b> , <i>xxx</i> stands for the file name, and <i>HHHmmsstt</i> (hours, minutes, seconds, and milliseconds elapsed in the track) = <b>0000000000–9995959999</b> <u>Note:</u> The file name will start with a number to indicate the media source: <b>1</b> for SD and <b>2</b> for USB
Track Length	@0?t\r	Length of the current track	@0tIMMMSSFF\r	The length of the current track, where <i>MMMSFF</i> (the length in minutes, seconds, and frames) = <b>000000–9995999</b>
Elapsed Track Time	@0?ET\r	Time elapsed in the current track	@0ETHhmmss\r	The amount of time that has elapsed in the current track, where <i>hmmss</i> (the amount of time in hours, minutes, and seconds) = <b>000000–9995959</b>
Remaining Track Time	@0?RM\r	Time remaining in the current track	@0RMhmmss\r	The amount of time remaining before the current track ends, where <i>hmmss</i> (the amount of time in hours, minutes, and seconds) = <b>000000–9995959</b>

Status Request Commands (Host → DN-900R)		Status Information (DN-900R → Host)		DESCRIPTION
REQUEST	CODE	ANSWER	CODE	
<b>Folder Name (current)</b>	@0?SF\r	Name of the selected folder	@0SFDXXX\r	The name of the folder containing the current track, where <i>D</i> (media source indicator) = <b>1–2</b> and <i>XXX</i> stands for the folder name <u>Note:</u> 1 indicates SD and 2 indicates USB
<b>Folder Name (by number)</b>	@0?Fnxxxx\r	Name of the folder	@0FnXXX\r	The name of the folder corresponding to the entered folder number, where <i>xxxx</i> (the folder number) = <b>0001–2000</b> and <i>XXX</i> stands for the folder name
<b>File Sort Setting</b>	@0?FR\r	Alphabetically	@0FRAL\r	Files in any folder are set to be sorted alphabetically
		By date	@0FRDA\r	Files in any folder are set to be ordered by date
<b>File List Status</b>	@0?UL\r	Not changed	@0UL00\r	The file list in the current folder has not been changed since the last query
		Updated	@0UL01\r	The file list in the current folder has been changed since the last query
<b>Playback Range</b>	@0?pR\r	All	@0pRAL\r	DN-900R is set to include all tracks on the selected media source in the current tracklist
		Folder	@0pRFD\r	DN-900R is set to include only tracks from the selected folder in the current tracklist
<b>Playback Mode</b>	@0?PM\r	Single Play	@0PMSP\r	DN-900R is set to stop playback after the currently playing track ends
		Continuous	@0PMC�\r	DN-900R is set to continuously play through all tracks in the current tracklist
<b>Random Setting</b>	@0?RN\r	On	@0RN01\r	Random playback is activated
		Off	@0RN00\r	Random playback is deactivated
<b>Repeat Setting</b>	@0?RE\r	On	@0RE00\r	The repeat feature is turned on
		Off	@0RE01\r	The repeat feature is turned off
<b>Program List Setting</b>	@0?PG\r	Off	@0PG00\r	No program list is loaded and set for playback
		On	@0PG01\r	DN-900R is set to play the currently loaded program list
<b>Total Program Lists</b>	@0?tP	Number of program lists	@0tPnn	The total number of saved program lists, where <i>nn</i> = <b>00–99</b>
<b>Program List Name</b>	@0?plnn	Name of the program list	@0plxxxx	The file name of the program list corresponding to the entered program list number, where <i>nn</i> (the program list number) = <b>00–99</b> and <i>xxxx</i> stands for the file name

Status Request Commands (Host → DN-900R)		Status Information (DN-900R → Host)		DESCRIPTION
REQUEST	CODE	ANSWER	CODE	
<b>Finish Mode</b>	@0?FM\r	Stop	@0FMST\r	DN-900R is set to stop playback of the current track upon executing the stop command
		Next	@0FMNT\r	DN-900R is set to cue the next track in the tracklist upon executing the stop command
		Recue	@0FMRC\r	DN-900R is set to skip to the point at which playback was previously started upon executing the stop command
<b>Auto Cue Setting</b>	@0?AC\r	Off	@0AC00\r	The auto cue feature is turned off
		On	@0ACNN\r	DN-900R is set to skip audio in the beginning of tracks that is below a specific volume threshold, where <i>NN</i> (the volume threshold in -dB) = <b>36, 42, or 48</b>
<b>Recording Input Routing (Signal Pass Thru Setting)</b>	@0?Sp\r	Unchanged	@0Sp00\r	DN-900R is set to route the recording input signal through the audio outputs
		Changed	@0Sp01\r	DN-900R is set to not route the recording input signal through the audio outputs
<b>Recording Timer Setting</b>	@0?ShNM\r	Recording scheduled by day(s) of the week	@0ShDWxxxxxx HHMMhhmmUU UUU\r	<p>The scheduled recording is set at a specific day and time:</p> <ul style="list-style-type: none"> <li>• <i>NN</i> (the record timer setting number) = <b>01–30</b></li> <li>• <i>xxxxxx</i> (the day or days of the week) = <b>SMTWTFS</b> and/or <b>_</b>; see note below for details</li> <li>• <i>HHMM</i> (the start time in hours and minutes) = <b>0000–2359</b></li> <li>• <i>hhmm</i> (the duration of the recording in hours and minutes) = <b>0000–2359</b></li> <li>• <i>UUUUU</i> stands for a user area name of up to 32 characters</li> </ul> <p><u>Note:</u> For the <i>xxxxxx</i> variable, <b>_</b> indicates that the corresponding day of the week will be skipped</p> <p><u>Note:</u> For the <i>HH</i> variable, <b>**</b> indicates hourly scheduling</p>



Status Request Commands (Host → DN-900R)		Status Information (DN-900R → Host)		DESCRIPTION
REQUEST	CODE	ANSWER	CODE	
Recording Timer Setting	@0?ShNM\r	Recording scheduled by date and time	@0ShDTYYMMD DHHMMhhmmU UUUU\r	<p>The scheduled recording is set at a specific time and date:</p> <ul style="list-style-type: none"> <li>• <i>NN</i> (the record timer setting number) = <b>01–30</b></li> <li>• <i>YYMMDD</i> (the year, month, and date to start recording) = <b>130101–351231</b></li> <li>• <i>HHMM</i> (the start time in hours and minutes) = <b>0000–2359</b></li> <li>• <i>hhmm</i> (the duration of the recording in hours and minutes) = <b>0000–2359</b></li> <li>• <i>UUUUU</i> stands for a user area name of up to 32 characters</li> </ul> <p><u>Note:</u> An entry of <b>**</b> for the <i>YY</i> variable indicates annual scheduling; an entry of <b>**</b> for the <i>MM</i> variable indicates monthly scheduling</p>
		Playback scheduled by day(s)	@0TPDWxxxxxxx hhmmFFFF\r	<p>The scheduled playback is set at a specific day and time:</p> <ul style="list-style-type: none"> <li>• <i>NN</i> (the playback timer setting number) = <b>01–30</b></li> <li>• <i>xxxxxxx</i> (the day or days of the week) = <b>SMTWTFS</b> and/or <b>_</b>; see note below for more details</li> <li>• <i>hhmm</i> (the start time in hours and minutes) = <b>0000–2359</b></li> <li>• <i>FFFF</i> stands for the name of the file to be played</li> </ul> <p><u>Note:</u> For the <i>xxxxxxx</i> variable, an entry of <b>_</b> indicates that the corresponding day will be skipped</p> <p><u>Note:</u> For the <i>HH</i> variable, an entry of <b>**</b> indicates hourly scheduling</p>
Playback Timer Setting	@0?TPNM\r	Playback scheduled by date and time	@0TPDTYYMMD DhhmmFFFF\r	<p>The scheduled playback is set at a specific time and date:</p> <ul style="list-style-type: none"> <li>• <i>NN</i> (the playback timer setting number) = <b>01–30</b></li> <li>• <i>YYMMDD</i> (the year, month, and date to start playback) = <b>130101–351231</b></li> <li>• <i>hhmm</i> (the start time in hours and minutes) = <b>0000–2359</b></li> <li>• <i>FFFF</i> stands for the name of the file to be played</li> </ul> <p><u>Note:</u> An entry of <b>**</b> for the <i>YY</i> variable indicates annual scheduling; an entry of <b>**</b> for the <i>MM</i> variable indicates monthly scheduling</p>

Status Request Commands (Host → DN-900R)		Status Information (DN-900R → Host)		DESCRIPTION
REQUEST	CODE	ANSWER	CODE	
<b>Archive Timer Setting</b>	@0?as\r	Archiving scheduled by day(s)	@0asDWxxxxxxh hmm\r	<p>The scheduled archiving is set at a specific day and time:</p> <ul style="list-style-type: none"> <li>xxxxxxx (the day or days of the week that the archiving will take place) = <b>SMTWTFS</b> and/or <b>_</b>; see note below for details</li> <li>HHMM (the time that the archiving will take place in hours and minutes) = <b>0000–2359</b></li> </ul> <p><u>Note:</u> For the xxxxxx variable, an entry of <b>_</b> indicates that the corresponding day will be skipped</p> <p><u>Note:</u> For the HH variable, an entry of <b>**</b> indicates hourly scheduling</p>
		Archiving scheduled by date and time	@0asDTYYMMDD hmm\r	<p>The scheduled archiving is set at a specific time and date, where YYMMDD (the year, month, and date to archive the files) = <b>130101–351231</b> and hhmm (the time to archive the files in hours and minutes) = <b>0000–2359</b></p> <p><u>Note:</u> An entry of <b>**</b> for the YY variable indicates annual scheduling; an entry of <b>**</b> for the MM variable indicates monthly scheduling</p>
<b>Current Timer</b>	@0?Ct\r	Record timer	@0CtREnn\r	The current record timer, where nn (the record timer number) = <b>01–30</b>
		Playback timer	@0CtPLnn\r	The current playback timer, where nn (the playback timer number) = <b>01–30</b>
<b>Reserved Timer</b>	@0?Rt\r	Record timer	@0RtREnn\r	The reserved record timer, where nn (the record timer number) = <b>01–30</b>
		Playback timer	@0RtPLnn\r	The reserved playback, where nn (the playback timer number) = <b>01–30</b>
<b>Timer Priority</b>	@0?tp\r	On	@0tp00\r	Scheduled playback will start as long as recording is not in progress
		Off	@0tp01\r	Scheduled playback will only start if DN-900R is paused, stopped, or in standby

Status Request Commands (Host → DN-900R)		Status Information (DN-900R → Host)		DESCRIPTION
REQUEST	CODE	ANSWER	CODE	
<b>Pitch/Speed</b>	@0?PT\r	Pitch/speed setting	@0PTSSXXXX\r	<p>The current pitch/speed setting, where SS (the pitch-control on/off setting) = <b>ON</b> or <b>OF</b> and XXXX (the pitch/speed value as a percentage of the default pitch/speed between -16% and 16%) = <b>1160-0160</b></p> <p><u>Note:</u> In the XXXX variable, a first digit of 0 makes the percentage positive, a first digit of 1 makes the percentage negative, and the last three digits are the pitch/speed value in multiples of 0.1%</p> <p>For example, if the pitch/speed is currently set to +14.5%, DN-900R will answer with this code: @0PTON0145; if the pitch/speed is currently set to -8.0%, DN-900R will answer with this code: @0PTON1080</p>
<b>Master Key</b>	@0?KY\r	On	@0KY00\r	DN-700R is set so that using the pitch/speed control will only change the speed
		Off	@0KY01\r	DN-700R is set so that using the pitch/speed control will change both the speed and pitch
<b>Mark Number</b>	@0?Tm\r	Total mark number	@0TmNN\r	The total number of marks in the current track, where NN = <b>00-99</b>
<b>Mark Time</b>	@0?Mtnn\r	Time position of the mark	@0Mthhmmssff\r	The time position of the mark, where nn (the mark number) = <b>00-30</b> and hhhmmssff (the time position of the mark in hours, minutes, seconds, and frames) = <b>00000001-99595999</b>
<b>Auto Mark Setting</b>	@0?AM\r	On	@0AM00\r	The auto mark feature is activated
		Off	@0AM01\r	The auto mark feature is deactivated
<b>Silent Skip Setting</b>	@0?SS\r	On	@0SS00\r	The silent skip feature is activated
		Off	@0SS01\r	The silent skip feature is deactivated
<b>Skip Back Time</b>	@0?SB\r	Amount of skip back time	@0SBNNN\r	The number of seconds that a track will rewind when Skip Back is executed, where NNN (the number of seconds in multiples of 0.1) = <b>005-600</b> (0.5 second - 60 seconds)
<b>Auto Fade In Setting</b>	@0?FI\r	Amount of fade in time	@0FLnn\r	How long a track will fade in when playback is initiated, where nn (the length of the fade) = <b>00</b> (off/no fade in), <b>05</b> (500 milliseconds), <b>10</b> (1 second), or <b>30</b> (3 seconds)

Status Request Commands (Host → DN-900R)		Status Information (DN-900R → Host)		DESCRIPTION
REQUEST	CODE	ANSWER	CODE	
<b>Auto Fade Out Setting</b>	@0?FO\r	Amount of fade out time	@0FO $nn$ \r	How long a track will fade out before playback ends, where $nn$ (the length of the fade) = <b>00</b> (off/no fade out), <b>05</b> (500 milliseconds), <b>10</b> (1 second), or <b>30</b> (3 seconds)
<b>Playback Delay Setting</b>	@0?sD\r	Amount of delay time	@0sD $nnn$ \r	How long of a delay there will be after track playback is initiated, where $nnn$ (the length of the delay) = <b>000</b> (off/no delay), <b>010</b> (100 milliseconds), <b>020</b> (200 milliseconds), or <b>030</b> (300 milliseconds)
<b>End of Message Setting</b>	@0?ED\r	End of message time	@0ED $NM$ \r	Sets how long before the end of a track it will take before the “End of Message” icon displays, where $nn$ (the length of time in seconds) = <b>00</b> , <b>05</b> , <b>10</b> , <b>15</b> , <b>20</b> , <b>30</b> , <b>60</b> , or <b>OF</b> (turns the EOM feature off)
<b>Track Channel</b>	@0?ch\r	Stereo	@0chST\r	The current track is a stereo file
		Mono	@0chMO\r	The current track is a mono file
<b>Search Mode</b>	@0?sM\r	Audible	@0sMNO\r	Tracks will be audible while searching
		Silent	@0sMSL\r	Tracks will be silent while searching
<b>Mono Playback Setting</b>	@0?MO\r	On	@0MO00\r	DN-900R is set to playback audio in mono
		Off	@0MO01\r	DN-900R is not set to playback audio in mono
<b>Audio Output Rate</b>	@0?dF\r	Auto	@0dFAT\r	The audio output sample rate is set to automatic (the sample rate will automatically match that of the input source/file)
		44.1 kHz	@0dF44\r	The audio output sample rate is set to 44.1 kHz
		48 kHz	@0dF48\r	The audio output sample rate is set to 48 kHz
		Ext (AES)	@0dFEX\r	The audio output sample rate will be set using an external clock for the digital signal
<b>Left Channel Input Adjustment</b>	@0?ItL\r	Amount of volume adjustment	@0ItLY $NM$ \r	The amount of dB that the left channel input is set to be lowered or raised, where $YNN$ (the volume adjustment in multiples of 0.1 dB) = <b>-20</b> – <b>+20</b> For example, if the left channel input is set to be increased by 1.5 dB, DN-900R will answer with this code: @0ItL+15
<b>Right Channel Input Adjustment</b>	@0?ItR\r	Amount of volume adjustment	@0ItRY $NM$ \r	The amount of dB that the right channel input is set to be lowered or raised, where $YNN$ (the volume adjustment in multiples of 0.1 dB) = <b>-20</b> – <b>+20</b>

Status Request Commands (Host → DN-900R)		Status Information (DN-900R → Host)		DESCRIPTION
REQUEST	CODE	ANSWER	CODE	
<b>Left Channel Output Adjustment</b>	@0?OtL\r	Amount of volume adjustment	@00tLYNM\r	The amount of dB that the left channel output is set to be lowered or raised, where <i>YNN</i> (the volume adjustment in multiples of 0.1 dB) = <b>-20 – +20</b>
<b>Right Channel Output Adjustment</b>	@0?OtR\r	Amount of volume adjustment	@00tRYNM\r	The amount of dB that the right channel output is set to be lowered or raised, where <i>YNN</i> (the volume adjustment in multiples of 0.1 dB) = <b>-20 – +20</b>
<b>XLR Left Channel Input Voltage Level</b>	@0?LML\r	Line	@0LMLLN\r	The XLR left channel input is set to line level
		Mic	@0LMLMC\r	The XLR left channel input is set to mic level
<b>XLR Right Channel Input Voltage Level</b>	@0?LMR	Line	@0LMRLN\r	The XLR right channel input is set to line level
		Mic	@0LMRMC\r	The XLR right channel input is set to mic level
<b>Phantom Power Setting (XLR Left Channel Input)</b>	@0?PhL\r	On	@0PhL00\r	Phantom power is turned on for the XLR left channel input
		Off	@0PhL01\r	Phantom power is turned off for the XLR left channel input
<b>Phantom Power Setting (XLR Right Channel Input)</b>	@0?PhR	On	@0PhR00\r	Phantom power is turned on for the XLR right channel input
		Off	@0PhR01\r	Phantom power is turned off for the XLR right channel input
<b>Mic Input Sensitivity (Left Channel)</b>	@0?MsL\r	Sensitivity Value	@0MsLNM\r	The mic input sensitivity setting for the XLR left channel input, where <i>NN</i> (the mic input sensitivity level in –dBu) = <b>16–60</b>
<b>Mic Input Sensitivity (Right Channel)</b>	@0?MsR\r	Sensitivity Value	@0MsRNM\r	The mic input sensitivity setting for the XLR right channel input, where <i>NN</i> (the mic input sensitivity level in –dBu) = <b>16–60</b>
<b>Reference Value (XLR/RCA)</b>	@0?Fr\r	Reference Value	@0FrNM\r	The reference value, where <i>NN</i> = <b>24</b> (+24 dBu for XLR / +10 dBv for RCA), <b>20</b> (+20 dBu for XLR / +6 dBv for RCA), or <b>18</b> (+18 dBu for XLR / +4 dBv for RCA)
<b>FTP (Archive) Server IP Address</b>	@0?AI\r	IP address of the archive network	@0Ainnn\r	The IP address for the network to which archived recordings will be saved, where <i>nnnn</i> stands for the IP address (omitting periods)
<b>FTP (Archive) Server User Name</b>	@0?AU\r	User name for the archive network	@0AUxxxx\r	The currently set user name for the network to which archived recordings will be saved, where <i>xxxx</i> stands for the user name

Status Request Commands (Host → DN-900R)		Status Information (DN-900R → Host)		DESCRIPTION
REQUEST	CODE	ANSWER	CODE	
<b>FTP (Archive) Server Folder</b>	@0?AO\r	Archive network folder	@0AOxxxx\r	The currently set folder in which archived recordings will be saved, where <i>xxxx</i> stands for the folder name
<b>Device IP Address</b>	@0?IP\r	DN-900R's IP address	@0Ipnnnn\r	DN-900R's assigned IP address, where <i>nnnn</i> stands for the IP address (omitting periods)
<b>Subnet Mask</b>	@0?SM\r	Subnet mask number	@0SMnnnn\r	DN-900R's assigned subnet mask, where <i>nnnn</i> stands for the subnet mask number (omitting periods)
<b>Gateway Address</b>	@0?GW\r	Gateway address number	@GWnnnn\r	DN-900R's assigned gateway address, where <i>nnnn</i> stands for the address number (omitting periods)
<b>DNS Server Address</b>	@0?DN\r	DNS server address number	@0DNnnnn\r	DN-900R's assigned DNS server address, where <i>nnnn</i> stands for the address number (omitting periods)
<b>IP Control Port</b>	@0?Ip\r	Current control port number	@0IpNNNNM\r	The currently set IP control port number, where <i>NNNNN</i> (the number) = <b>00000–65535</b>
<b>NTP Server</b>	@0?NP\r	NTP server address number	@0NPnnnn\r	The currently set NTP server address, where <i>nnnn</i> stands for the address number (omitting periods)
<b>NTP Cycle</b>	@0?NC\r	Cycle time	@0NChhmm\r	The currently set NTP cycle time in hours and minutes, where <i>hhmm</i> (the cycle time in hours and minutes) = <b>0015–2400</b>
<b>Syslog</b>	@0?SI\r	Syslog address number	@0SLnnnn\r	The syslog server address, where <i>nnnn</i> stands for the address number (omitting periods)
<b>IP Authentication Setting</b>	@0?Ia\r	On	@0Ia00\r	DN-900R's web remote control is currently set to require a password
		Off	@0Ia01\r	DN-900R's web remote control is currently set to not require a password
<b>Update File Transfer for IP Remote</b>	@0?UTxxxx\r	OK	@0UTOK\r	Stop mode only, where <i>xxxx</i> stands for the update file size
		NG	@0UTNG\r	Excluding stop, where <i>xxxx</i> stands for the update file size
<b>Network Standby Setting</b>	@0?Ns\r	On	@0Ns00\r	DN-900R is set so that it can be controlled from the web remote when it is in standby
		Off	@0Ns01\r	DN-900R is set so that it cannot be controlled from the web remote when it is in standby
<b>Lock Status</b>	@0?LS\r	Locked	@0LSLK\r	The front panel buttons are currently locked
		Unlocked	@0LSUL\r	The front panel buttons are currently unlocked

Status Request Commands (Host → DN-900R)		Status Information (DN-900R → Host)		DESCRIPTION
REQUEST	CODE	ANSWER	CODE	
<b>Lock Status</b>	@0?LS\r	Semi-locked	@0LSSL\r	The front panel buttons are partially locked
<b>Shift Mode</b>	@0?Sm\r	Momentary	@0SmMO\r	The shift control is momentarily engaged and will disengage after the next control is used
		Locked	@0SmLK\r	The shift control will remain engaged until it is manually disengaged
<b>Auto Reboot Setting</b>	@0?Ar\r	On	@0Ar00\r	DN-900R is set to automatically reboot if the main processor freezes
<b>Auto Reboot Setting</b>	@0?Ar\r	Off	@0Ar01\r	DN-900R is not set to automatically reboot if the main processor freezes
<b>Date Format</b>	@0?DF\r	MDY	@0DFMD\r	The display is set to show the date in month/day/year format
		DMY	@0DFDM\r	The display is set to show the date in day/month/year format
		YMD	@0DFYM\r	The display is set to show the date in year/month/day format
<b>Date &amp; Time</b>	@0?Dt\r	Current date and time	@0DtYYMMDDhhmm\r	The current date and time setting on DN-900R, where YYMMDD (the year, month, and day of the month) = <b>130101-351231</b> and hhmm (the time in hours and minutes) = <b>0000-2359</b>
<b>Time Zone</b>	@0?TZ\r	Current time zone setting	@0TZxHHMM\r	DN-900R's currently set time zone, where x (the offset direction) and HHMM (the offset amount in hours and minutes) = <b>-1200 - +1400; +0000</b> is GMT
<b>Time Notation Setting</b>	@0?TF\r	12H	@0TF12\r	The display is set to show the time in a 12-hour AM/PM clock format
		24H	@0TF24\r	The display is set to show the time in a 24-hour clock format
<b>Time Display</b>	@0?TD\r	HH:MM:SS	@0TDHMS\r	The clock on the display is formatted as hours:minutes:seconds
		MMM:SS:FF	@0TDMSF\r	The clock on the display is formatted as minutes:seconds:frames
<b>Daylight Savings Setting</b>	@0?dS\r	On	@0dS00\r	DN-900R is set to observe daylight savings time
		Off	@0dS01\r	DN-900R is set to not observe daylight savings time
<b>Daylight Savings Offset</b>	@0?do\r	Daylight savings offset time	@0dohhmm\r	The daylight savings offset time, where hhmm (the offset time in hours and minutes) = <b>0000-0600</b>
<b>Daylight Savings Start</b>	@0?ds\r	Daylight savings start date/time	@0dsMMDDhhmm\r	The date and time that DN-900R will begin observing daylight savings time, where MMDD (the date) = <b>0101-1231</b> and hhmm (the time) = <b>0000-2359</b>

Status Request Commands (Host → DN-900R)		Status Information (DN-900R → Host)		DESCRIPTION
REQUEST	CODE	ANSWER	CODE	
<b>Daylight Savings End</b>	@0?de\r	Daylight savings end date/time	@0deMMDDhmm\r	The date and time that DN-900R will stop observing daylight savings time, where <i>MMDD</i> (the date) = <b>0101–1231</b> and <i>hhmm</i> (the time) = <b>0000–2359</b>
<b>Dimmer Setting</b>	@0?DM\r	On	@0DM00\r	The dimmer is turned on
		Off	@0DM01\r	The dimmer is turned off
<b>Display Brightness</b>	@0?DD\r	Display brightness percentage	@0DDNM\r	The brightness of the display screen, where <i>NN</i> (the brightness setting) = <b>00</b> (100%), <b>01</b> (75%), <b>02</b> (50%), <b>03</b> (25%), or <b>04</b> (0%)
<b>LED Brightness</b>	@0?LD\r	LED brightness percentage	@0LDNM\r	The brightness of the LEDs, where <i>NN</i> (the brightness setting) = <b>00</b> (100%), <b>01</b> (75%), <b>02</b> (50%), or <b>03</b> (25%)
<b>Display Contrast</b>	@0?BN\r	Contrast value	@0BNNM\r	The contrast level for the display, where <i>NN</i> (the contrast level) = <b>01–05</b>
<b>Screen Saver Setting</b>	@0?Ss\r	On	@0Ss00\r	The screen saver feature is turned on
		Off	@0Ss01\r	The screen saver feature is turned off
<b>Language</b>	@0?LN\r	English	@0LNUS\r	The system language is currently set to English
		Japanese	@0LNJP\r	The system language is currently set to Japanese
<b>Keyboard Language</b>	@0?KB\r	English (US)	@0KBUS\r	The keyboard language is set to American English
		English (UK)	@0KBUK\r	The keyboard language is set to British English
		French	@0KBFR\r	The keyboard language is set to French
		German	@0KBGE\r	The keyboard language is set to German
		Italian	@0KBIT\r	The keyboard language is set to Italian
		Spanish	@0KBSP\r	The keyboard language is set to Spanish
		Dutch	@0KBNE\r	The keyboard language is set to Dutch
		Swedish	@0KBSW\r	The keyboard language is set to Swedish
		Japanese	@0KBJP\r	The keyboard language is set to Japanese
<b>Preset Number</b>	@0?PS\r	Number of the preset setting	@0PSNM\r	The number of the currently selected preset setting, where <i>NN</i> = <b>01–03</b>
<b>Preset Title</b>	@0?PNn\r	Title of the preset setting	@0PNnxxxx\r	The name of the preset setting, where <i>n</i> (the preset setting number) = <b>1–3</b> and <i>xxxx</i> stands for up to 32 characters of the name



Status Request Commands (Host → DN-900R)		Status Information (DN-900R → Host)		DESCRIPTION
REQUEST	CODE	ANSWER	CODE	
<b>Version</b>	@0?VNr	Version/model	@0VNnnnnnnnnM MMM <sub>r</sub>	The eight-digit version number and model name for your device, where <i>nnnnnnnn</i> stands for the version number and <i>MMMM</i> stands for the model name

## Automatic Status Information Codes

In the event that a change is made to DN-900R from the device itself, DN-900R may automatically send status information to the host. See below for the status information codes that can be automatically sent to the host.

Automatic Status Information (Host → DN-900R)			
CATEGORY	CONTENTS	CODE	DESCRIPTION
<b>Media Selection</b>	USB	@0MEUS\r	The USB drive was selected as the current media source
	SD1	@0MES1\r	SD Card 1 was selected as the current media source
	SD2	@0MES2\r	SD Card 2 was selected as the current media source
	Network	@0MENE\r	The network was selected as the current media source
<b>Media Status</b>	SD Card In	@0CDCI\r	An SD card was inserted into one of the SD slots
	SD Card Out	@0CDNC\r	The SD card was ejected
	SD Card Error	@0CDCE\r	There was an error with the SD card
	Unformatted SD Card	@0CDUFR\r	An unformatted SD card was inserted into one of the SD slots
	Write Protected SD Card	@0CDWPR\r	A write protected SD card was inserted into one of the SD slots
	SD Card Door Opened	@0CDDO\r	The SD slot door was opened
<b>Device Status</b>	Recording	@0STRE\r	A recording was started
	Recording Paused	@0STRP\r	The current recording was paused
	DIR Unlocked	@0STRU\r	With the recording audio source set to one of the digital inputs, the digital interface receiver was unlocked
	Playing	@0STPL\r	Playback of the current track was initiated
	Repeat playing	@0STAB\r	Playback of the current track was initiated (with the A-B repeat feature activated)
	Paused	@0STPP\r	The current track was paused
	Repeat Paused	@0STPR\r	The current track was paused (with the repeat feature activated)
	Rewinding	@0STRW\r	The current track is being rewound
	Fast Forwarding	@0STFF\r	The current track is being fast forwarded
	Stopped	@0STST\r	The current tracklist was stopped
	Cued	@0STCU\r	A track was cued
	Autocueing	@0STAC\r	A track was autocued
	Timer Standby	@0STSH\r	Pre-scheduled recording or playback was automatically initiated
	Loading	@0STLD\r	DN-900R is currently loading
Busy	@0STBY\r	DN-900R is currently busy	

Automatic Status Information (Host → DN-900R)			
CATEGORY	CONTENTS	CODE	DESCRIPTION
<b>Device Status</b>	File List Opening	@0STFL\r	The file list was opened
	Main Menu Opening	@0STED\r	The main menu was opened
	Error	@0STER\r	There is an operation error
<b>File/Folder Selection</b>	Track Change	@TrNNNN\r	The current track was changed, where <i>NNNN</i> (the file number for the newly selected track) = <b>0001–2000</b>
	Folder Change	@0SFXXXX\r	The currently selected folder was changed, where <i>XXXX</i> stands for the name of the newly selected folder
	Total Track Number Change	@0TtNNNN\r	The total number of tracks in the currently selected folder was changed, where <i>NNNN</i> (the new number of tracks in the currently selected folder) = <b>0001–2000</b>
	Total Folder Number	@0TfNNNN\r	The total number of folders within the currently selected folder on the current media source was changed, where <i>NNNN</i> (the new number of folders) = <b>0000–2000</b>
<b>Error</b>	Device Error	@0ERnnxxx\r	There is an error with the device, where <i>xxxx</i> stands for the error code and <i>nn</i> (the number of seconds that the error will be shown on the display screen) = <b>01–99</b> ; if <b>00</b> is shown for the <i>nn</i> variable, the display will show the error until the error is resolved

## Appendix

### Acceptable Characters for Serial Communication

The table below lists all the characters that are allowed in serial communication between the host and DN-900R. Use this table to determine which characters are acceptable for command codes requiring you to create a name (such as a folder or file name).

	X0	X1	X2	X3	X4	X5	X6	X7	X8	X9	XA	XB	XC	XD	XE	XF
0X																
1X																
2X	<i>SP</i>	!	“	#	\$	%	&	‘	(	)	*	+	,	-	.	/
3X	0	1	2	3	4	5	6	7	8	9	:	;	<	=	>	?
4X	@	A	B	C	D	E	F	G	H	I	J	K	L	M	N	O
5X	P	Q	R	S	T	U	V	W	X	Y	Z	[	\	]	^	_
6X	`	a	B	c	D	e	f	g	h	I	j	k	l	m	n	o
7X	p	q	R	s	T	u	v	w	x	Y	z	{		}	~	<i>DEL</i>
8X																
9X																
AX	<i>NBSP</i>	ı	¢	£	¤	¥	¦	§	¨	©	ª	«	¬	-	®	¯
BX	°	±	²	³	´	µ	¶	·	¸	¹	º	»	¼	½	¾	¿
CX	À	Á	Â	Ã	Ä	Å	Æ	Ç	È	É	Ê	Ë	Ì	Í	Î	Ï
DX	Ð	Ñ	Ò	Ó	Ô	Õ	Ö	×	Ø	Ù	Ú	Û	Ü	Ý	Þ	ß
EX	à	á	â	ã	Ä	å	æ	ç	è	É	ê	ë	ì	í	î	ï
FX	ð	ñ	ò	ó	Ô	õ	ö	÷	ø	Ù	ú	û	ü	ý	þ	ÿ

**Note:** For the “Create Admin Password” (@0PDxxxx\r), “Create Operator Password” (@0OPxxxx\r), and “Create Observer Password” (@0Opxxxx\r) control commands, the acceptable characters for the xxxx variable are only those between 0x21 and 0x7E (with the further exception of 0x3A).

**Note:** For the “Create FTP (Archive) Server User Name” (@0Auxxxx\r) and “Create FTP (Archive) Server Password” (@0Apxxxx\r) control commands, the acceptable characters for the xxxx variable are only those between 0x20 and 0x7E (with the further exceptions of 0x3A and 0x22).

**Note:** For the “Edit Machine Name” control command (@0MNxxxx\r), the acceptable characters for the xxxx variable are only those which are alphanumeric, 0x2D, and 0x5F.

## Entering the Absolute Path for Folder and File Names

For control command codes that require you to enter a folder or file name, you may or may not have to enter the absolute path. This is indicated in the descriptions for applicable control command codes as “absolute path required” or “absolute path not required.”

When the absolute path is required, the location of the folder or file in the currently selected media source’s root folder must be specified in the entered folder or file name. The separator used to distinguish between folders within the path must be 0x2F (/). Also, all absolute paths must begin with 0x2F (/) in order to signify the root directory.

For example, if you were to assign a hot start number of 05 to a track file named “Song1” in the “Rock” folder within the “Music” folder on the root directory, you will need to enter the control command code @0HsnnXXXXr. *nn* stands for the hot start number, and *XXXX* stands for the track file name with the absolute path required. Therefore, the complete code you would need to enter would be **@0Hs05/Music/Rock/Song1\r**.

When the absolute path is not required, enter only the name of the folder or file (and do not include its location in the currently selected media source’s root folder).

## RS-232C Specifications

<b>Compatible Connector</b>	9-Pin D-sub Male	
<b>Transmission System</b>	Asynchronous Full Duplex	
<b>Transfer Rate</b>	9600 or 38400 bps	
<b>Data Length</b>	8 bits	
<b>Parity</b>	None	
<b>Start Bit</b>	1 bit	
<b>Stop Bit</b>	1 bit	
<b>Flow Control</b>	None	
<b>Maximum Data Length</b>	600 bytes	
<b>Pin Arrangement</b>	<b>Pin Number</b>	<b>Signal Name</b>
	1	Ground
	6	NC
	2	TxD
	7	RTS*
	3	RxD
	8	NC
	4	NC
	9	NC
5	S. Ground	

\*4 V / 500 mA power supply can be used for RTS.

## Ethernet Specifications

<b>Compatible Connector</b>	RJ45 Male
<b>Transmission System</b>	Full Duplex
<b>Transfer Rate</b>	10 Mbps / 100 Mbps
<b>TCP Port Number</b>	23 (telnet)
<b>Maximum Data Length</b>	288 bytes

## Trademarks & Licenses

Denon is a trademark of D&M Holdings Inc., registered in the U.S. and other countries. Denon Professional products are produced by inMusic Brands, Inc., Cumberland, RI 02864, USA.

All other product names, company names, trademarks, or trade names are those of their respective owners.



**denonpro.com**