



IPD-SM-EZ Series

Install Instructions For:

IPD-SM52-EZ, IPD-SM52-EZ-WX, IPD-SM82-EZ-II, and IPD-SM82-EZ-II-WX

Box contents

- 1 Speaker
- 1 U-bracket
- 3 U-bracket screws
- 2 Screw caps
- 1 Allen wrench
- 1 Back plate
- 1 Port plug
- 1 Safety cable
- 1 Strain relief water tight gland

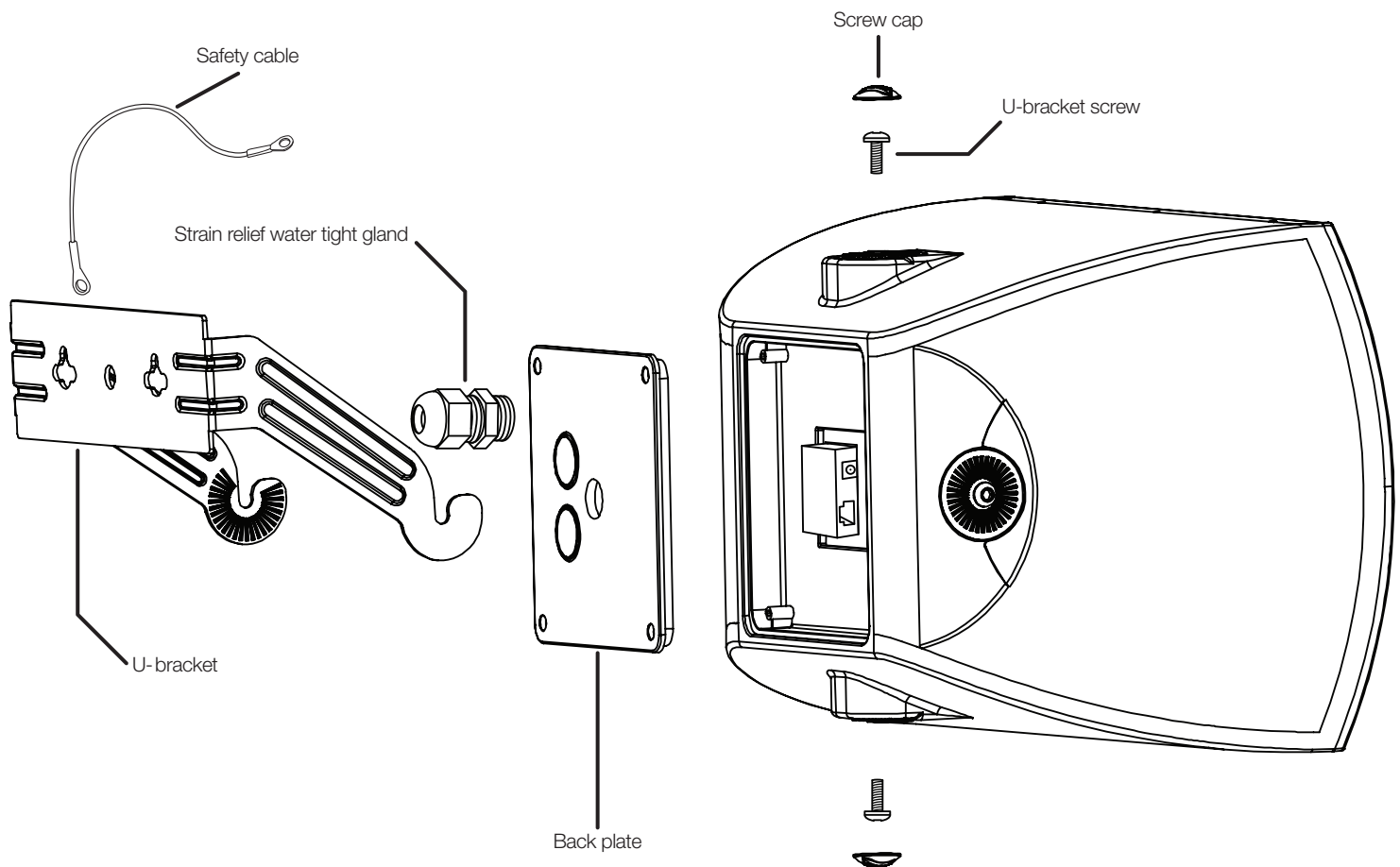

913.663.5600 | www.soundtube.com

© 2023 SoundTube Entertainment, Inc. All rights reserved. PN IPD-INS-SM-EZ Rev 05-06-2025

Warning

SoundTube speakers must be installed by a professional audio installer/contractor. For safety and for optimum audio performance, installer must follow all directions issued by SoundTube Entertainment.

Warning

Do not spec or install speaker near support beam, ventilation duct or other structure that may interfere with speaker function or dispersion.

Important Safety Instructions

- 1) Read these instructions.
- 2) Keep these instructions.
- 3) Heed all warnings.
- 4) Follow all instructions.
- 6) Clean only with dry cloth.
- 7) Do not block any ventilation openings. Install in accordance with the manufacturer's instructions.
- 8) Do not install near any heat sources such as radiators, heat registers, stoves, or other apparatus (including amplifiers) that produce heat.
- 9) Only use the attachments/accessories specified by the manufacturer.
- 10) Unplug this apparatus during lightning storms or when unused for long periods of time.
- 11) Refer all servicing to qualified service personnel. Servicing is required when the apparatus has been damaged in any way, such as power-supply cord or plug is damaged, the apparatus has been exposed to rain or moisture, does not operate normally, or has been dropped.

Warning

To reduce the risk of fire or electric shock, do not expose this apparatus to rain or moisture.

Consignes de sécurité importantes

- 1) Lisez ces instructions.
- 2) Conservez ces instructions.
- 3) Respectez tous les avertissements.
- 4) Suivez toutes les instructions.
- 6) Nettoyer seulement avec un chiffon sec.
- 7) Ne pas bloquer les ouvertures de ventilation. Installer conformément aux instructions du fabricant.
- 8) Ne pas installer près de sources de chaleur telles que des radiateurs, registres de chaleur, poêles ou autres appareils (incluant les amplificateurs) qui produisent de la chaleur.
- 9) Utiliser uniquement les fixations / accessoires spécifiés par le fabricant.
- 10) Débranchez cet appareil pendant les orages ou si inutilisé pendant de longues périodes de temps.
- 11) Confiez toute réparation à un personnel qualifié. Une réparation est nécessaire lorsque l'appareil a été endommagé de quelque façon que ce cordon d'alimentation ou la fiche est endommagé, l'appareil a été exposé à la pluie ou à l'humidité, s'il ne fonctionne pas normalement ou s'il est tombé.

Avis

Pour réduire les risques d'incendie ou de choc électrique n'exposez pas cet appareil à la pluie ou à l'humidité.

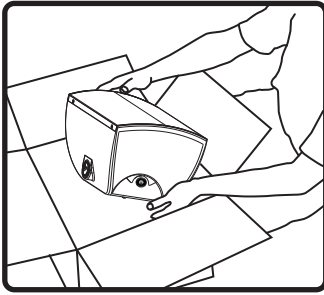

1. Unpack speaker and mounting hardware.

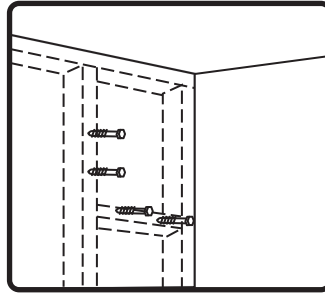

2. Choose a secure mounting surface with sufficient strength to reliably hold the speaker. The speaker may be mounted in either the vertical or the horizontal position with the same U-bracket.

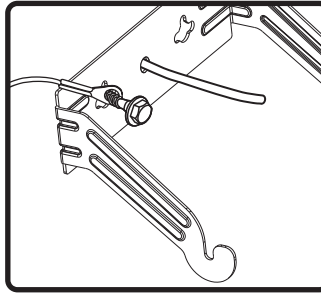

3. Mount u-bracket with clamping slots pointing upward. Securely fasten mounting bracket and safety cable to surface (user must supply fasteners).

Note: The safety cable will attach to one of the speaker's unused mounting holes using one of the included mounting screws.

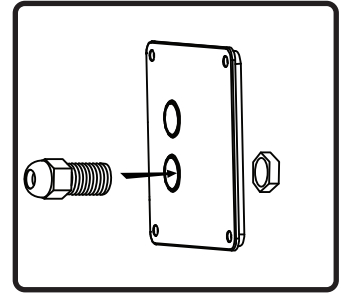

4. Place strain relief gland in one of the knockouts on the back plate and securely fasten the gland nut on the other side.

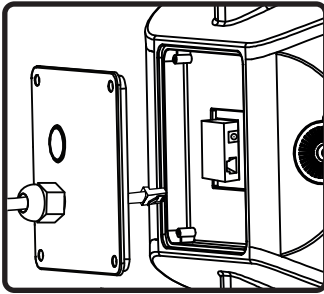

5. **RJ-45 must be terminated after CAT cable is run through the water tight gland.** Run signal wire through the strain relief gland and terminate RJ-45 connector. Once the connection is secure, connect the signal wire to the back of the speaker and tighten the top of the wire gland such that the rubber grommet is tight around the cable. This may require a wrench.

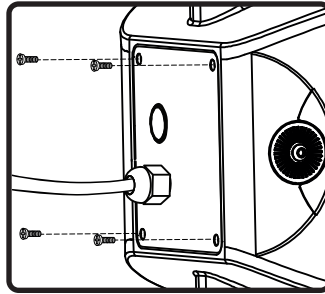

6. Install back plate and secure with included fasteners.

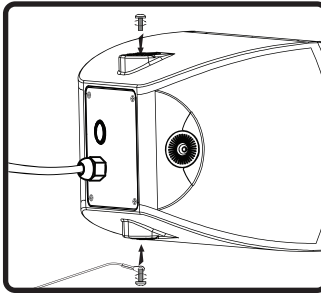

7. Select desired location for safety cable install using U-bracket mounting screw. If mounting speaker horizontally, attach safety cable to one of the vertical mounting points and vice versa.

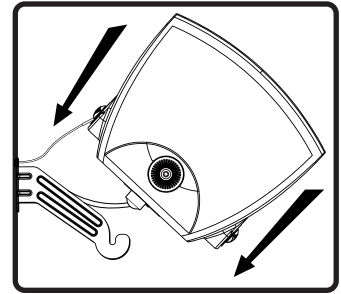

8. Tilt speaker 45° (grille up) and slide on to bracket.

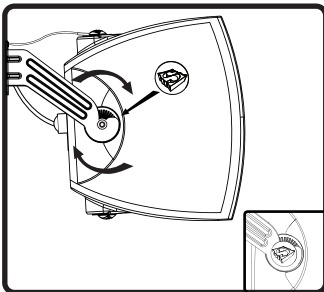

9. Aim speaker and tighten u-bracket screws. In outdoor applications, do NOT angle speaker above horizontal in order to ensure protection from water ingress. Once tightened down, place the screw caps on the screws. Done!

Port protection for SM-EZ

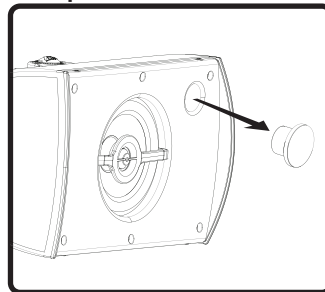

If used indoors, remove the grille and take the plug out of the port for greater bass output. Port must remain plugged to maintain IP65 rating in outdoor use.