



Preliminary Specifications: LA880i-II with LA808i-II

Mounting hardware not included

System Type	LA880i-II plus LA808i-II for extended low frequency directivity control
Impedance (Rated) ¹	4 ohm
Sensitivity dB @ 2.83V / 1 m	90.0 dB
Sensitivity dB @ 1 W/1 m ²	87.0 dB
Frequency Response (-3 dB) ³	83 Hz - 22 kHz
Frequency Response (-10 dB) ³	75 Hz - 22 kHz
Max. Program Power ⁴	500 W
Max. Continuous Power ⁵	300 W
Max. SPL dB @ 1 m ⁶	112 dB
Coverage Angle (-6 dB @ 2 kHz)	103° horizontal 29° vertical
Coverage Angle (-6 dB @ 10 kHz)	77° horizontal 51° vertical
Coverage Angle (Avg. 2 to 10 kHz)	90° horizontal 60° vertical (200-10k)
Directivity Factor (Q)	9.1
Directivity Index (DI)	12.6 dB
Low-Frequency Driver	16- 102mm (4.5 in) woofers, paper with rubber surround
Mid-Frequency Driver	8- 51mm (2.0in) mid range, paper with foam surround
High-Frequency Driver	63.5 mm (2.5 in) planar magnetic ribbon tweeter
Low-Frequency Voice Coil	25.4 mm
Crossover Frequency	500.0 kHz
Network Type: Low-Pass	12dB/oct
Network Type: High-Pass	12dB/oct
Enclosure Material	Painted mdf and plywood
Grille	Powder coated steel
Inputs	4 Pin, 5.08 mm Euroblock or SpeakOn for individual or daisy chain connection
Colors	Black or white
Height	81.8 in. / 2077.8 mm
Width	8.24 in. / 209.3 mm
Depth	10.8 in. / 274.3 mm
Weight	33.9 kg (74.5 lbs)
Shipping Weight	40.9 kg (90.0 lb)
Included Accessories	2 Bent back brackets, 2 Safety cables, 2 Euroblock connectors, Jumper cable, 2 Link plates
Optional Accessories	AC-LA8-BACK, AC-LA8-LINK-II, AC-LA8-FLY-II
Packaging	1 per box, 2 boxes
Regulatory - CE	Approved
RoHS	Approved

Key Features

- Passive, fixed length, low frequency directivity element for SoundTube Line Array.
- Designed for use only with LA880i-II Line Array.
- Eight 4.5 inch (115 mm) woofers.
- Extends low frequency directivity of line array systems by up to an octave lower than with the LA880i-II alone.
- Paintable enclosure is constructed of MDF and plywood with metal threaded mounting points.
- Powder coated, paintable steel grille.
- Available in black or white paint finish.
- Custom woodgrain cabinets or paint finishes available (contact us for details)
- Flexible mounting options include surface-mount, pole-mount, ceiling-mount or suspended (flown). (Allen Products mounting accessories sold separately).
- Euroblock and SpeakOn connectors allow for fast connections and easy daisy chaining.
- Included accessories: safety cable mounting plate and mounting bolts, Euroblock connector, safety cable.
- NOTE: Mounting brackets not included.

Description

NOT a subwoofer, the SoundTube LA808i-II is designed to increase the directivity of low frequencies in SoundTube's Line Array system. It can be used only in conjunction with the LA880i-II 3-way line array. The use of the LA808i-II is recommended in spaces that have a large reverberation time. When a single unit is added to the LA880i-II, directivity of low frequencies is increased by up to an octave lower than with the LA880i-II alone. The product's dimensions are identical to those of the LA880i-II. The LA808i-II must be placed either directly above or directly below the LA880i-II in order for the system to work properly. If desired, two LA808i-II units can be added: one above the LA880i-II and one below.

¹ Impedance listed per IEC 60268-5

² 1w1m sensitivity determined using nominal impedance

³ Frequency response measured in half or full space as dictated by speaker mounting configuration

⁴ Max program power is 3 dB above max continuous power

⁵ Continuous power rating, EIA-426-B test

⁶ Max output based on max continuous power

⁷ Max useable SPL based on testing by NWAALabs



Applications

In combination with the 3-way LA880i-II, the LA808i-II LFDE is ideal for PA and sound reinforcement applications. The system's near-field to far-field transition occurs at only 3 meters (about 10') from the speakers, maintaining a constant directivity of 40 x 120 degrees throughout the coverage area. The LA880i-II and LA808i-II were designed to use in transportation platforms, airports, houses of worship, auditoriums, and other public gathering spaces. The LA880i-II and LA808i-II are not weatherized and are intended only for indoor applications.

Patented SoundTube Technologies

SoundTube Entertainment and MSE Audio are constantly developing new technologies that enhance audio product performance. SoundTube Entertainment innovations are protected by multiple U.S. and international patents, which explicitly cover SoundTube dome, enclosure, and dispersion technologies. MSE Audio actively defends its patents in order to protect SoundTube resellers and end users.

Technical Data and Specification Tools Technical Data

SoundTube Entertainment strives to provide complete and effective technical information and data to dealers, engineers and designers. All data is available from SoundTube Entertainment or at www.soundtube.com.

Technical data and downloads include:

Ease™ data - 3-D polar plots

EASE™ Address - 2-D modeling for distributed systems

Autodesk® Revit® software

Tech Sheets - Technical information and architectural specs for system engineers

SoundTubeSPEC™ - Proprietary speaker placement software.

Data Acquisition

All data for SoundTube speakers is independently collected from and verified by third party labs. All data is collected and analyzed according to ASTM, ISO, and AES standards using EASERA, TEF, and MLSSA. Full balloon data including both phase and magnitude is compiled into a variety of formats including EASE 4.x, GLL, and CLF.

Architectural Specifications

The loudspeaker (LFDE unit) shall be used to enhance the low frequency directivity of a single cabinet with eight 4.5 inch (115 mm) woofers. The cabinet shall be the same size as the cabinet housing the 3-way line array.

In tandem with the 3-way line array, the performance specifications of a typical production LFDE unit shall be as follows: usable frequency response shall extend from 75 Hz - 22kHz (-10 dB). Measured sensitivity (ref. 2.83 V / 1 m) shall be 95 dB. The speaker shall have a rated impedance of 4 ohms. Rated power handling shall be 500 watts and maximum continuous output at 1 meter shall be 112 dB.

The eight low frequency drivers shall include a treated paper cone and butyl rubber surround. They shall use a die cast aluminum basket and a ferrite motor structure. The midrange drivers shall include a treated paper dome with pressed foam surround. They shall use a die cast aluminum basket with a neodymium motor structure. The high frequency driver shall be a planar magnetics (ribbon) unit with a neodymium motor structure.

Mounting points for wall mount, pole mount, ceiling mount or suspension via cables shall be provided. Mounting hardware shall be Allen Products or equivalent. Input connectors shall include a four-position terminal block and Neutrik SpeakOn. The four-position terminal block shall accept from 10 - 22 gauge wire. A jumper cable shall be provided to connect the LFDE unit to the 3-way line array. Built-in low frequency equalization shall automatically be applied to both the LFDE unit and 3-way line array when the two units are properly connected together using the jumper cable.

The enclosure shall be constructed of MDF and plywood with metal ¼" x 20 threaded inserts mounting points and a steel grille. The enclosure and grille shall be available in black or white textured paint, and shall also be paintable by the installer. A bent back plate with plate mounting hardware and safety cable attachment point shall be included. Speaker mounting brackets and hardware shall be available for use with 3rd party manufacturer mounting systems.

The system shall be the SoundTube LA808i-II Low Frequency Directivity Element in conjunction with the SoundTube LA880i-II line array.

SoundTube Entertainment

8005 W. 110th St., Suite 208
Overland Park, KS 66210

Phone 913.663.5600
Fax 913.663.3200
Email sales@mseaudio.com
Website www.soundtube.com



Preliminary Graphs

Frequency Response



Phase/Impedance Response

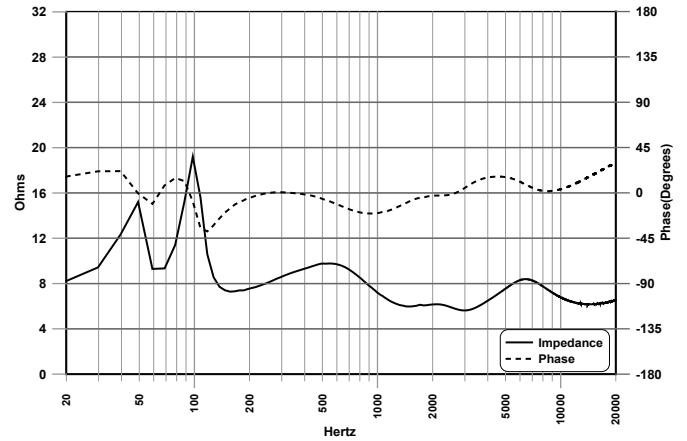

Vertical Beamwidth (-6dB)

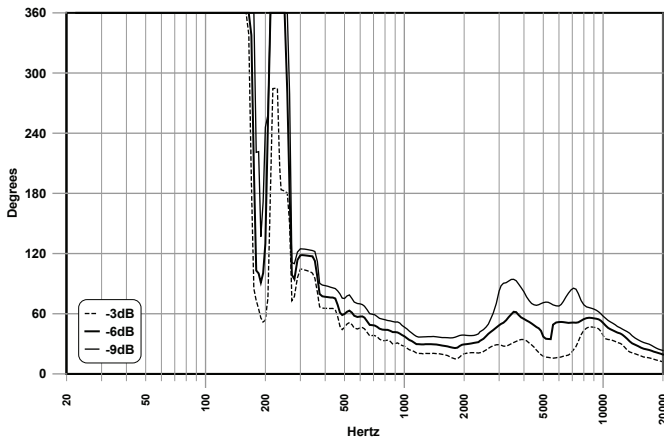

Directivity Index (DI)

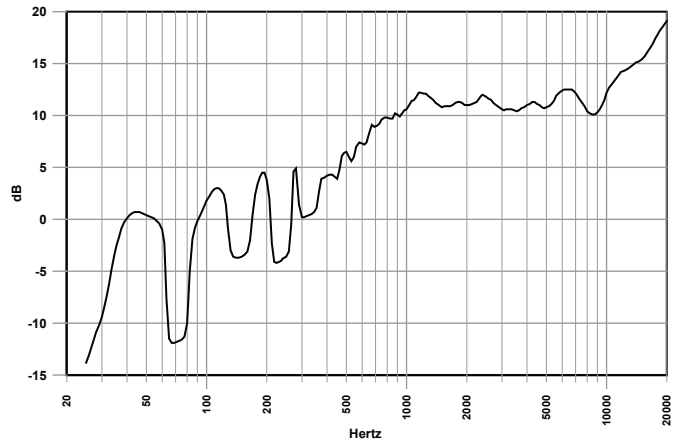

Preliminary Polar Plots

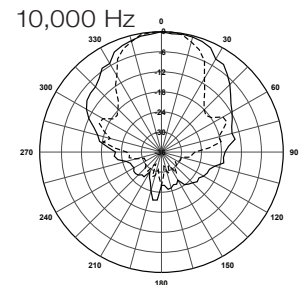
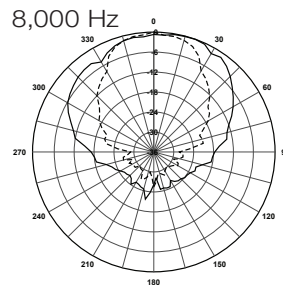
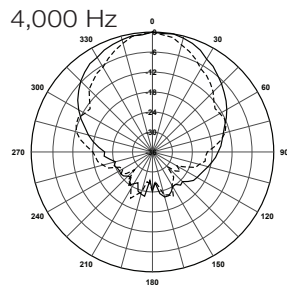
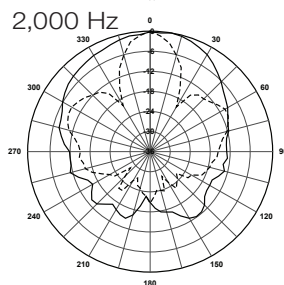
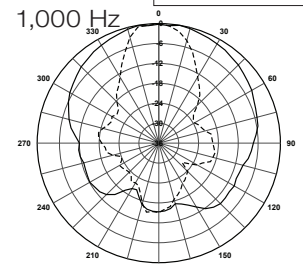
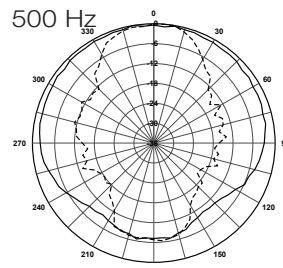
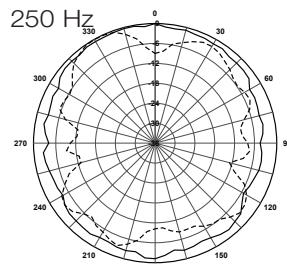
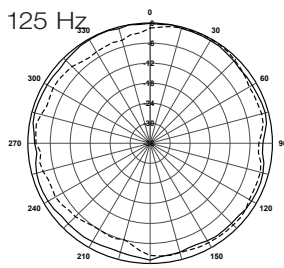



Mechanical Drawings

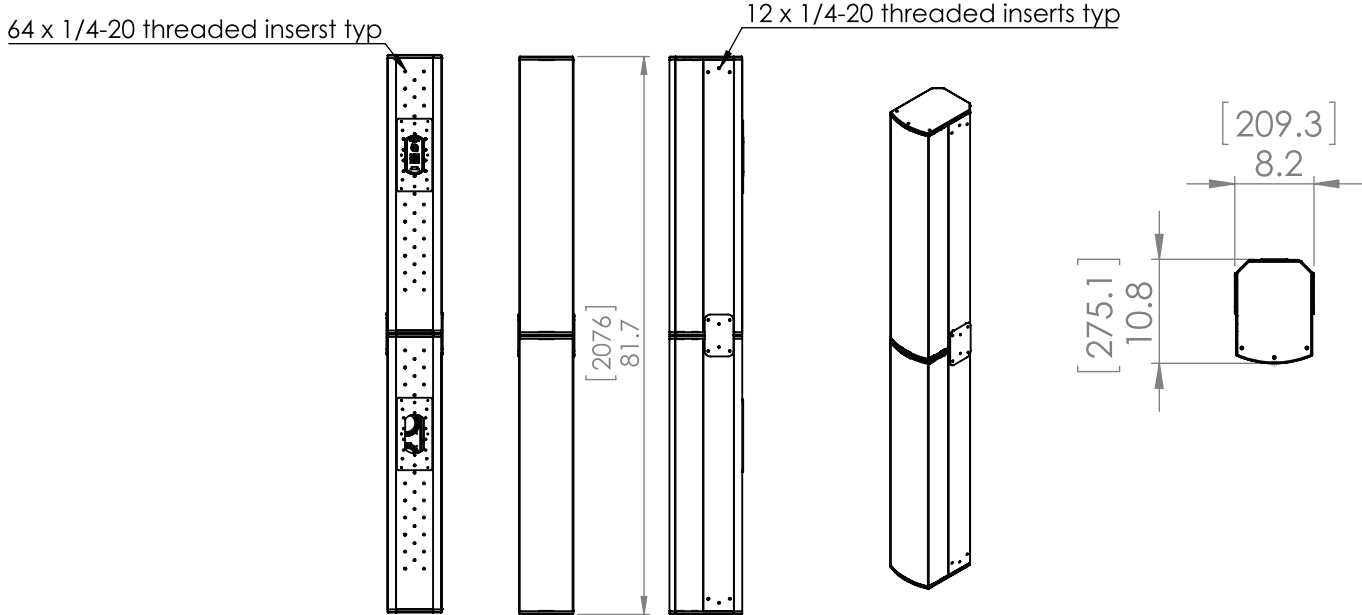

Accessories

	<p>AC-LA8-BACK-BK Bent back plate for LA8 series. Use for safety tie-off, or secondary mounting. Includes 1 bracket and 3 mounting screws. Black only. Comes with LA880i and LA808i. This can also be sold separately.</p>		<p>ST-MM-020X Allen Products ceiling mount bracket kit. Use to hang LA8 system from a secure ceiling. Black only.</p>	<p>ST-TCK-010 Allen Products fly cable kit. Use with ST-1WA-20 and AC-LA8-FLY to suspend LA8 system from above. Only experienced rigging professionals should install the LA8 in a flown configuration. Available in black.</p>
	<p>AC-LA8-LINK-II-BK/WH Side connector plates for LA8 series. Use to link 2 LA8 cabinets, or other top or bottom mount accessories. Includes 2 brackets and 12 mounting screws. Available in black or white. Comes with LA808i and can also be sold separately.</p>		<p>ST-MM-120HD Heavy duty Allen Products pan and tilt surface mount bracket kit. Weight rated up to 120lbs. Use to support up to 3 LA8 cabinets. Black only.</p>	<p>ST-TCK-010-S Allen Products fly cable kit. Use with ST-1WA-20 and AC-LA8-FLY to suspend LA8 system from above. Only experienced rigging professionals should install the LA8 in a flown configuration. Available in silver.</p>
	<p>AC-LA8-FLY-II-BK/WH Top mounted fly point plates for LA8 series. Use to add 2 fly points to the LA8 cabinets. Includes 2 brackets and 6 mounting screws. Available in black or white.</p>		<p>ST-SAS-1WA-20 Allen Products fly bracket. Use with AC-LA8-FLY and ST-TCK-101 to suspend LA8 system from above. Only experienced rigging professionals should install the LA8 in a flown configuration. Black only.</p>	<p>ST-TCK-010-S Allen Products fly cable kit. Use with ST-1WA-20 and AC-LA8-FLY to suspend LA8 system from above. Only experienced rigging professionals should install the LA8 in a flown configuration. Available in silver.</p>
	<p>ST-MM-024 Allen Products pan and tilt surface mount bracket kit. Weight rated for up to 60lbs. Only use with single LA8 cabinet. For multiple cabinets, use ST-MM-120HD. Black only.</p>		<p>AC-RS-HH-10 LA series safety cable kit - 10' safety cable, 2 SpeedClamps & fasteners. Comes with LA880i and LA808i. This can also be sold separately.</p>	<p>ST-TCK-010-S Allen Products fly cable kit. Use with ST-1WA-20 and AC-LA8-FLY to suspend LA8 system from above. Only experienced rigging professionals should install the LA8 in a flown configuration. Available in silver.</p>
	<p>ST-PA-010 Pole mount adapter for Allen Products brackets. Use to adapt ST-MM-024, or ST-MM-120HD for use on a pole. Black only.</p>			

SoundTube Entertainment manufactures a complete line of speakers for:
Open-Ceiling • In-Ceiling • Surface-Mount • Outdoor • Sound-Focusing

All SoundTube products are designed and engineered in the USA.