

[www.fishman.com](http://www.fishman.com)

**FISHMAN<sup>®</sup>**

**USER GUIDE  
LOUDBOX ARTIST**



Whenever this symbol appears, it alerts you to the presence of important operating and maintenance (servicing) instructions in the user's manual for this amplifier.



Wherever this symbol appears, it alerts you to the presence of uninsulated dangerous voltage inside the enclosure that may be sufficient to constitute a risk of shock.



## Important Safety Instructions

To ensure your personal safety and the safety of others, operate this apparatus only after reading these instructions and heeding the warnings listed below.

1. Read these instructions.
  2. Keep these instructions.
  3. Heed all warnings.
  4. Follow all instructions.
  5. Do not use this apparatus near water.
  6. Clean only with a dry cloth.
  7. Do not block the ventilation openings. Install in accordance with the manufacturer's instructions.
  8. Do not install near any heat sources such as radiators, heat registers, stoves or other apparatus (including amplifiers) that produce heat.
  9. Do not defeat the safety purpose of the polarized or grounding-type plug. A polarized plug has two blades with one wider than the other. A grounding-type plug has two blades and a third grounding prong. The wide blade or the third prong are provided for your safety. If the provided plug does not fit into your outlet, consult an electrician for replacement of the obsolete outlet.
  10. Protect the power cord from being walked on or pinched, particularly at the plugs, convenience receptacles and the point where they exit from the apparatus.
  11. Use only attachments/accessories specified by the manufacturer.
  12. Use only with a cart, stand, tripod, bracket or table specified by the manufacturer, or sold with the apparatus. When a cart is used, use caution when moving the cart/apparatus combination to avoid injury from tip-over.
- 
13. Unplug this apparatus during lightning storms or when unused for long periods of time.
  14. Refer all servicing to qualified service personnel. Servicing is required when the apparatus has been damaged in any way, such as a power-supply cord or plug is damaged, liquid has been spilled or objects have fallen into the apparatus, the apparatus has been exposed to rain or moisture, does not operate normally, or has been dropped.
  15. Do not expose the apparatus to dripping or splashing liquids and do not place objects filled with liquids (such as a beverage container or a vase) on the apparatus.
  16. Warning” To reduce the risk of fire or electric shock, do not expose this apparatus to moisture.
  17. The apparatus should be connected to mains outlet with a protective earthing connection.



Disconnect device is Mains Plug, which should remain readily operable.

**Copyright © 2011 FISHMAN TRANSDUCERS, INC.**

All rights reserved. No part of this document may be reproduced in any form without the written permission of FISHMAN TRANSDUCERS, INC.

# INFORMATIONS IMPORTANTES DE SECURITE

- Lisez attentivement ces instructions.
- Veuillez conserver ces instructions.
- Observez tous les avertissements.
- Suivez toutes les consignes à la lettre.
- N'utilisez jamais cet appareil dans un endroit humide ni à proximité d'eau.
- L'appareil alimenté par courant électrique ne peut pas être exposé à des éclaboussures; évite en outre de placer des récipients contenant des liquides, comme un vase (ou un verre de bière), sur l'appareil.
- Nettoyez uniquement l'appareil avec un chiffon doux et sec.
- Ne bloquez jamais les orifices de ventilation de l'appareil et installez-le toujours conformément aux instructions du fabricant.
- N'installez jamais l'appareil à proximité d'une source de chaleur, telle que des radiateurs, poêles ou tout autre dispositif (y compris des amplificateurs) générant de la chaleur.
- N'essayez jamais de contourner le dispositif de sécurité d'une prise de type polarisée ou d'une prise de terre. Une prise dite polarisée dispose de deux broches, dont l'une est plus large que l'autre. Une prise de terre comporte trois broches, dont une de mise à la terre. Cette broche plus large ou broche de mise à la terre vise à assurer votre sécurité. Si la fiche du cordon d'alimentation ne correspond pas au type de prise de courant de votre région, faites remplacer la prise obsolète par un électricien qualifié (pour les Etats-Unis et le Canada).
- Placez toujours le cordon d'alimentation de sorte qu'on ne risque pas de marcher dessus ni de le pincer. Cette précaution vise tout spécialement la fiche du cordon et sa sortie de l'appareil.
- Utilisez exclusivement les fixations/accessoires préconisés par le fabricant.
- S'il y a un risque d'orage ou que vous ne comptez pas utiliser l'appareil pendant une période prolongée, débranchez-le du secteur.
- La mise sur OFF de l'interrupteur d'alimentation n'isole pas totalement ce produit de la ligne secteur; aussi, retirez la fiche de la prise s'il doit rester inutilisé pendant une période prolongée.
- Installez ce produit près de la prise électrique murale et gardez un accès facile à la prise électrique et au cordon d'alimentation.
- ATTENTION: Cet appareil doit absolument être connecté à une prise électrique reliée à la terre.
- Confiez tout travail de réparation uniquement à un S.A.V. qualifié. Faites appel au S.A.V. si l'appareil a subi tout endommagement, comme par exemple si sa fiche secteur ou son cordon d'alimentation sont endommagés, si de l'eau ou des objets ont pénétré à l'intérieur de l'appareil, si celui-ci a été exposé à la pluie ou à la moisissure, s'il est tombé ou présente tout signe de dysfonctionnement.
- N'utilisez jamais d'allonge trop longue avec cet appareil et ne l'alimentez jamais via les prises secteur équipant d'autres dispositifs.
- N'installez jamais cet appareil dans un endroit confiné comme une caisse de transport ou tout autre récipient similaire.
- Des niveaux d'écoute trop importants lors de l'utilisation d'un casque ou d'écouteurs peuvent entraîner des pertes d'audition.
- Utilisez l'appareil uniquement avec le chariot, stand, trépied, fixation ou table spécifiés par le fabricant ou fourni avec l'appareil. Si vous avez placé l'appareil sur un chariot, soyez très prudent quand vous déplacez le chariot, afin d'éviter une chute et des blessures.



**WARNING:**  
TO REDUCE THE RISK OF FIRE OR ELECTRIC SHOCK DO NOT  
EXPOSE THIS PRODUCT TO RAIN OR MOISTURE.

	<b>CAUTION</b> RISK OF ELECTRIC SHOCK DO NOT OPEN	
<b>AVERTISSEMENT:</b> RISQUE DE CHOC ÉLECTRIQUE—NE PAS OUVRIR.		
注意 感電の恐れあり、キャビネットをあけるな		



L'éclair dans le triangle est un symbole destiné à attirer l'attention de l'utilisateur sur la présence de parties non isolées et de "tension dangereuse" à l'intérieur de l'appareil, qui posent des risques d'électrocution pour l'utilisateur.



Le point d'exclamation dans un triangle est un symbole destiné à attirer l'attention de l'utilisateur sur des sections de ce manuel contenant des informations importantes, liées à l'utilisation et à l'entretien de ce produit.

## ATTENTION

Le non-respect de la polarité lors du remplacement de la pile peut poser un risque d'explosion. Remplacez la pile uniquement avec un modèle identique ou équivalent.

### Note concernant les disposition (Seulement EU)

Quand un symbole avec une poubelle barrée d'une croix apparait sur le produit, le mode d'emploi, les piles ou le pack de piles, cela signifie que ce produit, manuel ou piles doit être déposé chez un représentant compétent, et non pas dans une poubelle ou toute autre déchetterie conventionnelle. Disposer de cette manière, de prévenir les dommages pour la santé humaine et les dommages potentiels pour l'environnement. La bonne méthode d'élimination dépendra des lois et règlements applicables dans votre localité, s'il vous plaît, contactez votre organisme administratif pour plus de détails. Si la pile contient des métaux lourds au-delà du seuil réglementé, un symbole chimique est affiché en dessous du symbole de la poubelle barrée d'une croix sur la pile ou le pack de piles.

\* Tous les noms de produits et de sociétés sont des marques commerciales ou déposées de leur détenteur respectif.

# Read Me!

---

Before using Loudbox Artist, carefully read the **Important Safety Instructions** and the **Getting Started** sections in this User Guide.

# Save Your Packing Materials

---

The box and packing materials were specially designed to protect the amplifier during shipping. Save all this stuff in case you need to re-ship the Loudbox Artist.

# Hear This!

---

The Loudbox Artist amplifier is capable of cleanly reproducing the sound of your instrument at very high volume levels. Prolonged repeated exposure to high sound pressure levels (SPLs) without protection can cause permanent hearing loss. OSHA has set guidelines and specified permissible sound-exposure limits for those who work in high SPL environments.

## Permissible noise exposures

Duration per day, hours	Sound level dBA slow response
8	90
6	92
4	95
3	97
2	100
1 ½	102
1	105
½	110
¼ or less	115

To ensure against permanent hearing loss, wear hearing protection when you perform with amplification.



NOTE: Operate the amplifier only at the voltage indicated in the check box on the rear panel. Do not defeat the ground prong on the AC cable; the safe operation of this amplifier depends on a proper ground connection.

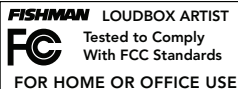



# Welcome

---

Thank you for making Fishman a part of your acoustic experience. We are proud to offer the finest acoustic amplification products available; high-quality professional-grade tools which empower you to sound your very best.



# Getting Started

Here are some basic setup tips to help get you going. To operate the Loudbox Artist safely, please read the entire manual, especially the Important Safety Instructions on page 2.

If your amplifier has an operating voltage of 120V, plug the provided AC line cord into the back of the amplifier.

If your amplifier operates at 230V, you must supply your own detachable power cord. The cord you supply must have an IEC-style 320 connector at one end and a male AC plug appropriate for your area at the other.

1. Locate the Power switch (above the rear panel power cord terminal) and switch it off (down position), then connect the power cord.
2. Plug the Loudbox Artist into an electrical outlet with the appropriate AC voltage.
3. Turn down the **Master Volume** control and turn on the **Power** switch.
4. Connect your instrument to the Channel 1 input with a shielded ¼" cable.
5. Play aggressively and raise Channel 1 **Gain** until the Clip LED (inside the **Pad** button) flashes, then back off the **Gain** until no clipping occurs.
6. Set the tone controls "flat" as illustrated below.
7. Push the **Mute** switch (turning off its yellow light) and slowly raise the **Master Volume** to the desired level.

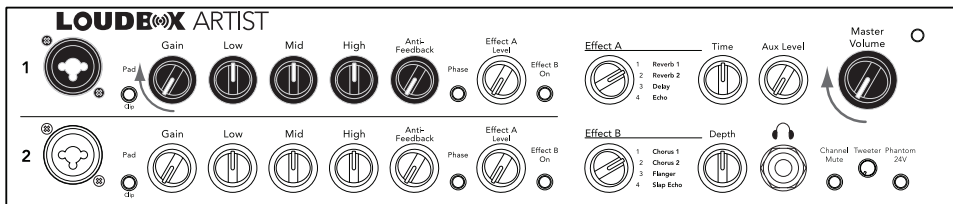

# Front Panel

Controls 1 through 10 are identical for both channels.

## 1. Channel 1 Input

The 1/4" input accepts all types of passive or active acoustic pickups. Plug a balanced mic into the XLR input for vocal or instrument use.

## 2. 10dB Pad & Clip LED

If you have a high output pickup and the Clip LED (located in the center of the Pad button) comes on at low Gain settings, push this switch in to put your pickup level into a more useable range.

## 3. Gain

Use the Gain knob to set the level of the signal.

## 4. Low

Boost here to add weight to the sound. In general, boost bass at low volumes and flatten it out (or cut) at higher levels. With the dial set at 12 o'clock, the control is effectively out of the circuit.

## 5. Mid

This control affects how well the instrument blends in or stands out in the mix. At loud volumes a midrange cut will achieve a more natural sound. With the dial set at 12 o'clock, the control is effectively out of the circuit.

## 6. High

Boost highs to add "air" to the sound of the instrument. With the knob set at 12 o'clock, the control is effectively out of the circuit.

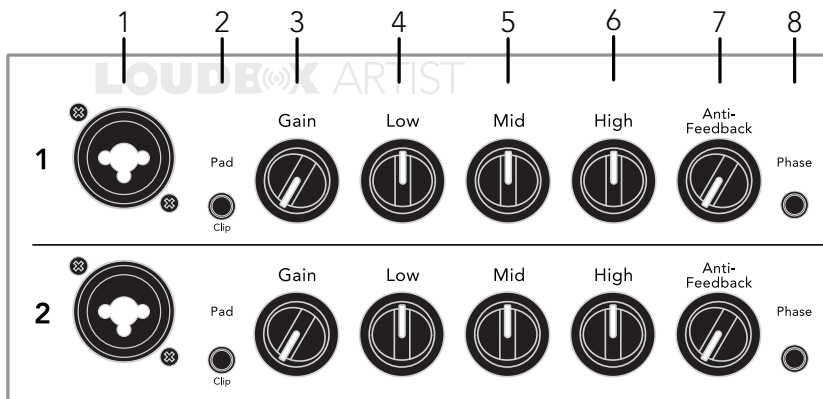



# Front Panel (cont.)

## 7. Anti-Feedback

If you encounter low-frequency feedback, sweep this control to isolate and eliminate it. To learn more about acoustic feedback, see page 9.

## 8. Phase

Use the Phase switch in conjunction with the Anti-Feedback filter to eliminate acoustic feedback. To read more about acoustic feedback, see page 9.

## 9. Effect A Level

Controls the amount of Effect A in the input channel.

## 10. Effect B On

When this button is lit, the input channel's audio is processed by Effect B.

## 11. Effect A

Use this control to select one of four effects for Effect A.

## 12. Effect A "Time"

Determines the length of time for the delay or reverb effects.

## 13. Effect B

Use this control to select one of four effects for Effect B.

## 14. Effect B "Depth"

Adjusts the intensity of Effect B.

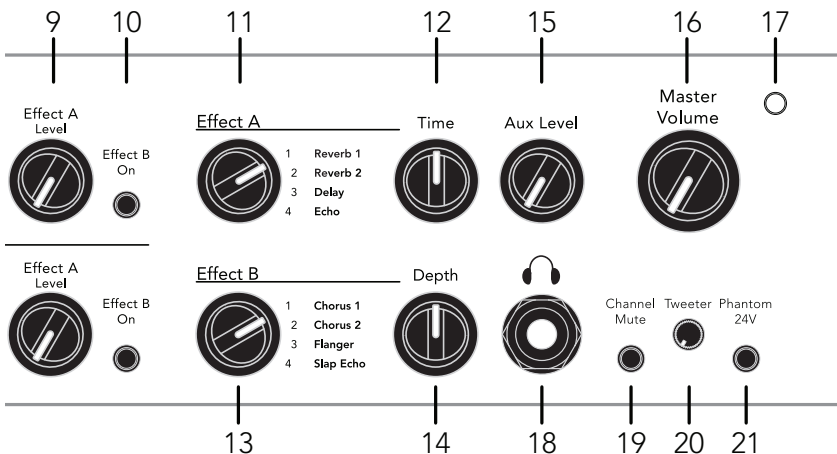

## Front Panel (cont.)

---

### 15. Aux Level

Use this to control the level of an audio device plugged into the Aux input. Note that the Aux channel is independent of the Mute switch, so you can play pre-recorded music on your breaks.

### 16. Master Volume

Set the overall level of the Loudbox Artist with the Master Volume. In general put the Master Volume as high as possible (2 o'clock to 5 o'clock) to achieve the cleanest sound.

### 17. Power

Lights up when the amplifier power is on.

### 18. Headphone Jack

When you plug in stereo headphones here, the speakers shut off. This output monitors Channels 1 & 2 and the Aux input, so you can play along with pre-recorded music through the headphones.

### 19. Channel Mute

The Channel Mute switch shuts off the signals from Channels 1 and 2 to the speakers and all XLR outputs. The Channel Mute does not affect the Aux Inputs or the effects sends. When mute is active, its button LED will be lit.

### 20. Tweeter Level

Turn this control to attenuate the tweeter's output level to where it sounds best to you.

### 21. Phantom Power

Provides 24V to the XLR input on each input channel to power a condenser microphone. When phantom power is active, its button LED will be lit.

Most condenser and dynamic microphones, as well as some preamps, can be used safely with phantom power.

However, phantom power can damage some audio devices including some unbalanced mics, preamps or stompboxes that have been modified for balanced XLR use. Whenever there is doubt, contact the manufacturer to confirm compatibility.



# Rear Panel

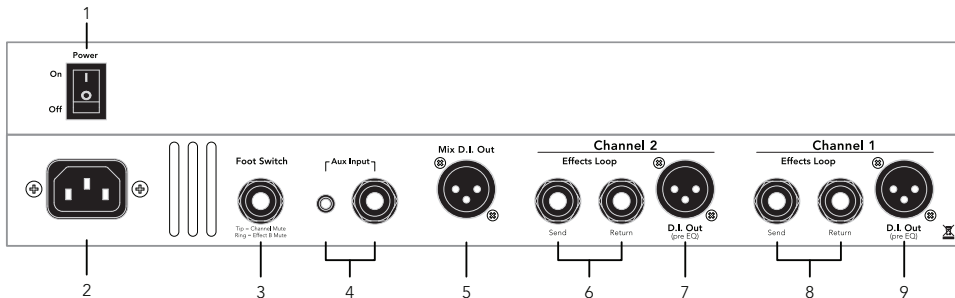

## 1. Power switch

Lower the Master Volume before you turn on the amp. Flip the power switch to the up position.

## 2. AC power

Operate the amplifier only at the voltage indicated on the rear panel.

For 120V amplifiers purchased in the USA, Canada and Mexico, plug in the supplied detachable AC power cable.

For 100V and 230V amplifiers purchased outside the USA and Canada, you will need to supply your own detachable AC cable. This cable must have an IEC-style 320 connector at one end, and a male AC plug appropriate for your region at the other.



Disconnect device is AC inlet or power switch.

## 3. Mute Foot Switch

Plug a Fishman dual foot switch into this jack for remote access to Channel Mute and Effect B Mute.

## 4. Aux Input - 1/4" & 1/8"

Plug in a line level stereo audio source such as a CD or MP3 player in either input. Both inputs may be used at the same time. They are stereo (TRS) inputs, however the left and right signals are mixed to mono.

## 5. Mix D.I. (Post)

Plug in here when you wish to send signals from both Channel 1 and 2 to a mixing console or a slave amplifier. This post-EQ output is always ground isolated to prevent ground loop hum.

## Rear Panel (cont.)

---

### **6. Channel 2 Effects Loop (serial)**

Patch an external effect through these jacks. Use a standard ¼" shielded instrument cable to connect the Channel 2 Send to the input of the effect. Connect the Channel 2 Return jack to the output of the effect. The Channel 2 loop is located post-EQ and is compatible with battery-operated stompbox-style effects processors.

### **7. Channel 2 D.I. Out (Pre-EQ)**

Use this output when you want a flat D.I. signal to send to a mixing console. This pre-EQ output is always ground isolated to prevent ground loop hum.

### **8. Channel 1 Effects Loop (serial)**

Patch an external effect through these jacks. Use a standard ¼" shielded instrument cable to connect the Channel 1 Send to the input of the effect. Connect the Channel 1 Return jack to the output of the effect. The Channel 1 loop is located post-EQ and is compatible with battery-operated stompbox-style effects processors.

### **9. Channel 1 D.I. Out (Pre-EQ)**

Use this output when you want a flat D.I. signal to send to a mixing console. This pre-EQ output is always ground isolated to prevent ground loop hum.

# Tone Tips

## Set up

For reference, start with the tone controls flat (straight-up, twelve o'clock). In this position, there is no equalization applied to your sound. Begin at a very low volume and work your way up. As you turn up, try adjusting the Loudbox Artist's tone controls as recommended below.

### 1. Low volume

At a low volume (just above conversation level) our ears are not very sensitive to bass and treble, so give the Low and High controls a good boost.

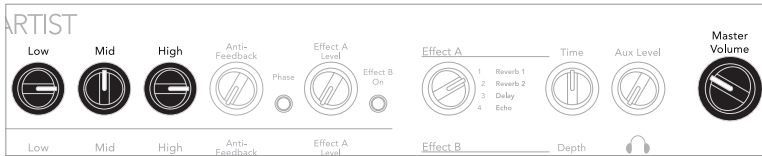

### 2. Medium volume

At intermediate levels, when you need to raise your voice to be heard over the music, the human ear is quite sensitive to midrange. Cut the Mid control to about ten o'clock or to your taste. At this level our perception of bass and treble starts to catch up to the rest of the tonal spectrum, so you can back off the Low and High controls slightly for good tonal balance.

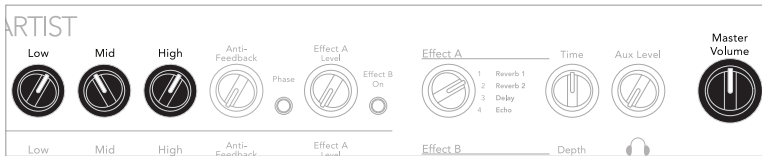

### 3. High volume

At loud levels, when you must shout to be heard over the music, your ears (and your audience) will benefit from a deep midrange cut. Set the Mid dial between nine and seven o'clock. Our perception of bass and treble "flattens out" at high volumes, so you won't need much, if any, Low or High boost. Set the Low and High knobs to between twelve and one o'clock.

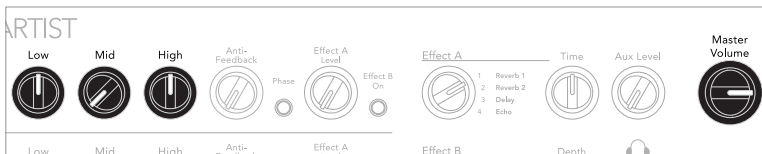

# About Acoustic Feedback

---

Feedback usually occurs in the lowest octave of your instrument, generally with two notes about a half step apart. The lower type of feedback (cavity resonance) starts when the sound pressure coming out of the speakers excites the resonant air chamber inside your instrument. We have found that it is effective to tune out an instrument's cavity resonance feedback with the Anti-Feedback (notch filter) in the Loudbox Artist. For acoustic guitar this occurs at G# on the low E-string, or at about 100Hz. Turn the Anti-Feedback knob to about 11 o'clock to dial out this resonance. Note that the circuit can be effectively defeated by moving the dial to the Off (7 o'clock) position.

The higher range of feedback (top resonance) usually starts about a half or whole step above cavity resonance of the instrument. Top resonance feedback happens when the sound pressure coming off the speakers excites the resonant frequency of the soundboard of your instrument. For acoustic guitar, this occurs at A and above on the low E-string. Push the Phase switch in and out until you find the position that subdues top resonance feedback.

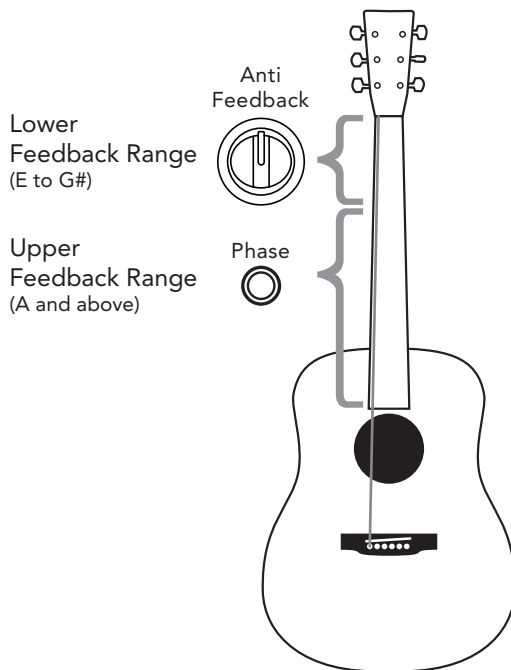

# Block Diagram

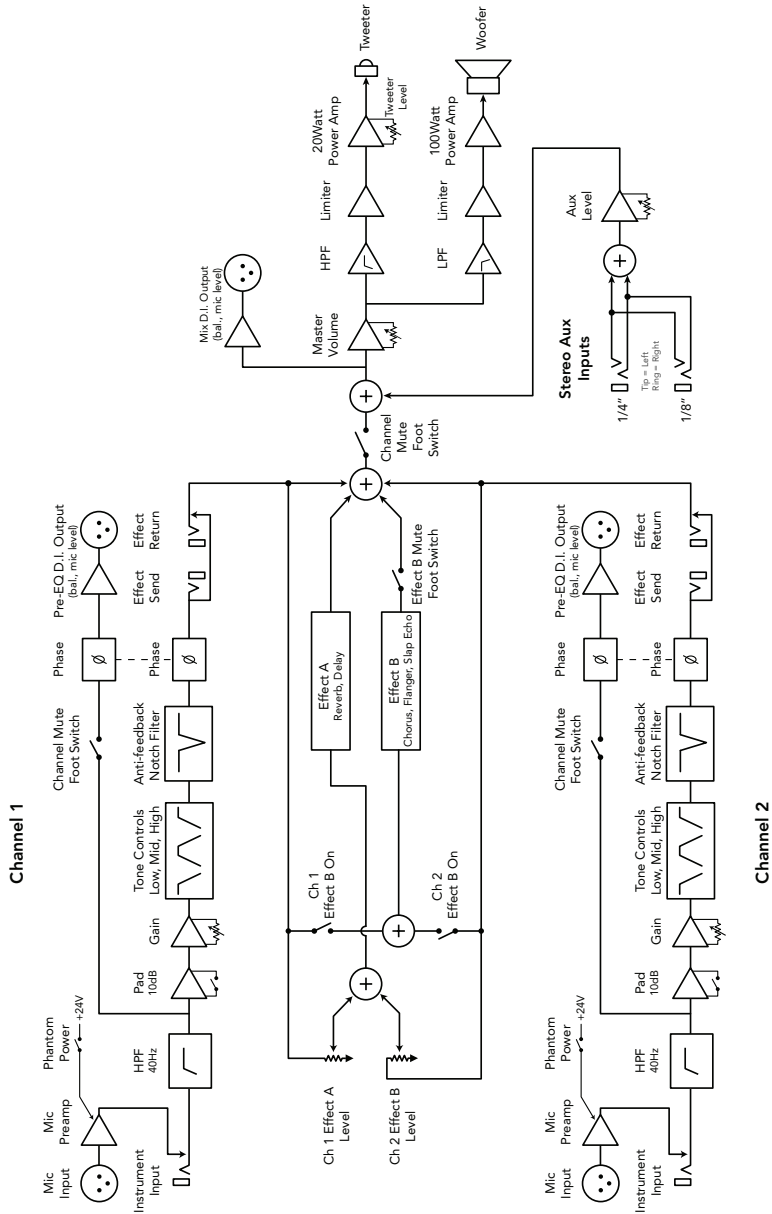





# Technical Specifications

---

## Input Impedance:

1/4" Input	5M $\Omega$
XLR Input	2.4k $\Omega$ Balanced
Aux Input (stereo)	10k $\Omega$

## Phantom Power

XLR Input	24VDC / 1.2k $\Omega$ DC source impedance per pin
-----------	---

## Tone Controls and Anti-Feedback:

Low	$\pm 12.5$ dB @ 50Hz (resonant)
Mid	$\pm 10.5$ dB @ 750Hz (resonant)
High	$\pm 12.5$ dB @ 15kHz (shelving)
Anti Feedback range	-14dB @ 15Hz – 330Hz (Hi-Q resonant notch)

## Channel 1 & 2 D.I. Output:

Output Impedance	440 $\Omega$ balanced
Phantom power tolerant, ground isolated	

## Channel 1 & 2 Effects Sends:

Output Impedance	2.2k $\Omega$
Operating Level	-10dBV Nominal

## Channel 1 & 2 Effects Returns:

Input Impedance	28k $\Omega$
Input Voltage	-10dBV Nominal

(Sends and returns are compatible with battery operated effects processors)

## Mix D.I. Output:

Output Impedance	600 $\Omega$ balanced
Phantom power tolerant, ground isolated	

## Technical Specifications (cont.)

---

### Speaker System:

Woofer	8" paper cone, acoustic suspension
Tweeter	1" cloth dome, neodymium magnet
Tweeter Level	Up to 6dB cut
Crossover	3.5kHz (Bi-amplified with active crossover)
Baffle Angle	10 Degrees

### Rated Power:

Cumulative	120Wrms
Woofer Amp	100Wrms continuous
Tweeter Amp	20Wrms continuous
SPL @ 1 Meter	113dB SPL
Frequency Response	80Hz – 20kHz (-4dB)

**Power Consumption:** 150W max

**Fuse Rating:** 100V, 50/60Hz: T2AL 250V (2A slow-blow, 5x20mm)  
120V, 50/60Hz: T2AL 250V (2A slow-blow, 5x20mm)  
240V, 50/60Hz: T1AL 250V(1A slow blow,5x20mm)

### Physical:

Dimensions	13.5" H x 15.5" W x 11.5"D (343mm x 394mm x 292mm)
Weight	25.5 lbs (11.6 kg)

We reserve the right to change any of the the specifications and information in this manual without notice.

***FISHMAN***

[www.fishman.com](http://www.fishman.com)