



PURERESONANCEAUDIO[®]

RMA240BT MIXER AMPLIFIER

INSTALLATION AND OPERATION MANUAL



Caution: Please read this manual carefully before operating.
Damage caused by misuse is not covered by the warranty.

SAFETY PRECAUTIONS

- Be sure to read the instructions in this section carefully before use.
- Please carefully follow the safety symbols and messages in this manual, as they include important precautions to ensure your safety.
- We also recommend you keep this instruction manual handy for future reference.

SAFETY SYMBOL AND MESSAGE CONVENTIONS

Safety symbols and messages described below are used in this manual to prevent bodily injury and property damage which could result from mishandling. Before operating your product, read this manual first and understand the safety symbols and messages so you are thoroughly aware of the potential safety risks.

 **WARNING!** Indicates a potentially hazardous situation which, if mishandled, could result in death or serious personal injury.

 **CAUTION!** Indicates a potentially hazardous situation which, if mishandled, could result in moderate or minor personal injury, and/or property damage.

 **WARNING!**

WHEN INSTALLING THE UNIT

- Do not expose the unit to rain or an environment where it may be splashed by water or other liquids, as doing so may result in fire or electric shock.
- Use the unit only with the voltage specified on the unit. Using a voltage higher than what is specified may result in fire or electric shock.
- Do not cut, bend, damage or modify the power cord. Also avoid using the power cord near heating appliances and never place heavy objects (including the unit itself) on the power cord as this could result in fire or electric shock.
- Be sure to replace the unit's terminal cover after connection is complete. Because high voltage is applied to the speaker terminals, never touch these terminals to avoid electric shock.
- Make sure the equipment is grounded to the safety ground (earth) terminal to avoid electric shock. Never ground to a gas line as this could lead to a catastrophic disaster.
- Do not install or place the unit in an unstable place such as a wobbly table or sloped surface. Otherwise, the device may fall and cause personal injury and/or property damage.

WHEN THE UNIT IS IN USE

- Should any of the following irregularities be found during use, immediately switch off the power, disconnect the power supply from the outlet and contact your nearest dealer. Do not attempt to use the unit in this condition as it may result in fire or electric shock.
 - If you detect smoke or a strange smell coming from the unit
 - If water or any metallic object gets into the unit
 - If the unit falls, or the unit casing breaks
 - If the power supply cord is damaged (exposure of the wires, heat damage, missing prongs, etc.)
 - If the unit malfunctions, such as not producing any tone or sound
- To prevent a fire or electric shock, never open or remove the unit case as there are high voltage components inside the unit. Refer all servicing to your nearest dealer.

- Do not place cups, bowls, or other containers of liquid or metallic objects on top of the unit. If they accidentally spill into the unit, this may cause a fire or electric shock.
- Avoid inserting or dropping any metallic objects or flammable materials into the fan opening on the back of the unit to prevent the risk of fire or electric shock.

CAUTION!

WHEN INSTALLING THE UNIT

- Never plug in or remove the power supply plug with wet hands, as doing so may cause electric shock.
- When unplugging the power supply cord, be sure to grasp the power supply plug; never pull on the cord itself. Operating the unit with a damaged power supply cord may cause a fire or electric shock.
- When moving the unit, be sure to remove its power supply cord from the wall outlet. Moving the unit with the power cord connected to the outlet may cause damage to the power cord, resulting in fire or electric shock. When removing the power cord, be sure to hold its plug to pull.
- Do not block the ventilation slots in the unit's cover. Doing so may cause heat to build up inside the unit and result in fire.
- Avoid installing the unit in humid or dusty locations, in locations exposed to the direct sunlight, near the heaters, or in locations generating sooty smoke or steam as doing otherwise may result in fire or electric shock.

WHEN THE UNIT IS IN USE

- Do not place heavy objects on the unit as this may cause it to fall or break which may result in personal injury and/or property damage. In addition, the object itself may fall off and cause injury and/or damage.
- Before switching on the power, ensure that the volume control is set to the minimum position. Loud noise produced at a high volume when power is switched on can damage hearing.
- Do not operate the unit for an extended period of time with the sound distorting. This is an indication of a malfunction, which in turn can cause heat to generate and result in a fire.
- To prevent a fire or damage to the unit, regularly clean it and ensure that dust does not accumulate over a long period of time. Consult your dealer regarding cleaning.
- To prevent a fire, periodically clean the power supply plug and the wall AC outlet. Ensure that the plug is inserted securely into the wall outlet.
- For safety purposes, switch off the power and unplug the unit from the AC outlet when cleaning or leaving it unused for 10 days or more. Failure to do so may result in a fire or electric shock.

An all-pole mains switch with a contact separation of at least 3 mm in each pole shall be incorporated in the electrical installation of the building.

PLEASE NOTE:

Due to product upgrades, some of the features and specification in this user manual may or may not match the actual functions of the unit.

GENERAL DESCRIPTION

The Pure Resonance Audio RMA240BT 5-channel commercial rack mount mixer amplifier provides quick and easy Bluetooth connection and 240 watts of high-performance Class D power encased in a slim, lightweight, space-saving design. The multimedia player is equipped with inputs for TF cards and USB thumb drives and features a built-in FM tuner. With a forced air-cooling fan and emergency priority capabilities, this compact and affordable mixer amplifier perfectly accommodates the long hours of commercial businesses and reliability needed for public address. The RMA240BT is ideal for offices, schools, restaurants, retail stores, or any background music, paging, or announcement sound system.

FEATURES

- Advanced high-performance amplifier circuit
- 1U chassis, high efficiency, and lightweight design
- 240 Watts of rated power with 4 - 16 Ohm/70V speaker output
- Master volume control, bass and treble tone controls, and individual channel volume controls
- The MP3 media player supports Bluetooth, USB, TF, and FM tuner
- Supports 1 emergency channel input, 2 AUX inputs, and 4 MIC inputs with 1 MIC priority input
- Forced air-cooling fan speeds up as the temperature increases to meet long working hours
- Level, overheating, overload, and short-circuit protection with indicators
- IR Remote control included for the MP3 player with replaceable CR2025 3V lithium battery

SPECIFICATIONS

Rated Power Output	240W
Speaker Outputs	4 - 16Ω/70V
Input Sensitivity	MIC: 5mV±1mV LINE: 350mV±20mV AUX: 350mV±20mV EMC: 775mV±40mV
Pre-Output	AUDIO OUT: 1V±50mV/ 100Ω
Tones	Low frequency: ± 10 dB at 100 Hz High frequency: ± 10 dB at 10 kHz
Frequency Response	80 Hz - 16 kHz +/- 3 dB
S/N Ratio	MIC1, 2, 3, 4: 66dB; AUX1, 2: 85dB
THD	≤0.05%
Indicator	Power, clipping, protection, and signal
Cooling Mode	Variable speed fan for forced air cooling
Protection Modes	Over-heat, overload, short circuit
Operation Temperature	+5°C - +40°C
Storage Temperature	-20°C - 70°C
Relative Humidity	<95% (No condensation)
Voltage	110 - 120V 60Hz
Power Consumption	300W
Remote Control	IR remote control with CR2025 3V lithium battery
Dimensions (H x W x D)	1.73" (44 mm) x 19.05" (484 mm) x 12.4" (315 mm)
Weight	9.04 lbs (4.1 kg)
Shipping Weight	11 lbs (4.99 kg)

REAR PANEL

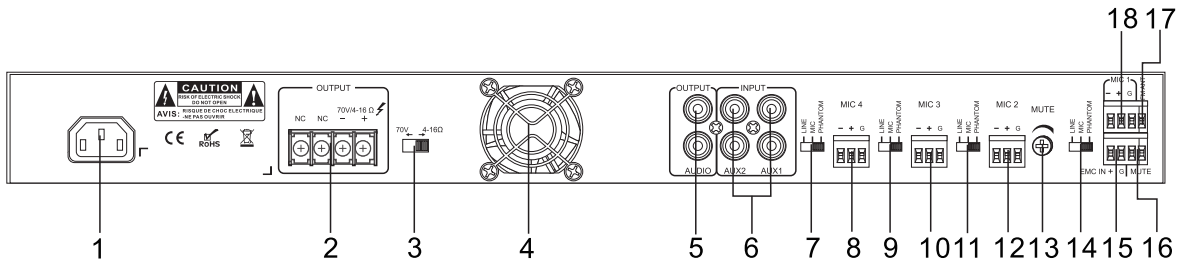

1. AC power input socket
2. 70V/4-16Ω output interface
3. 70V/4-16Ω speaker output switch
4. Cooling fan
5. Line output interface, used to connect the line input interface
6. 2-Channel AUX input interface, used to connect AUX output interface
7. Line input/Mic input/Phantom power switch for MIC4
8. MIC4/AUX1 Balance input
9. Line input/Mic input/Phantom power switch for MIC3
10. MIC3 Balance input
11. Line input/Mic input/Phantom power switch for MIC2
12. MIC2 Balance input
13. MUTE control switch
14. Line input/Mic input/Phantom power switch for MIC1
15. EMC input interface
16. MUTE signal input port
17. FM radio antenna interface
18. MIC1 Balance input

FRONT PANEL

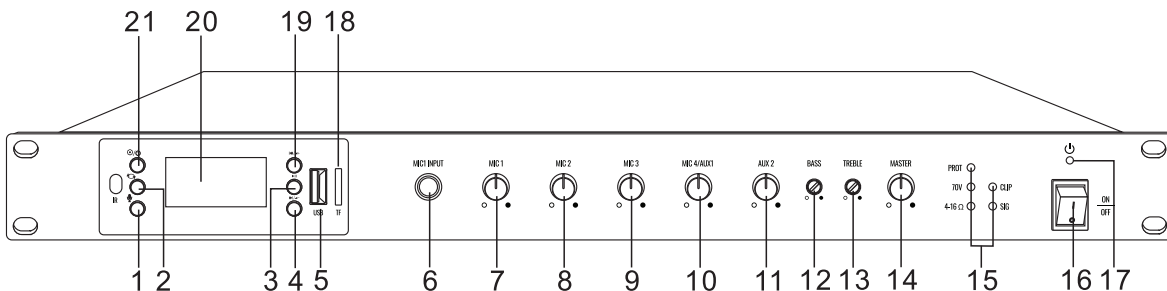

1. Recording function button
2. MP3 loop playback function button
3. Play/Pause
4. Next song/Volume reduce
5. USB interface
6. MIC1 unbalanced input jack
7. MIC1 volume control knob
8. MIC2 volume control knob
9. MIC3 volume control knob
10. MIC4 / AUX1 volume control knob
11. AUX2 volume control knob
12. BASS adjustment potentiometer
13. TREBLE adjustment potentiometer
14. Master volume control
15. PROT/70V/4-16Ω/CLIP/SIG status indicators
16. Power switch
17. Power indicator
18. TF card slot
19. Previous song/Volume up
20. LCD display
21. Mode function button

REMOTE CONTROL

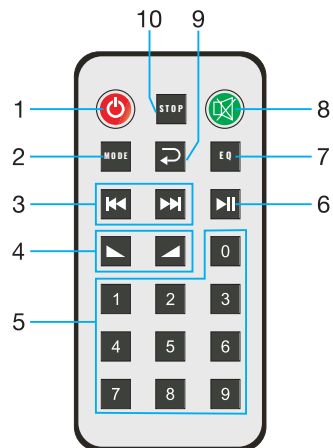

1. Power Button
2. Mode
3. Previous/Next
4. Volume Increase/Decrease
5. 0-9 Number Buttons
6. Play/Pause
7. Sound Effect Control
8. Mute
9. Cycle Play Button
10. Pause

Normal remote control distance: 25 feet

Remote control usage attention:

1. When installing the battery, be mindful of the battery contacts.
2. Point the remote control towards the unit to ensure proper signal reception.
3. Replace the battery if the remote becomes unresponsive or has reduced range.
4. Remove the battery from the remote when not in use for an extended period.
5. Handle the remote with care and avoid dropping it to prevent damage.

OPERATION

CONNECT THE SPEAKERS

With the 70V and 4-16Ω selector switch to 70V position, as shown below:

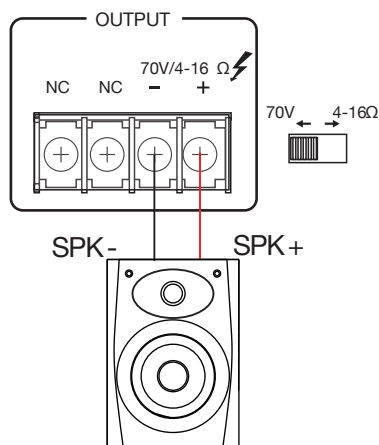

70 Volt speaker: According to the rated power of the power amplifier, adjust the 70V transformer tap accordingly.

With the 70V and 4-16Ω selector switch to 4-16Ω position, as shown below:

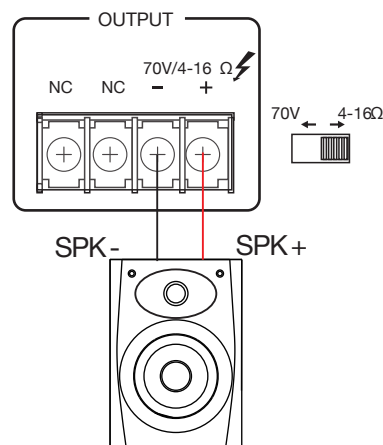

Fixed resistance speaker: 4-16Ω

PLEASE NOTE:

1. Before connecting the speakers, please ensure the equipment is powered off. If the power is on, you may run the risk of electric shock.
2. Please make sure that there is no applied load to the speaker cables.
3. During the installation of speakers, please ensure that the sum of the rated input power of the speakers to be connected is less than the rated power of the equipment.

CONNECT EXTERNAL DEVICES

1. Please ensure that the equipment and all other equipment to be connected are powered off.
2. Use the corresponding cable to connect this equipment and other external equipment.

CONNECT THE POWER LINE AND TURN IT ON

1. Please ensure that the power switch of the equipment and its connected equipment are turned off (in the OFF position).
2. Turn the volume knob to the left.
3. Connect the supplied power line to the AC IN interface.
4. Plug the power line into the applicable socket.
5. Turn on the connected equipment (CD player, etc.), and then turn on the equipment.

PLEASE NOTE:

1. Before powering on, check and ensure there are no problems with the cable connection.
2. When you turn off the system, turn off the equipment and then the connected equipment.

USING A MICROPHONE

1. Turn the volume all the way down (to the left) and connect the microphone and microphone input interface.
2. Speak into the microphone and gradually turn up the volume (to the right) until the output signal is clear and not distorted.
3. If the voice output is too low, increase the volume using the knob until the desired volume is reached.
4. If the speaker volume is too high, reduce the volume using the knob until the desired volume is reached.

SHUTTING DOWN THE SYSTEM





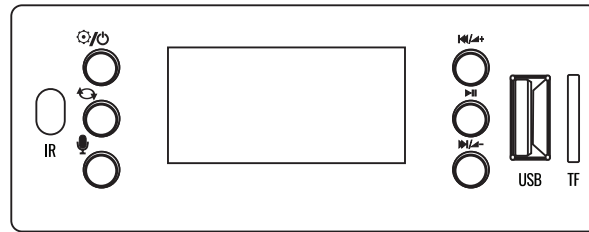

1. Turn the volume knob to the minimum position (fully to the left).
2. Turn the power switch on the front of the amplifier to the "OFF" position. If applicable, also turn off any connected processor and/or audio source equipment.

PLEASE NOTE:

1. When turning off the power switch, please wait about 5 seconds before turning it on again. Continuous rapid turning on and off the power switch will lead to equipment failure.
2. Even when the switch is turned off, a small amount of current may still flow through the equipment. If you won't be using the equipment for an extended period of time, unplug the AC power cord from the wall socket to prevent unnecessary power consumption.

BUILT-IN MP3 PLAYER OPERATION METHOD:



	MODE button: Press to choose FM radio, USB, Bluetooth, or audio playback (press and hold to forcibly turn on/off the amplifier)
	Previous song (press and hold to increase the volume)
	MP3 loop playback button with Repeat One / Repeat ALL / Random / Repeat Folder modes
	Play / Pause (press and hold in FM mode to receive the station)
	Recording button (press in PLAYING mode to record) (press and hold to switch between recording and USB playback)
	Next song (long press to decrease volume)

PLEASE NOTE:

1. Please use caution when pressing the built-in MP3 player buttons to avoid applying excessive force that could damage the button.
2. To avoid damaging the TF card or USB interface, insert them correctly and avoid using excessive force. Incorrect insertion can also cause damage.

USB OPERATION

Press the MODE button to select the USB mode, and copy the MP3 file in the U disk (below 32G). It supports MP3 / WAV / WMA / AEC / FLAC format.

TF CARD OPERATION

Insert a TF card (below 32G) to copy the MP3 file. It supports MP3 / WAV / WMA / AEC / FLAC format.

FM (RADIO RECEPTION) FUNCTION

Press the MODE button to select the FM mode, and then press and hold the PLAY / PAUSE button to receive the radio station automatically. The radio stations received (depending on the sound received) depends on the venue.

Note: Due to the possibilities of FM radio interference and the variables involved, it's not recommended to use FM radio as your primary input source.

MP3 SONG LOOP PLAYBACK

In USB or TF card mode, play a song at will, and press the mode button to switch between Repeat One / Repeat ALL / Random / Repeat Folder.

FUNCTIONAL MEMORY OPERATION

Turn on the amplifier by the remote controller or press and hold the MODE button. After it is turned on, it can remember the function mode selected before. If you unplug the power cable and turn it on again, the default is Bluetooth mode.

VOLUME +/- OPERATION

Long press the Previous Song button on the unit to increase the volume quickly, and long press the Next Song button to decrease the volume quickly.

BLUETOOTH OPERATION

1. Press the Mode button on the remote to ensure the media player is in Bluetooth mode, indicated by the letters "BT."
2. Find and select "PRA-BT" from your device's Bluetooth settings. No password should be required.
3. The device should pair within a minute or so.
4. If pairing is unsuccessful, power down your amplifier and close the settings app on your device.
5. Power up the amplifier and reopen the settings. Repeat the first steps to attempt to pair again. If you still have an issue pairing, please reboot your personal device and cycle the amplifier's power.
6. Once pairing is successful, open the music app. Ensure device volume is turned up to at least 75% capacity on the device.
7. Adjust the volume of the audio player with volume buttons on the infrared remote (OK to set at max volume - 32).
8. Adjust the master volume to the desired level, ensuring the amplifier does not show clip or show any red lights.

OPERATION INSTRUCTION FOR MIC1/ MIC2/ MIC3/ MIC4 INPUT SWITCH

The input switch includes: Line input, Mic input, and Phantom power supply

1. The input switch includes: Line input, Mic input, and Phantom power supply
2. When switching to Line input, you can input the source, such as CD, VCD, DVD, and other external audio equipment.
3. When switching to the MIC input, you can use a dynamic microphone.
4. When switching to PHANTOM, the input interface with a 48V phantom power supply, you can use a condenser microphone.

TROUBLESHOOTING

SYMPTOM	PROBLEM
1. Amplifier is not working	<ol style="list-style-type: none">a. The amplifier is not plugged inb. The power outlet is deadc. The amplifier is in protection mode
2. All lines are connected, but there is no sound	<ol style="list-style-type: none">a. The power switch is not onb. The master volume is turned downc. An individual channel volume is turned downd. The media player volume is turned downe. No audio signal is being playedf. The wiring is incorrect
3. Sound suddenly cuts out during normal usage	<ol style="list-style-type: none">a. The equipment overheated and went into protection modeb. The wiring has a bad connection
4. Low sound levels	The impedance level of the amplifier and speakers do not match
5. Sound is distorted	The input audio level is too high, causing interference

REAR PANEL CONNECTIONS

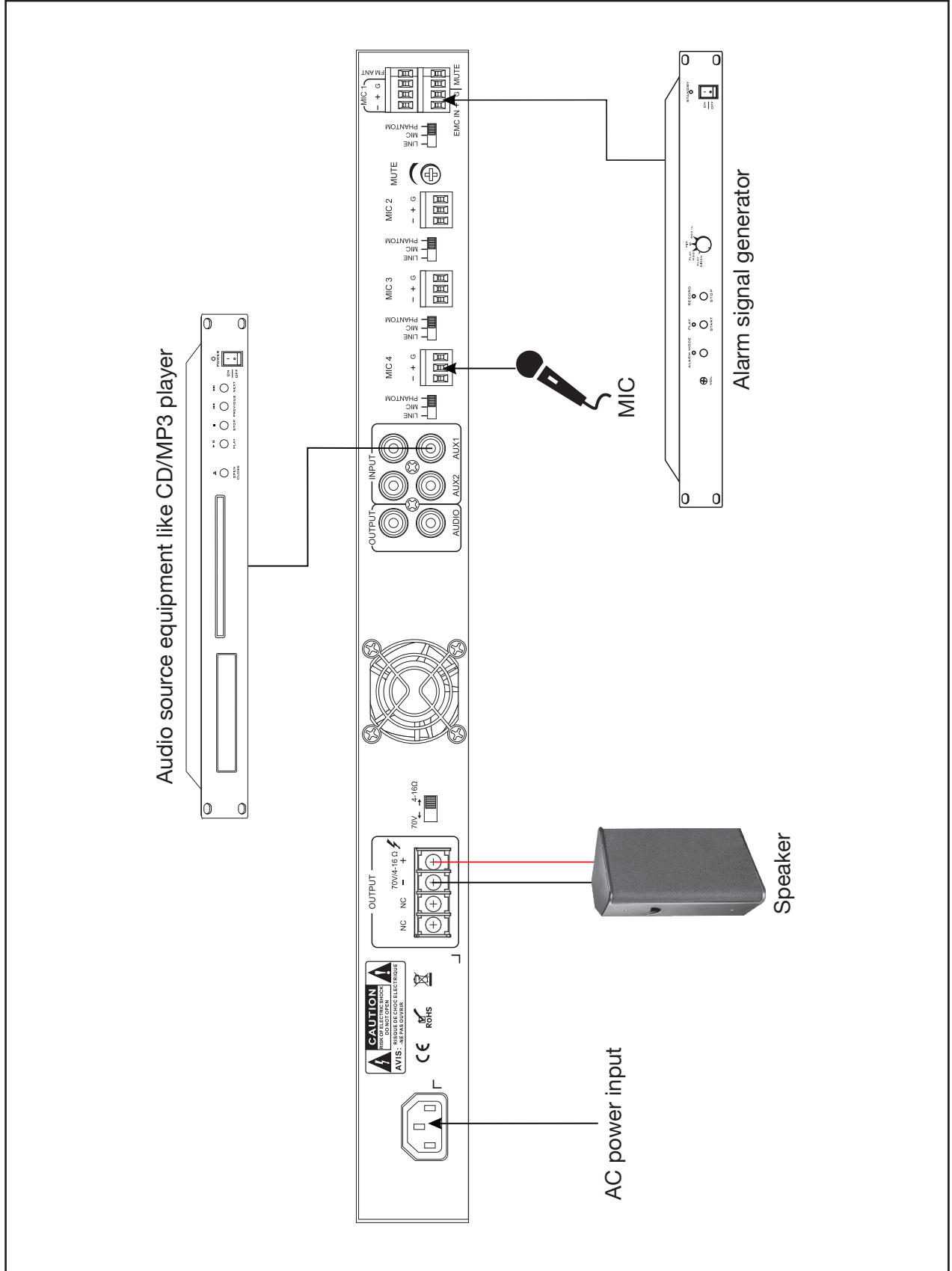

BLOCK DIAGRAM

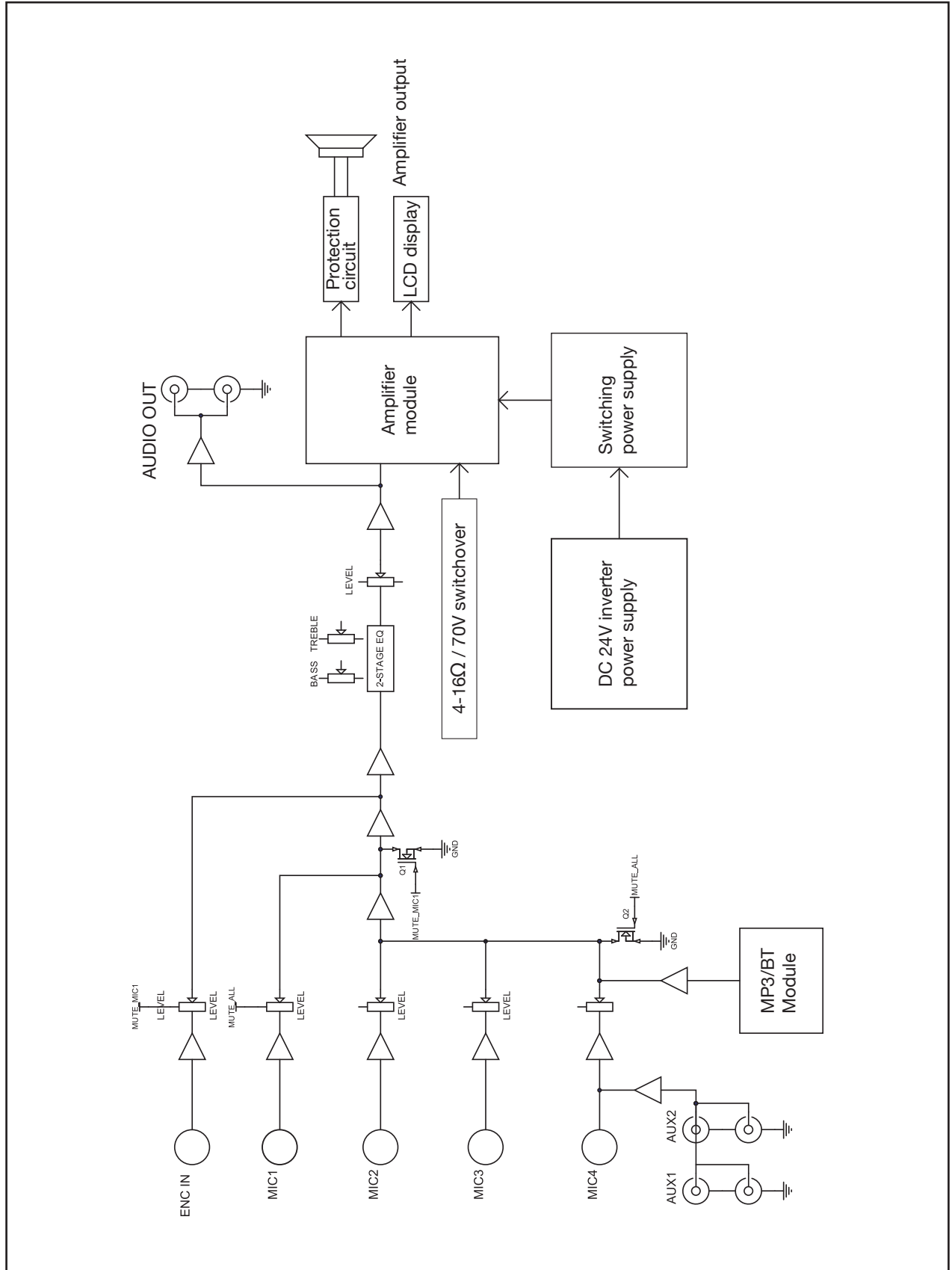

DIMENSIONAL DIAGRAMS

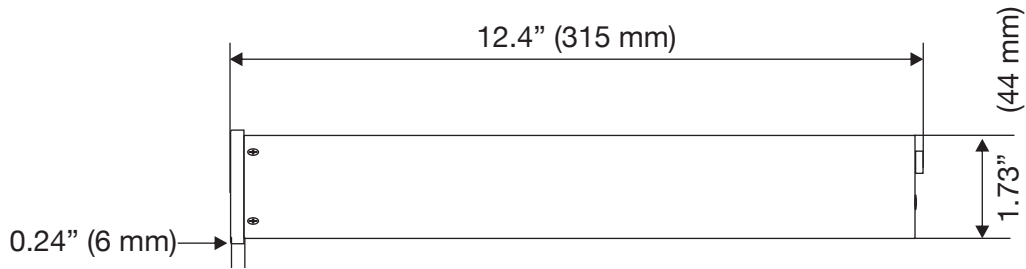
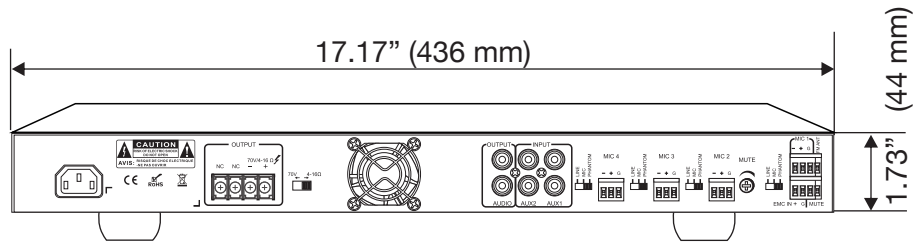
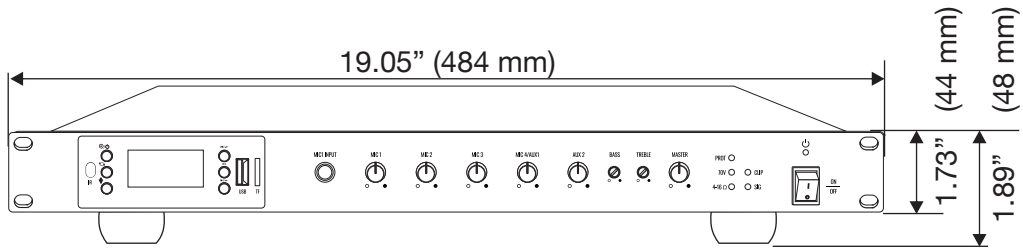

Keep objects at least 4 inches away from the unit as not to obstruct airflow and cause the internal temperature to rise.

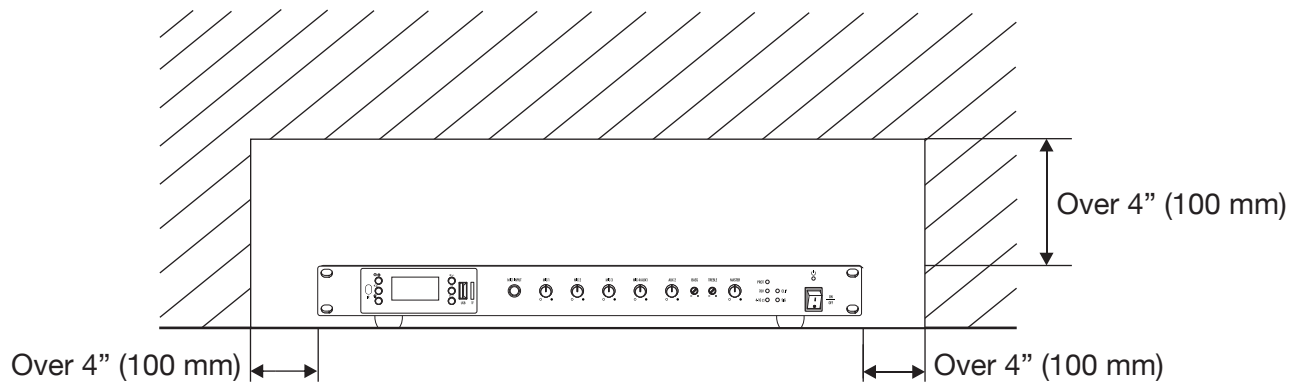

SERVICE

Ensure the problem is not related to operator error, or system devices that are external to this unit. Information provided in the troubleshooting portion of this manual may help with this process. Once it is certain that the problem is related to the product contact your warranty provider as described in the warranty section of this manual.

LIMITED WARRANTY

PRO ACOUSTICS, LLC. ("PRO ACOUSTICS") warrants this product to the original purchaser to be free from defects in materials and workmanship (subject to the terms set forth below), for the following periods from the date of purchase.

THIS WARRANTY COVERS THE LISTED PRODUCTS AGAINST DEFECTS IN MATERIALS OR WORKMANSHIP FOR THE FOLLOWING PERIOD

Warranty Terms	
Speakers	2 Years
Amplifiers & Electronics	1 Year
Microphones	1 Year
Accessories	1 Year

PRO ACOUSTICS will repair or replace (at PRO ACOUSTICS's option) this product or any defective parts (excluding electronics and amplifiers) in this product.

Your authorized PRO ACOUSTICS dealer will inspect the product and, if your dealer is not equipped to perform the repair of your PRO ACOUSTICS product, they will replace your product or return it to PRO ACOUSTICS for repair, at their discretion. Proof of purchase in the form of a bill of sale or receipted invoice, which is evidence that this product is within the warranty period, must be presented to obtain warranty service.

This warranty is invalid if the factory applied serial number has been altered or removed from this product. This warranty is invalid if this product was not purchased from a PRO ACOUSTICS authorized dealer. Cosmetic damage or damage due to the accident, acts of God, misuse, abuse, negligence, commercial use, or modification of, or to any part of, the product are not covered in this warranty. This warranty does not cover damage due to improper operation, maintenance or installation, or attempted repair by anyone other than PRO ACOUSTICS or a PRO ACOUSTICS dealer which is authorized to do PRO ACOUSTICS warranty work. Any unauthorized repairs will void this warranty.

This warranty does not cover products sold as is.

REPAIRS OR REPLACEMENTS AS PROVIDED UNDER THIS WARRANTY ARE THE EXCLUSIVE REMEDY OF THE CONSUMER/PURCHASER. PRO ACOUSTICS U.S.A. SHALL NOT BE LIABLE FOR ANY INCIDENTAL OR CONSEQUENTIAL DAMAGES FOR BREACH OF ANY EXPRESS OR IMPLIED WARRANTY ON THIS PRODUCT. EXCEPT TO THE EXTENT PROHIBITED BY LAW, THIS WARRANTY IS EXCLUSIVE AND IN LIEU OF ALL OTHER EXPRESS AND IMPLIED WARRANTIES WHATSOEVER, INCLUDING BUT NOT LIMITED TO, THE WARRANTY OF MERCHANTABILITY AND FITNESS FOR A PRACTICAL PURPOSE.

This warranty gives you specific legal rights. You may have other rights which vary from state to state.

Specifications may change without notice.

PURE RESONANCE AUDIO®
(866) 676-7804
sales@pureresonanceaudio.com
www.PureResonanceAudio.com