



# PSB-1

JBL® Professional SoundBar



## Owner's Manual

## Important Safety Instructions

1. Read these instructions – All the safety and operating instructions should be read before this product is operated.
2. Keep these instructions – The safety and operating instructions should be retained for future reference.
3. Heed all warnings – All warnings on the appliance and in the operating instructions should be adhered to.
4. Follow all instructions – All operating and use instructions should be followed.
5. Do not use this apparatus near water – The appliance should not be used near water or moisture – for example, in a wet basement or near a swimming pool, and the like.
6. Clean only with dry cloth.
7. Do not block any ventilation openings. Install in accordance with the manufacturer's instructions.
8. Do not install near any heat sources such as radiators, heat registers, stoves, or other apparatus (including amplifiers) that produce heat.
9. Do not defeat the safety purpose of the polarized or grounding plug. A polarized plug has two blades with one wider than the other. A grounding plug has two blades and a third grounding prong. The wide blade or the third prong is provided for your safety. If the provided plug does not fit into your outlet, consult an electrician for replacement of the obsolete outlet.
10. Protect the power cord from being walked on or pinched particularly at the plugs, convenience receptacles, and at the point where they exit from the apparatus.
11. Only use attachments/accessories specified by the manufacturer.
12. Unplug this apparatus during lightning storms or when unused for long periods of time.
13. Refer all servicing to qualified service personnel. Servicing is required when the apparatus has been damaged in any way, such as power-supply cord or plug is damaged, liquid has been spilled or objects have fallen into the apparatus, the apparatus has been exposed to rain or moisture, does not operate normally, or has been dropped.
14. Do not install this equipment in a confined or building-in space such as a book case or similar unit, and remain a well ventilation conditions at open site. The ventilation should not be impeded by covering the ventilation openings with items such as newspaper, table-cloths, curtains etc.
15. No naked flame sources, such as lighted candles, should be placed on the apparatus.
16. Attention should be drawn to the environmental aspects of battery disposal.
17. The use of apparatus in moderate climates.
18. **WARNING: To reduce the risk of fire or electric shock, do not expose this apparatus to rain or moisture.**
19. Batteries (battery pack or batteries installed) shall not be exposed to excessive heat such as sunshine, fire or the like.

20.

### **WARNING**

Do not ingest the battery, Chemical Burn Hazard

(The remote control supplied with) This product contains a coin/button cell battery. If the coin/button cell battery is swallowed, it can cause severe internal burns in just 2 hours and can lead to death.



Keep new and used batteries away from children.

If the battery compartment does not close securely, stop using the product and keep it away from children.

If you think batteries might have been swallowed or placed inside any part of the body, seek immediate medical attention.

21. The MAINS plug/appliance coupler is used as the disconnect device, the disconnect device shall remain readily operable.

22. **CAUTION: These servicing instructions are for use by qualified service personnel only. To reduce the risk of electric shock, do not perform any servicing other than that contained in the operating instructions unless you are qualified to do so.**





- This lightning flash with arrowhead symbol within an equilateral triangle is intended to alert the user to the presence of non-insulated “dangerous voltage” within the product’s enclosure that may be of sufficient magnitude to constitute a risk of electric shock.

- **Warning: To reduce the risk of electric shock, do not remove cover (or back) as there are no user-serviceable parts inside. Refer servicing to qualified personnel.**

- The exclamation point within an equilateral triangle is intended to alert the user to the presence of important operating and maintenance instructions in the literature accompanying the appliance.

23.

	<p><b>WEEE Directive</b></p> <p>Correct Disposal of this product. This marking indicates that this product should not be disposed with other household wastes throughout the EU. To prevent possible harm to the environment or human health from uncontrolled waste disposal, recycle it responsibly to promote the sustainable reuse of material resources. To return your used device, please use the return and collection systems or contact the retailer where the product was purchased. They can take this product for environmental safe recycling.</p>
--	--

# Contents

- Introduction ..... 1
- Included Items ..... 1
- Volume Control Schemes ..... 2
  - Integration with a Variable Output TV ..... 2
  - Integration with A Fixed Output TV ..... 3
- Basic Connectors and Indicators ..... 4
  - Analog Input ..... 4
  - Power ..... 4
  - Power Status LED ..... 4
- Installer Settings ..... 5
  - Source Volume Switch ..... 5
  - Volume Switch ..... 6
- Top Panel / Remote Control ..... 7
  - Volume Up ..... 7
  - Volume Down ..... 7
  - Mute ..... 7
- Front-Panel ..... 8
  - Volume Indication ..... 8
  - IR Receiver ..... 8
- Programming the Soundbar to Respond to Any Remote ..... 9
- Programming a Universal Remote to Control the Soundbar ..... 11
- Mounting the Soundbar ..... 12
  - Table-Mounting the Soundbar ..... 12
  - Wall-Mounting the Soundbar ..... 13
- Dimensions ..... 14
- Specifications ..... 15
- Troubleshooting ..... 16
- JBL Service Contact Information ..... 17
- Warranty Information ..... 18

## Introduction

Thank you for choosing this JBL Professional product.

The JBL® Professional SoundBar PSB-1 is designed specifically for hotels and cruise ships in need of a simple, reliable, and low-cost audio upgrade for guestroom televisions. With an application-specific feature set built on a foundation of legendary JBL sound, the JBL® Professional SoundBar PSB-1 is designed to please not only hospitality guests, but also technical AV staff and hospitality business owners.

This manual contains all the information you need to set up, connect, and adjust your new speaker system. For additional information, please visit [www.jblpro.com](http://www.jblpro.com).

## Included Items

- |                                      |   |
|--------------------------------------|---|
| <b>A.</b> Soundbar                   | <b>G.</b> Rear security plate                 |
| <b>B.</b> Power cable                | <b>H.</b> Rear security plate screw           |
| <b>C.</b> RCA cable (3 feet)         | <b>I.</b> Top security plate                  |
| <b>D.</b> RCA-to-3.5mm cable adapter | <b>J.</b> Top security plate screws           |
| <b>E.</b> Mounting brackets          | <b>K.</b> Product manual                      |
| <b>F.</b> Mounting screws            | <b>L.</b> Remote control (batteries included) |

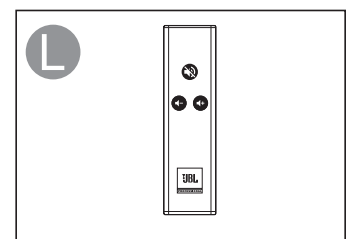
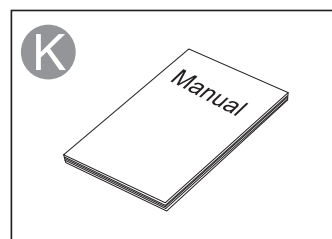
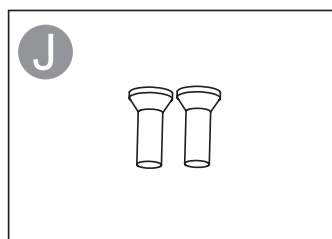
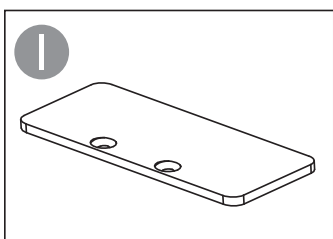
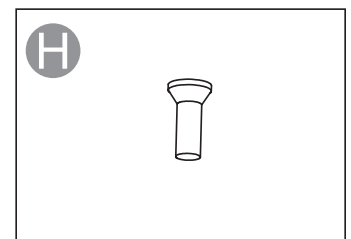
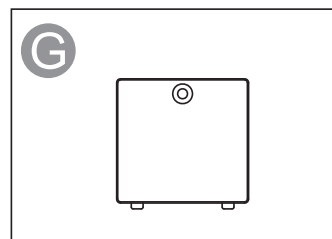
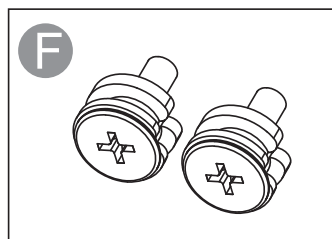
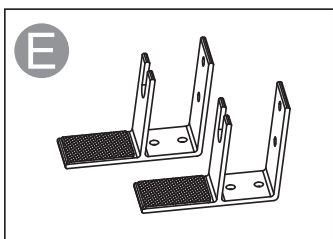
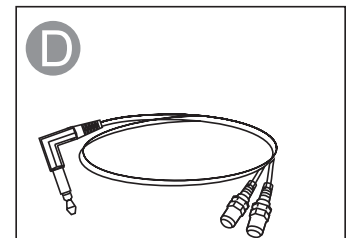
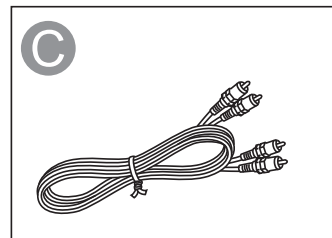
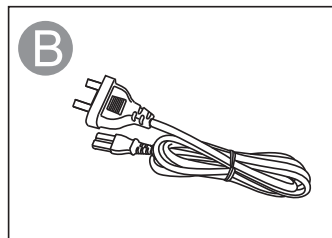
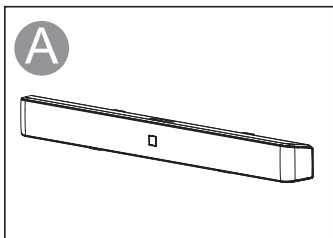

## Volume Control Schemes

The JBL® Professional SoundBar PSB-1 is designed to connect to the line-level, stereo, analog output of a TV. Many TVs offer an analog output, only a subset of TV's allow their analog output to send a signal whose volume level tracks with the volume adjustments being made to the TV. This feature is commonly known as "variable output."

Other TV's do not offer variable output, which means their analog output sends a signal whose volume remains fixed at (or near) 100% loudness, regardless of the volume adjustments made upstream to the TV. Fortunately, the JBL® Professional SoundBar PSB-1 is designed to accommodate either type of TV, with a single remote controlling the entire system in either scenario.

### INTEGRATION WITH A VARIABLE OUTPUT TV

If your TV supports variable audio output, we recommend using the soundbar as follows:

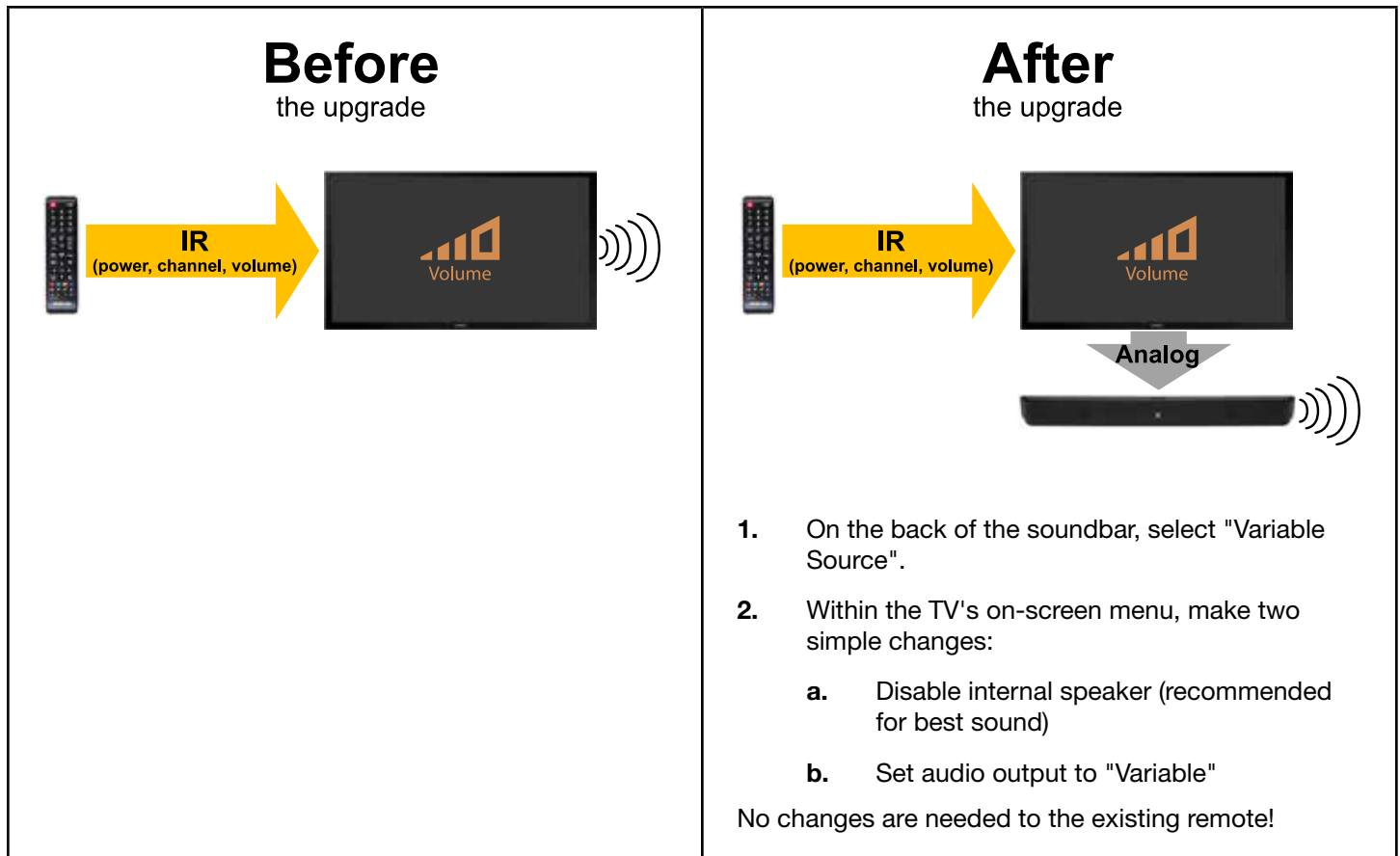

As the diagram above implies, the end-user makes volume adjustments directly to the TV (which indicates volume via the TV's standard on-screen volume graphic), while the soundbar volume remains fixed. This system is extremely simple, reliable, and easily installed.

## INTEGRATION WITH A FIXED OUTPUT TV

If your TV does not support variable audio output, we recommend using the soundbar as follows:

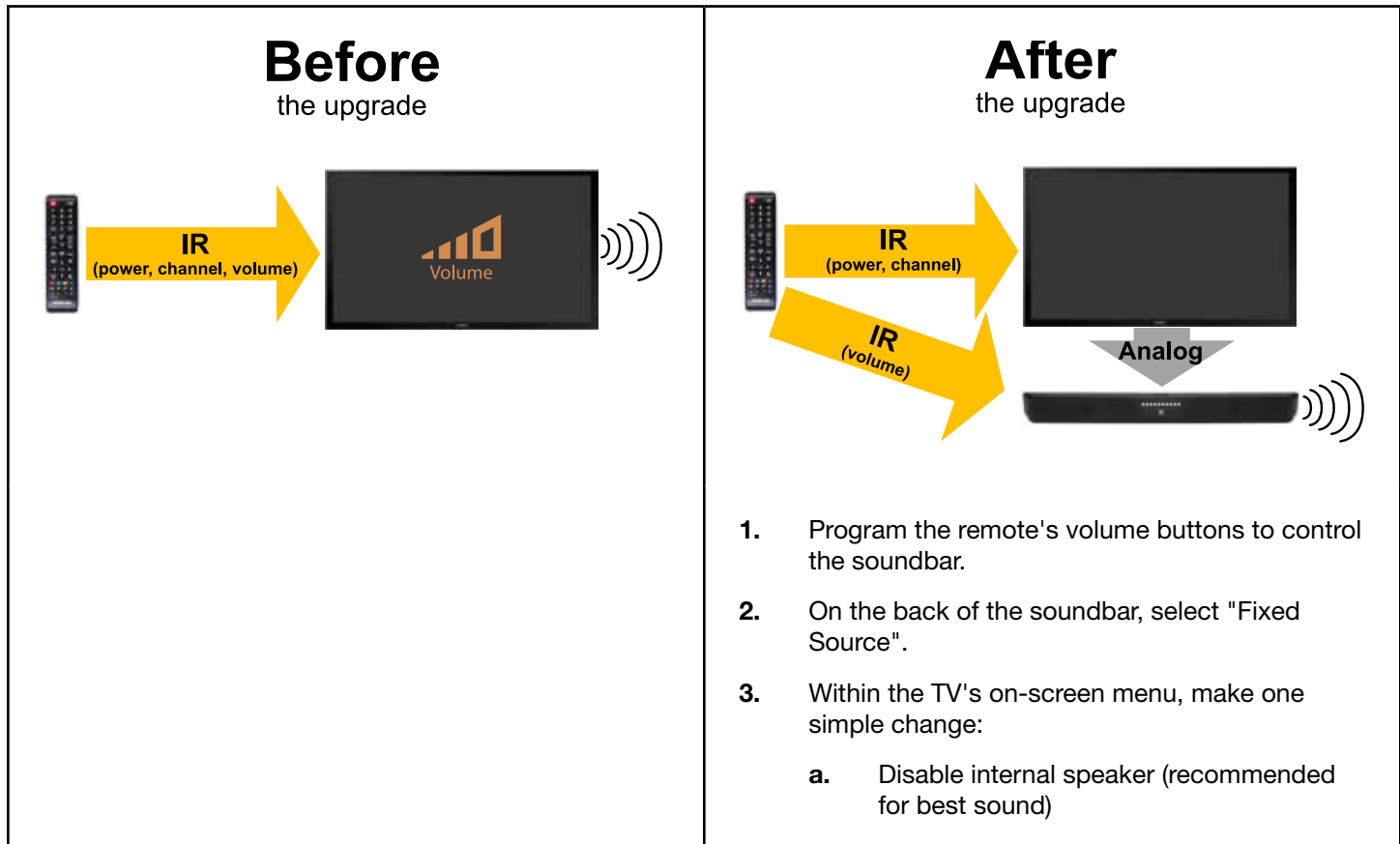

As the diagram above implies, the end-user makes volume adjustments directly to the soundbar (which indicates volume via 10 front panel LEDs). Compared to the previous system, this requires a slightly longer setup time, because a remote (or the soundbar itself—see "*Programming the Soundbar to Respond to Any Remote*" on page 9) requires IR code programming. That being said, this system is still simple, reliable, and easily installed.

## Basic Connectors and Indicators

### ANALOG INPUT

Connect this jack to the line-level, stereo, analog output jack of your TV using the included RCA cable.

If your TV has a 3.5mm analog output jack, then use the included RCA-to-3.5mm adapter.

Longer cables can be used if needed, however we do not recommend using unbalanced cables longer than 10 feet due to the likelihood of added noise.

If your TV has physically separate “fixed” and “variable” audio output jacks, make sure to connect to the appropriate jack based on the desired volume control scheme (see "*Volume Control Schemes*" on page 2).

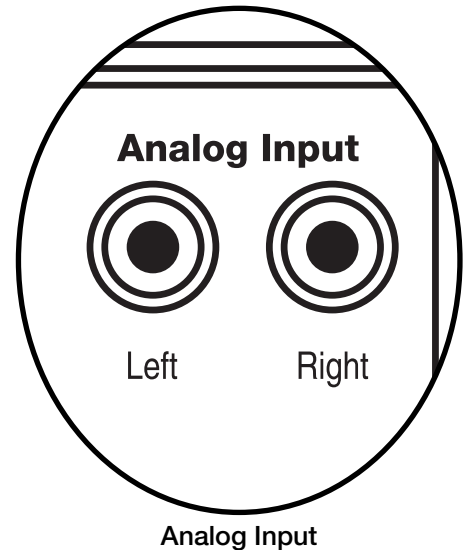

### POWER

Connect the power cable (included) to this connector.

The JBL® Professional SoundBar PSB-1 has an “Auto-Standby” feature. After 60 minutes of audio inactivity, the soundbar will automatically enter standby mode, which reduces energy consumption. Once audio is detected at the input, the PSB-1 will automatically return to its normal mode of operation.

Additionally, if the soundbar has been set to "Fixed Source" mode (see "*Installer Settings*" on page 5) and the volume is greater than 30%, then the volume will also reset to 30% (and unmuted) after 60 minutes of audio inactivity. This ensures that, for example, hotel guests checking into the room aren't startled by a loud volume level set by the previous guest.

### POWER STATUS LED

On the soundbar's front panel there are 10 green volume indicator LEDs, the first of which doubles as a power status indicator. Unlike the other 9 LEDs, this LED can turn amber, and it allows the installer to confirm proper power connection and operation.

LED	
Green	Normal mode
Amber	Standby mode
[off]	PSB-1 is unplugged from power or has a fault



## Installer Settings

This section contains advanced settings intended only for the installer. Once the appropriate settings are chosen, the Rear Security Plate (included) can be installed with a screw (included) to prevent end-users from tampering with these critical settings.

### SOURCE VOLUME SWITCH

This 2-position switch allows the installer to select the desired volume control scheme (see "*Volume Control Schemes*" on page 2). When designing a TV-plus-soundbar system, one must decide where to control volume: at the source (i.e. the TV) or at the soundbar. While each scheme has its own merits, the JBL® Professional SoundBar PSB-1 is designed to accommodate either scenario for maximum flexibility.

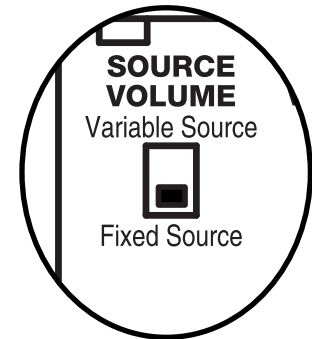

Source Volume Switch

#### *"Variable Source" (fixed soundbar)*

Select this position if volume is being controlled at the TV. In this mode of operation, the TV sends volume-adjusted audio levels to the soundbar, which itself maintains a fixed volume level. In this mode, the end user can adjust volume via the following user interfaces:

- The existing remote control that came with the TV
- A third party universal remote control configured to control the TV's volume
- The buttons built into the TV

#### *"Fixed Source" (variable soundbar)*

Select this position if volume is being controlled at the soundbar. In this mode of operation, the TV sends fixed audio levels to the soundbar, where volume is then adjusted. In this mode, the end user can adjust volume via the following user interfaces:

- The existing remote control that came with the TV (see "*Programming the Soundbar to Respond to Any Remote*" on page 9)
- A third party universal remote control configured to control the PSB-1's volume (see "*Programming a Universal Remote to Control the Soundbar*" on page 11)
- The soundbar's remote control (included)
- The buttons built into the soundbar

## VOLUME SWITCH

This 4-position switch allows the installer to place an upper limit on the loudness of the soundbar. This is helpful, for example, to reduce sound transfer between adjacent rooms in a hotel with thin walls.

“Max” = loudest

“Low” = quietest

Position	Max Volume Allowed
Max	100%
High	90%
Med	80%
Low	60%

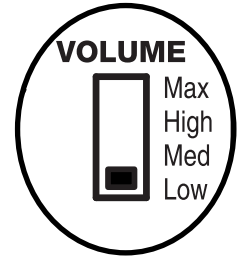

Volume Switch

**NOTE:** This feature is separate from the internal dynamic compressor/limiter DSP algorithm, which automatically optimizes fidelity and transducer protection (and which cannot be bypassed or adjusted).

A four-position switch (instead of, for example, a fine-tunable dial) allows easily repeatable settings when deploying soundbars across multiple similar rooms/spaces.

To safely determine the maximum acceptable volume and also to optimize the system by reducing the noise floor, we recommend taking the following steps:

If the soundbar is set to "Variable Source" mode:

1. Ensure TV audio can be heard coming from the soundbar
2. Set the soundbar's "Volume" switch to "Low"
3. Increase the TV's volume to its maximum allowed setting
4. If more output is needed, set the soundbar's "Volume" switch to "Medium"
5. If more output is needed, set the soundbar's "Volume" switch to "High"
6. If more output is needed, set the soundbar's "Volume" switch to "Max"

If the soundbar is set to "Fixed Source" mode:

1. Ensure TV audio can be heard coming from the soundbar
2. Set the soundbar's "Volume" switch to "Low"
3. Hold the soundbar's "Volume Up" button until the soundbar is turned all the way up (to 60%)
4. If more output is needed, set the "Volume" switch to "Medium" and turn the soundbar all the way up (to 80%)
5. If more output is needed, set the "Volume" switch to "High" and turn the soundbar all the way up (to 90%)
6. If more output is needed, set the "Volume" switch to "Max" and turn the soundbar all the way up (to 100%)

## Top Panel / Remote Control

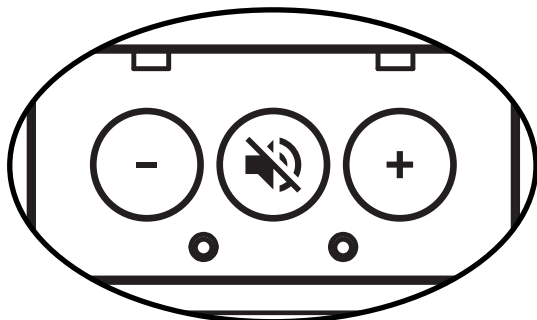

PSB-1 Top Panel

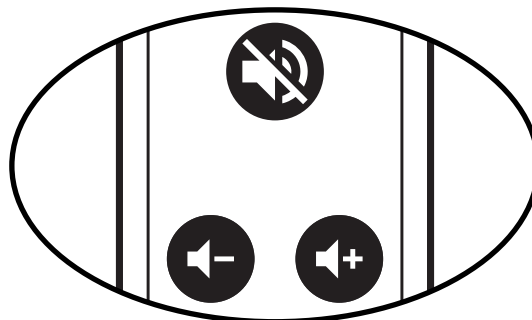

Remote Control

When the soundbar is set to “Fixed Source” (variable soundbar) mode, these buttons allow the end user to control the internal volume of the soundbar—either from the top panel or from a remote.

**NOTE 1:** While similar in certain ways, these volume buttons differ significantly from the “Volume” switch on the rear of the device. These buttons are for the end user (giving them granular volume control during TV watching), whereas the rear “Volume” switch is for the installer (giving him/her the ability to choose an overall volume limit during installation).

**NOTE 2:** When the soundbar is set to “Variable Source” (fixed soundbar) mode, these buttons are irrelevant and therefore have no effect on the operation of the soundbar. Therefore, when “Variable Source” (fixed soundbar) is selected, we recommend installing the Top Security Plate (included) because it will streamline the soundbar's appearance, and it will eliminate the scenario in which the end-user presses the volume buttons atop the soundbar and then becomes confused and frustrated by the volume remaining unaffected.

### VOLUME UP

This button increases the volume of the soundbar.

### VOLUME DOWN

This button decreases the volume of the soundbar.

### MUTE

This button mutes the soundbar. Press and release to mute. Once muted, press and release this button again (or Volume Up) to unmute.

## Front-Panel



### **VOLUME INDICATION**

When the soundbar is set to “Fixed Source” (variable soundbar) mode, these 10 LEDs indicate the volume setting on the soundbar.

When the soundbar is set to “Variable Source” (fixed soundbar) mode, these 10 LEDs are irrelevant and therefore will not illuminate.

### **IR RECEIVER**

When the soundbar is set to “Fixed Source” (variable soundbar) mode, IR commands (coming from a remote control) can enter this IR receiver and cause the soundbar to alter its internal volume accordingly.

When the soundbar is set to “Variable Source” (fixed soundbar) mode, this IR receiver is irrelevant and therefore has no effect on the volume of the soundbar—even in the presence of otherwise valid IR commands.

## Programming the Soundbar to Respond to Any Remote

When dealing with a “fixed output only” TV, the remote must communicate directly with the soundbar (see “*Volume Control Schemes*” on page 2).

Using the “IR Learning” feature, you can program the soundbar to respond to any remote’s volume-related IR commands (volume Up/Down/Mute). This allows the end user to control the entire system with a single remote—whether it’s a non-programmable remote that came with the TV or a fully programmable third-party remote.

This feature is particularly useful when dealing with non-programmable remotes (e.g. the remote that came with the TV) which otherwise would not be able to control the soundbar.

**NOTE:** Some steps will time out, so we recommend reading through this entire procedure before you begin.

Required steps:

1. Ensure that the soundbar is powered on and in “Fixed Source” mode.
2. Aim the remote at the IR receiver on the front panel of the soundbar from 12-36 inches (300 – 900 mm) away.
3. On the soundbar, press and hold all 3 buttons (Up/Down/Mute) on the top panel for 7 or more seconds. After 7 seconds, the front-panel volume indicator will flash a pattern to indicate that the soundbar is now in IR Learning mode.
  - a. To program Volume Up:
    - i. Press and release Volume Up on the soundbar
    - ii. Press and release Volume Up on the remote
  - c. To program Volume Down:
    - i. Press and release Volume Down on the soundbar
    - ii. Press and release Volume Down on the remote
  - c. To program Mute:
    - i. Press and release Mute on the soundbar
    - ii. Press and release Mute on the remote
4. To exit IR Learning mode, do one of the following:
  - a. On the soundbar, press and hold Volume Down and Volume Up buttons (NOT mute) on the top panel for 7 or more seconds. After 7 seconds, the front-panel volume indicator will flash.
  - b. Do not press any buttons on the soundbar for 30 seconds.

The remote control should now have volume control over the JBL® Professional SoundBar PSB-1.

5. **OPTIONAL BUT RECOMMENDED:** In order to prevent end-user confusion from seeing two independent volume indicators during volume adjustment (one indicator on the TV screen, plus another indicator on the soundbar's front panel), we recommend doing one of the following:
  - a. If using a non-programmable remote that came with the TV, disable the TV’s on-screen volume indication (please consult your TV manual).
  - b. If using a programmable remote, ensure the remote is issuing IR volume commands NOT recognized by the TV.

To reset the IR Learning settings back to factory default, use the following sequence:

1. Press and release Volume Up + Volume Down.
2. Press and release Mute.
3. Repeat the above two steps 4 more (i.e. 5 total) times.

In other words, follow these ten steps:

1. Press and release Volume Up + Volume Down.
2. Press and release Mute.
3. Press and release Volume Up + Volume Down.
4. Press and release Mute.
5. Press and release Volume Up + Volume Down.
6. Press and release Mute.
7. Press and release Volume Up + Volume Down.
8. Press and release Mute.
9. Press and release Volume Up + Volume Down.
10. Press and release Mute.

The soundbar will then flash a pattern to indicate that the IR learning feature has been reset.

## Programming a Universal Remote to Control the Soundbar

When dealing with a “fixed output only” TV, it’s necessary for a remote to communicate directly with the soundbar (see “*Volume Control Schemes*” on page 2).

If you have a programmable (AKA “universal”) remote, it can control the JBL® Professional SoundBar PSB-1 by issuing the following IR codes:

Command	Code
Mute	8070H C1
Volume Up	8070H C7
Volume Down	8070H C8

If the above commands are not working for any reason, remember you also have the option of using the “IR Learning” feature to issue virtually any IR Code to the soundbar in order to control its volume functions (see “*Programming the Soundbar to Respond to Any Remote*” on page 9).

# Mounting the Soundbar

## TABLE-MOUNTING THE SOUNDBAR

Remove the Rubber Plugs.

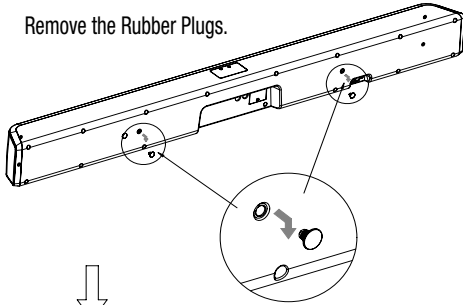

Tighten the 2 X M5 Mounting Screws (included) on the soundbar.

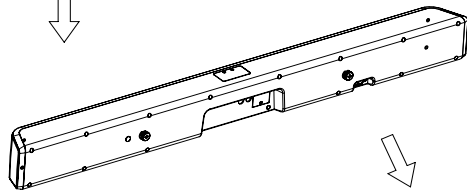
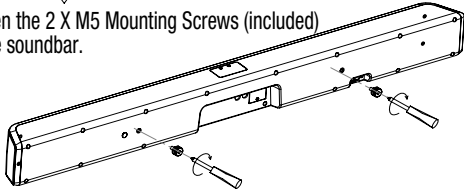

Tighten the bracket on the table using 4 X M4 screws (the distance between two brackets should be 406mm (16 inches)).

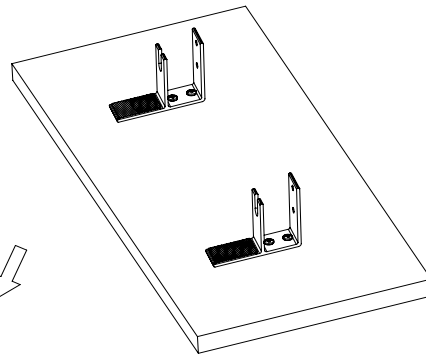
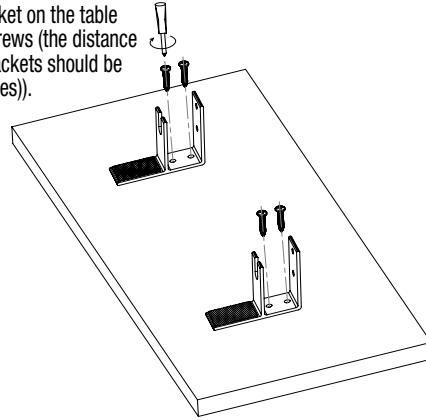

There is a gap in the rubber surrounding the screws. Ensure this gap is facing upwards, and then slide the secured Mounting Screws onto the Mounting Brackets.

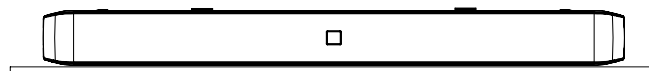
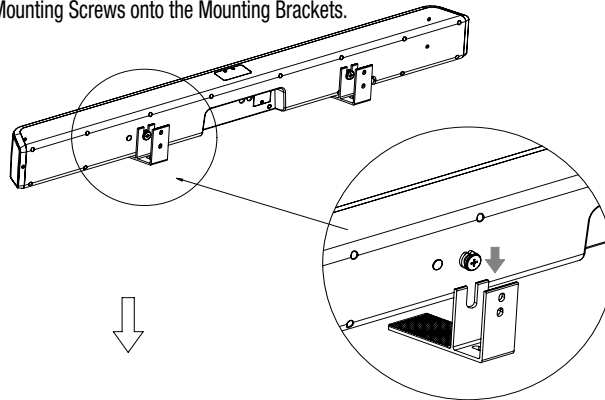



## WALL-MOUNTING THE SOUNDBAR

Remove the Rubber Plugs.

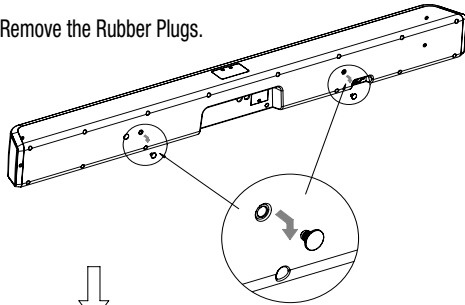

Tighten the 2 X M5 Mounting Screws (included) on the soundbar.

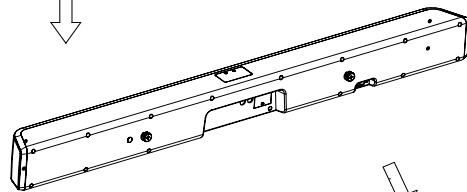
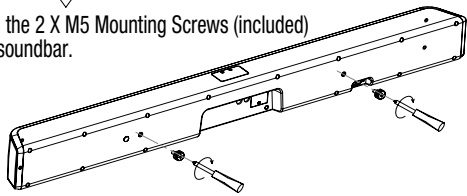

Tighten the bracket on the wall using 4 X M4 screws (the distance between two brackets should be 406mm (16 inches)).

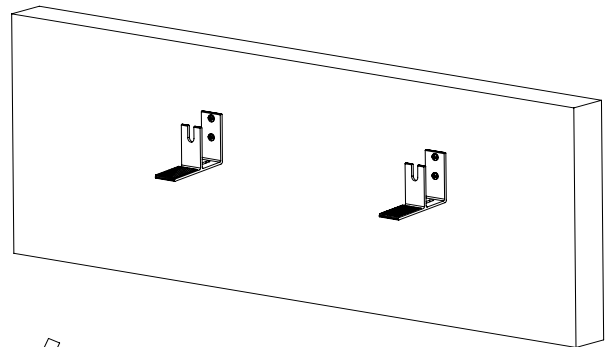
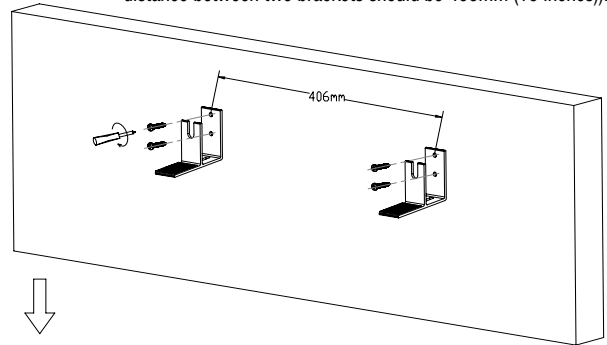

There is a gap in the rubber surrounding the screws. Ensure this gap is facing upwards, and then slide the secured Mounting Screws onto the Mounting Brackets.

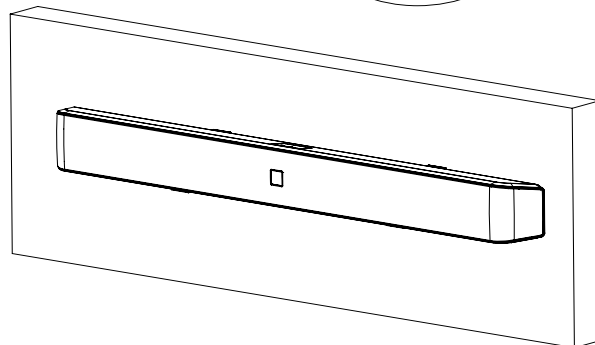
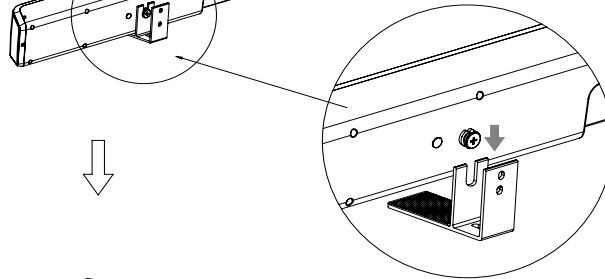
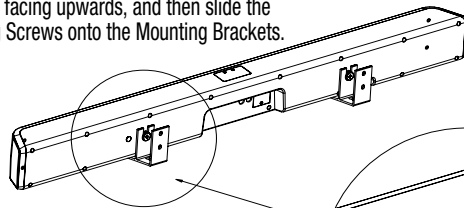

**NOTE:** For further security, an optional security strap can be attached to the soundbar.

## Dimensions

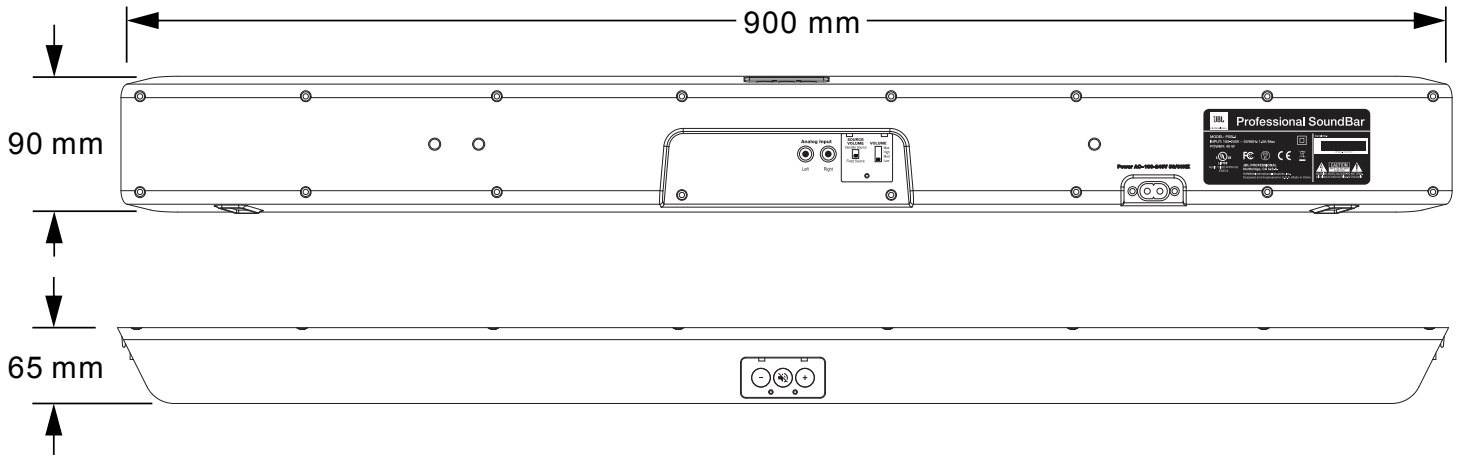

## Specifications

<b>Frequency Response (<math>\pm 3</math> dB):</b>	56 Hz – 20 kHz
<b>Frequency Response (-10 dB):</b>	42 Hz – 20 kHz
<b>Crossover:</b>	4300 Hz, 1st order LF, 1st order HF
<b>Maximum Peak SPL (0 dBV):</b>	90 dB*
<b>Maximum Peak SPL (0 dBV):</b>	94 dB* (Both Channels Driven)
<b>Input Connectors:</b>	RCA
<b>Input Sensitivity (-10 dBV):</b>	85 dB / 1 m
<b>HF Driver Size:</b>	19 mm (0.75 in) Soft Dome Tweeter
<b>LF Driver Size:</b>	51 mm (2.0 in) Low Frequency Loudspeaker
<b>Power Amp:</b>	20 W Per Channel, Class D
<b>Enclosure Material:</b>	Injection-Molded ABS
<b>Enclosure Finish:</b>	Black
<b>Dimensions (H x W x D):</b>	90 x 900 x 65 mm (3.54 x 35.4 x 2.55 in)
<b>Weight:</b>	1.8 kg (4.0 lbs)
<b>Shipping Weight:</b>	2.5 kg (5.5 lbs)

\*Full bandwidth pink noise measured C-Weighted

## Troubleshooting

### PROBLEM

"The soundbar is not producing sound."

### SOLUTION

Ensure the soundbar is connected to a properly functioning power outlet. When connected to power, a front panel LED will turn either amber or green. If the LED does not illuminate, there is a fault with the power outlet, the power cord, or the soundbar unit itself. If the front panel LED illuminates amber, this means the device is in standby mode. To bring the device out of standby mode, connect an audio source with active (and sufficiently loud) audio. Once the audio is detected, the LED will change from amber to green, and the soundbar will begin producing sound.

### PROBLEM

"The soundbar is too quiet."

### SOLUTION

First, ensure the "Volume" switch is set correctly (see "*Volume Switch*" on page 6). Next, ensure the soundbar is in the correct mode (see "*Volume Control Schemes*" on page 2 and "*Source Volume Switch*" on page 5).

### PROBLEM

"I've put the soundbar into "Variable mode", but the volume buttons aren't working. The front panel flashes every time I press the volume buttons."

### SOLUTION

There is no such thing as "variable mode". You've placed the soundbar into variable \*SOURCE\* mode. The two "Volume Source" positions ("Variable Source" and "Fixed Source") are labeled based on the TV's (i.e. the source's) behavior, not the soundbar's behavior. So if you want the soundbar itself to have a variable volume, choose "Fixed Source" instead.

## JBL Service Contact Information

### MAILING ADDRESS:

JBL Professional  
8500 Balboa Blvd.  
Northridge, CA 91329

### SHIPPING ADDRESS:

Please contact JBL Professional Customer Service for shipping information prior to repairs.

### CUSTOMER SERVICE:

Monday through Friday  
8:00am – 5:00pm  
Pacific Coast Time in the U.S.A.  
(800) 8JBLPRO (800.852.5776)  
[www.jblproservice.com](http://www.jblproservice.com)

### PRODUCT REGISTRATION:

Register your product online at [www.jblpro.com/registration](http://www.jblpro.com/registration)

### ON THE WORLD WIDE WEB:

[www.jblpro.com](http://www.jblpro.com)

### PROFESSIONAL CONTACTS, OUTSIDE THE USA:

Contact the JBL Professional Distributor in your area. A complete list of JBL Professional international distributors is provided at our U.S.A. website: [www.jblpro.com](http://www.jblpro.com)

### EN DEHORS DES ETATS-UNIS:

Contactez votre Distributeur JBL Professional. Une liste complète de nos distributeurs internationaux est disponible sur le site web—[www.jblpro.com](http://www.jblpro.com)

### INTERNATIONAL:

Wenden Sie sich an Ihre örtliche JBL Professional Vertretung. Eine vollständige Liste der internationalen JBL-Vertretungen finden Sie auf unserer Website unter [www.jblpro.com](http://www.jblpro.com)

### FUERA DE LOS ESTADOS UNIDOS:

Comuníquese con el distribuidor de JBL Professional de su zona. En nuestro sitio web, [www.jblpro.com](http://www.jblpro.com), encontrará una lista completa de los distribuidores de JBL International.



## Warranty Information

The JBL Limited Warranty on professional loudspeaker products (except for enclosures) remains in effect for five years from the date of the first consumer purchase. JBL amplifiers are warranted for three years from the date of original purchase. Enclosures and all other JBL products are warranted for two years from the date of original purchase.

### WHO IS PROTECTED BY THIS WARRANTY?

Your JBL Warranty protects the original owner and all subsequent owners so long as: A.) Your JBL product has been purchased in the Continental United States, Hawaii or Alaska. (This Warranty does not apply to JBL products purchased elsewhere except for purchases by military outlets. Other purchasers should contact the local JBL distributor for warranty information.); and B.) The original dated bill of sale is presented whenever warranty service is required.

### WHAT DOES THE JBL WARRANTY COVER?

Except as specified below, your JBL Warranty covers all defects in material and workmanship. The following are not covered: Damage caused by accident, misuse, abuse, product modification or neglect; damage occurring during shipment; damage resulting from failure to follow instructions contained in your Instruction Manual; damage resulting from the performance of repairs by someone not authorized by JBL; claims based upon any misrepresentations by the seller; any JBL product on which the serial number has been defaced, modified or removed.

### WHO PAYS FOR WHAT?

JBL will pay all labor and material expenses for all repairs covered by this warranty. Please be sure to save the original shipping cartons because a charge will be made if replacement cartons are requested. Payment of shipping charges is discussed in the next section of this warranty.

### HOW TO OBTAIN WARRANTY PERFORMANCE

If your JBL product ever needs service, write or telephone us at JBL Incorporated (Attn: Customer Service Department), 8500 Balboa Boulevard, PO. Box 2200, Northridge, California 91329 (818/893-8411). We may direct you to an authorized JBL Service Agency or ask you to send your unit to the factory for repair. Either way, you'll need to present the original bill of sale to establish the date of purchase. Please do not ship your JBL product to the factory without prior authorization. If transportation of your JBL product presents any unusual difficulties, please advise us and we may make special arrangements with you. Otherwise, you are responsible for transporting your product for repair or arranging for its transportation and for payment of any initial shipping charges. However, we will pay the return shipping charges if repairs are covered by the warranty.

### LIMITATION OF IMPLIED WARRANTIES

ALL IMPLIED WARRANTIES, INCLUDING WARRANTIES OF MERCHANTABILITY AND FITNESS FOR PARTICULAR PURPOSE, ARE LIMITED IN DURATION TO THE LENGTH OF THIS WARRANTY.

### EXCLUSION OF CERTAIN DAMAGES

JBL'S LIABILITY IS LIMITED TO THE REPAIR OR REPLACEMENT, AT OUR OPTION, OF ANY DEFECTIVE PRODUCT AND SHALL NOT INCLUDE INCIDENTAL OR CONSEQUENTIAL DAMAGES OF ANY KIND. SOME STATES DO NOT ALLOW LIMITATIONS ON HOW LONG AN IMPLIED WARRANTY LASTS AND/OR DO NOT ALLOW THE EXCLUSION OF INCIDENTAL OR CONSEQUENTIAL DAMAGES, SO THE ABOVE LIMITATIONS AND EXCLUSIONS MAY NOT APPLY TO YOU. THIS WARRANTY GIVES YOU SPECIFIC LEGAL RIGHTS, AND YOU MAY ALSO HAVE OTHER RIGHTS, WHICH VARY, FROM STATE TO STATE.

#### JBL Professional

8500 Balboa Boulevard  
Northridge, CA 91329 USA  
Visit us online at [www.jblpro.com](http://www.jblpro.com)





Part Number:  
5096837-00 Rev A