



# PV<sup>®</sup>i 6500

400-WATT, 6-CHANNEL MIXER AMPLIFIER  
WITH SD CARD / USB MP3 / BLUETOOTH<sup>®</sup> PLAYER

## Operating Manual



[www.peavey.com](http://www.peavey.com)



[www.peavey.com](http://www.peavey.com)



Intended to alert the user to the presence of uninsulated "dangerous voltage" within the product's enclosure that may be of sufficient magnitude to constitute a risk of electric shock to persons.

Intended to alert the user of the presence of important operating and maintenance (servicing) instructions in the literature accompanying the product.

**CAUTION:** Risk of electrical shock — DO NOT OPEN!



**CAUTION:** To reduce the risk of electric shock, do not remove cover. No user serviceable parts inside. Refer servicing to qualified service personnel.

**WARNING:** To prevent electrical shock or fire hazard, this apparatus should not be exposed to rain or moisture, and objects filled with liquids, such as vases, should not be placed on this apparatus. Before using this apparatus, read the operating guide for further warnings.



**Protective earthing terminal.** The apparatus should be connected to a mains socket outlet with a protective earthing connection.



Este símbolo tiene el propósito, de alertar al usuario de la presencia de "(voltaje) peligroso" sin aislamiento dentro de la caja del producto y que puede tener una magnitud suficiente como para constituir riesgo de descarga eléctrica.

Este símbolo tiene el propósito de alertar al usuario de la presencia de instrucciones importantes sobre la operación y mantenimiento en la información que viene con el producto.

**PRECAUCION:** Riesgo de descarga eléctrica ¡NO ABRIR!



**PRECAUCION:** Para disminuir el riesgo de descarga eléctrica, no abra la cubierta. No hay piezas útiles dentro. Deje todo mantenimiento en manos del personal técnico cualificado.

**ADVERTENCIA:** Para prevenir choque eléctrico o riesgo de incendios, este aparato no se debe exponer a la lluvia o a la humedad. Los objetos llenos de líquidos, como los floreros, no se deben colocar encima de este aparato. Antes de usar este aparato, lea la guía de funcionamiento para otras advertencias.



**Terminal de puesta a tierra de protección.** El aparato debe estar conectado a una toma de corriente con conexión a tierra de protección.



Ce symbole est utilisé dans ce manuel pour indiquer à l'utilisateur la présence d'une tension dangereuse pouvant être d'amplitude suffisante pour constituer un risque de choc électrique.

Ce symbole est utilisé dans ce manuel pour indiquer à l'utilisateur qu'il ou qu'elle trouvera d'importantes instructions concernant l'utilisation et l'entretien de l'appareil dans le paragraphe signalé.

**ATTENTION:** Risques de choc électrique — NE PAS OUVRIR!



**ATTENTION:** Afin de réduire le risque de choc électrique, ne pas enlever le couvercle. Il ne se trouve à l'intérieur aucune pièce pouvant être réparée par l'utilisateur. Confiez l'entretien et la réparation de l'appareil à un réparateur Peavey agréé.

**AVIS:** Dans le but de réduire les risques d'incendie ou de décharge électrique, cet appareil ne doit pas être exposé à la pluie ou à l'humidité et aucun objet rempli de liquide, tel qu'un vase, ne doit être posé sur celui-ci. Avant d'utiliser de cet appareil, lisez attentivement le guide fonctionnant pour avertissements supplémentaires.



**Borne de terre de protection.** L'appareil doit être connecté à une prise secteur avec une connexion à la terre.



Dieses Symbol soll den Anwender vor unisolierten gefährlichen Spannungen innerhalb des Gehäuses warnen, die von Ausreichender Stärke sind, um einen elektrischen Schlag verursachen zu können.

Dieses Symbol soll den Benutzer auf wichtige Instruktionen in der Bedienungsanleitung aufmerksam machen, die Handhabung und Wartung des Produkts betreffen.

**VORSICHT:** Risiko — Elektrischer Schlag! Nicht öffnen!



**VORSICHT:** Um das Risiko eines elektrischen Schlages zu vermeiden, nicht die Abdeckung entfernen. Es befinden sich keine Teile darin, die vom Anwender repariert werden könnten. Reparaturen nur von qualifiziertem Fachpersonal durchführen lassen.

**WARNUNG:** Um elektrischen Schlag oder Brandgefahr zu verhindern, sollte dieser Apparat nicht Regen oder Feuchtigkeit ausgesetzt werden und Gegenstände mit Flüssigkeiten gefüllt, wie Vasen, nicht auf diesen Apparat gesetzt werden. Bevor dieser Apparat verwendet wird, lesen Sie bitte den Funktionsführer für weitere Warnungen.



**Schutzerdung Terminal.** Das Gerät nur an Steckdose mit Schutzleiter angeschlossen werden.



Tarkoitettu kiinnittämään käyttäjän huomio sellaiseen eristämättömään vaaralliseen jännitteeseen tuotteen kotelossa, joka saattaa olla riittävän suuri aiheuttaakseen sähköiskuvaaran.

Tarkoitettu kiinnittämään käyttäjän huomio tärkeisiin käyttö- ja huolto-ohjeisiin tuotteen mukana seuraavassa ohjeistuksessa.

**VAROITUS:** Sähköiskun vaara — ÄLÄ AVAA!



**VAROITUS:** Sähköiskuvaaran vuoksi älä poista kantta. Ei sisällä käyttäjän huollettavissa olevia osia. Huoltaminen tulee jättää pätevän huoltohenkilöstön tehtäväksi.

**VAARA:** Sähköiskun tai tulipalon vaaran estämiseksi tätä laitetta ei saa altistaa sateelle tai kosteudelle, eikä sen päälle saa asettaa nesteellä täytettyjä esineitä, kuten maljakoita. Ennen laitteen käyttöä lue muut varoitukset käyttöohjeesta.



**Suojamaadoitus terminaali.** Laite tulee kytkeä sähköverkkoon suojajohtimella.



Är avsedd att varna användaren för förekomsten av oisolerad "farlig spänning" inom produktens hölje som kan vara av tillräcklig nivå för att personer ska riskera elektrisk stöt.

Är avsedd att uppmärksamma användaren på förekomsten av viktiga handhavande- och underhållsinstruktioner (service) i den litteratur som medföljer produkten.

**OBSERVERA:** Risk för elektrisk stöt – ÖPPNA INTE!



**OBSERVERA:** För att minska risken för elektrisk stöt, avlägsna inte höljet. Inga delar inuti kan underhållas av användaren. Låt kvalificerad servicepersonal sköta servicen.

**WARNING:** För att förebygga elektrisk stöt eller brandrisk bör apparaten inte utsättas för regn eller fukt, och föremål fylla med vätskor, såsom vasen, bör inte placeras på denna apparat. Läs bruksanvisningen för ytterligare varningar innan denna apparat används.



**Skyddsjordning terminalen.** Apparaten skall anslutas till ett uttag med skyddande jordanslutning.



Har til hensikt å advare brukeren om tilstedeværelse av uisolert "farlig spenning" inne i produktet, som kan ha tilstrekkelig styrke til å medføre risiko for elektrisk støt for en person.

Har til hensikt å informere brukeren om tilstedeværelsen av viktige bruks- og vedlikeholds (service)-instruksjoner i litteraturen som følger med produktet.



**ADVARSEL:** Risiko for elektrisk støt — MÅ IKKE ÅPNES!

**ADVARSEL:** For å redusere risikoen for elektrisk støt må ikke dekslet fjernes. Det finnes ingen deler på innsiden som brukeren kan justere. Overlat servicearbeidet til kvalifisert servicepersonell.

**ADVARSEL:** For å hindre elektrisk støt eller brannfare må ikke dette apparatet utsettes for regn eller fuktighet, og gjenstander fylt med væske, som en vase, må ikke settes på apparatet. Før du tar apparatet i bruk må du lese bruksanvisningen for ytterligere advarsler.



**Beskyttende jordingsterminal.** Apparatet må kobles til en elektrisk kontakt med et støpsel som har skjermet jordkontakt.



Bedoeld om de gebruiker te attenderen op de aanwezigheid van ongeïsoleerde "gevaarlijke spanning" binnen de behuizing van het product dat van voldoende omvang kan zijn om een risico op elektrische schokken te vormen.

Bedoeld om de gebruiker te attenderen op de aanwezigheid van belangrijke gebruiks- en onderhoudsinstructies in de literatuur bij het product.



**OPGELET:** Risico op een elektrische schok - NIET OPENEN

**OPGELET:** Om het risico op elektrische schokken te verkleinen, verwijder niet het deksel. Er zijn geen voor de gebruiker bruikbare onderdelen binnenin aanwezig. Verwijs onderhoud door naar gekwalificeerd onderhoudspersoneel.

**WAARSCHUWING:** Om elektrische schokken of brandgevaar te voorkomen, stel dit apparaat mag niet bloot aan regen of vocht ' en voorwerpen gevuld met vloeistoffen, zoals vazen mogen niet op dit apparaat worden geplaatst. Lees de gebruiksaanwijzingen voor nadere waarschuwingen voordat u dit apparaat gebruikt.



**Beschermende aardklem.** Het apparaat dient te worden aangesloten op een stopcontact met een beschermend aardcontact.



Atto ad avvisare l'utente in merito alla presenza "voltage pericoloso" non isolato all'interno della scatola del prodotto che potrebbe avere una magnitudine sufficiente a costituire un rischio di scossa elettrica per le persone.

Atto ad avvisare l'utente in merito alla presenza di istruzioni operative e di assistenza importanti (manutenzione) nel libretto che accompagna il prodotto.



**ATTENZIONE:** Rischio di scossa elettrica — NON APRIRE!

**ATTENZIONE:** per ridurre il rischio di scossa elettrica, non rimuovere il coperchio. Non vi sono parti utili all'utente all'interno. Fare riferimento a personale addetto qualificato.

**AVVERTENZA:** per prevenire il rischio di scossa o il rischio di incendio, questo apparecchio non dovrebbe essere esposto a pioggia o umidità, e oggetti riempiti con liquidi, come vasi, non dovrebbero essere posizionati sopra questo apparecchio. Prima di usare questo apparecchio, leggere la guida operativa per ulteriori informazioni.



**Morsetto di terra di protezione.** L'apparecchio deve essere collegato a una presa di corrente di rete con un conduttore di terra.



Destinado a alertar o usuário da presença de "voltagem perigosa" não isolada dentro do receptáculo do produto que pode ser de magnitude suficiente para constituir um risco de choque elétrico a pessoas.

Destinado a alertar o usuário da presença de instruções importantes de operação e manutenção (conserto) na literatura que acompanha o produto.



**CUIDADO:** Risco de choque elétrico — NÃO ABRA!

**CUIDADO:** Para evitar o risco de choque elétrico, não remova a cobertura. Contém peças não reparáveis pelo usuário. Entregue todos os consertos apenas a pessoal qualificado.

**ADVERTÊNCIA:** Para evitar choques elétricos ou perigo de incêndio, este aparelho não deve ser exposto à chuva ou umidade e objetos cheios de líquidos, tais como vasos, não devem ser colocados sobre ele. Antes de usar este aparelho, leia o guia de operação para mais advertências.



**Terminal de aterramento de proteção.** O aparelho deve ser ligado a uma tomada elétrica com ligação à terra de proteção.



人体への電気ショックの危険が考えられる製品筐体内の非絶縁「危険電圧」の存在をユーザーに警告するものです。

製品に付属している説明書に記載の重要な操作およびメンテナンス(サービス)要領の存在をユーザーに警告するものです。

注意: 電気ショックの危険あり — 開けないでください!



注意: 電気ショックの危険を低減するため、カバーを外さないでください。内部部品はユーザーによるサービス不可。資格のあるサービス要因のサービスを要請してください。

警告: 電気ショックまたは火災の危険を避けるため、この装置を雨または湿気にさらしてはなりません。また、過敏な液体を含む物をこの装置上に置いてはなりません。この装置を使用する前に、警告事項について操作ガイドをお読みください。



保護接地端子。装置は保護接地に接続している電源コンセントに接続する必要があります



三角形内带有箭头闪电状符号意在敬告用户, 表明产品内部有非绝缘的“危险电压”存在, 而且具有足以致人触电的危险。

三角形内的感叹号意在警告用户, 表明与机器的操作和维护(维修)有关的重要说明。



警告: 触电危险—勿打开!

警告: 为了避免触电危险, 请勿打开机壳。机内无用户可以维修的部件。需要维修时, 请与指定的专业维修人员联系。

警告: 为了避免触电或火灾危险, 请勿将本机置于雨中或潮湿之处。请勿将装满液体的物体, 例如花瓶等置于本机之上。使用本机之前, 请仔细阅读本操作说明书中的安全说明。



保 保护接地端子。设备应该连接到带有保护接地连接的电源插座。



제품의 케이스 내에 감전을 유발할 수 있는 절연되지 않은 " 위험한 전압 " 이 존재함을 사용자에게 알립니다. 제품과 함께 제공되는 인쇄물에 중요한 작동 및 유지 보수 (서비스) 지침이 있음을 사용자에게 알립니다.

**주의:** 감전 위험 — 열지 마십시오!



**주의:** 감전 위험을 낮추기 위해 덮개를 제거하지 마십시오. 장치 내부에는 사용자가 직접 수리할 수 있는 부품이 없습니다. 자격을 갖춘 서비스 요원에게 서비스를 의뢰하십시오.

**경고:** 감전 또는 화재 위험을 예방하기 위해 본 기기를 비 또는 습기에 노출하거나 꽃병과 같이 액체가 들어 있는 물체를 본 기기 위에 올려놓지 마십시오. 본 기기를 사용하기 전에 추가 경고 사항에 대한 작동 설명서를 읽어 주십시오.



보호 접지 단자. 장치는 보호 접지 연결 전원 소켓 콘센트에 연결되어야

تشير لنتبيه المستخدم لوجود "تيارات كهربية خطيرة" غير معزولة داخل محتويات المنتج والتي قد تكون كافية لتسبب في تعرض الأشخاص لصدمة كهربية.

تشير لنتبيه المستخدم لوجود تعليمات تشغيل وصيانة (صيانة) مهمة داخل الكتيب المرفق مع هذا المنتج.

**تحذير:** خطر التعرض لصدمة كهربية - لا تفتح!

**تحذير:** لتقليل مخاطر التعرض لصدمة كهربية، لا تقم بإزالة الغطاء. لا توجد أجزاء قابلة للاستعمال للمستخدم بالداخل. ارجع إلى الصيانة للحصول على خدمة من الموظفين المؤهلين.

**تحذير:** لمنع حدوث صدمة كهربية أو مخاطر حريق، لا يجب تعريض هذا الجهاز للمطر أو الرطوبة، ولا يجب وضع الأشياء المملوءة بالسوائل، مثل الزهرات، فوقه. قبل استخدام هذا الجهاز، اقرأ دليل التشغيل لمزيد من التحذيرات.

قيق او ضيرأتلا لاصتا عم يئابرهكلا رايتلا ذخأم نفنم ىلإ زاہجلا الصتم نوكت نأ بجي .قيئأقولا قيضراً قطحم



## IMPORTANT SAFETY INSTRUCTIONS

**WARNING:** When using electrical products, basic cautions should always be followed, including the following:

1. Read these instructions.
2. Keep these instructions.
3. Heed all warnings.
4. Follow all instructions.
5. Do not use this apparatus near water.
6. Clean only with a dry cloth.
7. Do not block any of the ventilation openings. Install in accordance with manufacturer's instructions.
8. Do not install near any heat sources such as radiators, heat registers, stoves or other apparatus (including amplifiers) that produce heat.
9. Do not defeat the safety purpose of the polarized or grounding-type plug. A polarized plug has two blades with one wider than the other. A grounding type plug has two blades and a third grounding plug. The wide blade or third prong is provided for your safety. If the provided plug does not fit into your outlet, consult an electrician for replacement of the obsolete outlet.
10. Protect the power cord from being walked on or pinched, particularly at plugs, convenience receptacles, and the point they exit from the apparatus.
11. Only use attachments/accessories provided by the manufacturer.
12.  Use only with a cart, stand, tripod, bracket, or table specified by the manufacturer, or sold with the apparatus. When a cart is used, use caution when moving the cart/apparatus combination to avoid injury from tip-over.
13. Unplug this apparatus during lightning storms or when unused for long periods of time.
14. Refer all servicing to qualified service personnel. Servicing is required when the apparatus has been damaged in any way, such as power-supply cord or plug is damaged, liquid has been spilled or objects have fallen into the apparatus, the apparatus has been exposed to rain or moisture, does not operate normally, or has been dropped.
15. Never break off the ground pin. Write for our free booklet "Shock Hazard and Grounding." Connect only to a power supply of the type marked on the unit adjacent to the power supply cord.
16. If this product is to be mounted in an equipment rack, rear support should be provided.
17. Note for UK only: If the colors of the wires in the mains lead of this unit do not correspond with the terminals in your plug, proceed as follows: a) The wire that is colored green and yellow must be connected to the terminal that is marked by the letter E, the earth symbol, colored green or colored green and yellow. b) The wire that is colored blue must be connected to the terminal that is marked with the letter N or the color black. c) The wire that is colored brown must be connected to the terminal that is marked with the letter L or the color red.
18. This electrical apparatus should not be exposed to dripping or splashing and care should be taken not to place objects containing liquids, such as vases, upon the apparatus.
19. The on/off switch in this unit does not break both sides of the primary mains. Hazardous energy can be present inside the chassis when the on/off switch is in the off position. The mains plug or appliance coupler is used as the disconnect device, the disconnect device shall remain readily operable.
20. Exposure to extremely high noise levels may cause a permanent hearing loss. Individuals vary considerably in susceptibility to noise-induced hearing loss, but nearly everyone will lose some hearing if exposed to sufficiently intense noise for a sufficient time. The U.S. Government's Occupational Safety and Health Administration (OSHA) has specified the following permissible noise level exposures:

Duration Per Day In Hours	Sound Level dBA, Slow Response
8	90
6	92
4	95
3	97
2	100
1 1/2	102
1	105
1/2	110
1/4 or less	115

According to OSHA, any exposure in excess of the above permissible limits could result in some hearing loss. Earplugs or protectors to the ear canals or over the ears must be worn when operating this amplification system in order to prevent a permanent hearing loss, if exposure is in excess of the limits as set forth above. To ensure against potentially dangerous exposure to high sound pressure levels, it is recommended that all persons exposed to equipment capable of producing high sound pressure levels such as this amplification system be protected by hearing protectors while this unit is in operation.

**SAVE THESE INSTRUCTIONS!**



## INSTRUCCIONES IMPORTANTES PARA SU SEGURIDAD

**CUIDADO:** Cuando use productos electrónicos, debe tomar precauciones básicas, incluyendo las siguientes:

1. Lea estas instrucciones.
2. Guarde estas instrucciones.
3. Haga caso de todos los consejos.
4. Siga todas las instrucciones.
5. No usar este aparato cerca del agua.
6. Limpiar solamente con una tela seca.
7. No bloquear ninguna de las salidas de ventilación. Instalar de acuerdo a las instrucciones del fabricante.
8. No instalar cerca de ninguna fuente de calor como radiadores, estufas, hornos u otros aparatos (incluyendo amplificadores) que produzcan calor.
9. No retire la patilla protectora del enchufe polarizado o de tipo "a Tierra". Un enchufe polarizado tiene dos puntas, una de ellas más ancha que la otra. Un enchufe de tipo "a Tierra" tiene dos puntas y una tercera "a Tierra". La punta ancha (la tercera ) se proporciona para su seguridad. Si el enchufe proporcionado no encaja en su enchufe de red, consulte a un electricista para que reemplace su enchufe obsoleto.
10. Proteja el cable de alimentación para que no sea pisado o pinchado, particularmente en los enchufes, huecos, y los puntos que salen del aparato.
11. Usar solamente añadidos/accesorios proporcionados por el fabricante.
12.  Usar solamente un carro, pie, trípode, o soporte especificado por el fabricante, o vendido junto al aparato. Cuando se use un carro, tenga cuidado al mover el conjunto carro/aparato para evitar que se dañe en un vuelco. No suspenda esta caja de ninguna manera.
13. Desenchufe este aparato durante tormentas o cuando no sea usado durante largos periodos de tiempo.
14. Para cualquier reparación, acuda a personal de servicio cualificado. Se requieren reparaciones cuando el aparato ha sido dañado de alguna manera, como cuando el cable de alimentación o el enchufe se han dañado, algún líquido ha sido derramado o algún objeto ha caído dentro del aparato, el aparato ha sido expuesto a la lluvia o la humedad, no funciona de manera normal, o ha sufrido una caída.
15. Nunca retire la patilla de Tierra. Escribanos para obtener nuestro folleto gratuito "Shock Hazard and Grounding" ("Peligro de Electrocutación y Toma a Tierra"). Conecte el aparato sólo a una fuente de alimentación del tipo marcado al lado del cable de alimentación.
16. Si este producto va a ser enracado con más equipo, use algún tipo de apoyo trasero.
17. Nota para el Reino Unido solamente: Si los colores de los cables en el enchufe principal de esta unidad no corresponden con los terminales en su enchufe, proceda de la siguiente manera: a) El cable de color verde y amarillo debe ser conectado al terminal que está marcado con la letra E, el símbolo de Tierra (earth), coloreado en verde o en verde y amarillo. b) El cable coloreado en azul debe ser conectado al terminal que está marcado con la letra N o el color negro. c) El cable coloreado en marrón debe ser conectado al terminal que está marcado con la letra L o el color rojo.
18. Este aparato eléctrico no debe ser sometido a ningún tipo de goteo o salpicadura y se debe tener cuidado para no poner objetos que contengan líquidos, como vasos, sobre el aparato.
19. El interruptor de en/lejos en esta unidad no rompe ambos lados de la red primaria. La energía peligrosa puede ser presente dentro del chasis cuando el interruptor de en/lejos está en el de la posición. El tapón de la red o el acoplador del aparato son utilizados como el desconecta dispositivo, el desconecta dispositivo se quedará fácilmente operable.
20. La exposición a altos niveles de ruido puede causar una pérdida permanente en la audición. La susceptibilidad a la pérdida de audición provocada por el ruido varía según la persona, pero casi todo el mundo perderá algo de audición si se expone a un nivel de ruido suficientemente intenso durante un tiempo determinado. El Departamento para la Salud y para la Seguridad del Gobierno de los Estados Unidos (OSHA) ha especificado las siguientes exposiciones al ruido permisibles:



Duración por Día en Horas	Nivel de Sonido dBA, Respuesta Lenta
8	90
6	92
4	95
3	97
2	100
1 ½	102
1	105
½	110
¼ o menos	115

De acuerdo al OSHA, cualquier exposición que exceda los límites arriba indicados puede producir algún tipo de pérdida en la audición. Protectores para los canales auditivos o tapones para los oídos deben ser usados cuando se opere con este sistema de sonido para prevenir una pérdida permanente en la audición, si la exposición excede los límites indicados más arriba. Para protegerse de una exposición a altos niveles de sonido potencialmente peligrosa, se recomienda que todas las personas expuestas a equipamiento capaz de producir altos niveles de presión sonora, tales como este sistema de amplificación, se encuentren protegidas por protectores auditivos mientras esta unidad esté operando.

**GUARDE ESTAS INSTRUCCIONES!**

## INSTRUCTIONS IMPORTANTES DE SECURITE

**ATTENTION:** L'utilisation de tout appareil électrique doit être soumise aux précautions d'usage incluant:



1. Lire ces instructions.
2. Gardez ce manuel pour de futures références.
3. Prêtez attention aux messages de précautions de ce manuel.
4. Suivez ces instructions.
5. N'utilisez pas cette unité proche de plans d'eau.
6. N'utilisez qu'un tissu sec pour le nettoyage de votre unité.
7. N'obstruez pas les systèmes de refroidissement de votre unité et installez votre unité en fonction des instructions de ce manuel.
8. Ne positionnez pas votre unité à proximité de toute source de chaleur.
9. Connectez toujours votre unité sur une alimentation munie de prise de terre utilisant le cordon d'alimentation fourni.
10. Protégez les connecteurs de votre unité et positionnez les cablages pour éviter toutes déconnexions accidentelles.
11. N'utilisez que des fixations approuvées par le fabricant.
12.  Lors de l'utilisation sur pied ou pole de support, assurez dans le cas de déplacement de l'ensemble enceinte/support de prévenir tout basculement intempestif de celui-ci.
13. Il est conseillé de déconnecter du secteur votre unité en cas d'orage ou de durée prolongée sans utilisation.
14. Seul un technicien agréé par le fabricant est à même de réparer/contrôler votre unité. Celle-ci doit être contrôlée si elle a subit des dommages de manipulation, d'utilisation ou de stockage (humidité,...).
15. Ne déconnectez jamais la prise de terre de votre unité.
16. Si votre unité est destinée a etre montée en rack, des supports arriere doivent etre utilises.
17. Note pour les Royaumes-Unis: Si les couleurs de connecteurs du cable d'alimentation ne correspond pas au guide de la prise secteur, procédez comme suit: a) Le connecteur vert et jaune doit être connecter au terminal noté E, indiquant la prise de terre ou correspondant aux couleurs verte ou verte et jaune du guide. b) Le connecteur Bleu doit être connecter au terminal noté N, correspondant à la couleur noire du guide. c) Le connecteur marron doit être connecter au terminal noté L, correspondant à la couleur rouge du guide.
18. Cet équipement électrique ne doit en aucun cas être en contact avec un quelconque liquide et aucun objet contenant un liquide, vase ou autre ne devrait être posé sur celui-ci. 1
9. L'interrupter (on-off) dans cette unité ne casse pas les deux côtés du primaire principal. L'énergie hasardeuse peut être présente dans châssis quand l'interrupter (on-off) est dans le de la position. Le bouchon principal ou atelage d'appareil est utilisé comme le débrancher l'appareil restera facilement opérable.
20. Une exposition à de hauts niveaux sonores peut conduire à des dommages de l'écoute irréversibles. La susceptibilité au bruit varie considérablement d'un individu à l'autre, mais une large majorité de la population expérimentera une perte de l'écoute après une exposition à une forte puissance sonore pour une durée prolongée. L'organisme de la santé américaine (OSHA) a produit le guide ci-dessous en rapport à la perte occasionnée:

Durée par Jour (heures)	Niveau sonore moyen (dBA)
8	90
6	92
4	95
3	97
2	100
1 1/2	102
1	105
1/2	110
1/4 ou inférieur	115

D'après les études menées par le OSHA, toute exposition au delà des limites décrites ce-dessus entrainera des pertes de l'écoute chez la plupart des sujets. Le port de système de protection (casque, oreillette de filtrage,...) doit être observé lors de l'opération cette unité ou des dommages irréversibles peuvent être occasionnés. Le port de ces systèmes doit être observé par toutes personnes susceptibles d'être exposées à des conditions au delà des limites décrites ci-dessus.

**GARDEZ CES INSTRUCTIONS!**

## WICHTIGE SICHERHEITSHINWEISE

**SICHERHEITSHINWEISEACHTUNG:** Beim Einsatz von Elektrogeräten müssen u.a. grundlegende Vorsichtsmaßnahmen befolgt werden:

1. Lesen Sie sich diese Anweisungen durch.
2. Bewahren Sie diese Anweisungen auf.
3. Beachten Sie alle Warnungen.
4. Befolgen Sie alle Anweisungen.
5. Setzen Sie dieses Gerät nicht in der Nähe von Wasser ein.
6. Reinigen Sie es nur mit einem trockenen Tuch.
7. Blockieren Sie keine der Lüftungsöffnungen. Führen Sie die Installation gemäß den Anweisungen des Herstellers durch.
8. Installieren Sie das Gerät nicht neben Wärmequellen wie Heizungen, Heizgeräten, Öfen oder anderen Geräten (auch Verstärkern), die Wärme erzeugen.
9. Beeinträchtigen Sie nicht die Sicherheitswirkung des gepolten Steckers bzw. des Erdungssteckers. Ein gepolter Stecker weist zwei Stifte auf, von denen einer breiter ist als der andere. Ein Erdungsstecker weist zwei Stifte und einen dritten Erdungsstift auf. Der breite Stift bzw. der dritte Stift dient Ihrer Sicherheit. Sollte der beiliegende Stecker nicht in Ihre Steckdose passen, wenden Sie sich bitte an einen Elektriker, um die ungeeignete Steckdose austauschen zu lassen.
10. Schützen Sie das Netzkabel, sodass niemand darauf tritt oder es geknickt wird, insbesondere an Steckern oder Buchsen und ihren Austrittsstellen aus dem Gerät.
11. Verwenden Sie nur die vom Hersteller erhältlichen Zubehörgeräte oder Zubehörteile.
12.  Verwenden Sie nur einen Wagen, Stativ, Dreifuß, Träger oder Tisch, der den Angaben des Herstellers entspricht oder zusammen mit dem Gerät verkauft wurde. Wird ein Wagen verwendet, bewegen Sie den Wagen mit dem darauf befindlichen Gerät besonders vorsichtig, damit er nicht umkippt und möglicherweise jemand verletzt wird.
13. Trennen Sie das Gerät während eines Gewitters oder während längerer Zeiträume, in denen es nicht benutzt wird, von der Stromversorgung.
14. Lassen Sie sämtliche Wartungsarbeiten von qualifizierten Kundendiensttechnikern durchführen. Eine Wartung ist erforderlich, wenn das Gerät in irgendeiner Art beschädigt wurde, etwa wenn das Netzkabel oder der Netzstecker beschädigt wurden, Flüssigkeit oder Gegenstände in das Gerät gelangt sind, das Gerät Regen oder Feuchtigkeit ausgesetzt wurde, nicht normal arbeitet oder heruntergefallen ist.
15. Der Erdungsstift darf nie entfernt werden. Auf Wunsch senden wir Ihnen gerne unsere kostenlose Broschüre „Shock Hazard and Grounding“ (Gefahr durch elektrischen Schlag und Erdung) zu. Schließen Sie nur an die Stromversorgung der Art an, die am Gerät neben dem Netzkabel angegeben ist.
16. Wenn dieses Produkt in ein Geräte-Rack eingebaut werden soll, muss eine Versorgung über die Rückseite eingerichtet werden.
17. Hinweis – Nur für Großbritannien: Sollte die Farbe der Drähte in der Netzleitung dieses Geräts nicht mit den Klemmen in Ihrem Stecker übereinstimmen, gehen Sie folgendermaßen vor: a) Der grün-gelbe Draht muss an die mit E (Symbol für Erde) markierte bzw. grüne oder grün-gelbe Klemme angeschlossen werden. b) Der blaue Draht muss an die mit N markierte bzw. schwarze Klemme angeschlossen werden. c) Der braune Draht muss an die mit L markierte bzw. rote Klemme angeschlossen werden.
18. Dieses Gerät darf nicht ungeschützt Wassertropfen und Wasserspritzern ausgesetzt werden und es muss darauf geachtet werden, dass keine mit Flüssigkeiten gefüllte Gegenstände, wie z. B. Blumenvasen, auf dem Gerät abgestellt werden.
19. Der Netzschalter in dieser Einheit bricht beide Seiten von den primären Hauptleitungen nicht. Gefährliche Energie kann anwesend innerhalb des Chassis sein, wenn her Netzschalter im ab Position ist. Die Hauptleitungen stöpseln zu oder Gerätekupplung ist benutzt, während das Vorrichtung abschaltet, das schaltet Vorrichtung wird bleiben sogleich hantierbar ab.
20. Belastung durch extrem hohe Lärmpegel kann zu dauerhaftem Gehörverlust führen. Die Anfälligkeit für durch Lärm bedingten Gehörverlust ist von Mensch zu Mensch verschieden, das Gehör wird jedoch bei jedem in gewissem Maße geschädigt, der über einen bestimmten Zeitraum ausreichend starkem Lärm ausgesetzt ist. Die US-Arbeitsschutzbehörde (Occupational and Health Administration, OSHA) hat die folgenden zulässigen Pegel für Lärmbelastung festgelegt:

Dauer pro Tag in Stunden	Geräuschpegel dBA, langsame Reaktion
8	90
6	92
4	95
3	97
2	100
1 1/2	102
1	105
1/2	110
1/4 oder weniger	115

Laut OSHA kann jede Belastung über den obenstehenden zulässigen Grenzwerten zu einem gewissen Gehörverlust führen. Sollte die Belastung die obenstehenden Grenzwerte übersteigen, müssen beim Betrieb dieses Verstärkungssystems Ohrenstopfen oder Schutzvorrichtungen im Gehörgang oder über den Ohren getragen werden, um einen dauerhaften Gehörverlust zu verhindern. Um sich vor einer möglicherweise gefährlichen Belastung durch hohe Schalldruckpegel zu schützen, wird allen Personen empfohlen, die mit Geräten arbeiten, die wie dieses Verstärkungssystem hohe Schalldruckpegel erzeugen können, beim Betrieb dieses Geräts einen Gehörschutz zu tragen.

**BEWAHREN SIE DIESE SICHERHEITSHINWEISE AUF!**





## TÄRKEÄT TURVALLISUUSOHJEET

**VAARA:** Käytettäessä sähkölaitteita tulee aina huomioida mm. seuraavat turvallisuusohjeet:

1. Lue nämä ohjeet.
2. Säilytä nämä ohjeet.
3. Huomioi kaikki varoitukset.
4. Noudata kaikkia ohjeita.
5. Älä käytä laitetta veden lähellä.
6. Puhdista vain kuivalla kankaalla.
7. Älä tuki mitään tuuletusaukkoja. Asenna valmistajan ohjeiden mukaisesti.
8. Älä asenna lämpölähteiden, kuten pattereiden, liesien tai muiden lämpöä tuottavien laitteiden (kuten vahvistinten) lähelle.
9. Älä poista polarisoidun tai maadoitustyyppisen tulpan suojausta. Polaroidun tulpan toinen napa on leveämpi kuin toinen. Maadoitustulpassa on kaksi napaa ja kolmas maadoitusnapa. Leveä napa ja maadoitusnapa on tarkoitettu turvaamaan laitteen käyttöä. Jos mukana toimitettu tulppa ei sovi pistorasiaan, kutsu sähkömies vaihtamaan pistorasia, sillä se on vanhentunut.
10. Suojaa virtajohtoa päälle kävelemiseltä ja nipistyksestä, erityisesti pistotulppien, pistorasioiden sekä laitteen ulosvientien kohdalla.
11. Käytä vain valmistajan toimittamia lisälaitteita.
12.  Käytä vain valmistajan määrittämän tai laitteen mukana myydyn vaunun, jalustan, kolmijalan, kiinnikkeen tai pöydän kanssa. Käytettäessä vaunua liikuta vaunun ja laitteen yhdistelmää varovasti, jotta vältetään loukkaantumiset kaatumisesta johtuen.
13. Irrota laite sähköverkosta ukkosmyrskyjen aikana tai jos laitetta ei käytetä pitkään aikaan.
14. Huoltaminen tulee jättää pätevän huoltohenkilöstön tehtäväksi. Huoltoa tarvitaan, kun laite on jollakin tavoin vioittunut, esim. virtalähteen johto tai pistoke on vioittunut, laitteen sisään on joutunut nestettä tai esineitä, laite on altistettu sateelle tai kosteudelle, laite ei toimi normaalisti tai se on pudonnut.
15. Älä koskaan katkaise maadoitustustusta. Ottamalla meihin yhteyttä saat kirjasen "Sähköiskuvaara ja maadoitus". Kytke vain virtalähteeseen, joka vastaa laitteen virtajohtoon viereen merkittyä tyyppiä.
16. Jos laite kiinnitetään laiteräkkiin, tulee se tukea takaosastaan.
17. Note for UK only: If the colors of the wires in the mains lead of this unit do not correspond with the terminals in your plug, proceed as follows:
  - a) The wire that is colored green and yellow must be connected to the terminal that is marked by the letter E, the earth symbol, colored green or colored green and yellow.
  - b) The wire that is colored blue must be connected to the terminal that is marked with the letter N or the color black.
  - c) The wire that is colored brown must be connected to the terminal that is marked with the letter L or the color red.
18. Tätä sähkölaitetta ei tule altistaa nestetipoille tai roiskeille, eikä laitteen päälle saa asettaa nestettä sisältäviä esineitä, kuten maljakoita.
19. Laitteen virtakytkin ei katkaise ensiövirran molempia puolia. Laitteen sisällä voi olla vaarallinen jännite, kun virtakytkin on pois-asennossa. Virtajohto toimii pääkytkimenä, ja sen pitää olla aina käytettävissä.
20. Altistus erittäin korkeille äänitasoille voi aiheuttaa pysyvän kuulovaurion. Henkilöiden altuus melun aiheuttamille kuulovaurioille vaihtelee, mutta lähes kaikkien kuulo vaurioituu altistuttaessa riittävän kovalle melulle riittävän kauan. Yhdysvaltain hallituksen työturvallisuus- ja terveyshallinto (OSHA) on määrittänyt seuraavat hyväksyttävät melutasoaltistukset:

Kesto päivää kohti tunteina	Äänitaso dBA, hidas vaste
8	90
6	92
4	95
3	97
2	100
1 1/2	102
1	105
1/2	110
1/4 tai alle	115

OSHA:n mukaan altistus yo. tasoja korkeammalle määrälle voi aiheuttaa osittaisen kuulon menetyksen. Käytettäessä vahvistinjärjestelmää tulee kuulovaurioiden estämiseksi käyttää korvatulppia tai kuulosuojaimia, mikäli altistus ylittää yllä asetetut rajat. Jotta vältetään mahdollisesti vaarallinen altistus korkeille äänenpaineen tasolle, suositellaan, että kaikki korkeaa äänenpainetta tuottavien laitteiden, kuten tämän vahvistimen, lähistöllä olevat henkilöt suojaavat kuulonsa, kun laite on käytössä.

**SÄILYTÄ NÄMÄ OHJEET!**



## VIKTIGA SÄKERHETSINSTRUKTIONER

**WARNING:** När du använder elektriska produkter ska grundläggande försiktighetsåtgärder iakttas, inklusive följande:

1. Läs dessa instruktioner.
2. Behåll dessa instruktioner.
3. Iakttag alla varningar.
4. Följ alla instruktioner.
5. Använd inte apparaten i närheten av vatten.
6. Rengör endast med en torr trasa.
7. Blockera inte ventilationsöppningarna. Installera i enlighet med tillverkarens instruktioner.
8. Installera inte i närheten av värmekällor som radiatorer, varmluftsventiler, spisar eller andra apparater (inklusive förstärkare) som ger ifrån sig värme.
9. Motverka inte säkerhetsfunktionen hos en jordad stickkontakt. En jordad stickkontakt har två stift och metallbleck på sidorna. Metallblecket finns där för din säkerhet. Kontakta en elektriker för utbyte av det föråldrade vägguttaget om den medföljande stickkontakten inte passar i ditt vägguttag.
10. Skydda strömsladden från att klivas på eller klämmas, särskilt vid kontakten, grenuttag och platsen där den lämnar apparaten.
11. Använd enbart tillsatser/tillbehör som tillhandahålls av tillverkaren.
12.  Använd endast med en kärra, ställ, trefot, fäste eller bord i enlighet med tillverkarens specifikationer, eller som säljs tillsammans med apparaten. Var försiktig när du använder en kärra så att inga personskador uppstår på grund av att kombinationen kärra-apparat välter när den flyttas.
13. Koppla ur apparaten vid åskväder eller när den inte används under en längre tid.
14. Låt kvalificerad servicepersonal sköta all service. Service krävs om apparaten har skadats på något vis, till exempel om strömsladden eller stickkontakten har skadats, vätska har spillts eller föremål har fallit ner i apparaten, apparaten har utsatts för regn eller fukt, inte fungerar normalt eller har tappats.
15. Anslut aldrig till ojordade uttag. Skriv till oss för vårt gratishäfte "Stötrisk och jordning". Anslut endast till en strömkälla av samma typ som enhetens märkning anger (bredvid strömsladden).
16. Om produkten ska monteras i ett utrustningsrack bör bakre stöd användas.
17. Note for UK only: If the colors of the wires in the mains lead of this unit do not correspond with the terminals in your plug, proceed as follows:
  - a) The wire that is colored green and yellow must be connected to the terminal that is marked by the letter E, the earth symbol, colored green or colored green and yellow.
  - b) The wire that is colored blue must be connected to the terminal that is marked with the letter N or the color black.
  - c) The wire that is colored brown must be connected to the terminal that is marked with the letter L or the color red.
18. Denna elektriska apparat bör inte utsättas för dropp eller stänk och försiktighet bör iakttas så att inte föremål som innehåller vätskor, såsom vaser, placeras ovanpå apparaten.
19. Enhetens strömbrytare bryter inte båda sidor av strömkretsen. Farlig energi kan förekomma inuti höljet när strömbrytaren är i av-läget. Stickkontakten eller apparatkontakten fungerar som bortkopplingsenhet, bortkopplingsenheten ska hållas lättillgänglig.
20. Extremt höga ljudnivåer kan orsaka permanent hörselskada. Olika personer skiljer sig åt i benägenhet att få hörselskador av ljud, men i princip alla får hörselskador om de utsätts för tillräckligt höga ljud under tillräcklig tid. Den amerikanska regeringens arbetsskydds- och hälsoförvaltning (OSHA) har angivit följande maxnivåer för tillåten exponering för ljud:

Längd per dag i timmar	Ljudnivå dBA, långsam svarstid
8	90
6	92
4	95
3	97
2	100
1 1/2	102
1	105
1/2	110
1/4 eller mindre	115

Enligt OSHA kan exponering utöver ovanstående tillåtna gränser orsaka hörselskador. Öronproppar eller skydd för hörselgången eller över öronen måste bäras när detta förstärkarsystem används för att förebygga permanenta hörselskador, om exponeringen överskrider gränsvärdena enligt ovan. För att skydda mot potentiellt farlig exponering för höga ljudtrycksnivåer rekommenderas det att personer som exponeras för utrustning som kan producera höga ljudtrycksnivåer såsom detta förstärkarsystem skyddas med hörselskydd när enheten är i drift.

**SPARA DESSA INSTRUKTIONER!**



# VIKTIGE SIKKERHETSINSTRUKSJONER

**ADVARSEL:** Ved bruk av et elektrisk apparat må grunnleggende forsiktighetsregler følges, inklusive de følgende:

1. Les disse instruksjonene.
2. Ta vare på disse instruksjonene.
3. Følg alle advarslene.
4. Følg alle instruksjoner.
5. Ikke bruk apparatet i nærheten av vann.
6. Rengjør bare med en tørr klut.
7. Ikke blokker noen av ventilasjonsåpningene. Installer i henhold til produsentens instruksjoner.
8. Ikke installer i nærheten av en varmekilde som radiatorer, varmekanaler, ovn er eller andre apparater (inklusive forsterkere) som utvikler varme.
9. Ikke reduserer sikkerhetshensiktene med polariserte eller jordede støpsler. Et polarisert støpsel har to blader, der det ene er bredere enn det andre. Et støpsel med jording har to blader og en tredje jordingsplugg. Det brede bladet eller den tredje pluggen er der for å gi deg beskyttelse. Hvis det medfølgende støpslet ikke passer inn i den elektriske kontakten der du bor, kontakt en elektriker for å få støpslet skiftet.
10. Beskytt den elektriske ledningen mot å bli trådt på eller klemt, spesielt ved støpslet, stikkkontakten og punktet der den kommer ut av apparatet.
11.  Bruk bare tilkoblinger/tilbehør som er levert av produsenten.
12. Bruk bare med vogn, stativ, tripod, brakett eller bord spesifisert av produsenten eller solgt sammen med apparatet. Når det benyttes en vogn, vis forsiktighet når vogn/apparat flyttes for å unngå skade som følge av et velt.
13. Trekk ut ledningen til apparatet under tordenvær eller når det skal stå ubrukt over en lengre periode.
14. Overlat servicearbeidet til kvalifisert servicepersonell. Service er påkrevet når apparatet har vært utsatt for skade, som at den elektriske ledningen eller støpslet er skadet, væske er blitt sølt over apparatet eller en gjenstand har falt ned i apparatet, apparatet har vært utsatt for regn eller fuktighet, at det ikke virker normalt eller har falt i gulvet.
15. Bryt aldri av jordingspinnen. Skriv etter gratis hefte "Shock Hazard and Grounding" (Fare for elektrisk støt og jording). Tilkoble bare elektriske anlegg av den typen som er angitt på enheten ved siden av den elektriske ledningen.
16. Hvis dette produktet skal plasseres i en utstyrsreol må det etableres støtte på baksiden.
17. Note for UK only: If the colors of the wires in the mains lead of this unit do not correspond with the terminals in your plug, proceed as follows: a) The wire that is colored green and yellow must be connected to the terminal that is marked by the letter E, the earth symbol, colored green or colored green and yellow. b) The wire that is colored blue must be connected to the terminal that is marked with the letter N or the color black. c) The wire that is colored brown must be connected to the terminal that is marked with the letter L or the color red.
18. Dette elektriske apparatet må ikke utsettes for drypp eller sprut fra væske, og det må utvises forsiktighet slik at det ikke plasseres gjenstander fylt med vann - som en vase - på apparatet.
19. På/av-bryteren på denne enheten bryter ikke begge sider av den primære strømkretsen. Farlig strøm kan finnes på innsiden av chassiset også når På/Av-bryteren er i posisjon Av. Det elektriske støpslet eller utstyrskoblingen brukes som frakoblingsutstyr, frakoblingsutstyret skal være lett å komme til og bruke.
20. Eksponering mot ekstremt høyt støynivå kan føre til permanent tap av hørsel. Det er betydelige individuelle forskjeller hva gjelder den enkeltes ømfintlighet hva gjelder støypåført tap av hørsel, men nesten alle vil tape noe hørsel dersom de utsettes for tilstrekkelig intens støy over en tilstrekkelig lang periode. U.S. Governments Occupational Safety and Health Administration (OSHA) har spesifisert følgende tillatte støynivåeksponeringer:



Varighet pr. dag i timer	Lydnivå dBA, sakte respons
8	90
6	92
4	95
3	97
2	100
1 1/2	102
1	105
1/2	110
1/4 eller mindre	115

I henhold til OSHA vil enhver eksponering ut over de ovenstående tillatte grensene kunne føre til noe tap av hørsel. Ørepropper eller beskyttelse av ørekanalene eller over ørene må anvendes når dette forsterkersystemet brukes for å hindre permanent tap av hørsel dersom eksponeringen overskrider grensene som vises ovenfor. For å beskytte mot potensielt farlig eksponering til høyt lydtryknivåer anbefales det at alle personer som eksponeres mot utstyr som er i stand til å produsere høye lydtryknivåer som dette forsterkersystemet må beskyttes av hørselsvern mens denne enheten er i bruk.

**OPPBEVAR DISSE INSTRUKSJONENE**

## BELANGRIJKE VEILIGHEIDSINSTRUCTIES

**WAARSCHUWING:** Bij gebruik van elektrische producten, moeten elementaire voorzorgsmaatregelen altijd worden opgevolgd, waaronder het volgende:

1. Lees deze gebruiksaanwijzing.
2. Bewaar deze gebruiksaanwijzing.
3. Besteed aandacht aan alle waarschuwingen.
4. Volg alle instructies op.
5. Gebruik dit apparaat niet in de buurt van water.
6. Reinig het alleen met een droge doek.
7. Blokkeer geen ventilatieopeningen. Installeer volgens de instructies van de fabrikant.
8. Installeer niet in de buurt van warmtebronnen zoals radiatoren, kachels, ovens of andere apparaten (inclusief versterkers) die warmte produceren.
9. Omzeil nooit de veiligheidsvoorziening van de gepolariseerde of geaarde stekker. Een gepolariseerde stekker heeft twee bladen, waarvan er één breder is dan de andere. Een geaarde stekker heeft twee bladen en een derde aardingspen. Het bredere blad of de derde pen is bedoeld voor uw veiligheid. Mocht de geleverde stekker niet in uw stopcontact passen, raadpleeg dan een elektricien voor het vervangen van het verouderde stopcontact.
10. Bescherm het netsnoer zodat er niet over gelopen kan worden of bekneld kan raken, vooral bij stekkers, stopcontacten en het punt waar ze het apparaat verlaten.
11. Gebruik alleen aansluitstukken/accessoires geleverd door de fabrikant.
12.  Gebruik uitsluitend een wagentje, standaard, statief, beugel of tafel die door de fabrikant wordt aanbevolen of bij het apparaat wordt verkocht. Wanneer u een wagentje gebruikt, wees dan voorzichtig bij het verplaatsen van de combinatie wagen/apparaat en voorkom letsel door omvallen.
13. Haal de stekker van dit apparaat uit het stopcontact tijdens bliksem of wanneer het apparaat gedurende lange perioden niet gebruikt wordt.
14. Laat al het onderhoud uitvoeren door gekwalificeerd onderhoudspersoneel. Onderhoud is nodig wanneer het apparaat op enige wijze beschadigd is, zoals het netsnoer of de stekker is beschadigd, er vloeistof in het apparaat is gemorst of voorwerpen in zijn terechtgekomen, het apparaat aan regen of vocht is blootgesteld, niet normaal werkt, of is gevallen.
15. Breek nooit de aardingspen af. Raadpleeg ons gratis boekje "Schokgevaar en aarding". Sluit alleen op een voedingsspanning aan van het type aangegeven op het apparaat naast het netsnoer.
16. Als dit product in een apparatuurrek gemonteerd moet worden, moet voor achterondersteuning worden verzorgd.
17. Note for UK only: If the colors of the wires in the mains lead of this unit do not correspond with the terminals in your plug, proceed as follows: a) The wire that is colored green and yellow must be connected to the terminal that is marked by the letter E, the earth symbol, colored green or colored green and yellow. b) The wire that is colored blue must be connected to the terminal that is marked with the letter N or the color black. c) The wire that is colored brown must be connected to the terminal that is marked with the letter L or the color red.
18. Dit elektrisch apparaat mag niet aan drui- of spatwater worden blootgesteld en er moet op gelet worden dat geen voorwerpen gevuld met vloeistoffen, zoals vazen, op het apparaat worden geplaatst.
19. De aan/uit-schakelaar van dit apparaat onderbreekt niet beide contacten van het lichtnet. Gevaarlijke spanning kan binnenin het chassis aanwezig zijn ondanks dat de aan/uit-schakelaar op uit staat. De stekker van het apparaat wordt gebruikt als onderbrekingsmechanisme, het onderbrekingsmechanisme dient eenvoudig bedienbaar te blijven.
20. Blootstelling aan extreem hoge geluidsniveaus kan permanent gehoorverlies veroorzaken. Individuen verschillen in gevoeligheid voor gehoorverlies door lawaai geïnduceerd, maar bijna iedereen zal enig gehoor verliezen indien voor een bepaalde duur aan voldoende intens lawaai blootgesteld. De Occupational Safety and Health Administration (OSHA) van de Amerikaanse regering heeft de volgende blootstellingen aan toelaatbaar lawaainiveau gespecificeerd:

Duur per dag In uren	Geluidsniveau dBA, trage reactie
8	90
6	92
4	95
3	97
2	100
1 1/2	102
1	105
1/2	110
1/4 of minder	115

Volgens OSHA, kan elke blootstelling boven de bovengenoemde toelaatbare grenswaarden tot enige gehoorverlies leiden. Oordoppen of -beschermers in de oorkanalen of over de oren moeten bij het bedienen van dit versterkersysteem worden gedragen om een permanent gehoorverlies te voorkomen, indien blootstelling boven de grenzen zoals hierboven zijn vermeld. Om potentieel gevaarlijke blootstelling aan hoge geluidsdruk te voorkomen, is het raadzaam om alle personen die aan apparatuur worden blootgesteld die in staat is om hoge geluidsdruk te produceren, zoals dit versterkersysteem, met gehoorbeschermers te beschermen wanneer dit apparaat in bedrijf is.

**BEWAAR DEZE INSTRUCTIES!**



## IMPORTANTI NORME DI SICUREZZA:

**ATTENZIONE:** Durante uso di apparecchiature elettriche vanno osservate alcune precauzioni basilari, tra cui le seguenti:

1. Leggete queste istruzioni.
2. Conservate le istruzioni.
3. Rispettate tutte le avvertenze.
4. Seguite le istruzioni.
5. Non usate questo prodotto vicino all'acqua.
6. Pulite esclusivamente con un panno asciutto.
7. Non ostruite le fessure di ventilazione. Installate il dispositivo seguendo le istruzioni del produttore.
8. Il prodotto va collocato lontano da sorgenti di calore quali radiatori, pompe di calore, stufe o altri dispositivi che generano calore (compresi gli amplificatori).
9. Non eliminate i dispositivi di sicurezza come spine polarizzate o con messa a terra. La spina polarizzata ha due lame, una più grande dell'altra. La spina con messa a terra ha due contatti più un terzo per la terra. Il contatto più largo o terzo polo è indispensabile per la vostra sicurezza. Se la spina fornita non adatta alla vostra presa, mettetevi in contatto con un elettricista per la sostituzione della presa obsoleta.
10. Fate attenzione a non camminare o incastrare il cavo di alimentazione, soprattutto in prossimità della spina o del punto in cui si collega all'apparecchiatura.
11. Usate solo accessori originali forniti dal costruttore.
12.  L'apparato va usato esclusivamente con il supporto indicato dal produttore o venduto con l'apparato. Se intendete adoperare un carrello su ruote, fate attenzione quando spostate apparecchio e supporto per evitare che la loro caduta possa causare danni a cose o persone.
13. Scollegatelo l'apparecchio dalla presa di corrente durante un temporale con fulmini o quando non s'intende usare per un lungo periodo.
14. L'assistenza va eseguita esclusivamente da personale autorizzato. È necessario ricorrere all'assistenza se il dispositivo ha subito danni, per esempio si sono rovinati il cavo di alimentazione o la spina, all'interno è caduto del liquido o un oggetto, il dispositivo è rimasto esposto alla pioggia o all'umidità, non funziona normalmente o è caduto a terra.
15. Non rimuovete lo spinotto della terra. Collegare il dispositivo esclusivamente a una presa di corrente del tipo indicato accanto alla targhetta posta vicino al cavo di alimentazione.
16. Se questo prodotto deve essere montato a rack, è necessario sostenerlo anche nella parte posteriore.
17. Nota per UK: Se i colori dei fili nel cavo di alimentazione per questa unità non corrispondono con i terminali della vostra spina, procedere come segue: a) Il filo di colore verde/giallo deve essere collegato al terminale che marcato con lettera E, o simbolo di terra, o colore verde o verde/giallo. b) Il filo di colore blu deve essere collegato al terminale marcato con la lettera N o di colore Nero. c) Il filo di colore marrone deve essere collegato al terminale marcato con la lettera L o di colore Rosso.
18. Questo apparato elettrico non deve essere esposto a gocce o schizzi, va in ogni caso evitato di appoggiare oggetti contenenti liquidi, come bicchieri, sull'apparecchio.
19. L'interruttore on/off in questa unità non interrompe entrambi i lati della rete di alimentazione. All'interno dell'apparecchio può essere presente elettricità anche con interruttore on/off in posizione off. La spina o il cavo di alimentazione è utilizzato come sezionatore, il dispositivo di sezionamento deve restare sempre operativo.
20. L'esposizione a livelli di volume molto elevati può causare la perdita permanente dell'udito. La predisposizione alla perdita dell'udito causata da livelli elevati di volume varia notevolmente da persona a persona, ma quasi tutti subiscono una perdita di udito almeno parziale se soggetti a volume di livello elevato per un tempo sufficientemente lungo. L'ufficio Lavoro e Salute del governo degli USA (OSHA) ha elaborato la seguente tabella di tolleranza ai rumori:



Esposizione giornaliera in ore	Livello sonoro dBA, Slow response
8	90
6	92
4	95
3	97
2	100
1 1/2	102
1	110
1/4 o minore	115

Secondo l'OSHA, l'esposizione a livelli di volume al di sopra dei limiti stabiliti può causare una perdita almeno parziale dell'udito. Quando si adoperava questo sistema di amplificazione, è necessario indossare auricolari o apposite protezioni per il condotto auditivo, per evitare la perdita permanente dell'udito se l'esposizione supera i limiti sopra riportati. Per evitare di esporvi al rischio di danni derivanti da elevati livelli di pressione sonora, si raccomanda di adoperare delle protezioni per gli orecchi quando si usano attrezzature in grado di produrre elevati livelli sonori, come quest'amplificatore.

**CONSERVATE QUESTE ISTRUZIONI!**

## INSTRUÇÕES IMPORTANTES DE SEGURANÇA

**ADVERTÊNCIA:** Ao usar eletrodomésticos, precauções básicas devem sempre ser seguidas, incluindo as seguintes:

1. Leia estas instruções.
2. Mantenha estas instruções.
3. Preste atenção a todas as advertências.
4. Siga todas as instruções.
5. Não use este aparelho perto d'água.
6. Limpe somente com um pano seco.
7. Não obstrua nenhuma das aberturas de ventilação. Instale de acordo com as instruções do fabricante.
8. Não instale perto de nenhuma fonte de calor tais como radiadores, registros de calor, fogões ou outros aparelhos (incluindo amplificadores) que produzam calor.
9. Não desafie o propósito de segurança do plugue polarizado ou do tipo aterrado. Um plugue polarizado tem duas lâminas com uma mais larga que a outra. Um plugue do tipo aterrado tem duas lâminas e um terceiro plugue terra. A lâmina larga ou o terceiro pino são fornecidos para sua segurança. Se o plugue disponibilizado não couber em sua tomada, consulte um electricista para troca da tomada obsoleta.
10. Proteja o cabo de energia para não ser pisado ou espremido principalmente em plugues, recipientes e o ponto de onde sai do aparelho.
11. Use apenas conexões/acessórios fornecidos pelo fabricante.
12.  Use apenas um carrinho, banquetas, tripé, suporte, ou mesa especificado pelo fabricante, ou vendido com o aparelho. Quando um carrinho for usado, tome cuidado ao mover a combinação carrinho/aparelho para evitar ferimentos por tombamento.
13. Tire esse aparelho da tomada durante tempestades de raios ou quando for ficar sem usar por longos períodos de tempo.
14. Entregue todos os consertos apenas a pessoal qualificado. O conserto é necessário quando o aparelho tiver sofrido qualquer dano, tais como o cabo de energia ou plugue estiverem danificados, líquidos tenham sido derramados ou objetos tenham caído no aparelho, o aparelho tenha sido submetido à chuva ou umidade, não funcionar normalmente, ou tenha sido deixado cair.
15. Nunca quebre fora o pino terra. Escreva pedindo nosso livreto grátis "Perigos de Choque e Aterramento." Ligue apenas a um suprimento de energia do tipo marcado na unidade adjacente ao fio de fornecimento de energia.
16. Se este produto for ser montado em uma estante para equipamentos, deve ser montado um suporte traseiro.
17. Note for UK only: If the colors of the wires in the mains lead of this unit do not correspond with the terminals in your plug, proceed as follows:
  - a) The wire that is colored green and yellow must be connected to the terminal that is marked by the letter E, the earth symbol, colored green or colored green and yellow.
  - b) The wire that is colored blue must be connected to the terminal that is marked with the letter N or the color black.
  - c) The wire that is colored brown must be connected to the terminal that is marked with the letter L or the color red.
18. Este aparelho elétrico não deve ser exposto a pingos ou respingos e deve ser tomado cuidado para não colocar objetos contendo líquidos, tais como vasos, sobre o aparelho.
19. O comutador liga/desliga nesta unidade não interrompe ambos os lados da rede elétrica primária. Energia perigosa pode estar presente dentro do chassi quando o comutador liga/desliga estiver na posição desligado. O plugue de alimentação ou um dispositivo de união é usado como dispositivo de desligamento, o dispositivo de desligamento deve permanecer pronto para funcionar.
20. Exposição a níveis de barulho extremamente altos podem causar perda permanente de audição. As pessoas variam consideravelmente em susceptibilidade a perda de audição causada por ruídos, mas quase todo mundo vai perder algo da audição se exposto a ruído suficientemente intenso por tempo suficiente. A Administração de Segurança Ocupacional e Saúde americana (OSHA) especificou os seguintes níveis permissíveis de exposição a ruído:



Duração Por Dia Em Horas	dBA de Nível de Som, Resposta Lenta
8	90
6	92
4	95
3	97
2	100
1 1/2	102
1	105
1/2	110
1/4 ou menos	115

De acordo com a OSHA, qualquer exposição excedente aos limites permissíveis acima pode resultar em alguma perda de audição. Tampões de ouvido ou protetores sobre os canais do ouvido ou sobre as orelhas precisam ser usados ao operar este sistema de amplificação para poder evitar uma perda permanente de audição, se a exposição for em excesso aos limites acima estabelecidos. Para assegurar contra exposição perigosa potencial a níveis de alta pressão de ruído, é recomendado que todas as pessoas expostas a equipamento capaz de produzir níveis de alta pressão de ruído tais como este sistema de amplificação estejam protegidas por protetores de ouvido enquanto esta unidade estiver em funcionamento.

**GUARDE ESSAS INSTRUÇÕES!**

## 安全のための重要事項

警告: 電気製品を使用するときは、次の項目を含め、基本的な注意事項を常にお守りください。

CE

1. 本書の指示内容をお読みください。
2. 本書は保管してください。
3. すべての警告に注意してください。
4. すべての指示に従ってください。
5. 本装置を水の近くで使用しないでください。
6. お手入れには乾いた布をお使いください。
7. 開口部をふさがないでください。メーカーの指示に従って設置してください。
8. ラジエータ、ストーブなど (アンプを含む)、発熱体の近くに設置しないでください。
9. 分極プラグや接地プラグの安全性を損なわないようにしてください。分極プラグの2つのブレードは、一方が他より幅広くなっています。接地式のプラグには2つのブレードと接地プラグがあります。幅広のブレードや接地プラグは安全のために付けられています。所定のプラグがコンセントなどに合わない場合、旧式のコンセントなどの交換について技術者に問い合わせてください。
10. 電源コードを踏んだり挟んだりしないように保護してください。特にプラグ、コンセント、装置から出る部分を保護してください。
11. 備品/付属品はメーカーのものを使用してください。
12.  カート、スタンド、三脚、ブラケット、テーブルなどは、メーカー指定のもの、または装置とともに販売されているものを使用してください。カートを使用するときは、カートと装置を動かしたときに横転などでケガをしないよう注意してください。
13. 落雷の恐れのある嵐のとき、または長期間使用しないときは本装置の電源を外してください。
14. 保守作業はすべて資格のあるサービス担当者に依頼してください。保守作業が必要になるのは、装置が故障した場合、たとえば、電源コードやプラグが破損、装置に液体がかかる。物が落ちる、雨など湿度の影響を受ける、正常に動作しない、落下した場合などです。
15. グランドピン (接地ピン) は決して取り外さないでください。フリーブックレット「感電と接地」を入手してください。装置の電源コードの横に記載されているタイプの電源にのみ接続してください。
16. 本製品をラックに載せる場合は、背面を支持するものがが必要です。
17. Note for UK only: If the colors of the wires in the mains lead of this unit do not correspond with the terminals in your plug, proceed as follows: a) The wire that is colored green and yellow must be connected to the terminal that is marked by the letter E, the earth symbol, colored green or colored green and yellow. b) The wire that is colored blue must be connected to the terminal that is marked with the letter N or the color black. c) The wire that is colored brown must be connected to the terminal that is marked with the letter L or the color red.
18. 電気機器に水がかからないようにしてください。花瓶など液体の入ったものを装置に置かないように注意してください。
19. オン/オフスイッチは、主電源のどちらの側も切断しません。オン/オフスイッチがオフ位置のとき、シャシー内部のエネルギー (高電圧) は危険なレベルにあります。主電源プラグまたは機器のカプラが切断装置になっています。切断装置はすぐに動作し使用できる状態にしておく必要があります。
20. 極めて高い騒音レベルは聴覚を永久に損なう原因になることがあります。騒音による聴覚障害の可能性は人によって異なりますが、十分に高い騒音を十分長い時間浴びた場合には、ほぼすべての人が何らかの障害を被ります。米国労働安全衛生庁 (OSHA) は、許容できるノイズレベル (騒音暴露レベル) を次のように定めています。

1日当たりの時間	サウンドレベルdBA、スローレスポンス
8	90
6	92
4	95
3	97
2	100
1½	102
1	105
½	110
¼ 以下	115

OSHAによると、上記許容限度を超える場合は聴覚障害の原因になります。騒音が上記限度を超える場合は、永久的な聴覚障害を避けるため、このアンプシステムの操作時に、外耳道または耳全体にイヤプラグやプロテクタを装着する必要があります。高音圧レベルによる危険な状態を避けるため、このアンプシステムのような高音圧レベルを出力する機器に触れる人はすべて、本機を使用中はプロテクタにより聴覚を保護することをおすすめします。

**本書は保管してください!**

## 重要安全事项

**警告：**操作电器产品时，请务必遵守基本安全注意事项，包括：

1. 阅读说明书。
2. 妥善保管说明书。
3. 注意所有安全警告。
4. 按照要求和指示操作。
5. 请勿在靠近水（或其它液体）的地方使用本机。
6. 本机只能用干燥布料擦拭。
7. 请勿遮盖任何通散热口。确实依照本说明书安装本机。
8. 请勿将本机安装在任何热源附近，例如电暖器、蓄热器件、火炉或其他发热电器（包括功率放大器）。
9. 请勿破坏两脚型插头或接地型插头的安全装置。两脚型插头有两个不同宽度的插头片，一个窄，另一个宽一点。接地型插头有两个相同的插头片和一个接地插脚。两脚型插头中宽的插头片和接地型插头接地插脚起着保障安全的作用。如果所附带的插头规格与您的插座不匹配，请让电工更换插座以保证安全。
10. 请勿踩踏或挤压电源线，尤其是插头、插座、设备电源输入接口或者电源线和机身连接处。
11. 本机只可以使用制造商指定的零件 / 配件。
12.  本机只可以使用与本机搭售或由制造商指定的机柜、支架、三角架、托架或桌子。使用机柜时，请小心移动已安装设备的机柜，以避免机会推翻造成身体伤害。
13. 在雷雨天或长期不使用的情况下，请拔掉电源插头。
14. 所有检查与维修都必须由指定的专业维修人员进行。如本机的任何形式的损伤都须检修，例如电源线或插头受损，有液体或物体落入机身内，曾暴露于雨天或潮湿的地方，不能正常运作，或曾掉落后损坏等。
15. 不得拔出接地插脚。请写信索取免费手册《Shock Hazard and Grounding》。使用前，请仔细检查确认所使用的电源电压是否匹配设备上标注的额定电压。
16. 如果本机装在机柜中，其后部也应给予相应的支撑固定。
17. **Note for UK only:** If the colors of the wires in the mains lead of this unit do not correspond with the terminals in your plug, proceed as follows:
  - a) The wire that is colored green and yellow must be connected to the terminal that is marked by the letter E, the earth symbol, colored green or colored green and yellow.
  - b) The wire that is colored blue must be connected to the terminal that is marked with the letter N or the color black.
  - c) The wire that is colored brown must be connected to the terminal that is marked with the letter L or the color red.
18. 本机不得暴露于滴水或溅水中。请勿将诸如花瓶等装有液体的物体放置于本机上。
19. 本机电源开关不能同时断开两端的电源，完全切断外部电源。因此当开关位于“OFF”位置时，本机外壳仍有可能带有触电的危险。电源插头或耦合器能够与设备或者电源容易分开，保证电源的完全切断，从而保证安全。
20. 声压级较高的噪音容易造成听力的永久性损失。因噪声而造成的听力损失程度，个体间的差异较大，但几乎每个人在声压级较高的噪音环境里一定时间，都会有不同程度的听力损失。美国政府职业安全与保健管理局（OSHA）就此规定了下列容许噪声级：

每天持续小时数	声压级 (dBA) 慢反应
8	90
6	92
4	95
3	97
2	100
1½	102
1	105
½	110
¼ 或更少	115

据 OSHA, 任何超出以上所允许的范围, 都会造成部分听力的损失。使用本功放系统时, 必须佩戴如耳塞等保护耳朵的器件, 防止长时间处于上述限制级以上的环境而引起永久性听力受损。本机运行时, 如果超过上述所规定的最大限制, 为了抵御较高的声压对于听受损所造成的潜在危险, 建议使用诸如功放系统等引起高声压级噪声的所有人均佩戴保护耳朵的器件。

**请妥善保管本说明书!**





## 중요 안전 지침

**경고:** 전기 제품 사용 시 다음 사항을 포함해 기본적인 주의 사항을 항상 따라야 합니다.

1. 이 지침을 읽어 주십시오.
2. 이 지침을 준수하여 주십시오.
3. 모든 경고 사항에 주의해 주십시오.
4. 모든 지침을 따라 주십시오.
5. 물기가 있는 근처에서 이 기기를 사용하지 마십시오.
6. 다른 형식으로만 청소해 주십시오.
7. 통풍구를 막지 마십시오. 제조업체의 지침에 따라 설치해 주십시오.
8. 라디에이터, 가열기, 난로 또는 열을 발산하는 기타 기기(앰프 포함) 근처에 설치하지 마십시오.
9. 극성 플러그나 접지형 플러그의 안전 용도를 무시하지 마십시오. 극성 플러그는 한쪽 날이 다른 쪽보다 더 넓습니다. 접지형 플러그에는 2개의 날과 1개의 접지 플러그가 있습니다. 넓은 날 또는 1개의 접지 플러그는 안전을 위해 제공됩니다. 제공된 플러그가 사용자의 콘센트에 맞지 않으면 구식 콘센트의 교체에 대해 전기 기술자에게 문의하십시오.
10. 전원 코드 특히, 플러그, 소켓 및 기기에서 나오는 지점이 밟히거나 잡히지 않도록 보호하십시오.
11. 제조업체에서 제공하는 부착 장치/액세서리만을 사용하십시오.
12.  제조업체에서 지정하거나 기기와 함께 판매되는 카트, 스탠드, 삼각대, 브래킷 또는 테이블만을 사용하십시오. 카트 사용 시 카트/기기 결합부를 움직일 때 전복으로 인해 부상을 입지 않도록 주의해 주십시오.
13. 번개와 폭풍이 올 때 그리고 장기간 사용하지 않을 때는 이 기기의 플러그를 뽑아 놓으십시오.
14. 자격을 갖춘 서비스 요원에게 모든 서비스를 의뢰하십시오. 전원 공급 코드 또는 플러그가 손상되거나 액체를 엮지르거나 기 안에 이물질이 떨어뜨리거나 비 또는 습기에 기기를 노출하거나 정상적으로 작동하지 않거나 기기를 떨어뜨린 경우와 같이 기기가 손상된 경우에는 서비스를 받아야 합니다.
15. 접지 핀을 제거하지 마십시오. 당사의 무료 소책자인 “감전 위험 및 접지”을 우편으로 주문해 주십시오. 전원 공급 코드의 기기에 표시된 유형의 전원 공급 장치만 연결해 주십시오.
16. 이 제품을 장비 랙에 장착할 경우에는 후면 지지대를 설치해야 합니다.
17. **Note for UK only:** If the colors of the wires in the mains lead of this unit do not correspond with the terminals in your plug, proceed as follows: a) The wire that is colored green and yellow must be connected to the terminal that is marked by the letter E, the earth symbol, colored green or colored green and yellow. b) The wire that is colored blue must be connected to the terminal that is marked with the letter N or the color black. c) The wire that is colored brown must be connected to the terminal that is marked with the letter L or the color red.
18. 전기 기기가 비나 물방울에 노출되지 않도록 주의하고 꽃병과 같이 용액이 들어 있는 물체를 기기 위에 놓지 않도록 주의해 주십시오.
19. 본 기기의 ON/OFF 스위치는 양쪽의 주 기기 전원을 차단하지 않습니다. ON/OFF 스위치가 OFF 위치에 있더라도 새시 내부에 위험한 전기가 흐를 수 있습니다. 기본 플러그 또는 기기 커플러는 분리 장치로 사용됩니다. 분리 장치는 바로 사용 가능한 상태로 두어야 합니다.
20. 매우 높은 소음에 노출되면 영구적으로 청각이 손상될 수 있습니다. 소음으로 인한 청각 손상 가능성은 개인별로 매우 다르지만 장시간 매우 강한 소음에 노출되면 거의 모든 사람들에게 어느 정도의 청각 손상이 발생합니다. 미국 정부의 OSHA(작업 안전 및 건강 관리국)은 다음과 같이 용인 가능한 소음 노출을 규정하고 있습니다.

일별 지속 시간	소음 수준 dBA, 저속 반응
8	90
6	92
4	95
3	97
2	100
1½	102
1	105
½	110
¼ 이하	115

OSHA에 따르면 용인 가능한 위 제한 수치를 초과하여 노출된 경우 일부 청각이 손상될 수 있습니다. 위에 명시된 제한치를 초과하여 노출되는 경우 영구적인 청각 손상을 예방하려면 이 앰프 시스템 사용 시 귀마개 또는 귀 전체를 덮는 보호구를 착용해야 합니다. 잠재적으로 위험한 높은 음압에 노출되지 않도록 하려면 이 앰프 시스템과 같이 높은 음압을 생성할 수 있는 장비에 노출되는 모든 사람이 기기가 작동하는 동안 청각 보호구를 착용하는 것이 좋습니다.

**이 지침을 잘 보관해 주십시오**

CE

## تعليمات الأمان المهمة

تحذير: عند استخدام المنتجات الكهربائية، يجب اتباع الاحتياطات الأساسية دائما، والتي تشمل التالي:

CE

1. قراءة هذه التعليمات.
2. الحفاظ على هذه التعليمات.
3. الانتباه لجميع التحذيرات.
4. اتباع هذه التعليمات.
5. عدم استخدام هذا الجهاز على مقربة من الماء.
6. ينظف فقط بقطعة قماش جافة.
7. لا تقم بسد أي فتحات تهوية. يتم التثبيت وفقا لتعليمات المصنع.
8. لا تضع الجهاز بالقرب من أي مصادر حرارة مثل المبردات، والمدفآت، أو المواقد أو أي أجهزة أخرى (بما فيها مكبرات الصوت) التي يصدر عنها حرارة.
9. لا تتسبب في فشل الغرض من أمان قابس الكهرباء القطبي أو من النوع الأرضي. القابس القطبي به سنان أحدهما أعرض من الثاني. القابس من النوع الأرضي به سنان وقابس أرضي ثالث. القابس مزود بسن عريضة أو يتم توفير السن الثالث من أجل سلامتك. إذا لم يناسب القابس الثالث مقيس الحائط الخاص بك، استشر فني كهرباء لاستبدال المقيس القديم.
10. قم بحماية كبل الكهرباء من المشي عليه أو ضغطه، خاصة في القوابس، والمقابس الملائمة، وموضع خروجها من الجهاز.
11. استخدم المرفقات / الملحقات المقدمة من المصنع فقط.
12. استخدمه فقط مع الحامل، والمنضدة، والمحمل، والمسند، أو الطاولة التي حددها المصنع، أو التي تباع مع الجهاز. عند استخدام العربية، خذ حذر عند تحريك العربية / مجموعة الجهاز لتجنب إصابتك عند الانقلاب.
13. انزع قابس الجهاز أثناء عواصف البرق أو عند عدم استخدامه لفترات طويلة.
14. ارجع في جميع أعمال الصيانة للموظفين المؤهلين. يجب إجراء الصيانة عند تعرض الجهاز للتلف بأي طريقة، مثل تلف كبل مزود الكهرباء أو القابس، أو عند سقوط سائل أو أشياء على الجهاز، أو عند تعرض الجهاز للمطر أو للرطوبة، أو إذا لم يعمل بصورة طبيعية، أو في حالة سقوطه على الأرض.
15. لا تقم أبداً بقطع الموصل الأرضي. راسلنا للحصول على كتيب "خطر الإصابة بالصواعق والأطراف الكهربائية الأرضية" المجاني الخاص بنا. وصل الجهاز فقط بمزود كهرباء من النوع المحدد على الوحدة المجاورة لكبل مزود الطاقة.
16. يجب توفير الدعم الخلفي عند تركيب الجهاز على رف معدات.
17. ملاحظة للمملكة المتحدة فقط: إذا كانت ألوان الأسلاك في الأطراف الرئيسية لهذه الوحدة لا تتوافق مع العلامات الملونة المحددة للأطراف في المقيس الخاص بك، اتبع ما يلي:
  - (أ) يجب توصيل السلك الملون بالأخضر والأصفر بالطرف المميز بالحرف E، أو رمز الأرضي أو الملون بالأخضر أو الأصفر.
  - (ب) يجب توصيل السلك الملون باللون الأزرق بالطرف المميز بالحرف N، أو ذو اللون الأسود.
  - (ج) يجب توصيل السلك الملون بالبنّي بالطرف المميز بالحرف L، أو ذو اللون الأحمر.
18. لا يجب تعريض هذا الجهاز الكهربائي لتنقيط أو رش السوائل، كما يجب العناية به بعدم وضع الأشياء التي تحتوي على سوائل، مثل الزهريات، فوق الجهاز.
19. لا يعطل مفتاح التشغيل/الإيقاف بهذه الوحدة جانبي الأطراف الرئيسية الأولية. قد توجد شحنات كهربائية خطيرة داخل هيكل الجهاز عندما يكون مفتاح التشغيل/الإيقاف في وضع الإيقاف. يتم استخدام قابس الأطراف الرئيسية أو وصلة الجهاز كجهاز قطع الاتصال، الذي يجب أن يظل قابل للتشغيل.
20. قد يسبب التعرض لمستويات ضوضاء عالية جدا إلى فقدان سمع دائم. يختلف الأشخاص في مدى حساسيتهم للضوضاء التي تؤدي لفقدان السمع لحد بعيد، لكن تقريبا قد يفقد الشخص بعض من سمعه إذا تعرض لقدر كافي من الضوضاء الشديدة وذلك لوقت كافي. وقد حددت إدارة الصحة والأمان المهني بالحكومة الأمريكية مستوى التعرض المسموح به للضوضاء:

المدة يوميا بالساعات	مستوي الصوت بالديسيبل، الاستجابة التدرجية
8	90
6	92
4	95
3	97
2	100
2/1 1	102
1	105
2/1	110
4/1 أو أقل	115

وفقا لإدارة الصحة والأمان المهني، فإن أي تعرض أعلى من الحدود المسموح بها يمكن أن يؤدي إلى فقدان جزئي للسمع. يجب ارتداء سدادات الأذن أو واقبات قنوات الأذن أو فوق الأذن عند تشغيل أنظمة تكبير الصوت وذلك لمنع فقدان السمع الدائم، إذا كان التعرض يزيد على الحدود التي تم عرضها في النقطة الرابعة أعلاه. للضمان من التعرض للخطر المحتمل لمستويات ضغط صوتي عالية، ينصح جميع الأشخاص المعرضين لمعدات قادرة على إصدار مستويات ضغط صوتي عالية مثل أنظمة مكبرات الصوت أن يستخدموا واقبات الأذن لحمايتهم أثناء التشغيل.

**احفظ هذه التعليمات!**

 Logo referenced in Directive 2002/96/EC Annex IV (OJ(L)37/38, 13.02.03 and defined in EN 50419: 2005

The bar is the symbol for marking of new waste and is applied only to equipment manufactured after 13 August 2005

Correct Disposal of this product. This marking indicates that this product should not be disposed with other household wastes throughout the EU. To prevent possible harm to the environment or human health from uncontrolled waste disposal, recycle it responsibly to promote the sustainable reuse of material resources. To return your used device, please use the return and collection systems, or contact the retailer where the product was purchased. They can take this product for environmental safe recycling.

 Logo de referencia en la Directiva 2002/96/CE Anexo IV (DO (L) 37/38, 13/02/03 y definido en la norma EN 50419: 2005

El bar es el símbolo de marcado de los nuevos residuos y se aplica sólo a los equipos fabricados después del 13 de agosto 2005

Eliminación correcta de este producto. Esta marca indica que este producto no debe eliminarse junto con otros residuos que se encuentran en toda la UE. Para evitar posibles daños al medio ambiente o a la salud humana eliminación incontrolada de residuos, su reciclaje de forma responsable para promover la reutilización sostenible de recursos materiales. Para devolver el dispositivo utilizado, por favor use el regreso y los sistemas de recogida, o póngase en contacto con el establecimiento donde se adquirió el producto. Se puede tomar este producto para el reciclaje seguro ambiental.

 Logo référencé dans la directive 2002/96/CE Annexe IV (JO (L) 37/38, 13/02/03 et définie dans la norme EN 50419: 2005

Le bar est le symbole pour le marquage de nouveaux déchets et il est appliqué uniquement aux équipements fabriqués après le 13 août 2005

Élimination correcte de ce produit. Ce marquage indique que ce produit ne doit pas être jeté avec les autres déchets de prise de maison dans toute l'UE. Pour prévenir les dommages possibles pour l'environnement ou la santé humaine élimination incontrolée des déchets, le recycler de façon responsable pour promouvoir la réutilisation durable des ressources matérielles. Pour revenir sur votre appareil utilisé, s'il vous plaît utiliser les systèmes de retour et de collecte, ou contactez le revendeur où le produit a été acheté. Ils peuvent prendre ce produit pour un recyclage sûr l'environnement.

 Logo der Richtlinie 2002/96/EG Anhang IV (ABl. (L) 37/38, 13.02.03 verwiesen und definiert in EN 50419: 2005

Die Bar ist das Symbol für die Markierung von neuen Abfall und ist nur für Geräte, die nach dem 13. August 2005 hergestellt angewendet

Korrekte Entsorgung dieses Produkts. Diese Markierung zeigt an, dass dieses Produkt nicht mit anderen Haus halten Abfälle in der gesamten EU entsorgt werden. Um mögliche Schäden für die Umwelt oder die menschliche Gesundheit nicht durch unkontrollierte Abfallentsorgung, Recycling es um die nachhaltige Wiederverwertung von stofflichen Ressourcen zu fördern. Für die Rückgabe Ihres Gerätes verwenden Sie bitte das Rückgabe- und Sammelsysteme, oder kontaktieren Sie den Händler, bei dem die Ware gekauft wurde. Sie können dieses Produkt für die Umwelt recyceln können.

 Logo viitataan direktiivin 2002/96/EY liitteen IV (EUVL (L) 37/38, 13.02.03 ja määritetty EN 50419: 2005

Baari on symboli merkintä uutta jätettä ja käytetään vain laitteita valmistetaan 13. elokuuta 2005 jälkeen

Hävittäminen tästä tuotteesta. Tämä merkintä tarkoittaa, että tuotetta ei tule hävittää muun talo pitää jätteitä kaikkialla EU: ssa. Ehkäistä mahdollista haittaa ympäristölle tai ihmisten terveydelle haitat, kierrätettävä asianmukaisesti edistää kestävä materiaalien uudelleenkäyttöä. Palauttaaksesi käytetty laite, käytä keräys- tai palautuspisteeseen, tai ota yhteyttä jälleenmyyjään, jolta tuote on ostettu. He voivat käyttää tätä tuotetta ympäristön turvallinen kierrätys.

 Logo refereras i direktiv 2002/96/EG bilaga IV (EGT (L) 37/38, 13.02.03 och som definieras i EN 50419: 2005

Baren är symbolen för märkning av nytt avfall och är endast tillämpas på utrustning som tillverkats efter 13 augusti 2005

Korrekt avfallshandtering av denna produkt. Denna märkning anger att produkten inte ska kastas med annat avfall hus håll i hela EU. För att förhindra eventuell skada på miljön eller människors hälsa på grund av okontrollerad avfallshandtering, återvinning ansvarsfullt sätt som främjar en hållbar återanvändning av materiella resurser. För att återgå din begagnade enhet, använd retur- och insamlingsystem, eller kontakta återförsäljaren där produkten köptes. De kan ta detta läkemedel för miljö- och återvinning.

 Logo fa riferimento alla direttiva 2002/96/CE, allegato IV (GU (L) 37 / 38, 13.02.03 e definito in EN 50419: 2005

Il bar è il simbolo per la marcatura di nuovi rifiuti e si applica solo alle apparecchiature fabbricate dopo il 13 agosto 2005

Lo smaltimento corretto di questo prodotto. Questo marchio indica che il prodotto non deve essere smaltito con altri rifiuti casa tenere tutta l'UE. Per evitare eventuali danni all'ambiente o alla salute umana smaltimento dei rifiuti, riciclare è responsabile per favorire il riutilizzo sostenibile delle risorse materiali. Per restituire il dispositivo utilizzato, si prega di utilizzare il servizio di raccolta e, o contattare il rivenditore presso il quale è stato acquistato il prodotto. Possono prendere questo prodotto per l'ambiente riciclaggio sicuro.

## FCC Compliancy Statement

This device complies with Part 15 of the FCC rules. Operation is subject to the following two conditions: (1) this device may not cause harmful interference, and (2) this device must accept any interference received, that may cause undesired operation.

**Warning:** Changes or modifications to the equipment not approved by Peavey Electronics Corp. can void the user's authority to use the equipment.

**Note** - This equipment has been tested and found to comply with the limits for a Class B digital device, pursuant to Part 15 of the FCC Rules. These limits are designed to provide reasonable protection against harmful interference in a residential installation. This equipment generates, uses and can radiate radio frequency energy and, if not installed and used in accordance with the instructions, may cause harmful interference to radio communications. However, there is no guarantee that interference will not occur in a particular installation. If this equipment does cause harmful interference to radio or television reception, which can be determined by turning the equipment off and on, the user is encouraged to try and correct the interference by one or more of the following measures.

- Reorient or relocate the receiving antenna.
- Increase the separation between the equipment and receiver.
- Connect the equipment into an outlet on a circuit different from that to which the receiver is connected.
- Consult the dealer or an experienced radio/TV technician for help.

### Responsible Party:

Peavey Electronics Corporation • 5022 Hartley Peavey Drive • Meridian, MS • 39305  
(601) 483-5365 • FAX (601) 486-1278 • www.peavey.com • 80305780 • ©2011



# PV<sup>®</sup> i 6500

## Powered Mixers

# ENGLISH

Congratulations on the purchase of your new PV powered mixer from Peavey<sup>®</sup>. The Peavey PV<sup>®</sup> i 6500 is a revolutionary all in one powered mixer. It provides everything a musician needs including up to six combination XLR and 1/4" inputs using Peavey's award winning mic preamps, and 400 watts of peak power for crystal clear audio reproduction. The Peavey PV<sup>®</sup> i 6500 uses exclusive and patented features like Mid Morph<sup>®</sup> to accurately help improve tone and clarity of vocals. Feedback is quickly and easily identified and removed with Peavey's 9 band graphic EQ combined with our patented revolutionary FLS<sup>®</sup> Feedback Locating System. The PV<sup>®</sup> i 6500 is equipped with Peavey's exclusive Kosmos<sup>®</sup>-C technology, which drastically enhances both the low and high end of the audio spectrum. Footswitchable, built-in 24-bit digital effects complement the already feature packed unit. Connect almost anything to this versatile mixer via the onboard 1/4", RCA and 1/8" mini jacks. The PV<sup>®</sup> i 6500 includes a dock that allows the users to remotely play and pause pre-recorded music.

Before you begin using your powered mixer it is very important to ensure that the product has the proper AC voltage supplied. You can find the proper voltage for your amp printed next to the IEC line (power) cord on the rear panel of the unit.



### FEATURES:

- FLS Feedback Locating System
- Mid-Morph EQ
- Kosmos-C
- On-board 24-bit digital effects with mute button
- Digital effects parameter control
- Combination XLR and 1/4" input jacks
- 9-Band Graphic EQ with FLS
- Master Mute for channels 1-5
- Footswitchable effects defeat
- 15 Volt Phantom Power
- RCA, 1/8" Media input
- Selectable Main or Monitor dual power section
- RCA Record outputs
- LED Meter bridge
- Power amp sub-sonic filtering
- Clip light and signal presence indicator
- Main line level 1/4" output
- DDT<sup>™</sup> Speaker protection circuit
- SD card & USB MP3 player
- Bluetooth<sup>®</sup> player



**VENTILATION:** For proper ventilation, allow 6" (15.5 cm) clearance on all sides.

## CHANNEL CONTROLS

- 1 **HIGH EQ**  
This High EQ shelving type of active tone control varies the treble frequencies (+/- 15dB at 12kHz) and is designed to remove noise or add brilliance to the signal, depending on the quality of the source.
- 2 **MID-MORPH® EQ**  
Where most mid-range controls work at just one frequency, the Mid-Morph works at two. When turned counterclockwise, it cuts at 250 Hz to reduce frequencies that muddy the sound. When turned clockwise, it boosts at 4 kHz to add intelligibility to vocals. Either way, improved vocal or instrument definition can be achieved.
- 3 **LOW EQ**  
A shelving type of EQ that varies the bass frequency levels (+/- 15dB at 80Hz). Low EQ adds depth to thin-sounding signals or cleans up the muddy ones. As with any EQ, use sparingly. Too much of this EQ can give you a booming bottom end.
- 4 **EFX - DIGITAL EFFECTS**  
This control adjusts the level of the channel signal added to the effects mix. The signal is sent to the internal effects processor. Turning the knob to the left (0) will turn off effects on the associated channel, while turning the knob to the right will increase the amount of the selected effect.
- 5 **LEVEL**  
This control sets the signal level sent to the main mix.
- 6 **CLIP**  
When this LED turns or blinks red, it is an indication that the signal coming into the channel is too strong, potentially causing distortion. Turn down the Level control (5) until the Clip light is no longer present. If you are having difficulty getting a clean signal, try varying the output of the connected device.
- 7 **SIG**  
When this LED is green, it is an indication the mixer is receiving signal at the input of the channel. If you are having trouble getting sound out of the mixer and this LED is not on, check the microphone, instrument or cable that is connected to the channel.
- 8 **MIC/LINE INPUT**  
This combination input jack can accept either a 1/4" (balanced or unbalanced) input or an XLR balanced, low-impedance connection. The tip is positive on the 1/4" balanced input, and pin 2 is positive on the XLR.
- 8b **MIC/HI Z INPUT**  
Channel 5 line input is a Hi-Z unbalanced input for use with high impedance microphones, acoustic/electric guitars or other high impedance sources equipped with a 1/4" plug (TS).



9 **XLR BALANCED INPUT**

Channel 6 is designed specifically for pre-recorded (program) music, but can also be used with a microphone. This XLR input provides a balanced low impedance connection.

10 **MIC OR MEDIA SELECT BUTTON**

This control selects between the low impedance XLR (9) and the RCA / 1/8", or USB MP3/Bluetooth® input .

11a/11b. **MEDIA INPUT**

These RCA and 1/8" inputs accept a stereo input from the output of an MP3 player, CD player, tape deck or other similar device.

12 **FLS®**

When feedback occurs, the LED of the frequency closest to the frequency that is feeding back will illuminate over the slider to be adjusted. Slowly bring the corresponding slider down until feedback is gone. The LED will remain illuminated for a few seconds after the feedback is gone.

13 **GRAPHIC EQ**

These 9-band EQs are designed for 12dB cut or boost. These EQs are used to make minor adjustments to the overall mix and should be used sparingly.

14 **AMP LEVEL LED LADDER**

These LEDs indicate the signal level going to the power amplifier. The top LED indicates LIMIT and activation of our revolutionary DDT™ speaker protection circuit. Peavey's award winning speaker protection circuit is built into the PV®6500MP3 and activated automatically to maximize the power amplifier without fear of distortion.

**POWER AMP INPUT SELECT**

15 This control allows the user to select whether the 2nd power amplifier receives its signal from the Master Volume (17) control or from the Monitor Volume (16) control. This allows the user to run both power amps for mains at the same level, or use power amp 1 for mains and power amp 2 for monitors with independent level controls.

**MONITOR VOLUME**

16 An independent volume control that is active only when switch 15 is placed in the LEFT position. This allows the user independent volume control over the two internal power amplifiers. This is especially convenient when using power amp 2 to drive monitor speakers.

**MASTER VOLUME**

17 The master level control for the main mix and the overall volume of the powered mixer. When switch 15 is in the RIGHT position, the master volume controls both internal power amplifiers.

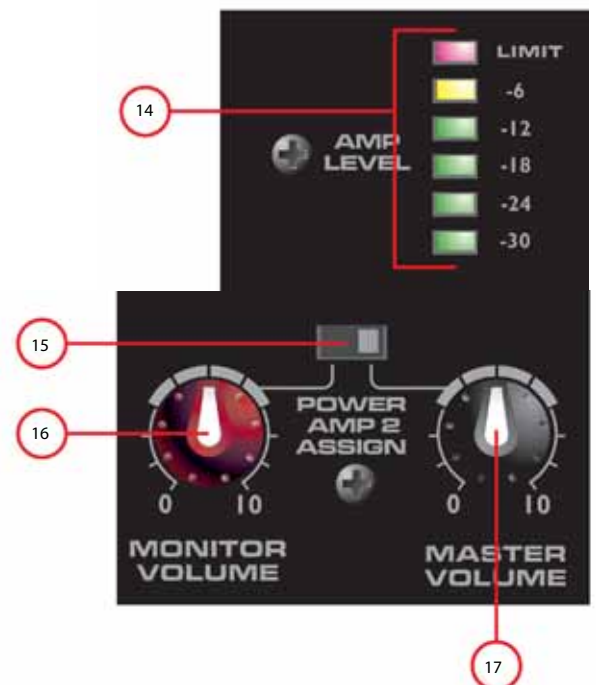
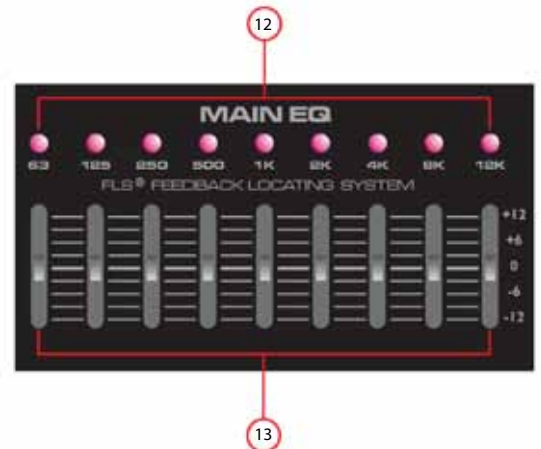
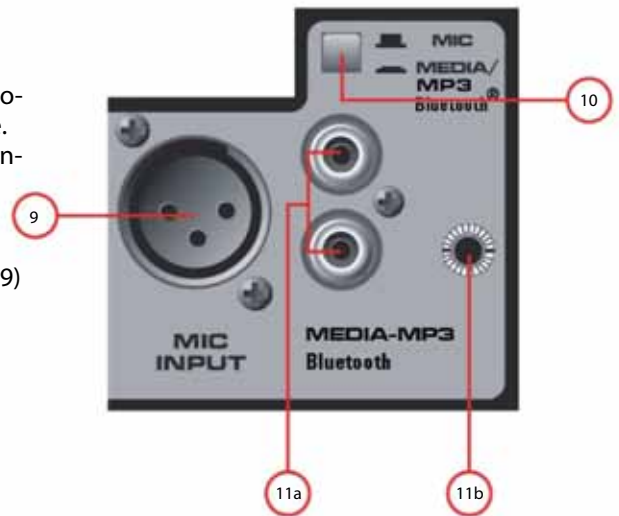

18 **MASTER MUTE LED**  
When the LED is ON it indicates the master mute is activated.

19 **MASTER MUTE**  
Depressing this button mutes channels one through five, preventing signal from passing to the power amplifier. This button does not affect channel 6.

20 **KOSMOS®-C**  
The Kosmos -C module uses special circuitry to enrich the sound of your system. The LOW control is not just a simple bass boost. It provides 'natural bass enhancement' by adding harmonically related bass signals that track envelope of the original signal. The Kosmos-C HIGH control can be used to add clarity to dull signals.

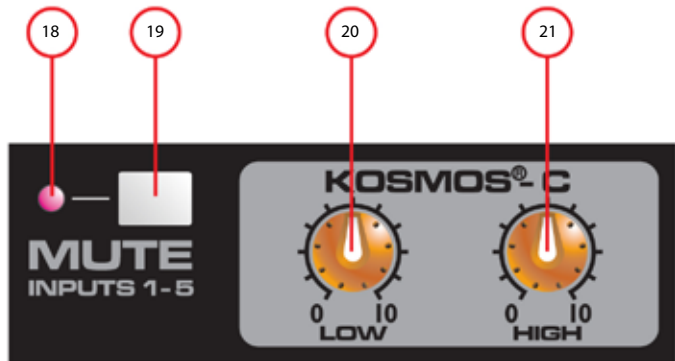

22 **EFFECTS TYPE TABLE**  
This table lists the types of effects available and the abbreviation used for each effect in the first character of the LED display. The chart also lists the parameter associated with each effect, which is controlled by turning encoder 24. A more detailed list of effects can be found at the end of this manual.



23 **EFX LED**  
This LED indicates the type of effect currently selected. When turning encoder 27 the display will flash until the encoder is depressed, selecting a new effect.

24 **PARAMETER CONTROL**  
This encoder controls the parameter associated with the selected effect, listed both on the mixer (22) and in this manual. The parameter control is used to make adjustments to the sound of the effect.

25 **EFX MUTE**  
When pushed this button bypasses the effects section, letting the user listen to the dry signal. When depressed and muted, LED 23 displays two dashes "--".

26 **CLIP LED**  
This LED blinks RED when the signal to the effects section is too hot and is causing distortion. Find the source of the hot signal by reducing the EFX SEND (4) on each channel until the LED is no longer clipping (blinking red).

27 **EFFECTS SELECT**  
Turn and push this encoder to select the desired effect.

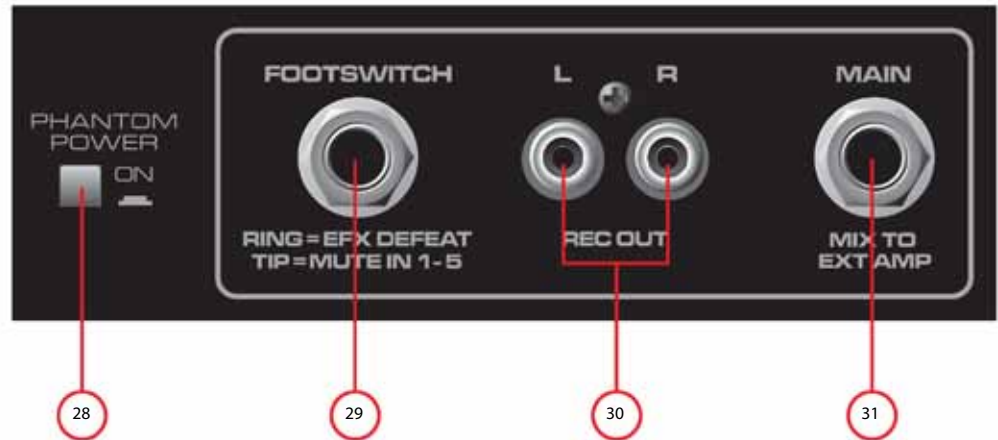

28 **PHANTOM POWER**

When depressed, this switch applies +15 VDC to all input XLR connectors to power microphones that require phantom power.

**Caution:** When phantom power is switched on, make sure that any channel you are plugging a microphone into is turned down and the Master Main and Monitor controls are set to minimum. Otherwise, there will be a loud pop in the system. For best results, first plug all microphones into their respective channels before phantom power is switched on. This reduces noise through the system and reduces the chance of damage to the microphones. If phantom power is used, do not connect unbalanced, dynamic microphones or other devices to the XLR inputs that cannot handle this voltage. (Some wireless receivers may be damaged. Consult their manuals.) The line input jacks are not connected to the phantom supply and are safe for all inputs (balanced or unbalanced). An unbalanced to balanced impedance converter such as the Peavey 5116 or a Peavey 1:1 Interface Adapter may also be used to isolate a microphone from phantom voltage.

29 **FOOTSWITCH**

This 1/4" TRS (tip ring sleeve) jack accepts a momentary 1/4" TRS dual button footswitch (Peavey part number 03014070) designed to defeat the effects on all channels and activate the MASTER MUTE switch (19).

30 **RCA RECORD OUT**

This pair of RCA jacks provides a signal to the recording inputs of a CD recorder, stereo tape deck, or other recording device.

**NOTE:** Do not connect a single device to the Media In (11a/11b) and Record Out (30). This improper setup forms a loop, which can cause severe feedback. Use separate devices for recording and playback.

31 **MAIN OUT**

This 1/4" jack provides a signal from the main mix (after the graphic EQ) for an external power amplifier. An external power amp, such as our IPR series of amplifiers, can then drive additional speakers.



## USB/SD MP3 Player



### 32 SD CARD SLOT

To connect the SD card, push the card completely in the slot until it clicks into place. The player will accept a SD card up to 32Gb in size.

### 33 USB disk SLOT

On the right side of the device is a USB drive slot where a USB memory stick can be connected. The player will accept a memory stick up to 32Gb.

### 34 MODE

If both, a memory stick and SD card are present, a short press of the MODE button will change between the USB input and the SD card input. A long press of the MODE button will shut off the MP3 player. Another long press is needed to turn it back on.

### 35 PLAY/PAUSE

A short press of the PLAY/PAUSE button causes the operation to change from PLAY to PAUSE or from PAUSE back to PLAY. A long press of the PLAY/PAUSE button will put the player into navigation mode. When in navigation mode the player can toggle between multiple folders on the memory device. The file folder num is displayed at the top of the screen while the file folder name is at the bottom. The "track skip (38)" buttons can be used to toggle between the folders on the memory device. Once the desired folder is found, press "PLAY/PAUSE" to select the folder. The first song in the folder will begin playing.

### 36 STOP

Press the STOP button to stop a file that is playing.

### 37 REPEAT

Pressing the REPEAT button toggles the function between ALL, RANDOM and SINGLE.

ALL: Repeats all songs.

RANDOM: Plays songs in random order.

SINGLE: Repeats a single song.

Note: The REPEAT functions only apply to the songs in the selected folder.

### 38 TRACK SKIP

In playback mode the TRACK SKIP buttons let you select the track to play.

A short press skips to the next track. A long press allows you to fast forward/rewind through a song. Hold the button down until the desired playback point is found. Release the button and the song will start playing.

In navigation mode, the TRACK SKIP buttons are used to increment/decrement through the folders on the memory device.

39

### Bluetooth® Switch

Turns the Bluetooth on and off. Slide the switch to the right to turn the Bluetooth feature on.

40

### Bluetooth® indicator LED

Indicates the status of the Bluetooth function.

To listen to your music via Bluetooth wireless connection, you need to pair (link) your PV®i 6500 with your Bluetooth phone and/or music device.

1. Turn off any Bluetooth devices previously paired with your PV®i 6500.
2. Turn on the Bluetooth feature on your phone or music device.
3. Slide the switch (39) to the right to turn on the Bluetooth feature. The Bluetooth LED will flash to indicate your PV®i 6500 is in discoverable mode.
4. Place your phone or music device in Bluetooth search mode.

The phone or music device will now begin searching for your PV®i 6500.

5. Select **Bluetooth audio** from search results on your phone or music device.
6. Select OK or Yes to pair your speaker system with your phone or music device.

When your PV®i 6500 successfully pairs and connects with your phone or music device, the Bluetooth indicator changes from flashing green to steadily lit. You will now be able to play music from your connected music source through your PV®i 6500. The level can either be adjusted from the connected source or by the level control in Channel 6.

\* Wireless range can vary depending on Bluetooth class of source device, and be subject to interference from obstructions such as walls or other electronic devices.

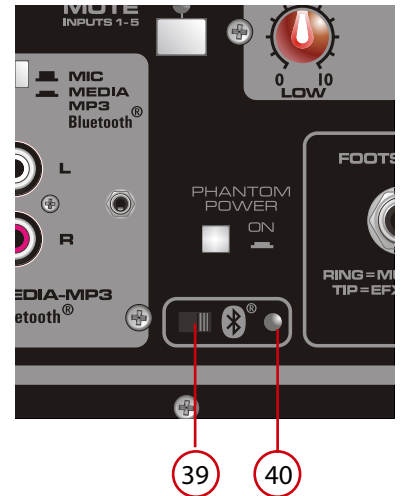

41

## POWER SWITCH

This is the main power switch.

42

## FUSE

This is the main safety fuse for the AC line voltage. Only replace with a fuse of the exact type and rating. If the fuse continues to open, do not over fuse. Take the unit to an authorized Peavey service center.

**NOTE: If the main AC voltage is changed, the fuse must also be changed to one of the appropriate rating for the voltage you are switching to.**

43

## AC POWER INLET

This is the receptacle for an IEC line cord, which provides AC power to the unit. Connect the line cord to this connector to provide power to the unit. Damage to the equipment may result if improper line voltage is used. (See line voltage marking on unit).

Never break off the ground pin on any equipment. It is provided for your safety. If the outlet used does not have a ground pin, a suitable grounding adapter should be used and the third wire should be grounded properly. To prevent risk of shock or fire hazard, always make sure that the amplifier and all associated equipment is properly grounded.

## NOTE: FOR UK ONLY

As the colors of the wires in the mains lead of this apparatus may not correspond directly with the colored markings identifying the terminals in your plug, proceed as follows: (1) The green and yellow wire must be connected to the terminal which is marked with the letter E, or by the earth symbol, or is colored green, or green and yellow. (2) The blue wire must be connected to the terminal which is marked with the letter N, or the color black. (3) The brown wire must be connected to the terminal which is marked with the letter L, or the color red.

44

## VOLTAGE SELECTOR SWITCH

This switch allows the user to select between 115VAC / 60Hz or 230VAC / 50Hz. To change the voltage selector, you must first unscrew and remove the plastic cover that protects the switch. After changing the voltage, please replace the plastic cover to ensure the voltage level is not inadvertently altered.

**NOTE: The fuse MUST be changed to the appropriate value to match the voltage you have selected. Please see the note on the back of the mixer for the correct value.**

45

## MAIN / MONITOR SPEAKER OUTPUTS

46

These are two-conductor 1/4" speaker outputs. Each one is rated at 4 ohms minimum impedance. You may connect either one 4-ohm, one 8-ohm or two 8-ohm speakers to each output. Do not operate below rated minimum impedance. For maximum power transfer, be sure to use speaker cables and not instrument cables to connect to the speakers. We recommend the use of 18-gauge or larger speaker wire.

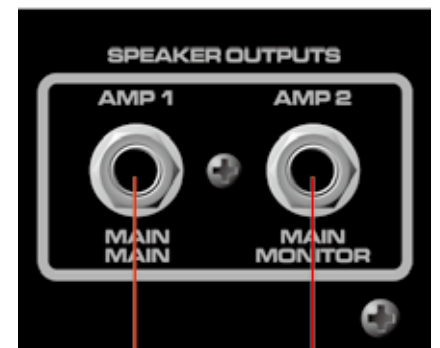
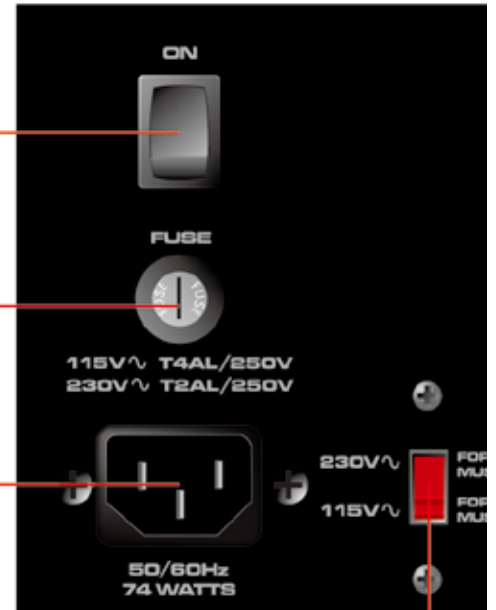

## Effects (parameter)

PLATE (TIME)	DESCRIPTION	PREDELAY DAMP FACTOR	ROOM	ROOM SIZE	FRONT END HP	BACK END LP	MORE DESCRIPTIVE NAME
P1	Bright	35 ms					
P2	Gentle LP	48 ms					
P3	Med LP	62 ms					
P4	Hard LP	78 ms					
P5	Dark	95 ms					

### HALL (TIME)

H1	Vox Fox	35 ms	Med	Med	Subtle	Subtle	Med Hall
H2	Vox Huge	42 ms	Med	Large	Subtle	Subtle	Cathedral
H3	Vox Glow	10 ms	Med	Large	Subtle	Subtle	Auditorium
H4	Strings	30 ms	Med	Med	Subtle	Subtle	Concert Hall
H5	Brass Hall	35 ms	High	Med	Subtle	Moderate	Concert Hall 2

### ROOM (TIME)

R1	Vox Air	30 ms	Low	Small	Aggressive	Subtle	Hard Walls
R2	Vox Club	35 ms	High	Small	Subtle	Moderate	Club
R3	Snare Low	70 ms	Low	Small	Moderate	Subtle	Bathroom
R4	AC GTR	42 ms	Med	Small	Moderate	Subtle	Med Walls
R5	Brass Room	40 ms	High	Med	Subtle	Moderate	Med Room Damped Walls

### DELAY (TIME)

D1	Double
D2	Slapback
D3	Bright, Few Repeats
D4	Bright, More Repeats
D5	Bright, Most Repeats
D6	Dark, Few Repeats
D7	Dark, More Repeats
D8	Dark, Most Repeats

### ENHANCE (CUTOFF FREQ)

E1	Light Harmonics
E2	Moderate Harmonics
E3	Heavy Harmonics

### CHORUS (RATE)

CHORUS (RATE)		PREDELAY	CHORUS TIME	RATE	MODULATION
C1	High Depth, Slow Rate	10 ms	20 ms	0.1 - 1 Hz	Random Sine
C2	Mod Depth, Wide Rate	10 ms	5 ms	0.5 - 4 Hz	Random Sine
C3	Short Depth, Wide Rate	10 ms	2 ms	0.5 - 6 Hz	Sine
C4	Short Depth, Fast Rate	5 ms	1 ms	5 - 15 Hz	Random Sine
C5	High Depth, Mod Rate	2 ms	20 ms	0.2 - 3 Hz	Random Sine

# Block Diagram

## CHANNEL 1 - 4

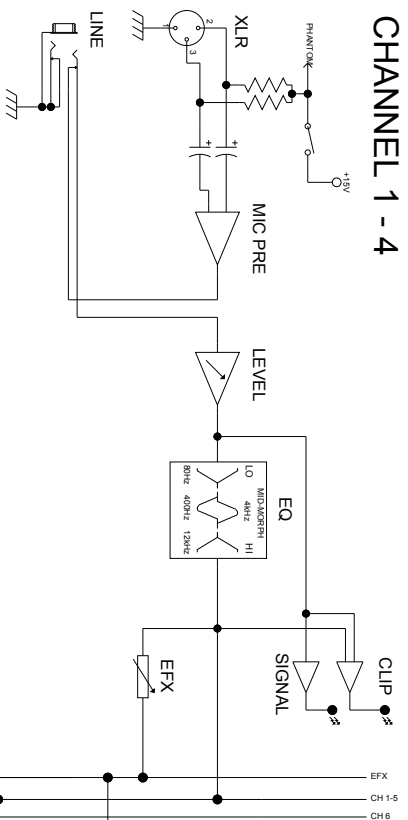

## CHANNEL 5 HI-Z

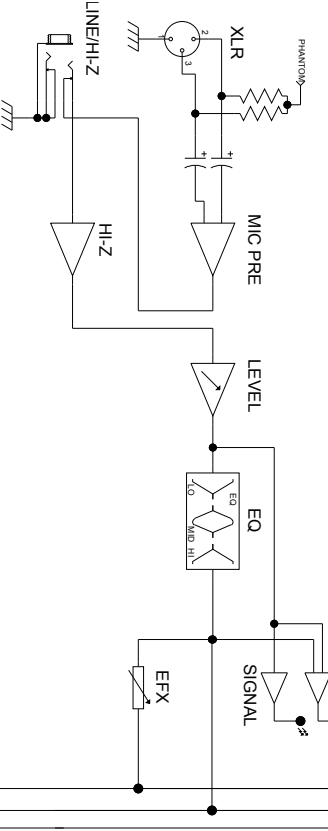

## CHANNEL 6

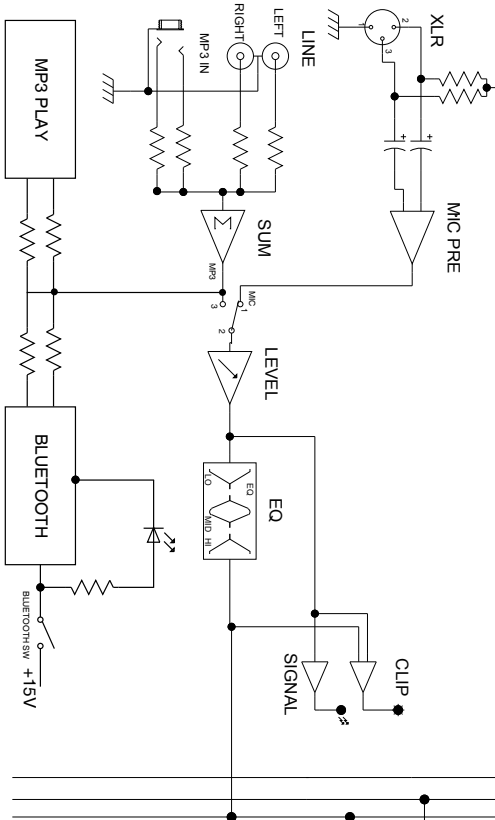

## PV6500MP3 BLOCK DIAGRAM

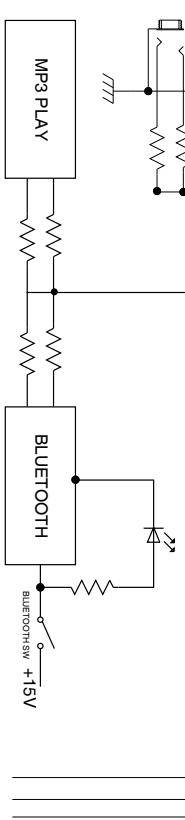
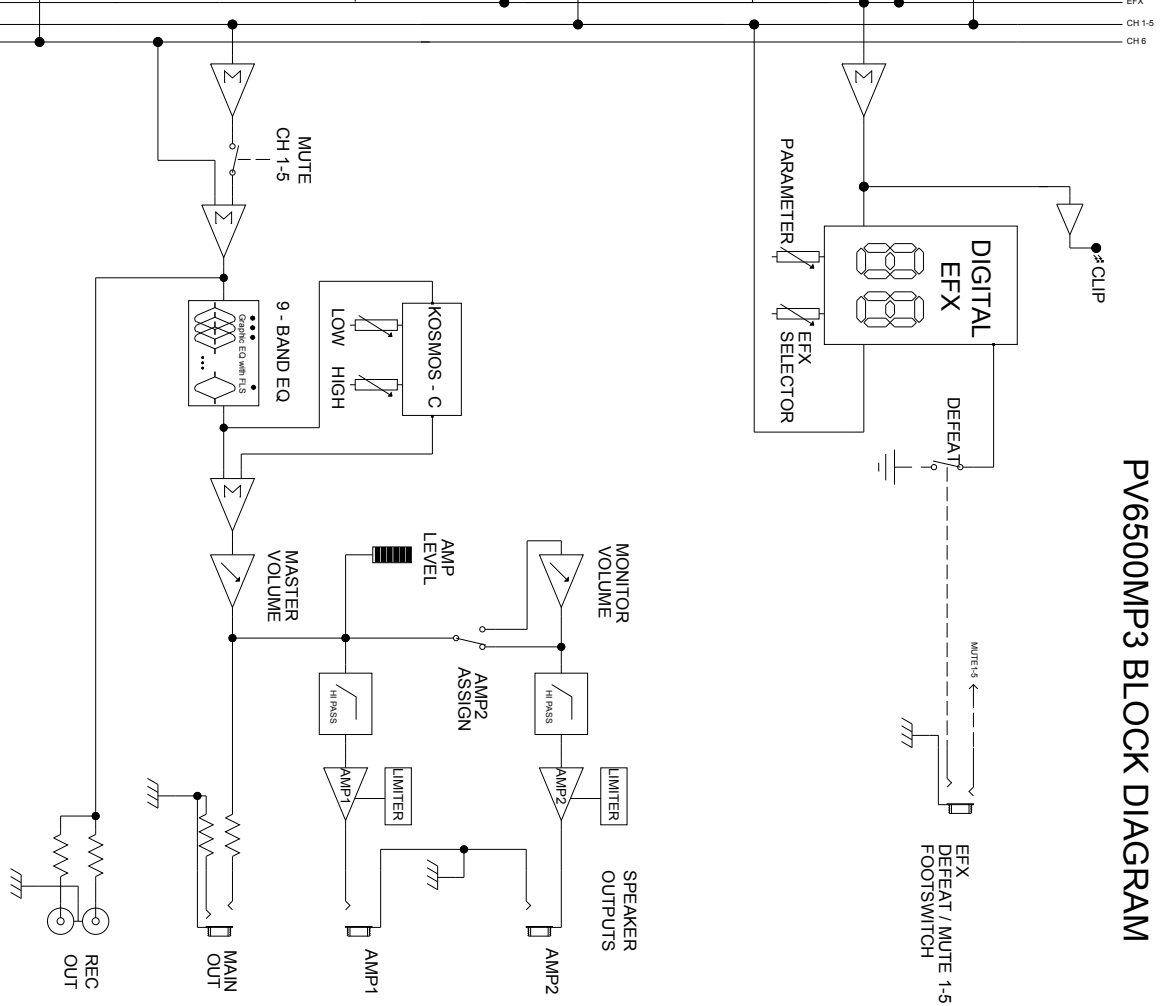

# Specifications

## INPUT SENSITIVITY:

Mic In to full power at the power amp. Master Volume Nom.

Full                      Nominal  
-40 dBu                -22 dBu

Line In to full power at the power amp. Master Volume Nom.

Full                      Nominal  
-10 dBu                +8 dBu

## CHANNEL EQ:

Shelving EQ

Low EQ	80 Hz	±15 dB
Mid-Morph		
Low	250 Hz	±15 dB
High	4 kHz	±15 dB
High EQ	12 kHz	±15 dB

## CLIP LED:

Clip LEDs come on 3 dB before clipping.

## FREQUENCY RESPONSE:

All controls nominal (detent)

Mic to Main	20 Hz – 20 kHz	+0, -1 dB
Line to Main	20 Hz – 30 kHz	+0, -1 dB
Mic to Amp	50 Hz – 20 kHz	+0, -3 dB
Line to Amp	40 Hz – 20 kHz	+0, -3 dB

## PHANTOM POWER:

+15 VOLTS

## NOISE:

Main = Main line output, 22 – 22 kHz filter

Amp 1 = Amplifier output, loaded at 4 Ohms, through AP

AUX-0025 switching amplifier filter

All controls full down.

Main	<-95 dBu
Amp 1	<-70 dBu
Master Volume nominal	
Main	<-88 dBu
Amp 1	<-67 dBu

## THD:

All controls nominal

<0.01% @ main line output, -30 dBu in mic input Channel 1

<0.5% @ amp 1 @ 100 Watts into 4 Ohms

All controls nominal

<0.005% @ main line output, +4 dBu in line input Channel 1

<0.05% @ amp 1 @ 100 Watts into 4 Ohms

## MASTER EQ:

63Hz	±12 dB
125Hz	±12 dB
250Hz	±12 dB
500Hz	±12 dB
1kHz	±12 dB
2kHz	±12 dB
4kHz	±12 dB
8kHz	±12 dB
12kHz	±12 dB

## METER ARRAY:

LIMIT

-6 dB                      -12 dB                      -18 dB                      -24 dB                      -30 dB

## AMP LIMITER:

Limits amplifier power just before clipping. The limiter holds the amp power without clipping and can be driven up to 18 dB past maximum output.

## AMPLIFIER OUTPUT POWER:

120VAC

Both channels loaded at 8 ohms:	60 Watts RMS per ch 120 Watts Peak per ch
Both channels loaded at 4 ohms:	100 Watts RMS per ch 200 Watts Peak per ch

## POWER REQUIREMENTS:

Domestic:	120VAC 50/60Hz	74 Watts Nominal
Export:	230VAC 50/60Hz	74 Watts Nominal

## SIZE:

Dimensions:                      H x W x D  
10.25" x 16.5" x 10.75"

## WEIGHT:

20.4 lbs.

## MP3 PLAYER:

Memory Device  
SD Card - Up to 32Gb SDHC card.  
Jump Drive - Up to 32Gb memory device.

## File format

Format	File Type	Sample Rate	Bit Rate
MPEG 1/2/2.5 Layer 3	MP3	All*	32kbps-320kbps CBR/VBR
WMA	WMA, ASF	All*	32kbps-320kbps
PCM	WAV	All*	N/A

\*Sample Rates: 8k/11.025k/12k/16k/22.05k/24k/32k/44.1k and 48k

## BLUETOOTH® PLAYER:

Fully Bluetooth 3.0 + EDR system in 2.4 GHz ISM band.

- Built-in internal ROM for program memory
- Built-in 32 KB RAM for data storage and baseband data transfer buffering
- Enhanced Power Control
- High speed HCI-UART (Universal Asynchronous Receiver Transmitter) interface ·Max. +4dBm output power with 20 dB level control from register control.

Take your music with you with the extended wireless range of up to 10m/33ft.

SUBPART J OF FCC RULES. THIS DEVICE COMPLIES WITH PART 15 OF THE FCC RULES. OPERATION IS SUBJECT TO THE FOLLOWING TWO CONDITIONS (1) THIS DEVICE MAY NOT CAUSE HARMFUL INTERFERENCE, AND (2) THIS DEVICE MUST ACCEPT ANY INTERFERENCE RECEIVED, INCLUDING INTERFERENCE THAT MAY CAUSE UNDESIRABLE OPERATION.



Features and specifications subject to change without notice.

Peavey Electronics Corporation • 5022 Hartley Peavey Drive • Meridian, MS • 39305  
(601) 483-5365 • FAX (601) 486-1278 • www.peavey.com • EX000138 • ©2013

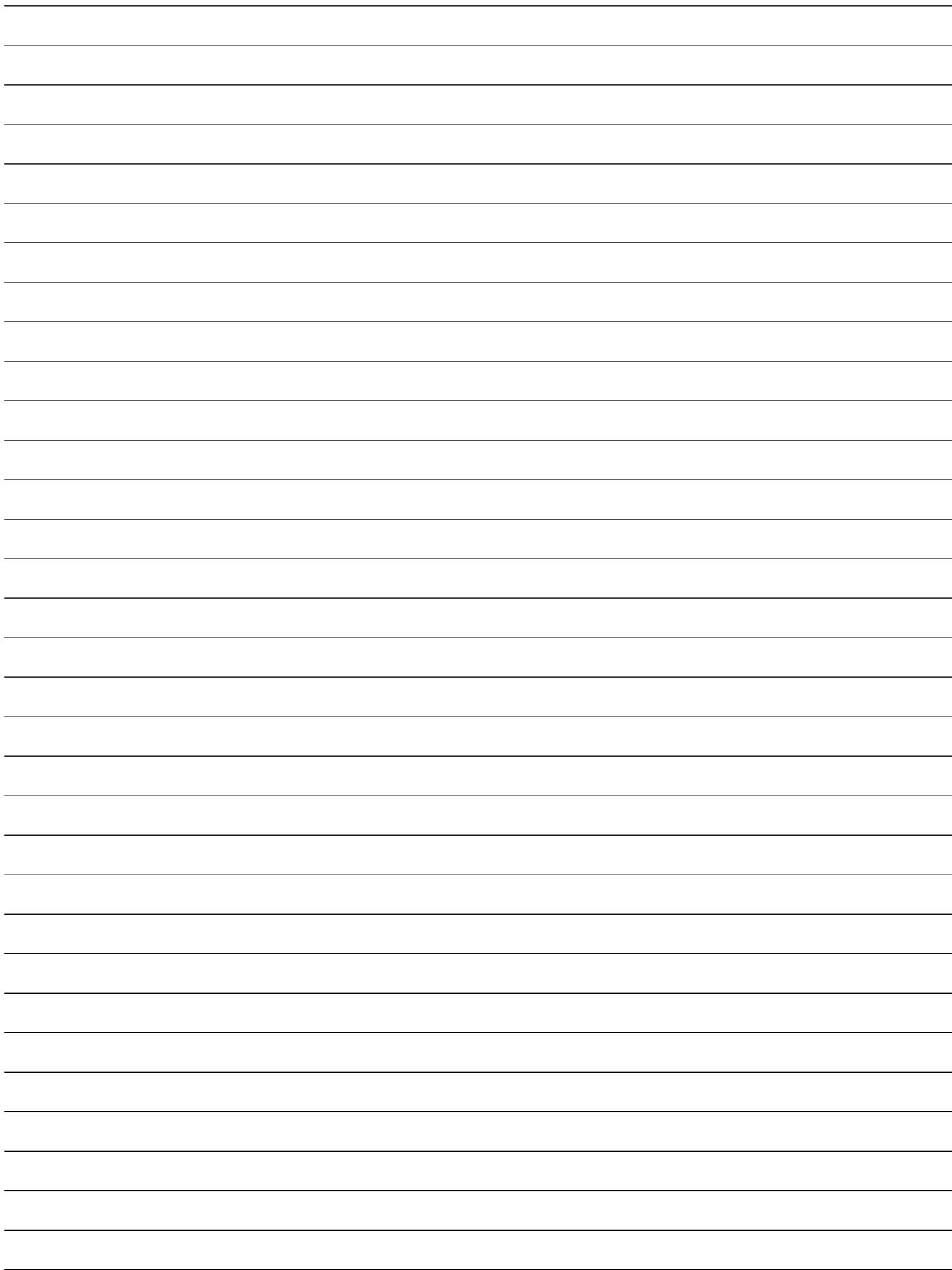

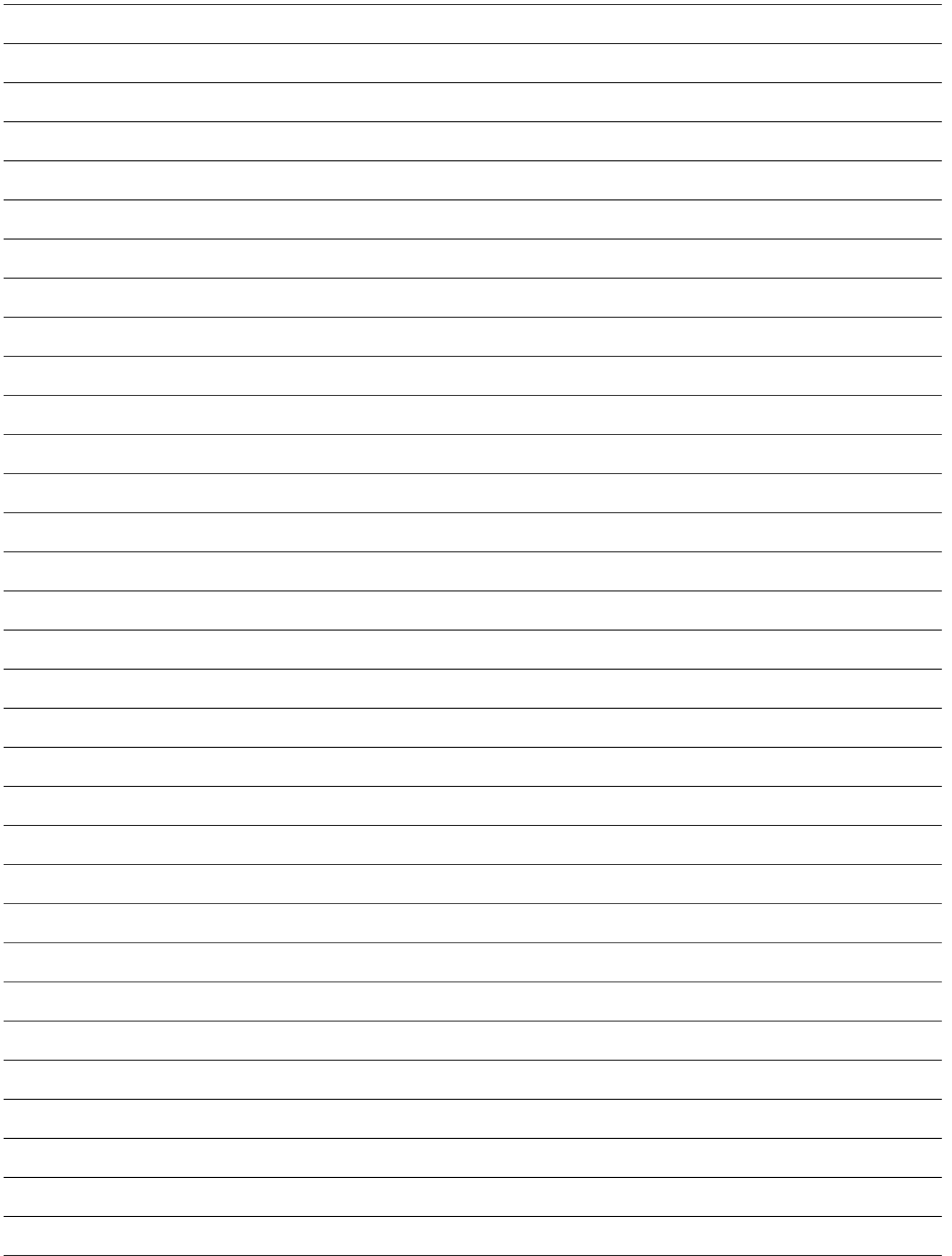



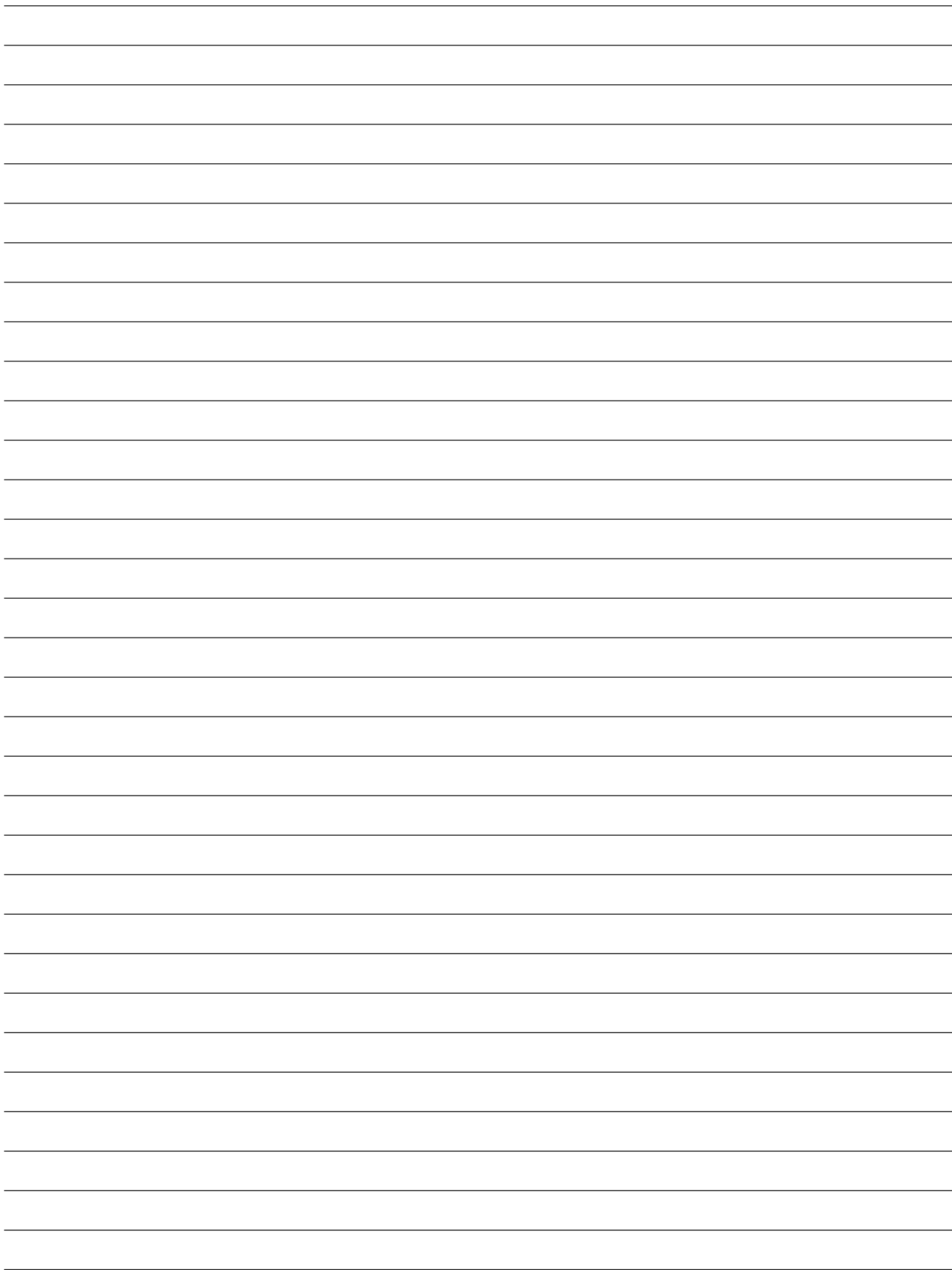

# PEAVEY ELECTRONICS CORPORATION LIMITED WARRANTY

Effective Date: 03/04/2010

## What This Warranty Covers

Your Peavey Warranty covers defects in material and workmanship in Peavey products purchased and serviced in the U.S.A. and Canada.

## What This Warranty Does Not Cover

The Warranty does not cover: (1) damage caused by accident, misuse, abuse, improper installation or operation, rental, product modification or neglect; (2) damage occurring during shipment; (3) damage caused by repair or service performed by persons not authorized by Peavey; (4) products on which the serial number has been altered, defaced or removed; (5) products not purchased from an Authorized Peavey Dealer.

## Who This Warranty Protects

This Warranty protects only the original purchaser of the product.

## How Long This Warranty Lasts

The Warranty begins on the date of purchase by the original retail purchaser. The duration of the Warranty is as follows:

Product Category	Duration
Guitars/Basses, Amplifiers, Preamplifiers, Mixers, Electronic Crossovers and Equalizers	2 years *(+ 3 years)
Drums	2 years *(+ 1 year)
Enclosures	3 years *(+ 2 years)
Digital Effect Devices and Keyboards and MIDI Controllers	1 years *(+ 1 year)
Microphones	2 years
Speaker Components (incl. Speakers, Baskets, Drivers, Diaphragm Replacement Kits and Passive Crossovers)	1 year
Tubes and Meters	90 Days
Cables	Limited Lifetime
Rockmaster Series, Strum'n Fun, Vectra, Rotor, OCC Stage pack, GT & BT Series amps, Retro Fire, Metal Maker and Iron Wing	1 year

[\* Denotes additional Warranty period applicable if optional Warranty Registration Card is completed and returned to Peavey by original retail purchaser within 90 days of purchase.]

## What Peavey Will Do

We will repair or replace (at Peavey's discretion) products covered by Warranty at no charge for labor or materials. If the product or component must be shipped to Peavey for Warranty service, the consumer must pay initial shipping charges. If the repairs are covered by Warranty, Peavey will pay the return shipping charges.

## How To Get Warranty Service

(1) Take the defective item and your sales receipt or other proof of date of purchase to your Authorized Peavey Dealer or Authorized Peavey Service Center.

OR

(2) Ship the defective item, prepaid, to Peavey Electronics Corporation, International Service Center, 412 Highway 11 & 80 East, Meridian, MS 39301. Include a detailed description of the problem, together with a copy of your sales receipt or other proof of date of purchase as evidence of Warranty coverage. Also provide a complete return address.

## Limitation of Implied Warranties

ANY IMPLIED WARRANTIES, INCLUDING WARRANTIES OF MERCHANTABILITY AND FITNESS FOR A PARTICULAR PURPOSE, ARE LIMITED IN DURATION TO THE LENGTH OF THIS WARRANTY.

Some states do not allow limitations on how long an implied Warranty lasts, so the above limitation may not apply to you.

## Exclusions of Damages

PEAVEY'S LIABILITY FOR ANY DEFECTIVE PRODUCT IS LIMITED TO THE REPAIR OR REPLACEMENT OF THE PRODUCT, AT PEAVEY'S OPTION. IF WE ELECT TO REPLACE THE PRODUCT, THE REPLACEMENT MAY BE A RECONDITIONED UNIT. PEAVEY SHALL NOT BE LIABLE FOR DAMAGES BASED ON INCONVENIENCE, LOSS OF USE, LOST PROFITS, LOST SAVINGS, DAMAGE TO ANY OTHER EQUIPMENT OR OTHER ITEMS AT THE SITE OF USE, OR ANY OTHER DAMAGES WHETHER INCIDENTAL, CONSEQUENTIAL OR OTHERWISE, EVEN IF PEAVEY HAS BEEN ADVISED OF THE POSSIBILITY OF SUCH DAMAGES.

Some states do not allow the exclusion or limitation of incidental or consequential damages, so the above limitation may not apply to you.

This Warranty gives you specific legal rights, and you may also have other rights which vary from state to state.

If you have any questions about this Warranty or services received or if you need assistance in locating an Authorized Service Center, please contact the Peavey International Service Center at (601) 483-5365.

Features and specifications are subject to change without notice.



Logo referenced in Directive 2002/96/EC Annex IV (OJ(L)37/38, 13.02.03 and defined in EN 50419: 2005  
The bar is the symbol for marking of new waste and is applied only to equipment manufactured after 13 August 2005

# Optional Product Extended Warranty Registration

Give us some information and put your extended warranty into effect!

Please take a few minutes to fill out this information/survey sheet to help us get to know and serve you better.  
**To save time, submit your warranty registration online at [www.peavey.com/support/warrantyregistration](http://www.peavey.com/support/warrantyregistration)**

**1.**

First Name \_\_\_\_\_ Initial \_\_\_\_\_ Last Name \_\_\_\_\_

Street Address \_\_\_\_\_  
 \_\_\_\_\_

City \_\_\_\_\_ State/Province \_\_\_\_\_ Postal Code \_\_\_\_\_

( ) \_\_\_\_\_  
 Telephone Number \_\_\_\_\_ E-mail Address \_\_\_\_\_

( ) \_\_\_\_\_ - -  
 Fax Number \_\_\_\_\_ Date of birth \_\_\_\_\_

Gender  M  F

**2.**

Model \_\_\_\_\_ Serial # \_\_\_\_\_

Date of Purchase \_\_\_\_\_ Price Paid \_\_\_\_\_

**3.**

Name of store where purchased \_\_\_\_\_

City \_\_\_\_\_ State \_\_\_\_\_

**4. Top two (2) reasons why you purchased from this store/dealer:**

- |   |  |
|---|--|
| <input type="checkbox"/> Availability of product          | <input type="checkbox"/> Past favorable experience |
| <input type="checkbox"/> Friend/Relative's recommendation | <input type="checkbox"/> Best price                |
| <input type="checkbox"/> Store credit card                | <input type="checkbox"/> Advertised special        |
| <input type="checkbox"/> Knowledgeable staff              | <input type="checkbox"/> Convenient location       |
| <input type="checkbox"/> Availability of lessons          | <input type="checkbox"/> Received as a gift        |
| <input type="checkbox"/> Technical instruction            | <input type="checkbox"/> Other _____               |

**5. Where do you most often shop for music and sound products?**

- |   |   |
|---|---|
| <input type="checkbox"/> Independent retailer | <input type="checkbox"/> Newspaper ads      |
| <input type="checkbox"/> Mass market retailer | <input type="checkbox"/> Internet/Web sites |
| <input type="checkbox"/> Mail order magazines | <input type="checkbox"/> Other _____        |

**6. What two (2) factors most influenced your purchase of this product?**

- |  |   |
|--|---|
| <input type="checkbox"/> Peavey brand name   | <input type="checkbox"/> Product appearance           |
| <input type="checkbox"/> Craftsmanship       | <input type="checkbox"/> Durability                   |
| <input type="checkbox"/> Features for price  | <input type="checkbox"/> Prior experience with Peavey |
| <input type="checkbox"/> Bundled accessories | <input type="checkbox"/> Packaging                    |
| <input type="checkbox"/> Sound quality       | <input type="checkbox"/> Other _____                  |

**15. In your opinion, what could Peavey do to improve its products and/or service? Please use the space below to tell us your answer.**

\_\_\_\_\_  
 \_\_\_\_\_  
 \_\_\_\_\_

**7. How did you learn about this Peavey product? (select best answer)**

- |   |   |
|---|---|
| <input type="checkbox"/> Magazine review                  | <input type="checkbox"/> Teacher's recommendation |
| <input type="checkbox"/> Newspaper review                 | <input type="checkbox"/> Catalog or flyer         |
| <input type="checkbox"/> Radio advertisement              | <input type="checkbox"/> Saw in store             |
| <input type="checkbox"/> Advertised special               | <input type="checkbox"/> Use by professional      |
| <input type="checkbox"/> Friend/Relative's recommendation | <input type="checkbox"/> Other _____              |
| <input type="checkbox"/> Salesperson's recommendation     |   |

**8. Which other brands/models did you consider?**

\_\_\_\_\_  
 \_\_\_\_\_

**9. How would you describe your level of musicianship/technical expertise?**

- Beginner - Never played or taken less than one (1) year of lessons  
 Intermediate - One (1) to five (5) years of lessons or playing  
 Advanced - More than five (5) years of lessons or playing; play professionally

**10. Education: (select best answer)**

- High school  
 Some college  
 Completed college  
 Graduate school

**11. Which best describe your family income? (select best answer)**

- |  |  |
|--|--|
| <input type="checkbox"/> Under \$15,000      | <input type="checkbox"/> \$75,000 - \$99,999   |
| <input type="checkbox"/> \$15,000 - \$24,999 | <input type="checkbox"/> \$100,000 - \$149,999 |
| <input type="checkbox"/> \$25,000 - \$34,999 | <input type="checkbox"/> Over - \$150,000      |
| <input type="checkbox"/> \$35,000 - \$49,999 |  |
| <input type="checkbox"/> \$50,000 - \$74,999 |  |

**12. Which of the following is your primary source of information on musical products: (select best answer)**

- |                                     |   |
|-------------------------------------|---|
| <input type="checkbox"/> Television | <input type="checkbox"/> Mail order catalogs          |
| <input type="checkbox"/> Radio      | <input type="checkbox"/> Direct mail                  |
| <input type="checkbox"/> Internet   | <input type="checkbox"/> Literature from manufacturer |
| <input type="checkbox"/> Newspaper  | <input type="checkbox"/> Other _____                  |
| <input type="checkbox"/> Magazines  |   |

**13. What is your main motivation for buying new equipment?**

- |  |  |
|--|--|
| <input type="checkbox"/> Replacing old product               | <input type="checkbox"/> Impulse                       |
| <input type="checkbox"/> Want new and leading edge equipment | <input type="checkbox"/> Need for improved performance |
| <input type="checkbox"/> Fulfill a specific need             | <input type="checkbox"/> New technology                |
| <input type="checkbox"/> Supplement existing products        | <input type="checkbox"/> Availability of product       |
| <input type="checkbox"/> Value                               | <input type="checkbox"/> Other _____                   |

**14. Please list your three most frequently visited Web sites.**

1. http:// \_\_\_\_\_  
 2. http:// \_\_\_\_\_  
 3. http:// \_\_\_\_\_



**FROM:**

Place  
Postage  
Here

**Peavey Electronics Corporation**  
Attn: Warranty Department  
P.O. Box 5108  
Meridian, Ms 39302-5108

