

ELMO

VISUAL PRESENTER

PX-30E / PX-10E

INSTRUCTION MANUAL



■ IMPORTANT SAFEGUARDS

- **Read Instructions**

All the safety and operating instructions should be read before the appliance is operated.
- **Retain Instructions**

The safety and operating instructions should be retained for future reference.
- **Heed Warnings**

All warnings on the product and in the operating instructions should be adhered to.
- **Follow Instructions**

All operating and use instructions should be followed.
- **Cleaning**

Unplug this product from the wall outlet before cleaning. Do not use liquid cleaners or aerosol cleaners. Use a damp cloth for cleaning.
- **Attachments**

Do not use attachments not recommended by the product manufacturer as they may cause hazards.
- **Water and Moisture**

Do not use this product near water - for example, near a bath tub, wash bowl, kitchen sink, or laundry tub, in a wet basement, or near a swimming pool, and the like.
- **Placement**

Do not place this product on an unstable cart, stand, tripod, bracket, or table. The product may fall, causing serious injury to a child or adult, and serious damage to the product. Use only with a cart, stand, tripod, bracket, or table recommended by the manufacturer, or sold with the product. Any mounting of the product should follow the manufacturer's instructions, and should use a mounting accessory recommended by the manufacturer.
- **Ventilation**

Slots and openings in the cabinet are provided for ventilation and to ensure reliable operation of the product and to protect it from overheating, and these openings must not be blocked or covered. The openings should never be blocked by placing the product on a bed, sofa, rug, or other similar surface. This product should not be placed in a built-in installation such as a bookcase or rack unless proper ventilation is provided or the manufacturer's instructions have been adhered to.
- **Power Sources**

This product should be operated only from the type of power source indicated on the marking label. If you are not sure of the type of power supply to your home consult your appliance dealer or local power company. For products intended to operate from battery power, or other sources, refer to the operating instructions.
- **Grounding or Polarization**

This product may be equipped with either a polarized 2-wire AC line plug (a plug having one blade wider than the other) or a 3-wire grounding type plug, a plug having a third (grounding) pin. If the 2-Wire polarized plug will not fit in the outlet, try reversing the plug. If the plug still fails to fit, contact your electrician to replace your obsolete outlet. Do not defeat the safety purpose of the polarized plug. The 3-wire grounding type plug will fit into a grounding type power outlet.
This is a safety feature. If you are unable to insert the plug into the outlet, contact your electrician to replace your obsolete outlet. Do not defeat the safety purpose of the grounding type plug.
- **Power-Cord Protection**

Power-supply cords should be routed so that they are not likely to be walked on or pinched by items placed upon or against them, paying particular attention to cords at plugs, convenience receptacles, and the point where they exit from the product.

■ Lightning

For added protection for this product during a lightning storm, or when it is left unattended and unused for long periods of time, unplug it from the wall outlet and disconnect the antenna or cable system. This will prevent damage to the product due to lightning and power-line surges.

■ Overloading

Do not overload wall outlets, extension cords, or integral convenience receptacles as this can result in a risk of fire or electric shock.

■ **A product and cart combination should be moved with care. Quick stops, excessive force, and uneven surfaces may cause the product and cart combination to overturn.**



■ Object and Liquid Entry

Never push objects of any kind into this product through openings as they may touch dangerous voltage points or short-out parts that could result in a fire or electric shock. Never spill liquid of any kind on the product.

■ Servicing

Do not attempt to service this product yourself as opening or removing covers may expose you to dangerous voltage or other hazards. Refer all servicing to qualified service personnel.

■ Damage Requiring Service

Unplug this product from the wall outlet and refer servicing to qualified service personnel under the following conditions:

- When the power-supply cord or plug is damaged.
- If liquid has been spilled, or objects have fallen into the product.
- If the product has been exposed to rain or water.
- If the product does not operate normally by following the operating instructions. Adjust only those controls that are covered by the operating instructions as an improper adjustment of other controls may result in damage and will often require extensive work by a qualified technician to restore the product to its normal operation.
- If the product has been dropped or damaged in any way.
- When the product exhibits a distinct change in performance - this indicates a need for service.

■ Replacement Parts

When replacement parts are required, be sure the service technician has used replacement parts specified by the manufacturer or have the same characteristics as the original part. Unauthorized substitutions may result in fire, electric shock or other hazards.

■ Safety Check

Upon completion of any service or repairs to this product, ask the service technician to perform safety checks to determine that the product is in proper operating condition.

■ Heat

The product should be situated away from heat sources such as radiators, heat registers, stoves, or other products (including amplifiers) that produce heat.

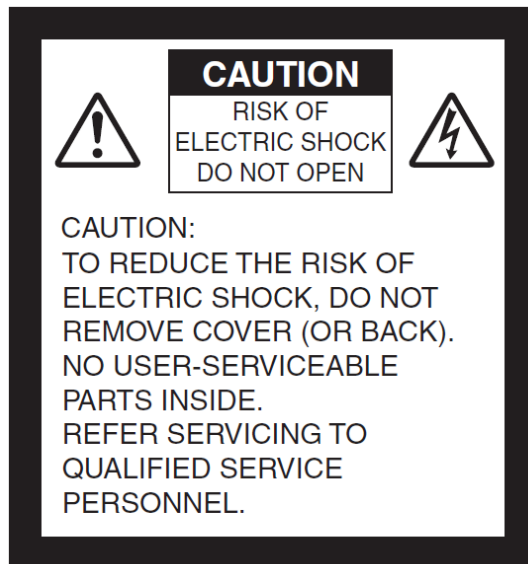

SA 1965

The lightning flash with arrowhead symbol, within an equilateral triangle, is intended to alert the user to the presence of uninsulated “dangerous voltage” within the product’s enclosure that may be of sufficient magnitude to constitute a risk of electric shock to persons.



SA 1966

The exclamation point within an equilateral triangle is intended to alert the user to the presence of important operating and maintenance (servicing) instructions in the literature accompanying the product.



This symbol [crossed-out wheeled bin WEEE Annex IV] indicates separate collection of waste electrical and electronic equipment in the EU countries.
Please do not throw the equipment into the domestic refuse.
Please use the return and collection systems available in your country for the disposal of this product.

WARNING

TO REDUCE THE RISK OF FIRE OR ELECTRIC SHOCK, DO NOT EXPOSE THIS PRODUCT TO RAIN OR MOISTURE.

The connection of a non-shielded equipment interface cable to this equipment will invalidate the FCC Certification or Declaration of this device and may cause interference levels which exceed the limits established by the FCC for this equipment. It is the responsibility of the user to obtain and use a shielded equipment interface cable with this device. If this equipment has more than one interface connector, do not leave cables connected to unused interfaces. Changes or modifications not expressly approved by the manufacturer could void the user's authority to operate the equipment.

**FOR UNITED STATES USERS:
INFORMATION**

This equipment has been tested and found to comply with the limits for a Class A digital device, pursuant to Part 15 of the FCC Rules. These limits are designed to provide reasonable protection against harmful interference when the equipment is operated in a commercial environment.

This equipment generates, uses, and can radiate radio frequency energy and, if not installed and used in accordance with the instruction manual, may cause harmful interference to radio communications. Operation of this equipment in a residential area is likely to cause harmful interference in which case the user will be required to correct the interference at his own expense.

USER-INSTALLER**CAUTION:**

Your authority to operate this FCC verified equipment could be voided if you make changes or modifications not expressly approved by the party responsible for compliance to Part 15 of the FCC rules.

BEFORE YOU USE

- The supplied power cord and AC adapter are designed for exclusive use with this product. Do not use them with other products.
- Be sure to use the power cord applicable to your local power specifications. If the product was sold in Japan, use the AC adapter sold with the product with 100 VAC and 50 or 60 Hz.
- When storing the product, do not leave it under direct sunlight or by heaters. It may be discolored, deformed, or damaged.
- Do not place this product in any humid, dusty, salt bearing wind, or vibrating locations. Use it under the following environmental conditions:
Temperature : 0°C~ 40°C Humidity : 30%~ 85%(No condensation)
- Do not put your finger between the arms when moving the arm. You may pinch your finger and result in injury.
It is recommended to attach the supplied caution sticker to the product.
- Use a soft, dry cloth for cleaning.
Do not use any volatile solvent such as thinner or benzene.
- Do not point the lens directly to the sun. It could degrade the imaging capability.
- Luminescent and Black Spots
There may be some pixels that do not properly operate due to the use of CMOS Area Image Sensors made-up of many pixels.
Though luminescent or black spots may be found on the screen, it is a phenomenon peculiar to the CMOS Area Image Sensors and is not a malfunction.
- A protection sheet is attached to the touchscreen at the factory to avoid damage during transportation. Remove the sheet before use.
Do not strongly press the touchscreen or press it with sharp objects. This may result in damage or malfunction to the touchscreen.
- Follow the guidelines below to prevent the unit from dropping or overturning.
 - Use the product on a stable base, desk, or table. Do not place the product on an unstable base or slanted location.
 - Place or wire the product so as to prevent the cables from being pulled or drawn.
- Never hold the product by the arm or the camera head. Carry the product by holding the lower part of the main unit in both hands after folding the arm and the camera head.
- Pay careful attention when using (including setting-up and storing) or carrying the product to prevent the camera head from receiving any shocks.
- After folding the product, do not place heavy object on the arm.
- Do not look directly into the LED light. If you look directly into it at pointblank range, your eyes may be injured.
- The LED may get hot after using it for long hours. Do not touch it directly.
It is recommended to attach the supplied caution sticker to the product.
- Depending on the type of the SD card or USB flash drive, it may not be used with the product.
- Transfer the data from the SD card or USB flash drive onto a device such as a PC to save a backup copy. Malfunction of the product or repairs to it may cause the data saved in the SD card or USB flash drive to be deleted.
- If this product is used for longer than the warranty period, its performance and quality may deteriorate due to the lifetime of its parts. For parts replacement (on chargeable basis), consult the dealer from whom you purchased this product or our branch/office near your location.
- Battery precautions:
 - Remove the battery from the remote control when not in use for an extended period of time.
 - Do not use a rechargeable battery.
 - Do not charge or short-circuit the battery.
 - Follow the regulations of the city or town when disposing of the battery.

- Pay attention to the polarity (+ / -) of the battery.
- Children may ingest small batteries; always keep batteries safe and out of reach. If a battery is swallowed, consult a doctor immediately as this could result in asphyxiation or be an obstacle to digestion, etc.
- If any liquid from a battery leaks onto your skin or clothes, flush the area with clean water immediately. If it gets into your eye, flush immediately with clean water and then contact a doctor.
- **Microphone**
Connecting a microphone other than an electret condenser microphone (a microphone for a computer) may cause malfunction.
- **Audio input port**
The power is supplied to the audio input port (dedicated for the microphone input). Do not connect any audio line-output devices such as a CD/MP3 player to the audio input port.
- **Menu and Icons**
Some functions of this product may not be set or used depending on the operation mode or menu settings.
- **Recording / Playback**
 - Before recording an important scene, make sure to do a test recording to confirm that the camera is working properly.
 - The recording time varies depending on the resolution setting, recording quality setting or type of SD card.
 - Video files that are recorded with this product or converted by the proprietary software can only be played with this product.
 - Be careful not to operate the touchscreen or touch any buttons during the recording. The operation noise may be recorded.
- **Whiteboard Sheet**
 - Use a proper whiteboard marker. If you use a permanent marker on the board, you may not be able to erase it.
 - When writing, write on the whiteboard sheet. If you write directly on the stage, You may not be able to erase it.
It is recommended to attach the supplied caution sticker to the product.
 - Do not leave writing or drawings on the writing surface for an extended period of time. It may stick to the surface and will be difficult to erase.
 - It may be difficult to erase writing or drawings on the surface with a whiteboard eraser. We recommend you used a melamine sponge.
- **Remote control**
The receivable range may be reduced when the product is placed in direct sunlight or near an inverter fluorescent light.
Depending on the surrounding environment, the receivable range may be shorter or the sensor may fail to receive any infrared light. In such cases, relocate the product or shield the light source.
- **Network Function (For PX-30E only)**
We do not guarantee the performance when the product is connected to the Internet directly. For details of the network settings, consult with your network administrator.
- **Copyright**
Unless used for personal use, it is prohibited strictly under copyright law to use any photo files without the prior consent of the copyright holder. Even if using for personal use, be careful that there could be a situation where video or audio recording is restricted or illegal.

HANDLING PRECAUTIONS

The followings are special precautions against mishandling of the product. Pay close attention to them.

① Installation

Do not place the product on an unstable place or slanted surface.

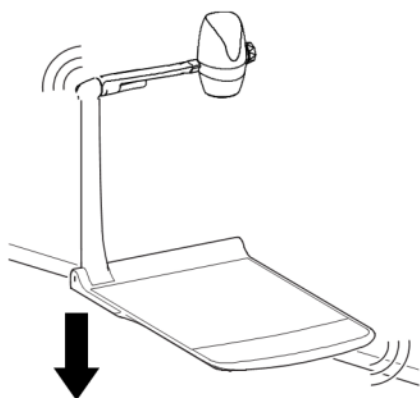

② Carrying the product

To avoid malfunction of the camera, fold the arm before carrying the product. Never hold the product by the arm or the camera head when carrying the product.

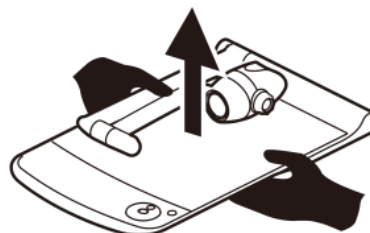

③ Setting Up

When setting up the product, pay attention not to pinch fingers between moving parts.

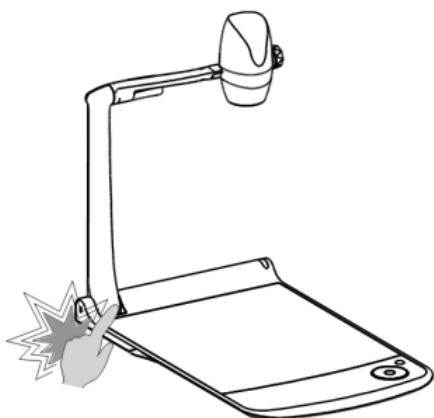

④ Cabling of the AC adapter

Do not wrap the power cable tightly around the AC adapter. By doing so may cause cable disconnection.



■ TABLE OF CONTENTS

■ IMPORTANT SAFEGUARDS	2
BEFORE YOU USE.....	6
HANDLING PRECAUTIONS	8
■ TABLE OF CONTENTS	9
① PREPARATION.....	11
◆ PACKAGE CONTENTS	11
② BASIC OPERATIONS.....	12
②-1 ABOUT THE DOCUMENT CAMERA	12
◆ PART NAMES.....	12
◆ OPERATING PANEL.....	13
◆ REAR PANEL	14
◆ SIDE PANEL	15
◆ MOVING PARTS OF THE DOCUMENT CAMERA	15
◆ SETTING UP.....	16
◆ FOLDING THE DOCUMENT CAMERA.....	16
②-2 SUPPLIED ACCESSORIES	17
◆ REMOTE CONTROL	17
◆ WHITEBOARD SHEET.....	18
◆ CAUTION STICKER	18
②-3 SHOOTING IMAGES.....	20
◆ CONNECTING TO A PROJECTOR OR MONITOR	20
◆ TURNING ON/OFF THE POWER.....	20
◆ ADJUSTING THE SIZE	21
◆ AF (AUTO FOCUS).....	22
◆ USING THE LCD TOUCHSCREEN.....	23
◆ ADJUSTING THE BRIGHTNESS.....	24
◆ TURNING ON/OFF THE LED LIGHTING	25
◆ SELECTING THE IMAGE SOURCE.....	26
②-4 CONFIGURING THE SETTINGS	27
◆ HOW TO CONFIGURE THE SETTINGS	27
◆ DETAILS ABOUT FUNCTIONS	32
③ ADVANCED OPERATIONS	34
③-1 USING SD CARD/USB FLASH DRIVE.....	34
◆ RECORDING.....	35
◆ DISPLAYING RECORDED FILES.....	37
③-2 ABOUT RS-232C.....	42
◆ CONNECTION VIA RS-232C.....	42
③-3 ABOUT NETWORK FUNCTION (FOR PX-30E ONLY)	43
③-4 FIRMWARE UPDATE PROCEDURE	43
③-5 ABOUT EIT(ELMO INTERACTIVE TOOLBOX).....	44
③-6 ABOUT SECURITY SLOT	44
③-7 USING AUTO LOCK.....	44
③-8 USING WOL [WAKE ON LAN] FEATURE (FOR PX-30E ONLY).....	45
③-9 USING IN MASS STORAGE MODE	45
③-10 Using the MF mode	46
③-11 Using the AV control mode (for PX-30E only)	46
④ ERROR MESSAGES	48
⑤ TROUBLE SHOOTING.....	49
⑥ SPECIFICATIONS	51
■ TRADEMARKS AND LICENSES	53

MAIN FEATURES

★High-Definition 4K Image

With the 12Mega pixels CMOS sensor, the PX-10E/30E can produce high-definition images with max. 4K resolution.

※The PX-10E cannot output 4K images. The max output resolution is 2K.

★Natural, Smooth Image

The PX-10E/30E can output 2K images at 60fps.

High definition and smooth video images can be fully displayed without degrading the image quality.

★Maximum excitement generated by state-of-the-art zoom – Optical zoom, Digital zoom, Sensor zoom

The PX-10E/30E are equipped with 12x Optical zoom and 2x Sensor zoom. 24x zooming without image degradation is possible.(Total 288x zooming together with 12x digital zoom.)

★Both A4 portrait image and A3 landscape image can be captured, respectively, in HDMI output mode

By changing the settings of the angle of view and resolution of the output image, you can capture full A4 portrait image and A3 landscape image respectively.

★Easy to store and carry

Thanks to its thin and lightweight design, the PX-10E/30E can be easily stored and carried.

★Possible to record HDMI input

The PX-10E/30E can record or capture HDMI signals being sent to the unit.

The HDMI signals being sent to the unit can be output as HDMI signals, RGB signals, and HDBaset signals (for PX-30E only).

★Extendable with HDBaset (for PX-30 only)

Using the LAN cable, the PX-30E can transmit uncompressed 2K video signals up to 100m at high frame rate, without delay.(For 4K video signals, up to 70m.)

★HDMI1.4 compliant (4K)

The PX-10E/30E support HDMI1.4, which allows the transfer of 4K/2K video signals and the network connection in a single cable.

★USB3.0 compliant (4K)

The PX-10E/30E support USB3.0, which allows the high-speed data transfer of max.5Gbps (10 times faster than USB2.0). Suitable for the transmission of large volumes of data such as high resolution image data, audio data, and video data.

★Recording and playback of 4K videos (for PX-30E only)

It is possible to record or playback 4K videos.

★Possible to draw on the stage (can be used as a whiteboard)

By placing the supplied whiteboard sheet on the stage, you can draw directly on the sheet with a whiteboard marker and shoot it.

★Bright LED lighting

The small LED lighting of the PX-10E/30E is designed to reduce glare to a minimum by focusing lights with lenses.

It delivers bright and even illumination to the entire stage.

1 PREPARATION

◆ PACKAGE CONTENTS

The items below are included with this product. If any item is missing, contact the dealer from whom you purchased this product.

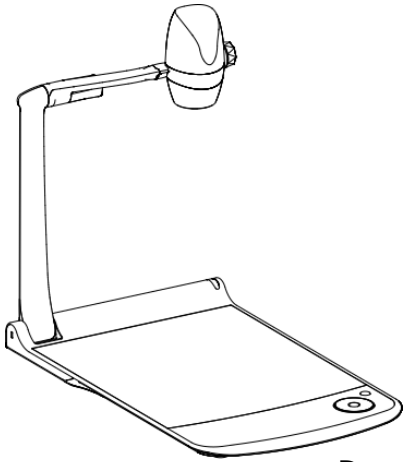

Document Camera

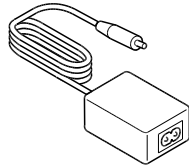

AC adapter

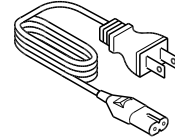

AC power cord
(The shape of the plug differs according to the region in which the product is sold.)

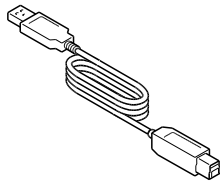

USB3.0 cable
(1.5m)



Lithium coin battery for remote control (CR2025)



Remote control

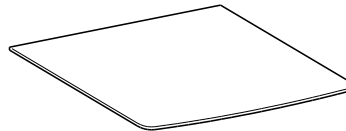

Whiteboard sheet



Melamine sponge
(For Whiteboard sheet)



Cable tie ×3



Screw ×3

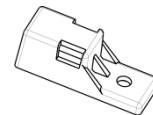

HDMI cable fixture ×3

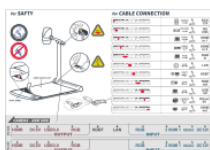

Caution sticker

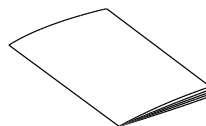

Quick Start Guide



Warranty Card
(For Japan
/ North America only)

② BASIC OPERATIONS

②-1 ABOUT THE DOCUMENT CAMERA



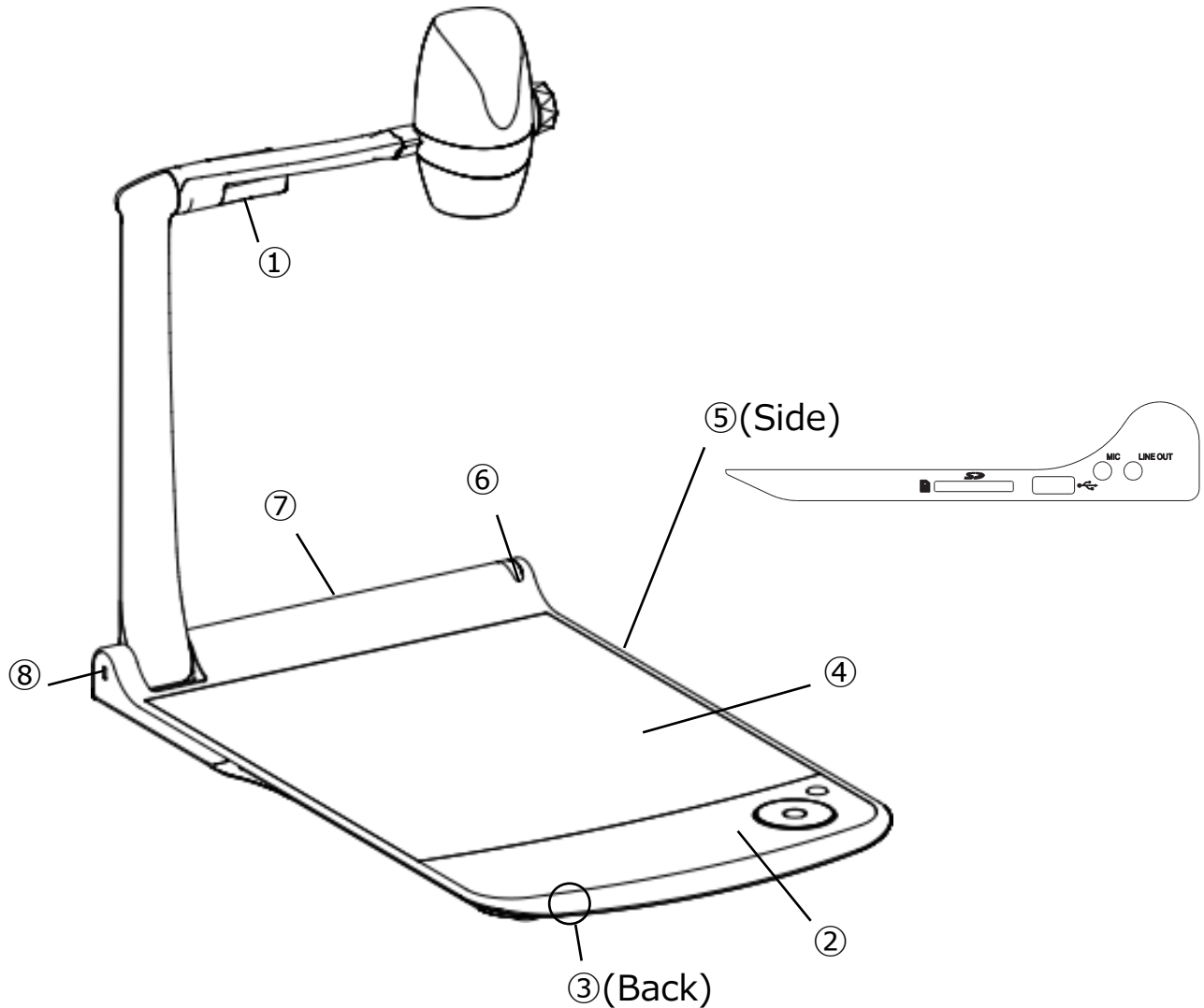





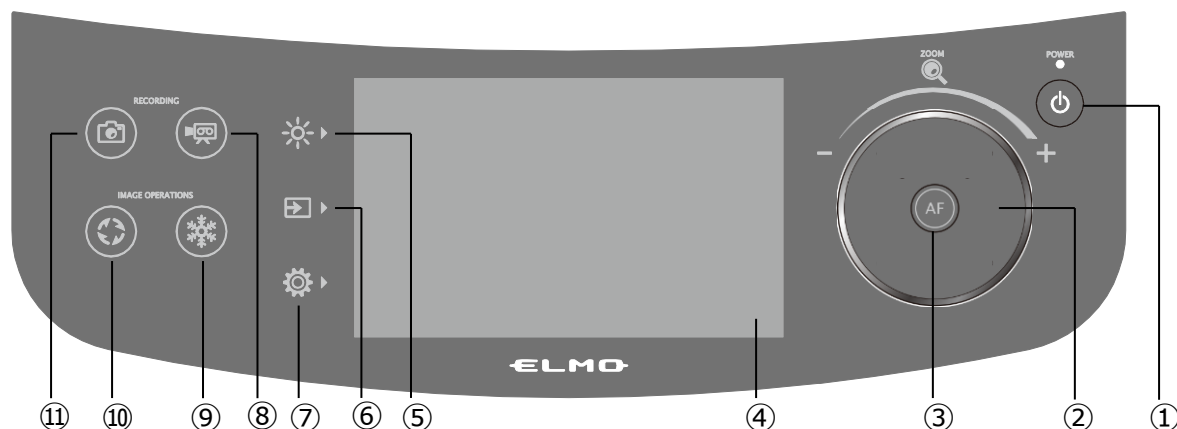

◆PART NAMES



	Name
①	LED lighting
②	Operating panel
③	Speaker
④	Stage
⑤	Side panel
⑥	IR receiver
⑦	Rear panel
⑧	Security slot

◆ OPERATING PANEL



Mark	Name	Function	
①	 Power	To ON/OFF the power. (⇒P.21)	
②	 Zoom jog dial	Rotating counter clockwise: Zoom out. Rotating clockwise: Zoom in. (⇒P.21)	
③	 AF	The auto focus works once when the AF button is pressed. (⇒P.22)	
④	 LCD touchscreen	Images being output is displayed with the OSD menu for configuration of various settings. (⇒P.23) When displaying video, the focus is on the point you tapped.	
⑤		Brightness	To display the menu for brightness settings. (⇒P.24)
		Lighting	To ON/OFF the LED lighting.
		Anti-reflection	To ON/OFF the anti-reflection function.
		Iris	To adjust the brightness. Slide bar: 0~18 (Default value :11)
⑥		Select image	To display the Select image menu. (⇒P.26)
		Camera	To display the camera image.
		USB/SD	To display the USB/SD menu for displaying still images or playing video files.
		HDMI - 1	To display images being input to the HDMI in 1 port.
		HDMI - 2	To display images being input to the HDMI in 2 port.
RGB	To display images being input to the RGB in port.		
⑦		Settings	To display the menu for configuration of various settings. (⇒P.27)
		System	To display the menu for configuration of the system.
		Image Quality	To display the menu for configuration of the camera image.
		Network	To display the menu for configuration of the network function.
	Product Information	To display the information of the version and license of the camera.	
⑧	 Recording	To start and stop recording. (⇒P.36)	
⑨	 Freeze	To pause and restart the camera image. (⇒P.32)	
⑩	 Image rotation	To rotate the camera image. (0°/90°/180°/270°) ※In the System Setting menu, the rotation angle can be selected between 90°and 180°. (⇒P.29)	
⑪	 Capture	To save the currently displayed image as a still image. (⇒P.35)	

※An operation sound is heard when the operating panel is pressed down.

The operation sound can be adjusted in the Op. sound vol. setting. (⇒P.28)

CAUTION

The touchscreen is made of glass. Pay attention to the followings to avoid glass breakage and injury.

- Do not rub or press the touchscreen with a sharp object such as a knife.
- Do not press the touchscreen strongly by finger or do not apply weight to the touchscreen.
- Do not rub the touchscreen with a hard object.
- Do not hit the touchscreen with a hard object or do not drop it onto the touchscreen.
- Do not put an object on the touchscreen.
- Gently wipe the surface with a soft cloth to remove dirt.

Pay attention to the followings in order to maintain the performance of the touchscreen.

- Do not stick adhesive tape on the touchscreen.
- A protective sheet is attached to the surface of the touchscreen to avoid scratches during transportation. Remove the sheet gently before use.

◆ REAR PANEL

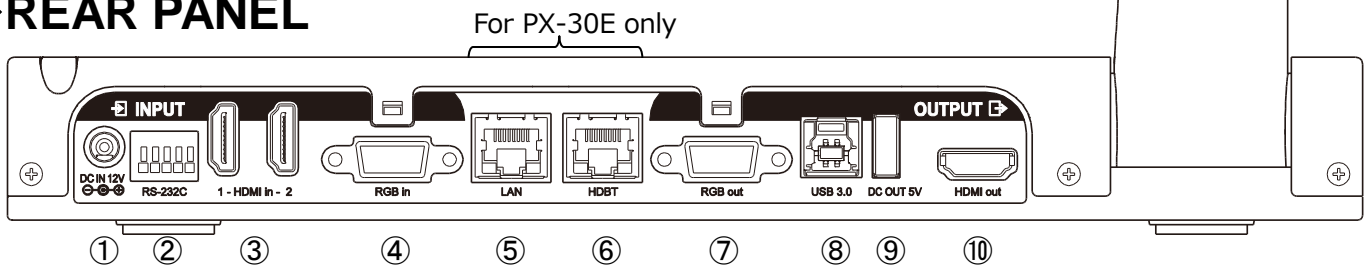

		Name	Function
Input	①	DC IN 12V	To connect the DC plug of the supplied AC adapter. (DC12V)
	②	RS-232C	To connect the RS-232C cable (commercially available) to control the PX-10E/30 E from a PC.
	③	HDMI in 1 HDMI in 2	To connect the HDMI cable (commercially available) to input HDMI images and audio. [HDMI TYPE-A]
	④	RGB in	To connect the RGB cable (commercially available) to input analog RGB images. [mini DSUB15pin]
Output	⑤	LAN (for PX-30E only)	To connect the LAN cable (commercially available) to control the PX-10E /30E from a PC or transfer images over the network. [RJ45]
	⑥	HDBaseT (for PX-30E only)	To connect the LAN cable (commercially available) to connect the PX-30E and a device which has the HDBaseT port. [RJ45] ※1
	⑦	RGB out	To output RGB images. [mini DSUB15pin]
	⑧	USB3.0B	To connect the USB cable compliant to USB3.0 (super speed USB) to connect the PX-10E/30E and a device which supports USB3.0. [USB Standard-B (USB device)] ※ USB 2.0 cable can also be connected.
	⑨	DC OUT 5V	To supply power to other devices. Use this port for connecting a WHDI dongle or charging a tablet. [USB TYPE-A (USB power supply)] ※2
	⑩	HDMI out	To output HDMI images and audio. [HDMI TYPE-A (HDMI1.4 compliant)]

※1 The maximum transmit distance for 4K video signals at 30fps will be 70m when using the cat 5e LAN cable. The maximum transmit distance for video signals of less than 1080 resolution will be 100m when using the cat 5e LAN cable.

The maximum transmit distance for 4K video signals at 30fps will be 100m when using the cat 6a (or higher) LAN cable.

※2 The maximum current available from the ⑨[DC OUT 5V] port in the rear panel and the ②[USB2.0] port in the side panel is 1.2[A] in total.

◆SIDE PANEL

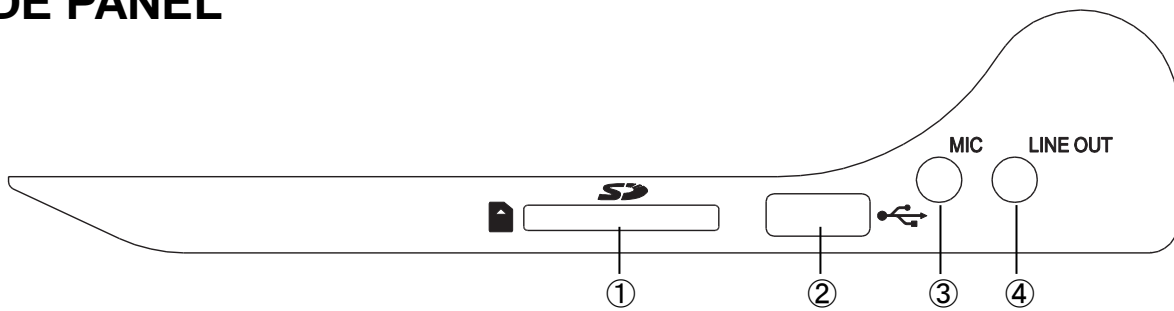

	Name	Function
①	SD	To insert an SD card (commercially available). Push the card again to remove the SD card.
②	USB2.0A	To connect a USB flash drive (commercially available). [USB TYPE-A (USB host)]
③	MIC	To connect a microphone. [Φ3.5mm jack (monaural)] ※Plug-in power type electret condenser microphone supported.
④	LINE OUT	To output audio line. (The audio cable is not supplied and should be purchased separately.) [Φ3.5mm jack (stereo)]

CAUTION

Connecting a microphone other than an electret condenser microphone (a microphone for a computer) may cause malfunction.

◆MOVING PARTS OF THE DOCUMENT CAMERA

The PX-10E/30E can be moved as shown below.

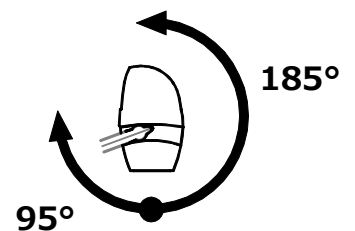
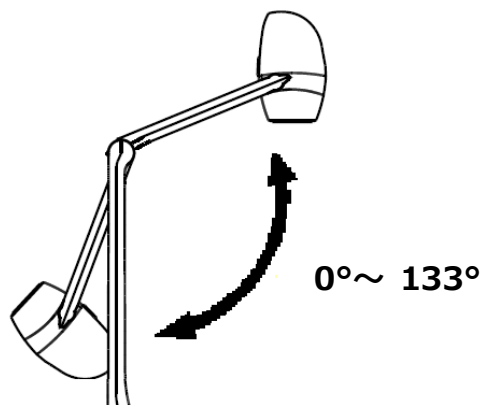
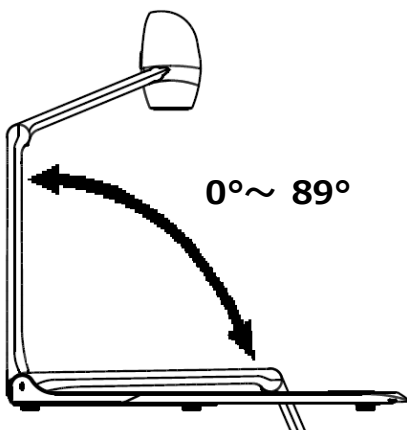

◆ SETTING UP

Place the PX-10E/30E on an even, flat surface. Then set up the PX-10E/30E as shown in the figures below.

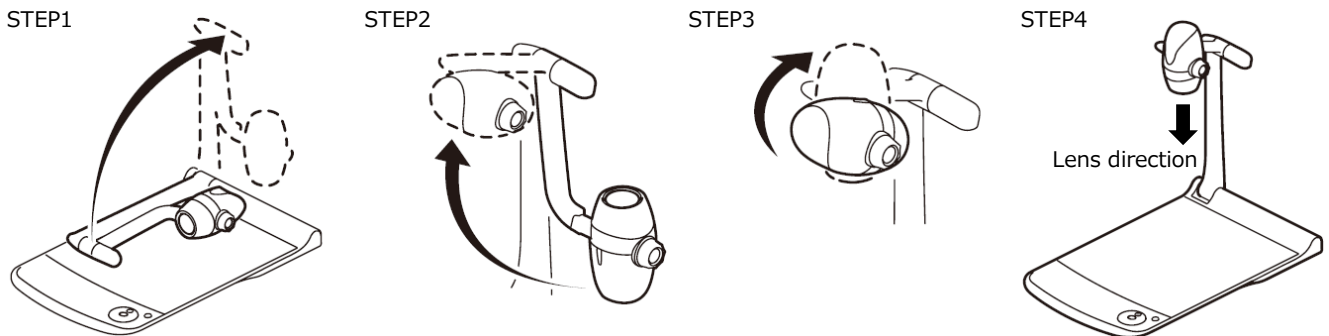

◆ FOLDING THE DOCUMENT CAMERA

After using the PX-10E/30E, fold it as shown in the figures below.

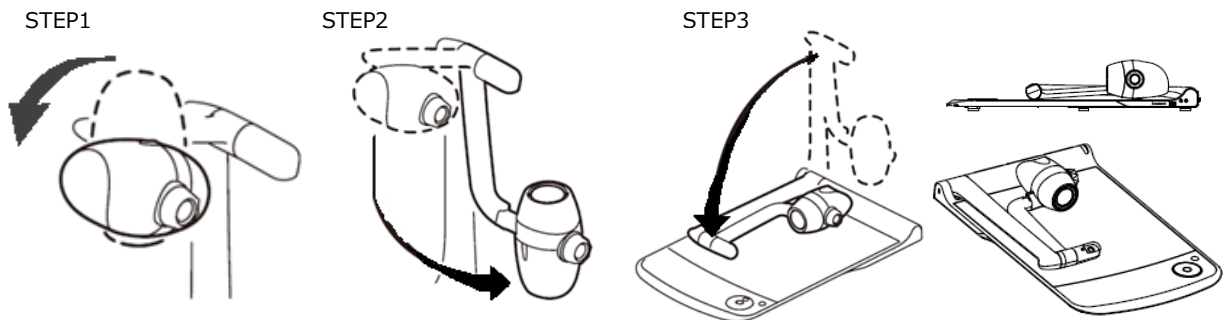

CAUTION

- Be careful not to pinch your fingers when moving the arm or camera head during setup.
- Be careful not to damage the lens when folding the camera arm.
- Rotate the camera head by 64° and rotate the camera arm before folding it. Otherwise, the camera head may hit the stage and damage the lens.
- When folding the camera arm, do not press the camera head.

2-2 SUPPLIED ACCESSORIES

◆ REMOTE CONTROL

PREPARATION OF THE REMOTE CONTROL

Remove the battery case by squeezing the release lock.

Insert the coin battery into the battery case, so you see the positive (+) side facing up.

Then insert the battery case into the remote control.

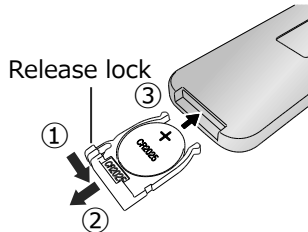

WARNING

Children may ingest small batteries; always keep batteries safe and out of reach. If a battery is swallowed, consult a doctor immediately as this could result in asphyxiation or be an obstacle to digestion, etc.

RECEIVING IR FROM THE REMOTE CONTROL

Point the IR transmitter of the remote control to the IR receiver of the PX-10E/30E, and press the desired button. (⇒P.12)

Receivable range: within approx. 5m



Button	Name/Function	Button	Name/Function
	AF To focus automatically.		LED lighting To ON/OFF the LED lighting.
	Zoom out To shrink the camera image.		Camera To display the camera image.
	Zoom in To enlarge the camera image.		RGB in To display images being input to the RGB in port.
	Default To initialize the brightness settings.		HDMI in 1 To display images being input to the HDMI in 1 port.
	Brightness DOWN To darken the camera image.		HDMI in 2 To display images being input to the HDMI in 2 port.
	Brightness UP To brighten the camera image.		Capture To save the currently displayed image as a still image.
	Image rotation To rotate the camera image. ※1		Recording To start and stop recording.
	Freeze To pause and restart the camera image.		Power To ON/OFF the power.

※1 In the System Setting menu, the rotation angle can be selected between 90° and 180°. (⇒P.29)

◆ WHITEBOARD SHEET

By placing the supplied whiteboard sheet on the stage, you can draw directly on the sheet with a whiteboard marker. As the camera can shoot the annotation made on the whiteboard sheet, you can use the whiteboard sheet like a normal whiteboard.

It may be difficult to erase writings or drawings on the surface with a whiteboard eraser. We recommend you to use the supplied melamine sponge.

The melamine sponge is consumable. When the supplied melamine sponge needs to be replaced, purchase a commercially available melamine sponge.

Be sure to strictly observe the precautions provided when using the stage of the PX-10E/30E as a writing board.

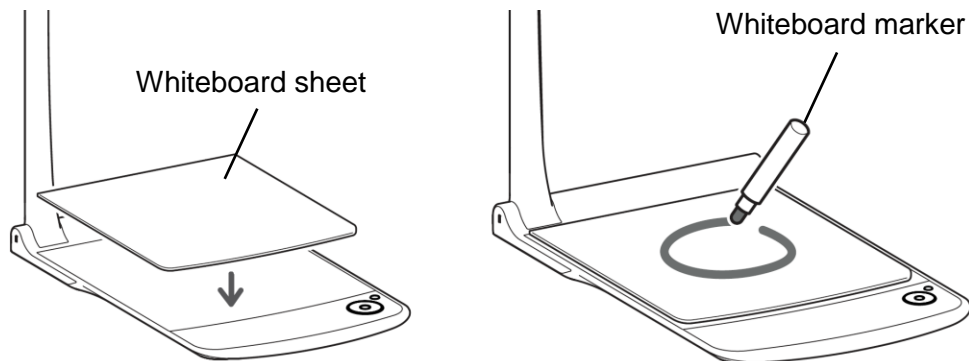

CAUTION

- When drawing, always use a whiteboard sheet. If you draw directly on the stage, you may not be able to erase it. It is recommended to attach the supplied caution sticker to the PX-10E/30E. (⇒P.19)
- Use a proper whiteboard marker. If you use a permanent marker on the board, you may not be able to erase it. It is recommended to attach the supplied caution sticker to the unit. (⇒P.19)
- Do not leave the whiteboard sheet under strong sun light or within humid condition or near a heater as it may change the shape or color.
- Do not leave drawings on the writing surface for an extended period of time. It may stick to the surface and will be difficult to erase.
- When stains cannot be removed by wiping with a dry cloth, wipe with a soft cloth with diluted neutral detergent. Then wipe off the water and remaining detergent with a dry cloth.

◆ CAUTION STICKER

A caution sticker which contains the folding instructions of the camera arm and other precautions is supplied with the PX-10E/30E. Follow the instructions when using the PX-10E/30E. Attach the sticker to the unit as indicated in the sticker.

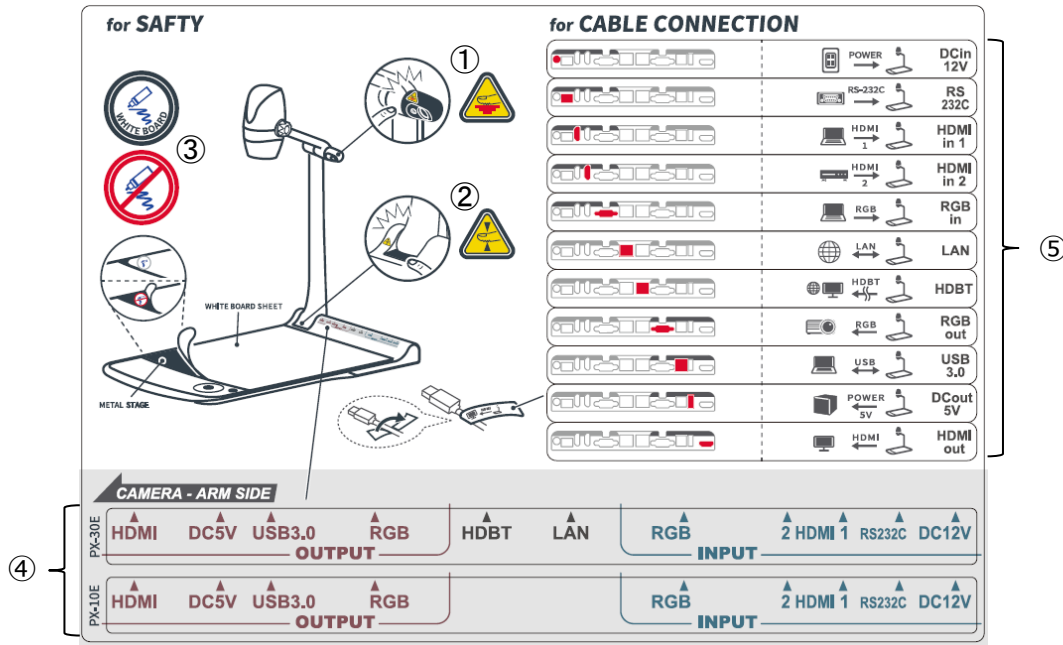

- ① The LED lighting may get hot during use. Do not touch the LED lighting directly when it is on or right after it is turned on.
- ② Be careful not to pinch your fingers when folding the PX-10E/30E.
- ③ Make sure to draw on a whiteboard sheet. If you draw directly on the stage, you may not be able to erase it.
- ④ Attach to the product according to the position of the ports in the back panel.
- ⑤ Attach to the cable according to the name of the port to be connected.

②-3 SHOOTING IMAGES

◆CONNECTING TO A PROJECTOR OR MONITOR

Connect the PX-10E/30E to a projector or monitor with the HDMI cable (commercially available) or the RGB cable (commercially available). Then connect the supplied AC power cord to the AC adapter.

Connect the AC adapter to the unit and connect the AC power cord to the wall outlet.

The LED of the Power button lights up red.

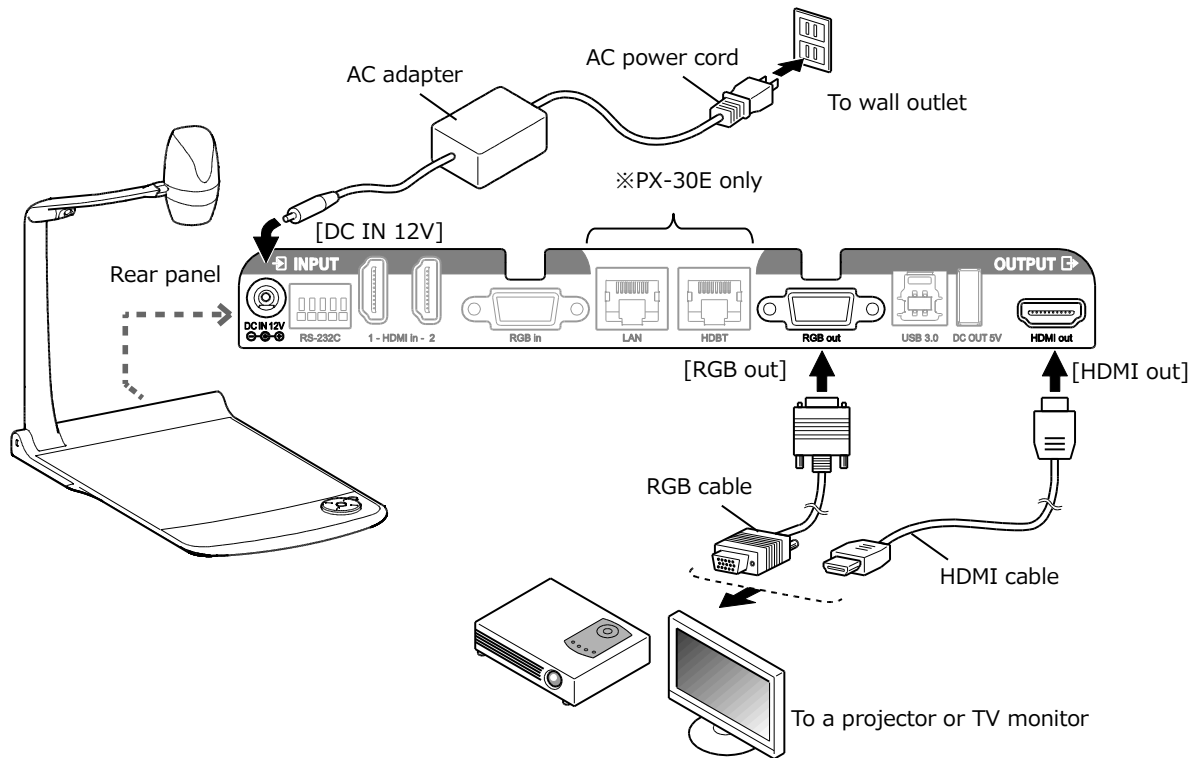







CAUTION

Before connecting the unit to other devices, be sure to turn off the power of all the devices. If the image is not displayed correctly after the resolution setting is set to Auto, change the resolution setting according to the connected device. (⇒P.27)

NOTE

- Zoom ratio: Optical zoom 12x + Sensor zoom 2x, Digital zoom 12x (Total 288x zooming) ※Sensor zoom 2X can be set only when FHD output is used.
- When the optical zoom reaches 12x, it automatically shifts to the sensor zoom. When the sensor zoom reaches 2x, it automatically shifts to the digital zoom.
- Within the digital zoom range, the image quality is degraded.
- ON/OFF of the digital zoom can be set in the System Setting menu. (⇒P.30)
- When the digital zoom is set to OFF, only the optical zoom is available. (The sensor zoom is not available.)

◆TURNING ON/OFF THE POWER

- Press the Power button [] on the operating panel or the Power button [] on the remote control to turn on the power.
The color of the LED of the Power button [] on the operating panel changes from red to blue. (During start up: flashes blue)
- Press the Power button [] on the operating panel or the Power button [] on the remote control to turn off the power.
Press longer for the Power button on the operating panel.
The color of the LED of the Power button [] on the operating panel changes to red.

<Operating panel>

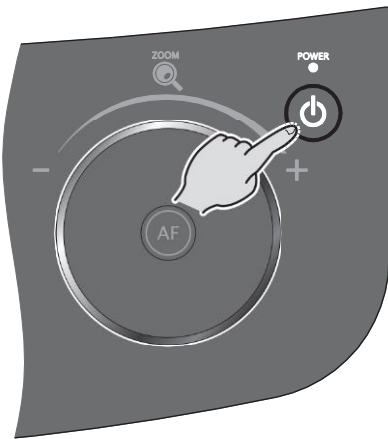

<Remote control>

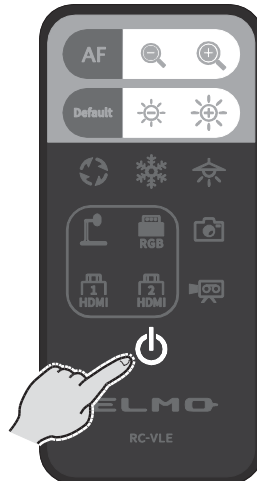

Power OFF
(LED turns red)



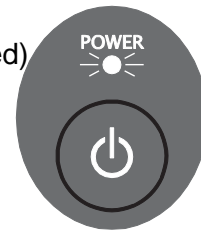

Power ON
(LED turns
blue)



CAUTION

Do not operate the PX-10E/30E while the LED is flashing.

◆ADJUSTING THE SIZE

The size of the image displayed can be adjusted by rotating the zoom jog dial on the operating panel or by pressing the zoom buttons [ / ] on the remote control.

※A zoom bar indicating the zoom position appears on the LCD touchscreen during zoom operation. (Touch operation is disabled during zoom operation.)

Zoom in : To enlarge the subject.

Rotate the Zoom jog dial clockwise or press the [] button on the remote control or rotate the Zoom head dial in the direction of ZOOM-IN.

Zoom out : To shrink the subject.

Rotate the Zoom jog dial counterclockwise or press the [] button on the remote control or rotate the Zoom head dial in the direction of ZOOM-OUT.

<Zoom jog dial>

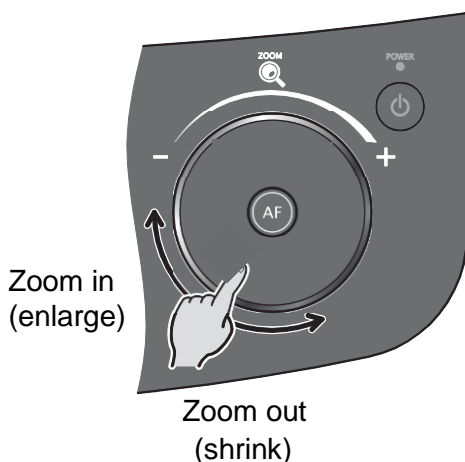

<Remote control>



<Zoom head dial>

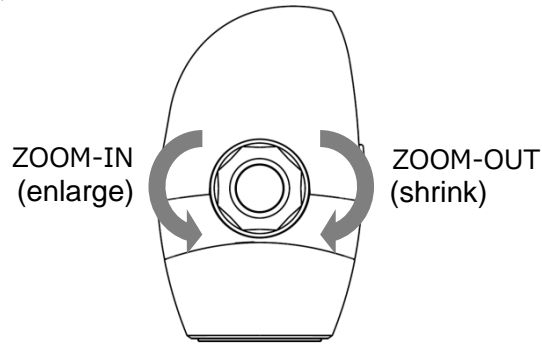

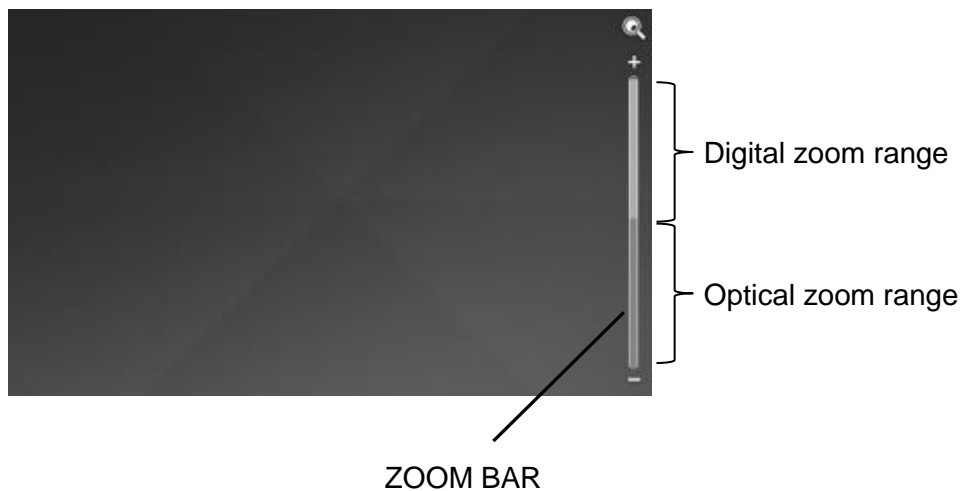

A zoom bar indicating the zoom position appears on the LCD touchscreen during zoom operation. The upper part indicates the digital zoom range and the lower part indicates the optical zoom range.

※The zoom bar appears only on the LCD touchscreen of the PX-10E/30E.



◆ AF (AUTO FOCUS)

The AF (Auto Focus) works once when the AF button [] on the Operating panel or AF button [] on the remote control or AF button in the Zoom head dial is pressed. The AF icon appears on the LCD touchscreen AF operation.

<Zoom jog dial>



<Remote control>



<Zoom head dial>

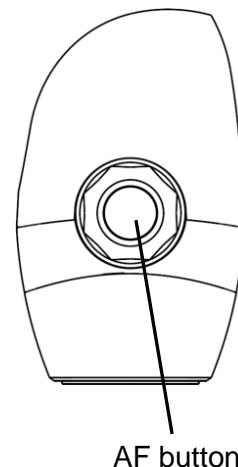

◆ USING THE LCD TOUCHSCREEN

The PX-10E/30E can be controlled using the LCD touchscreen.

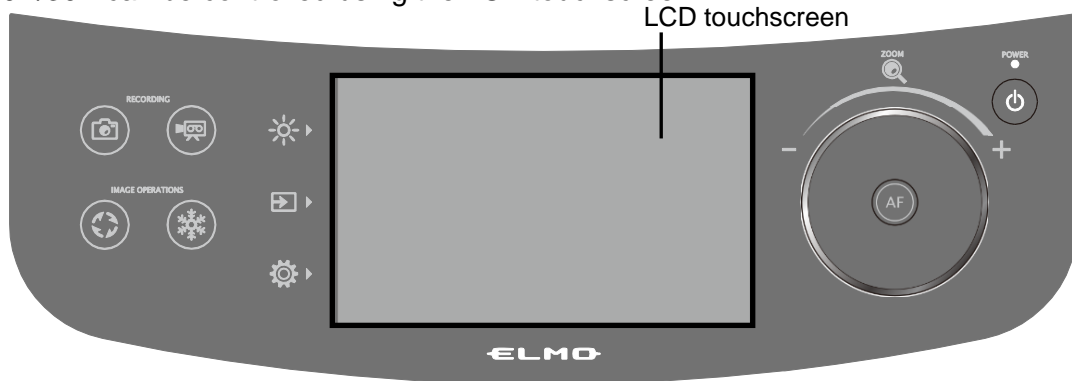

STARTUP SCREEN

When the PX-10E/30E is started, the startup screen appears on the LCD touchscreen, and then the camera image appears.

HOW TO USE THE LCD TOUCHSCREEN

① Tap

By tapping an icon on the LCD touchscreen, you can select a function and operate. The color of the touched icon changes.

② Drag

By sliding your finger across the LCD touchscreen surface while touching the item, you can operate it. When the Presentation function (Mask) is in use, you can move the area.

③ Flick

By quickly moving your finger or flicking on the LCD touchscreen, you can move pages or files.

④ Slide



Horizontal bar: You can change the setting value by sliding the bar left and right while touching the icon of the current setting value.



Vertical bar: You can change the setting value by sliding the bar up and down while touching the icon of the current setting value.

CAUTION

- A protective sheet is attached to the surface of the LCD touchscreen to avoid scratches during transportation. Remove the sheet gently before use.
- Do not press the LCD touchscreen strongly by finger or sharp objects. This can cause damage or malfunction.
- Do not put a thing on the LCD touchscreen.
- The LCD touchscreen may not work properly if you operate it with a wet finger or with two fingers.
- Do not use the product near equipment that generates electrical noise. This can cause malfunction.

◆ ADJUSTING THE BRIGHTNESS

Press the Brightness button [] on the operating panel to display the menu for brightness adjustment. The image brightness can be adjusted by sliding the bar to the right or left, or by using the [ / ] buttons on the remote control.





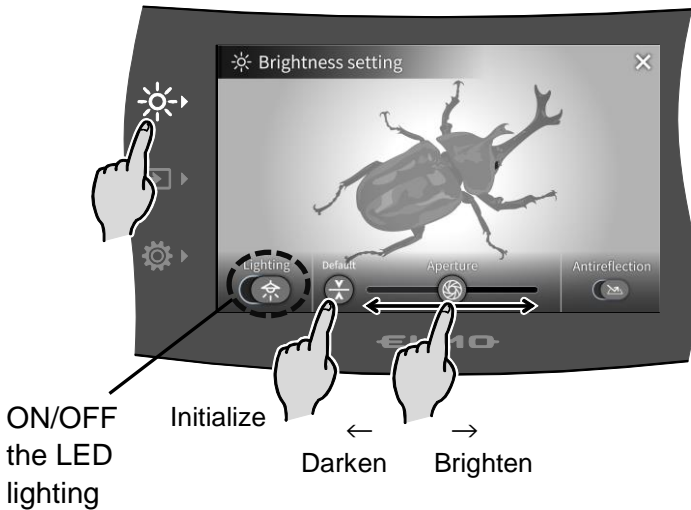



Press the Default button [] on the operating panel or the Default button [] on the remote control to initialize the brightness settings.

<Operating panel>



<Remote control>





Icon		Name	Function
LCD touchscreen	Remote control		
		Lighting	To ON/OFF the LED lighting. OFF ← → ON
	-	Iris (brightness)	To adjust the iris with a slide bar to change the brightness. Iris close (dark) ← → Iris open (bright)
-		Brightness	To change the brightness of the camera image.
		Default	To initialize the brightness settings.
	-	Anti-reflection	To ON/OFF the anti-reflection function. (Reduce light reflection) OFF : Disable ← → ON : Enable
	-	Return	To return to the camera image.

NOTE

- In places where the subject is exposed to bright sunlight (e.g. near a window), or extremely bright lights, the brightness of the screen may not dim sufficiently, even when the iris is closed from the touchscreen or the [] button on the remote control is pressed.
In such cases, to adjust the amount of light, close the curtains or move the subject away from the light.
- The brightness adjustment is not possible when the external input is selected in the input selection menu.

◆TURNING ON/OFF THE LED LIGHTING

Press the Brightness button [] on the operating panel to display the brightness settings menu, and press the lighting icon [] to turn on the LED lighting.

ON/OFF the LED lighting can also be performed from the remote control by pressing the LED lighting button [].

The LED lighting can be rotated by 90°. Adjust the angle according to the subject.

Use the anti-reflection function when there is too much reflection of the light. (⇒P.24)

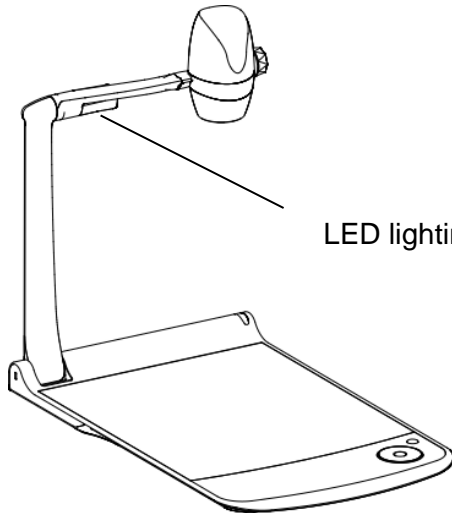

LED lighting (possible to rotate by 90°)

<Operating panel>

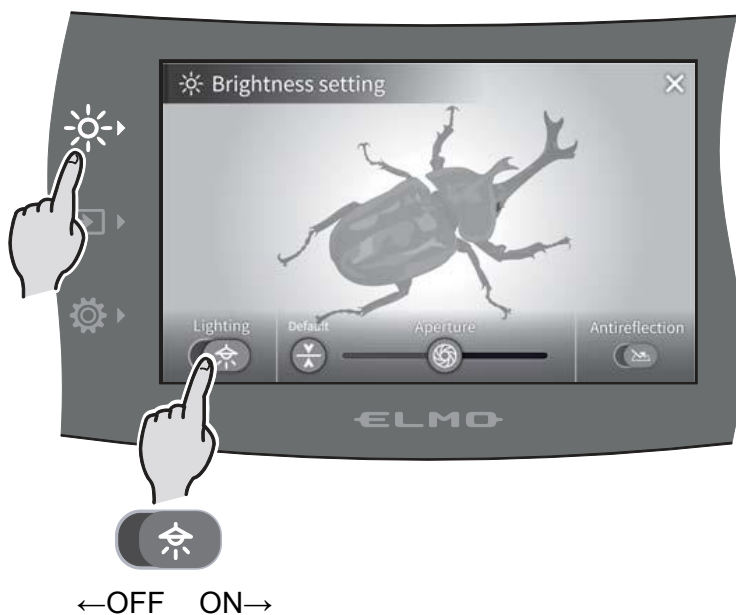

<Remote control>

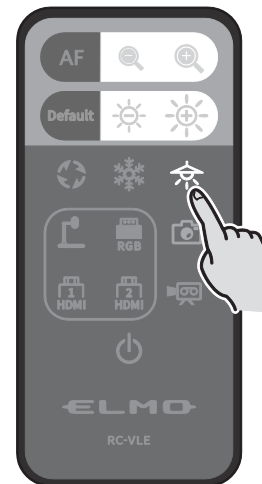

CAUTION

- When you take a picture of a person, turn off the LED lighting.
- The PX-10E/30E is equipped with high-brightness LED. You can safely use it to light up subjects.
Make sure that the light from the LED does not shine directly into your eyes.
- The brightness of the LED will gradually diminish with long-term use. This is not a malfunction of the LED lighting, but a characteristic of the LED.

◆ SELECTING THE IMAGE SOURCE

Press the Select image button [] on the operating panel to display the Select image menu. The image of the selected device is displayed on the LCD touchscreen and external monitor. The input selection can also be performed from the remote control using the input source select buttons. (⇒P.17)

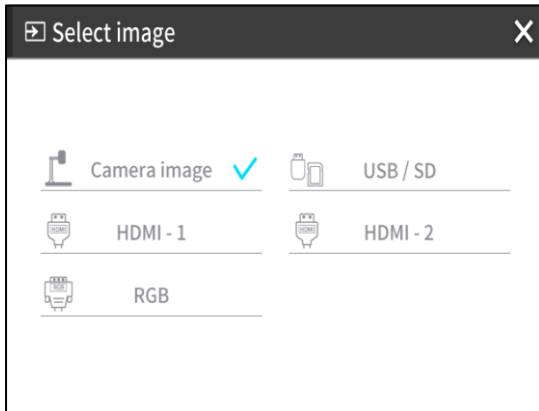

Menu	Function	Pages
Camera image	To display the camera image.	-
USB / SD	To display the USB/SD menu for displaying still image or playing video files.	⇒P.26
HDMI - 1	To display images being input to the HDMI in 1 port.	⇒P.14
HDMI - 2	To display images being input to the HDMI in 2 port.	⇒P.14
RGB	To display images being input to the RGB in port.	⇒P.14

Press [X] button to go back to the screen being displayed previously.

※When RGB is selected, the image being input is not displayed on the LCD touchscreen.

※When HDMI 1 or HDMI 2 is selected, the signals being sent to the unit can be output as USB signals, HDMI signals, RGB signals, and HDBasetT signals (for PX-30E only), and can be recorded or captured.

NOTE

- When using a PC with output mode selection feature, setup according to the following instruction:
 1. Connect a PC to the PX-10E/30E.
 2. Set the output mode of the PC to “EXTERNAL OUTPUT”.
 3. Press the Select image button and select either “HDMI-1”, “HDMI-2”, or “RGB”.
- Do not change the resolution of the image being input while selecting the external input.
- No image will be displayed when HDCP signals are input.

USB/SD menu

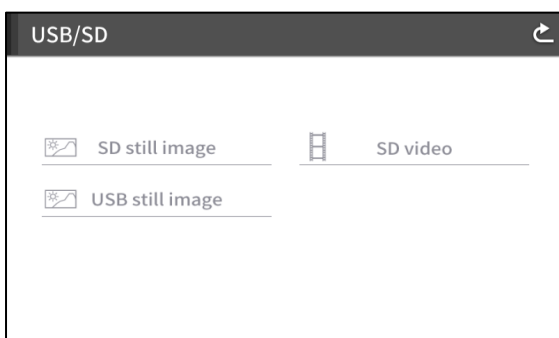

Menu	Function
SD still image	To display the menu to playback still image saved in the SD card.
SD video	To display the menu to play videos saved in the SD card.
USB still image	To display the menu to playback still image saved in the USB flash drive.

2-4 CONFIGURING THE SETTINGS

Each setting of the PX-10E/30E can be configured through the menu (texts or icons) displayed on the screen.

◆ HOW TO CONFIGURE THE SETTINGS

Press the Settings button [] on the operating panel.

The settings menu appears. “System Setting”, “Image Quality Setting”, “Network Settings”, and “Product Information” can be selected from the menu.

[✓ : Default setting (default value)]

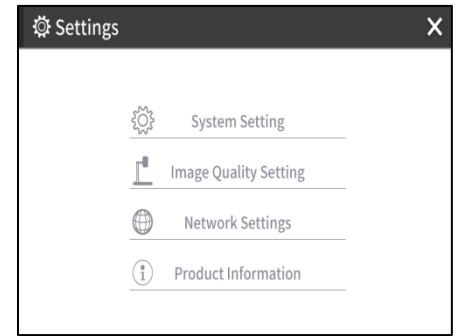

Menu	Function	Pages
System Setting	To display the menu for configuration of the system.	⇒P.27
Image Quality Setting	To display the menu for configuration of the camera image.	⇒P.30
Network Settings	To display the menu for configuration of the network function. (For PX-30E only)	⇒P.31
Product Information	To display the information of the version and license of the camera.	⇒P.31

System Setting (1/5 page)

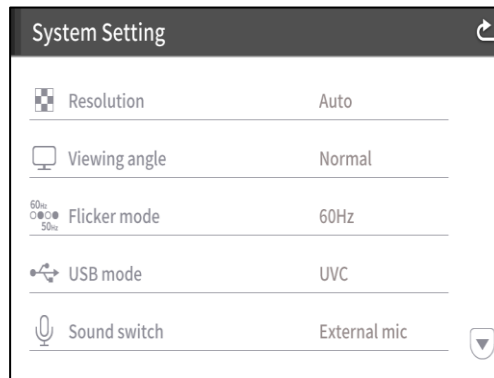

Name	Selection item	Function
Resolution	Auto✓	To set the resolution of the output image. ※The PX-10E does not support UHD (3840 x 2160).
	UHD (3840 x 2160)	
	FHD (1920 x 1080)	
	HD (1280 x 720)	
	UXGA (1600 x 1200)	
Viewing angle ※1	XGA (1024 x 768)	To set the viewing angle of the output image.
	Normal (16:9)✓	
Flicker mode	Full (4:3)	When there is flickering in the image due to the fluorescent light, set to the same value as the power supply frequency of the location where the PX-10E/30E is used. 50Hz: Europe 60Hz: Japan/USA
	50Hz	
	60Hz✓	
	OFF	
	ND Filter	Select this item when there is halation due to flickering. (For example, when shooting outside or when the surrounding environment is too bright.) Flickering may be reduced.

USB mode	To configure actions when the PX-10E/30E is connected to a PC through the USB3.0 port.	
	UVC ✓	To control the PX-10E/30E from a PC.
	Mass storage	To transfer the data from the SD card to a PC.
Sound switch	To select the source of the audio input.	
	External mic ✓	To set the audio source to external microphone.
	HDMI sound	To set the audio source to HDMI in.
	Sound OFF	To mute the audio.

※1 For details about the video output, refer to ⑥ Specifications. (⇒P.51)

(2/5 page)

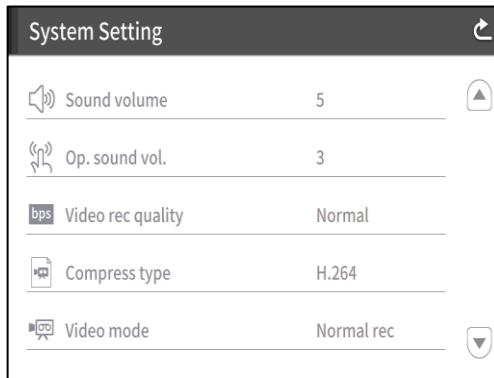

Sound volume	0~10 (Default value: 5)	To configure the HDMI sound volume and the external microphone volume.
Op. sound vol.	0~5 (Default value: 3)	To configure the speaker volume.
Video rec quality	Excellent Quality / High Quality / Normal ✓ / Economy / Fast Economy	To configure the recording bitrate. ※When Excellent Quality or High Quality is selected, the recording time becomes shorter.
Compress type	To select the video compression method. ※1	
	H.264 ✓	To set the video compression method to H.264.
	HEVC	To set the video compression method to H.265.
Video mode	Normal rec ✓	To continuously record the video.
	Time-lapse rec (⇒P.33)	To create a video by combining multiple photos taken at certain intervals. The recording interval can be configured from "Time-lapse".

※1 HEVC(H.265) can achieve image quality equivalent to that of H.264 at half bit rate and half data size. However, it may take longer to process data due to its high compression ratio.

(3/5 page)

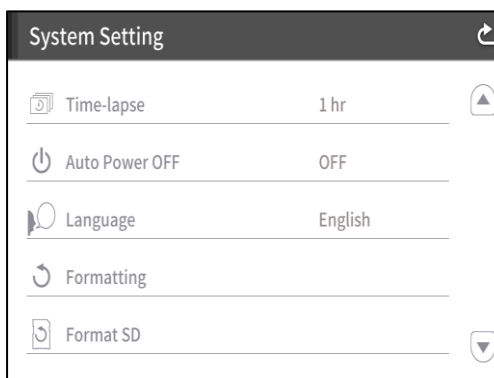

Time-lapse	1min / 10min / 30min / 1hr✓ / 3hrs / 6hrs	To create a 1 second video by combining 30 photos taken at set intervals. (⇒P.33)
Auto Power OFF	OFF✓ / 30min / 1hr / 2hrs / 3hrs	To automatically turn off the power after no operation for a specific period of time.
Language	日本語 / English✓ / Deutsch / Français / العربية	To set the language of the OSD menu.
Formatting	YES / NO	To initialize all the settings.
Format SD	YES / NO	To perform a quick format of the SD card.

(4/5 page)

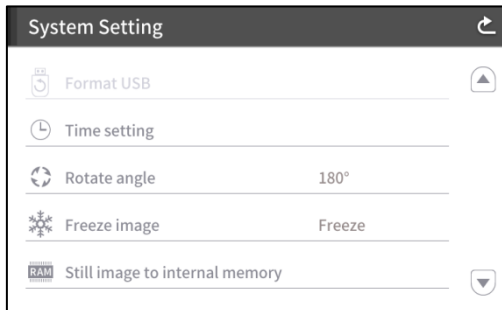

Format USB	YES / NO	To perform a quick format of the USB flash drive.
Time setting	YEAR / MONTH / DAY / HOUR / MINUTES / SECOND	To configure the time setting of the PX-10E/30E. Touch the desired item and configure by using the up and down cursors.
Rotate angle	90° / 180°✓	To set the rotation angle of the image.
Freeze image	Move / Freeze ✓	To set whether to freeze the image on the LCD touchscreen when Freeze function is activated. ※When this setting is set to Move, the image on the LCD touchscreen does not freeze when Freeze function is activated.
Still image to internal memory	Save / Play	To record a still image to the internal memory. Tap "Save" to save.

(5/5 page)

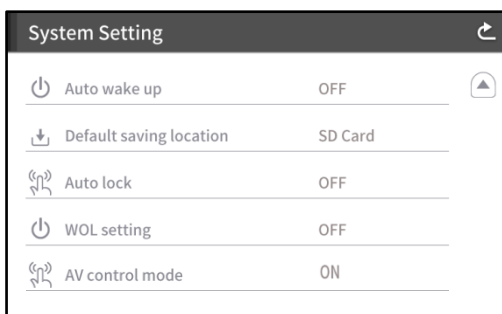

Auto wake up	ON / OFF	When this setting is set to ON, the PX-10E/30E automatically starts up after the AC power is supplied.
Default saving location	SD Card✓ / USB Memory Stick	To set the primary destination for saving still image or videos.
Auto lock	ON / OFF✓	To disable the functions of buttons on the operating panel or the LCD touchscreen. (⇒ P.44)
WOL setting (for PX-30E only)	ON / OFF✓	To turn on the PX-30E remotely from a PC via the LAN cable. (⇒P.45)
AV control mode (for PX-30E only)	ON✓ / OFF	By connecting the HDBaseT cable, you can control a projector easily. (⇒P.46)

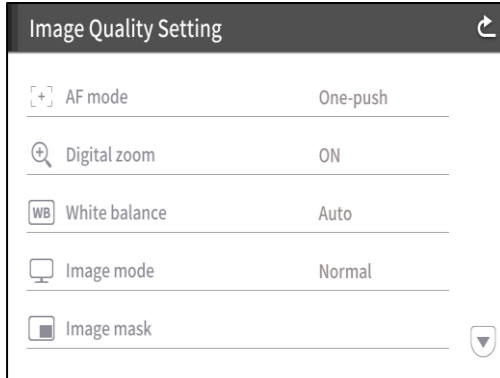

Image Quality Setting

(1/2 page)

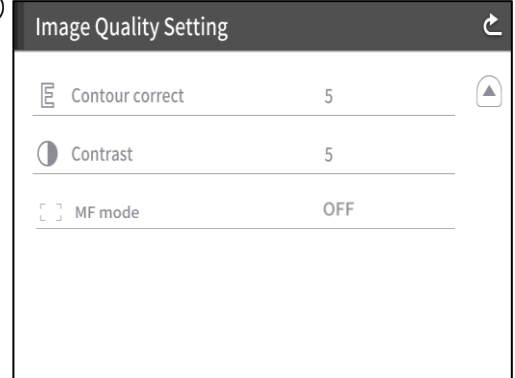

(2/2 page)



Name	Selection item	Function
AF mode	Zoom sync	To perform auto focus only once after zooming.
	One-push ✓	To perform auto focus only once when [] on the operating panel or [] on the remote control is pressed.
Digital zoom	ON ✓	To enable the digital zoom.
	OFF	To disable the digital zoom.
White balance	Auto ✓	To always adjust the white balance automatically. The white balance is adjusted automatically to ensure a more natural color according to the characteristics of the object.
	One-push	To automatically adjust the white balance only once when this setting is selected.
	Flourescent	To adjust the white balance according to the environment under flourescent light.
	Indoors	To adjust the white balance according to indoor environment.
	Outdoors	To adjust the white balance according to outdoor environment.
Image mode	Normal ✓	Suitable for displaying documents.
	Emphasis	To emphasize the image.
	Color emphasis	Suitable for displaying colorful subjects.
	Black/white	To display black and white images.
	DLP projector	Suitable for projecting images with a projector.
Image mask (⇒P.32)	To mask a part of the image selected by dragging on the screen with your finger.	
Contour correct (⇒P.33)	0~10(Default value: 5)	To adjust the level of edge enhancement.
Contrast (⇒P.33)	0~10(Default value: 5)	To adjust the contrast of the image.
MF mode (⇒P.46)	ON	By rotating the jog dial on the Operating panel, you can manually adjust the focus.
	OFF ✓	

Network Settings (for PX-30E only)

To display the network configuration area as well as the network information assigned to a connected device. Connect the LAN port on the back panel to the network with the LAN cable. (⇒P.14)

By connecting to the network, the following actions are possible.

- To operate the PX-30E with commands. (You can control the PX-30E from your PC.)

MAC Address	MAC address set in the PX-30E
inet	To select between static and DHCP.

When selecting “DHCP”, a unique IP address is assigned to the PX-30E automatically.

If you need to configure the IP address manually, select “static”.

When performing the operation with commands, connect your PC to the PX-30E with the LAN cable after installing a serial communication software on your PC.

Tap the item to display the on-screen keyboard with numeric keypad. Then enter the necessary information manually.

Network Settings

MAC Address 00099A112244

inet static DHCP

IP Address 0.0.0.0

Net Mask 0.0.0.0

Gateway 0.0.0.0

DNS1 192.168.1.1

DNS2 192.168.1.2

Hostname

Numeric keypad

keyboard

IP Address	IP Address
Net Mask	Net Mask
Gateway	Gateway
DNS1	DNS1
DNS2	DNS2
Host Name	Host Name

CAUTION
For details about the commands, contact our branch/office near your location.

Product Information

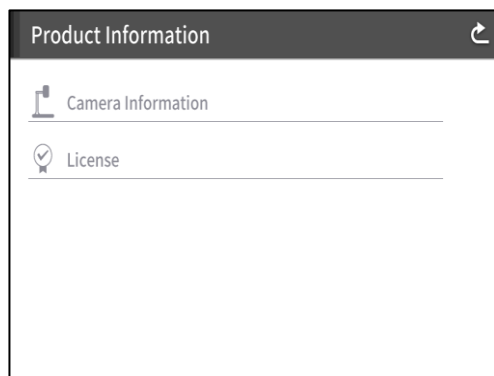



Camera Information	Production Name	Product name (e.g. PX-30E)
	Serial Number	Serial number of the PX-10E/30E
	Production Version	Version of the PX-10E/30E
	CMOS	Version of CMOS FPGA
	MAIN	Version of MAIN FPGA
	PANEL	Version of PANEL FPGA
	HDBaseT (for PX-30E only)	Version of HDBaseT
	Production Date	Production date of the PX-10E/30E
License	The license information used for the PX-10E/30E is displayed.	

◆ DETAILS ABOUT FUNCTIONS

FREEZE



To pause the camera image.

Press the Freeze button [] on the operating panel or [] on the remote control to pause the image.

You can set whether to freeze the image on the LCD touchscreen when Freeze function is activated from the System Setting. (⇒ [Move/Freeze] : P.29)

IMAGE ROTATION

To rotate the camera image.

Press the Image rotation button [] on the operating panel or [] on the remote control to rotate the image. (⇒P.13、 P.17)

You can set the angle of image rotation from the System Setting. [90°/180°] (⇒P.29)

MASK

To mask a part of the image.

How to use MASK

Press the Settings button [] on the operating panel while the camera image or a playback image is displayed on the monitor. Select “Image mask” from the “Image Quality Setting”. (⇒ P.30)

By pressing “Image mask”, you can setup the mask tool on the LCD touchscreen.



Select the area to be masked by dragging on the screen with your finger. (The color of the mask is blue.)

Tap [] to apply. (The color of the mask is black.)

The number of mask that can be applied to the image is one. When [] is tapped after creating a new mask, a previously created mask disappears.

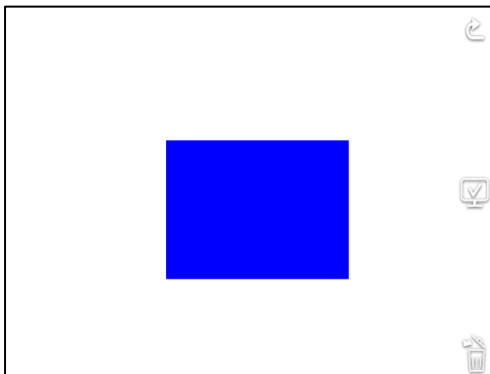
Tap [] to remove the applied mask.



	RETURN	To return to the previous screen.
	APPLY	To output the contents of the LCD touchscreen to the connected device.
	DELETE	To remove the created mask.

NOTE

- The mask function is available only when the “Camera image” is selected in the Select image menu.
- It is not possible to record the image with a mask.
- The mask does not follow the change of the lens (zoom in/ zoom out, lens direction). It is advisable not to use the mask function for the purpose of hiding confidential information.

CONTOUR CORRECT

To enhance the edge of the image. (0~10: 11 levels) Default value 5 (⇒P.30)

As the value gets smaller, the image becomes softer. As the value gets larger, the image becomes sharper.

While the image gets sharper by setting to a larger value, it may take more time to process the image or the file size may become large.



※This function is available only when [Camera image] is selected in the Select image menu. (⇒P.26)

How to use CONTOUR CORRECT

Press the Settings button [] on the operating panel while the camera image or a playback image is displayed on the monitor. Select "CONTOUR CORRECT" from the "Image Quality Setting".

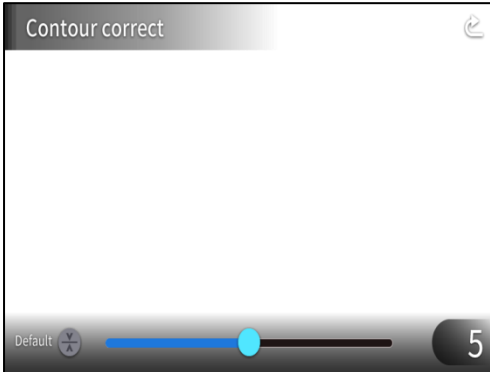
(⇒P.30)

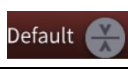
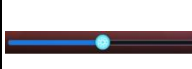

	RETURN	To return to the Image Quality Setting menu.
	DEFAULT	To return the setting value to 5 (default value).
	SLIDE BAR	To set the edge enhancement value by moving the slider. (0~10)
	SETTING VALUE	To display the current setting value.

CONTRAST



To increase the contrast of the image. (0~10: 11 levels) Default value 5

While the image gets sharper and becomes more vivid by setting to a larger value, the glare on the image may increase.

How to use CONTRAST

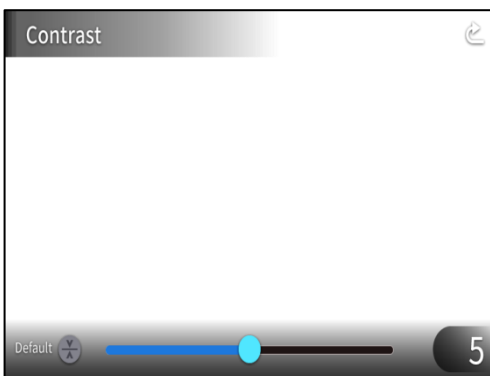
Press the Settings button [] on the operating panel while the camera image or a playback image is displayed on the monitor. Select "Contrast" from the "Image Quality Setting". (⇒P.30)

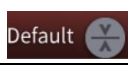

	RETURN	To return to the Image Quality Setting menu.
	DEFAULT	To return the setting value to 5 (default value).
	SLIDE BAR	To set the contrast value by moving the slider. (0~10)
	SETTING VALUE	To display the current setting value.

TIME-LAPSE

To create a 1 second video by combining 30 photos taken at set intervals (1minute, 10minutes, 30minutes, 1hour, 3hours, 6hours).

For example:

When setting to 1minute ⇒ Record 30minutes = 30frames of images = Video length: 1second

When setting to 1hour ⇒ Record 1 week (168hours) = 168frames of images
= Video length: 5.6seconds

CAUTION

- If the video file length exceed 2hours or video file size exceeds 4 GB, a new file will be created automatically in the same project.

③ ADVANCED OPERATIONS

③-1 USING SD CARD/USB FLASH DRIVE

With the PX-10E/30E, you can record the camera image as a still picture to an SD card, USB flash drive, or internal memory. Also, you can record the camera image as a video to an SD card.

The image data recorded in an SD card, USB flash drive, or internal memory can be displayed on the monitor.

Insert the SD card (SD/SDHC/SDXC, commercially available) or USB flash drive (commercially available) into the slot on the side panel before starting the operation. (⇒P.15)

※Recording is not possible if either an SD card or USB flash drive is inserted.

- Video recording (HEVC (H.265) / H.264): SD
- Still image recording (JPEG): SD / USB flash drive / internal memory
 - ※For video recording, an SD card with class10 speed or above is required.
 - ※You can select the video compression method (HEVC (H.265) / H.264) from the System Setting. (⇒P.28)

NOTE

- About SD card
 - We recommend you to format the SD card with the PX-10E/30E before using it.
 - Video recording is only possible to an SD card (SD / SDHC / SDXC) with class10 speed or above.
 - We recommend you to use an SD card with class 10 speed or above.
- About USB flash drive
 - Use a USB flash drive up to 32GB.
 - We recommend you to format the USB flash drive with the PX-10E/30E before using it. (⇒P29: FORMAT USB FLASH DRIVE)
- It may take some time to recognize the memory card after inserting the SD card / USB flash drive or to record images to the memory card.
- Do not remove the memory card (SD card / USB flash drive) when the PX-10E/30E is accessing the memory card (during recording or playback).
- Formatting the SD card/USB flash drive.

When you need to format the SD card/USB flash drive, insert it into the PX-10E/30E and perform formatting. (⇒P.29)

- ① Press the Settings button [] on the operating panel and select "Format SD" or "Format USB" from the "System Setting".
- ② Select a media to be formatted and select "YES" to format it.
If you do not want to format, select "NO".

◆ RECORDING

STILL IMAGE

Recording using the operating panel

- ① Press the Capture button [] on the operating panel to record a still image.
- ② Recording is performed when a mark appears on the preview image displayed on the LCD touchscreen.

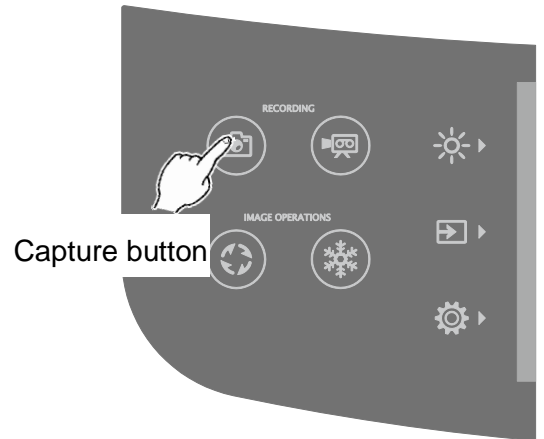

Recording using the remote control

- ① Press the Capture button [] on the remote control.
- ② Recording is performed when a mark appears on the output image.





VIDEO

Recording using the operating panel

① Press the Record button [] on the operating panel.

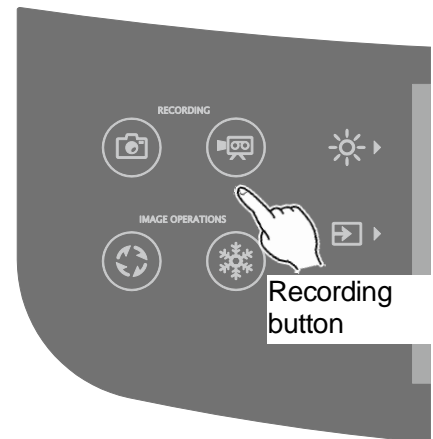
② Video recording begins when a mark appears on the LCD touchscreen.





③ When the Recording button [] on the operating panel is pressed again, video recording stops and the mark disappears.

Recording using the remote control

① Press the Recording button [] on the remote control.

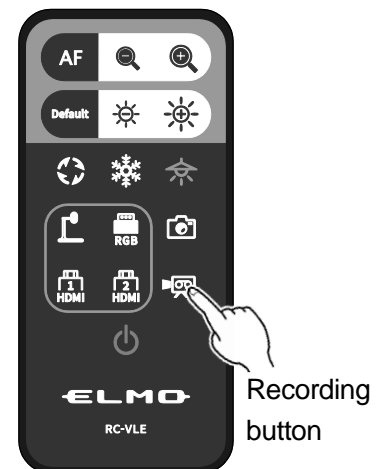
② Video recording begins when a mark appears on the LCD touchscreen.



③ When the Recording button [] on the remote control is pressed again, video recording stops and the mark disappears.

NOTE

- When recording video onto an SD card, use an SD card that has fast read and write speeds (class 10 or above). If you use an SD card that has slow read and write speeds, the video quality may be degraded.
- When both SD card and USB flash drive are inserted into the PX-10E/30E, the primary recording destination is SD card. When recording a still picture to a USB flash drive, go to the System Setting and select "USB Memory Stick" from the "Default saving location". (⇒P.29)

RECORDING SPECIFICATIONS (STILL PICTURE / VIDEO)

< STILL IMAGE RECORDING >

Recording media	SD card, USB flash drive, internal memory
Recording size	Determined according to the settings of Resolution and Viewing angle. (⇒P.27)
Image type	JPEG
File format	DCF 2.0 compliant A thumbnail is created each time a still picture is recorded. (Extension: jpg)

< VIDEO RECORDING >

Recording media	SD card, SDHC card, SDXC card (class10 or above) ※1
Video format	H.264 / HEVC(H.265)
Recording mode	Normal recording / Time-lapse recording
Recording file size / frame rate	In Normal recording: Varies according to the Video rec quality setting (⇒ P.28) In Time-lapse recording: 30fps (fixed)
Audio recording	Select from the Sound switch menu. (⇒P.28)
File format	DCF 2.0 compliant (mp4) A thumbnail is created each time a video is recorded. (Extension: thm)
Recording limit	Maximum video file size: 4GB Maximum video length: 2hours ※If the video file length exceed 2hours or video file size exceeds 4 GB, the current recording file is closed and the recording restarts with a new file. ※If the AC power supply is cut off during recording, the video file may be damaged and cannot be played. ※For EU models, video recording will stop automatically if the video length reaches 29min. 50sec. (This applies only for Normal recording.)

※1 Only still image can be recorded to a USB flash drive and the internal memory.

◆ DISPLAYING RECORDED FILES

THUMBNAIL DISPLAY (LIST OF STILL IMAGE / VIDEOS)

BASIC OPERATIONS

- ① Press the Select image button [] to select [USB/SD] in the Select image menu. (⇒P.26)
Select a media to be displayed. (SD still image / SD video / USB still image)

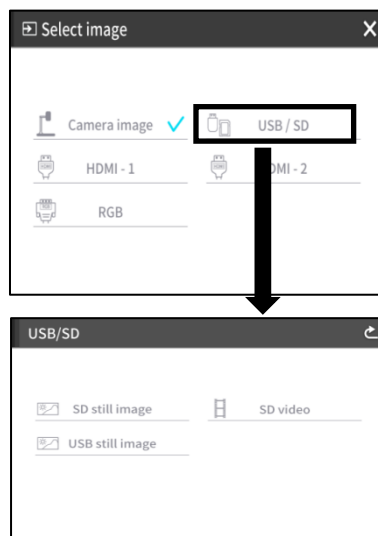
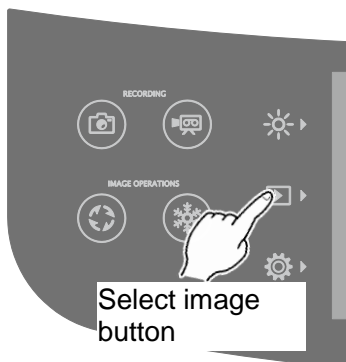

To change the number of thumbnails displayed.

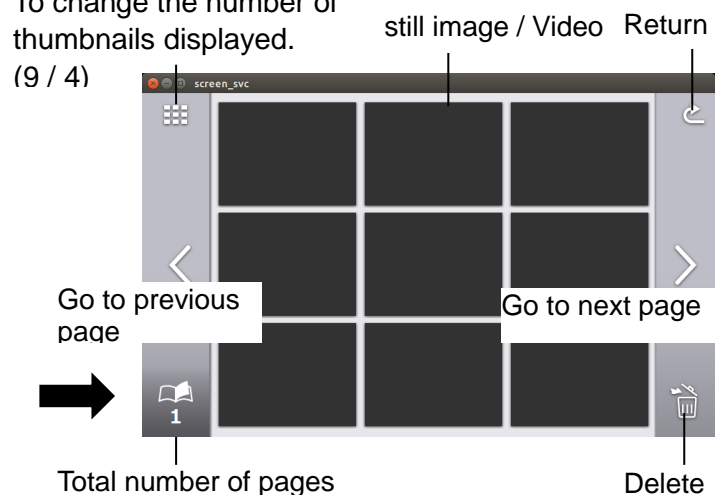

② Select a still image or video that you want to display full-screen.

(1) Tap the thumbnail on the touchscreen to move the cursor.

(2) Tap the selected thumbnail again to display the selected still image or video full-screen. (The video automatically starts to play.)

SD still image / SD video / USB still image (list of thumbnails)

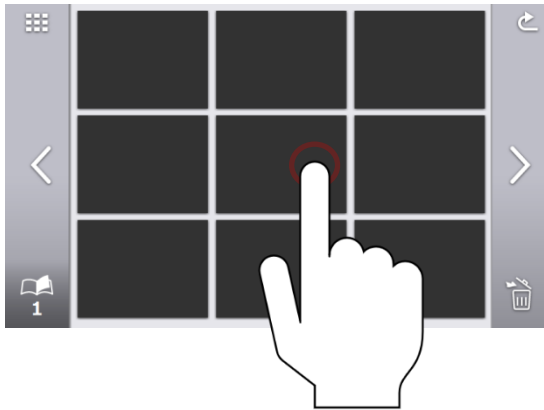

Still image
(⇒P.40)

Video
(⇒P.41)

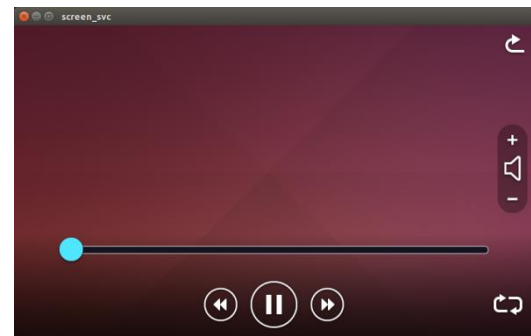
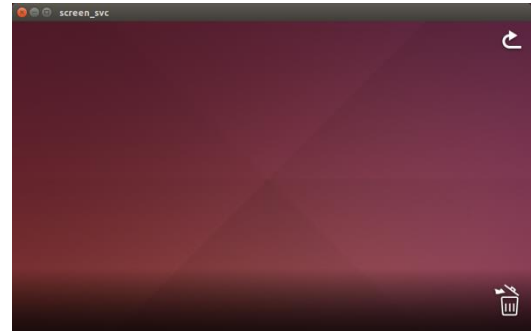

③ Tap the Return icon [] to return to the thumbnail display.

NOTE

Still images taken by third-party devices can be played by the PX-10E/30E using the SD card or USB flash drive.

Supported file format

JPEG (DCF2.0 compliant)

Maximum width of the image: 4,000 pixels

Maximum height of the image: 3,000 pixels

Video files taken by third-party devices cannot be played by the PX-10E/30E using the SD card or USB flash drive.

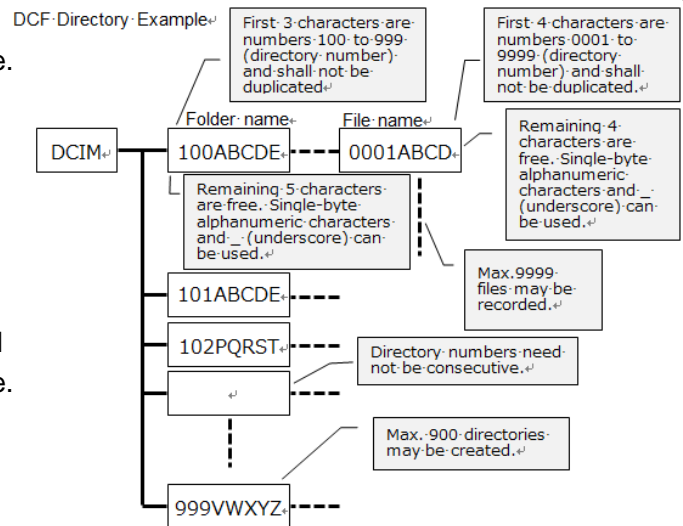

CAUTION

For files that cannot be displayed, an exclamation mark [!] will be displayed on the thumbnail list.



Still images taken by smart devices may not be compliant with DCF standard and will not be displayed on the thumbnail list. Change the file name and folder configuration according to DCF standard to display files on the thumbnail list.

DELETING FILES

Tap the Delete icon [] to enter the File delete mode. (A checkbox appears on the Delete icon in the File delete mode.)

Tap the file to be deleted to put a check mark in the check box. (Multiple files can be selected.)

※Tap the selected file again to deselect it.

※Use [] [] icons to move between pages. It is possible to select or delete files across multiple pages.

Tap the Delete icon again to delete the selected file.

※Tap the Return icon to exit the File delete mode.

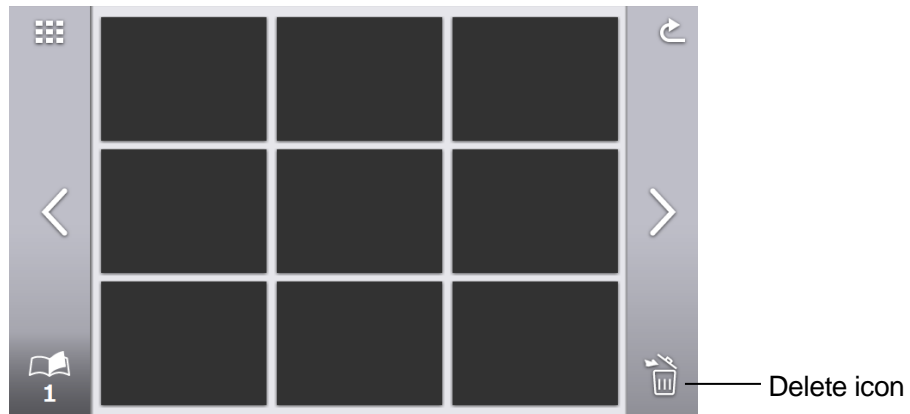

EXPLANATION OF ICONS

SD still image still image / SD video / USB still image (list of thumbnails)

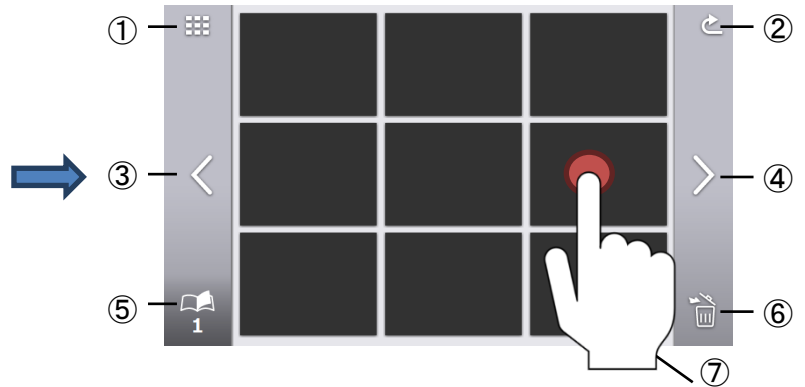
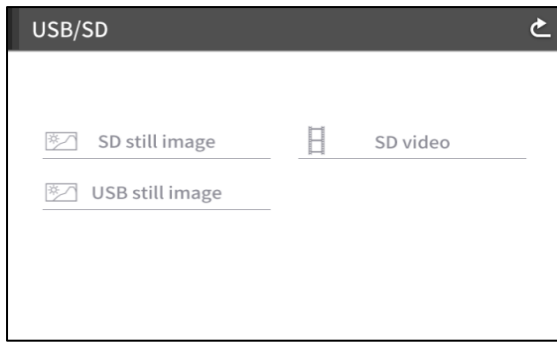

	Icon	Name	Function
①		Number of thumbnails displayed	To change the number of thumbnails displayed. (9 / 4)
②		Return	To return to the [USB/SD] screen.
③		Go to previous page	To move to the previous page.
④		Go to next page	To move to the next page.
⑤		Total number of pages	To display total number of pages in the SD card or USB flash drive.
⑥		Delete all	To delete all the files selected. Tap the Return button to exit the File delete mote. (※It is possible to select files across multiple pages.)
⑦		Select file	To select a video to play or still image to display.

DISPLAYING STILL IMAGE

Tap a thumbnail to display a still image.
Tap the screen to display the menu.

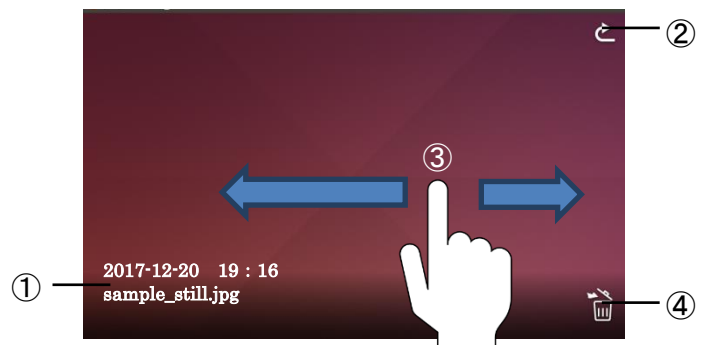

	Icon	Name	Function
①	—	Recorded time and date / File name	To display the recorded time and date, and file name.
②		Return	To return to the [SD still image/ SD video/ USB still image] screen.
③	—	Flick	To move between images. Left flick: move to the previous image Right flick: move to the next image
④		Delete	To delete the displayed still image.

※When any part of the screen outside the menu is tapped while the menu is displayed, the screen returns to the still image screen.

PLAYING VIDEOS







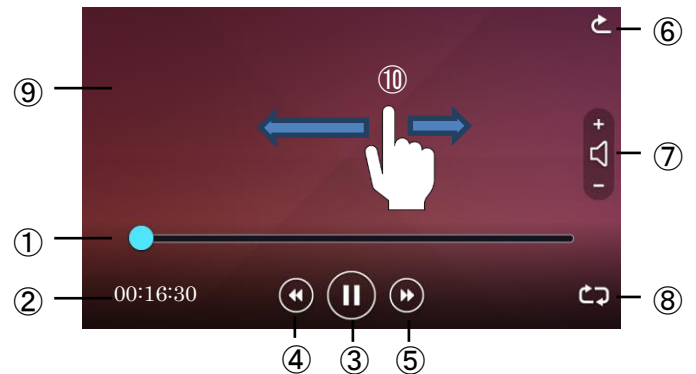

Tap a thumbnail to play a video file.

Tap the Return icon [] to return to the list of thumbnails. You can switch between videos by performing left flick or right flick while the video is playing. (The switched video does not play automatically.)

Left flick: To display the previous video.

Right flick: To display the next video.



	Icon	Name	Function
①		Seek bar	To display the current playback position of the video. The playback position can be shifted by tapping any part of the bar or by sliding the seek bar left and right.
②	—	Playback time	To display playback time.
③		Play / Pause	To pause the played video. This button changes to the Playback button during pause. Tap this button again to restart the video.
④		Go to previous video file	To play previous video.
⑤		Go to next video file	To play next video.
⑥		Return	To return to the [SD video] screen.
⑦		Playback audio	To adjust the playback audio volume using + and -. (0~10: 11 levels)
⑧		Repeat	To automatically replay the video.
⑨	—	Display area	To display the selected video.
⑩		Flick	To switch between videos. Left flick: to display the previous video Right flick: to display the next video

PLAYBACK SPECIFICATIONS (STILL PICTURE / VIDEO)

<STILL IMAGE PLAYBACK>

Media	SD card, USB flash drive, internal memory
Codec	JPEG

<VIDEO PLAYBACK>

Media	SD card (Class 10 or above)
Codec	H.264 / HEVC(H.265)
Container	MP4
Pause	Yes
Playback position	To start video from specific time using the seek bar.
Audio playback	To playback audio by sending audio signals to HDMI and HDBaseT. ※No audio playback from the built-in speaker.

③-2 ABOUT RS-232C

◆ CONNECTION VIA RS-232C

When the RS-232C port is connected to a PC, the PX-10E/30E can be controlled from the PC. When using a commercially available RS-232C cable, make sure that the pins are connected as shown below.

For details of the RS-232C cable, contact the dealer from whom you have purchased the PX-10E/30E or our nearest branch office or sales office.

Applicable lead wire

Single cable: $\Phi 0.32\text{mm} \sim \Phi 0.65\text{mm}$ (AWG28~AWG22)

Stranded cable: $0.08\text{mm}^2 \sim 0.32\text{mm}^2$ (AWG28~AWG22) Strand diameter: more than $\Phi 0.12\text{mm}$

How to connect the lead wire

Press and hold ① with a flat screwdriver. Insert the lead wire into ② firmly. Release the flat screwdriver from ①.

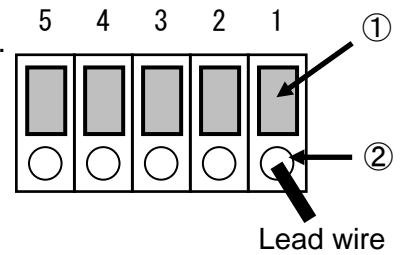

How to disconnect the lead wire

Disconnect the lead wire while pressing ① with a flat screwdriver.

For setting up

To use communication control, be sure to set up in the order described below.

- ① Connect the PX-10E/30E to your PC with the RS-232C cable. [Rear panel: RS-232C port (⇒P.14)]
- ② Start your PC and set the communication mode of the RS-232C to the communication mode of the PX-10E/30E.

NOTE

- To protect the PX-10E /30E and your PC, be sure to turn off the power of each unit before starting the connection work.
- For the information how to set the communication mode of the RS-232C, refer to the instruction manual of your PC.

- ③ Start the program to control the PX-10E/30E from your PC and start the RS-232C control.

RS-232C connector specifications

Pin No	Name
1	CTS←
2	RX←
3	TX→
4	RTS→
5	GND

(←: Reception →: Send)

Transfer of the packet data to the HDBaseT serial port

The packet data that is not for the PX-30E will be transferred to the RS-232C port of the HDBaseT receiver via HDBaseT. With this function, you can control a device connected to the PX-30E with the HDBaseT cable through serial communication remotely.

You can also control the PX-30E from the HDBaseT receiver side through serial communication.

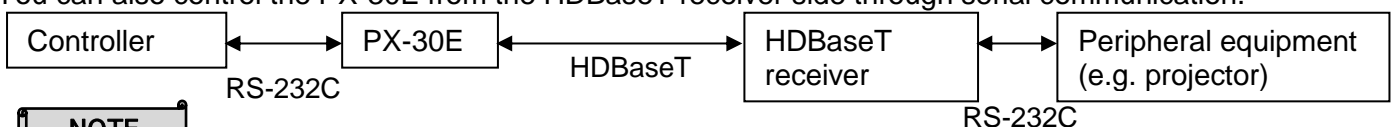

NOTE

- For the information of RS-232C command, etc., contact the dealer from whom you have purchased the PX-10E/30E or our nearest branch office or sales office listed on the supplied Quick Start Guide.

③-3 ABOUT NETWORK FUNCTION (FOR PX-30E ONLY)

By configuring the network settings after connecting the PX-30E to a network device with the LAN cable, you can transmit the setting command from the network device via the network to control the PX-30E.

For details on the setting commands, visit the Elmo official website or contact the dealer from whom you have purchased this product or our branch/office near your location.

<https://www.elmousa.com>

<https://www.elmoeurope.com>

③-4 FIRMWARE UPDATE PROCEDURE

The firmware of the PX-10E/30E will be updated from time to time. By updating the firmware, you will be able to use new functions.

Prepare the firmware and update it according to the instructions below.



For details on the latest firmware, visit the Elmo official website or contact the dealer from whom you have purchased this product or our branch/office near your location.

※Check the firmware version of the PX-10E/30E before starting the firmware update. There is no need to update the firmware if the firmware of the PX-10E/30E is the latest version (⇒P.31)

●Items required for the firmware update

- PX-10E/30E
- The latest firmware
- SD card (to save the firmware)

<Update Procedure>

1. Insert the SD card which contains the copied the firmware for update file into the SD card slot of the PX-10E/30E. (⇒P.15)
2. While pressing the AF button [] and Power button [] on the operating panel together, connect the AC power cord to the PX-10E/30E (Make sure to connect the AC adapter to the wall outlet in advance.)
3. The firmware update starts. (The Power LED flashes green during the update.)
4. Verify that the Power LED flashes blue.
5. Connect the AC power cord and turn on the PX-10E/30E.
6. Initialize the PX-10E/30E. Press the Settings button [] on the operating panel and select "Formatting" in the System Setting menu. (⇒P.29)
The firmware update will be completed when the initialization process is completed.

※The update will be performed automatically regardless of the version of the PX-10E/30E.

※Check whether the firmware has been successfully updated to the latest version by going to "Product Version". (⇒P.31)

③-5 ABOUT EIT(ELMO INTERACTIVE TOOLBOX)

The PX-10E/30E is compatible with the ELMO Interactive Toolbox (EIT) application software. By installing EIT into your PC, you can control a large monitor or tablet PC or annotate on the image using the touchscreen.

The following features are available by connecting a PC with EIT installed to the PX-10E/30E with the USB cable.

- ①Enlarge: You can control the PX-10E/30E or enlarge the PC screen.
 - ②Annotate: You can draw directly on the camera image or on still image or videos in the PC without capturing them.
 - ③Save / playback: You can save the material with annotation to a desired destination.
 - ④Useful functions: sticky notes / trimming / stamps / time-lapse recording
 - ⑤Various tools: various operation modes / compare picture / mask
- ※If EIT is already installed in your PC, you need to update it.

For details on the EIT and how to download the instruction manual of the EIT, visit to the Elmo official website or contact the dealer from whom you have purchased this product or our branch/office near your location.

<https://www.elmousa.com/downloads/>

<https://elmoeurope.com/download/>

③-6 ABOUT SECURITY SLOT

A security slot is provided in the side of the PX-10E/30E. You can connect a security wire to the slot to prevent from theft. Use this feature when you leave the PX-10E/30E in your classroom.

For details of the location of the security slot, refer to “◆PART NAMES” (⇒P.12).

③-7 USING AUTO LOCK

By setting the “Auto lock” in the System Setting menu to ON, you can disable buttons on the operating panel or the LCD touchscreen. Using this feature, you can prevent the miss-operation of the operating panel when touching the object on the stage (e.g. writing on the whiteboard sheet) during the presentation. (⇒P.29)

<How to set Auto lock>

1. Press the Settings button [] on the operating panel. Select “Auto lock” in the System Setting menu and set to ON.
 2. The Auto lock will be activated if no operation of buttons on the operating panel or the LCD touchscreen continues for 30 seconds.
- ※A lock icon will be displayed if buttons on the operating panel are pressed or the LCD touchscreen is touched during Auto lock mode.
- ※The AF button, Power button and Zoom jog dial can be operated even in Auto lock mode.

<How to temporarily cancel Auto lock>

1. Touch and hold the lock icon displayed on the LCD touchscreen.
2. Slide the finger up on the LCD touchscreen.
3. The Auto lock will be temporarily cancelled.

※The Auto lock will be activated again if no operation of buttons on the operating panel or the LCD touchscreen continues for 30 seconds.

<How to cancel Auto lock>

1. Temporarily cancel the Auto lock.
2. Press the Settings button [] on the operating panel. Select “Auto lock” in the System Setting menu and set to OFF.

CAUTION

If the PX-10E/30E is turned off while the Auto lock is ON, the PX-10E/30E will start with the Auto lock ON the next time it is turned on. The Auto lock will be activated if no operation of buttons on the operating panel or the LCD touchscreen continues for 30 seconds.

③-8 USING WOL [WAKE ON LAN] FEATURE (FOR PX-30E ONLY)

By connecting the PX-30E and your PC in the same network using the LAN cable, you can turn on the PX-30E remotely from your PC while the PX-30E is turned off.

You can save time by turning on the PX-30E remotely from your PC before you go to the place where the PX-30E is installed.

Before using WOL, verify the following:

- The PX-30E and your PC are connected to the same network via the LAN cable.
- A communication software which can send WOL commands is installed in your PC.
- The PX-30E is connected to a power source using the AC adapter and AC power cord.
- When the PX-30E was turned off last time, the WOL setting was ON and the PX-30E was turned off either by the Power button or by the remote control or by RS-232C or by network commands.

<How to start the PX-30E using WOL>

1. Start a communication software which can send WOL commands.
2. Enter information such as MAC address to the software. Send commands to start the PX-30E.
3. After receiving the commands, the PX-30E will turn on.

CAUTION

- For details of the communication software, refer to the instruction manual of the communication software.
- It is recommended to set the Auto wake up function to ON when you set the WOL setting to ON.

③-9 USING IN MASS STORAGE MODE

The PX-10E/30E will be recognized as a removable disk when it is connected to a PC via the USB cable in Mass storage mode.

You can view files stored in the PX-10E/30E from a PC using a viewer or transfer them to a PC.

<How to set Mass storage mode>

1. Set the USB mode to "Mass storage" from the System Setting menu. (⇒P.28)
2. Connect the PX-10E/30E and your PC using the USB cable.
3. Files will be displayed automatically on the PC.
4. Open the folder and you will see a list of still images or videos.

Folder structure

```
docom-px
├── PX-xx
│   └── DCIM
│       └── 100_ELMO
```

<How to cancel Mass storage mode>

1. Disconnect the USB cable from the PX-10E/30E.
2. The USB mode will be changed to the UVC mode from the Mass storage mode.

CAUTION

- It is not possible to operate the PX-10E/30E during Mass storage mode.
- It is not possible to save, delete or format the file from a PC.

③-10 Using the MF mode

When the MF mode is set to ON, by rotating the Zoom jog dial on the Operating panel, You can adjust the focus manually.

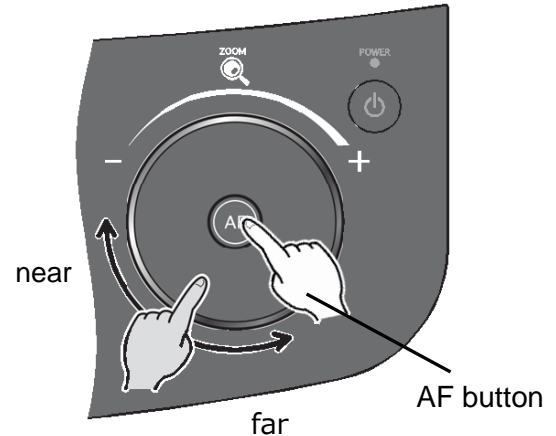

③-11 Using the AV control mode (for PX-30E only)

By connecting the product to a projector with the HDBaseT cable after setting the product to the AV control mode, you can control a projector easily using the LCD touchscreen of the product. (⇒ P.29)

With a single HDBaseT cable you can create a simplified video system with which you can transmit 4K image data (max.70m) and control a projector.

Preparation







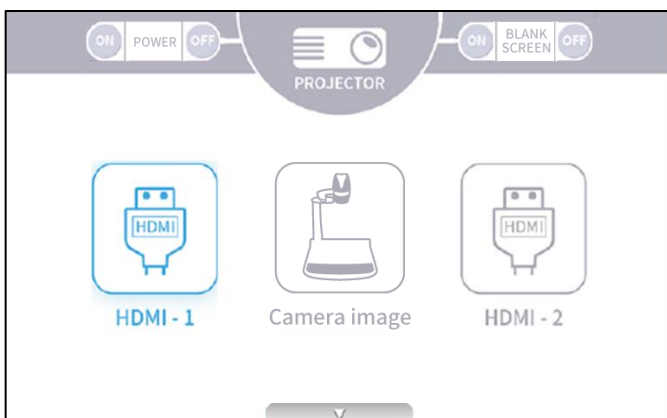

Connect the product to a projector with the HDBaseT cable.

<How to use the AV control mode>

1. Connect the product to a projector with the HDBaseT cable. (⇒P.14)
2. Press the Settings button on the Operating panel and select "AV control mode" in the System Setting menu. (⇒P.29)
3. The AV control menu screen will be displayed.

AV control screen



	Icon	Name	Function
①	 HDMI - 1	HDMI-1	To display the HDMI image being input to the HDMI-1 port.
②	 Camera image	Camera image	To display the camera image.
③	 HDMI - 2	HDMI-2	To display the HDMI image being input to the HDMI-2 port.
④		Power ON	To turn on the connected projector by sending the Power ON command to a projector.
⑤		Power OFF	To turn off the connected projector by sending the Power OFF command to a projector.
⑥		Blank screen ON	To send the Blank screen ON command to a connected projector. The light intensity will be reduced to display the black screen so that the documents will be hidden.
⑦		Blank screen OFF	To send the Blank screen OFF command to a connected projector. The light intensity will be back to normal.
⑧		Screen select	To switch between the Camera / HDMI screen and AV control screen.



4 ERROR MESSAGES



Error message	Possible cause/Countermeasure
SD card is not ready.	The PX-10E/30E failed to start the video recording. Check the followings: (⇒P.15, 34) <ul style="list-style-type: none"> •The SD card is not inserted into the SD card slot. •The SD card is broken. •The remaining capacity of the SD card is insufficient •The SD card is not formatted. (⇒P.29) •The SD card was removed during data saving.
SD card is full. Recording is stopped.	The video recording stopped because there is insufficient free space on the SD card. (A video recording file up to the point the recording is stopped will be created.) Replace the SD card or delete unnecessary files. (⇒P.39)
SD card/USB flash drive is not ready.	The PX-10E/30E failed to capture a still image. Check the followings: <ul style="list-style-type: none"> •The SD card/USB flash drive is broken. •The remaining capacity of the SD card/USB flash drive is insufficient. •The SD card/USB flash drive is not formatted. (⇒P.29) •The SD card/USB flash drive was removed during data saving.
Displaying RGB input	When outputting the image being input to the RGB in port to an external monitor, no image is displayed on the LCD touchscreen. (⇒P.26)
Cannot display images	This message appears when HDCP-protected signals is input to the PX-10E/30E after selecting the HDMI in the Select image menu. (⇒P.26) To display images on the LCD touchscreen, input unencrypted HDMI signals.
Failed to delete file.	The PX-10E/30E failed to delete the file. The thumbnail list screen will be displayed in 2 seconds after this message. Try again from the beginning.
Failed to format.	The PX-10E/30E failed to format the SD card/USB flash drive. Try again from the beginning.

5 TROUBLE SHOOTING

◆ SYMPTOMS AND CONFIRMATION

Check the following items. If any abnormality is found, consult the dealer from whom you purchased the PX-10E/30E or our nearest branch/office.

Symptom	Possible cause/ remedy
No image is displayed.	<ul style="list-style-type: none"> •The cable is not correctly connected. •The AC power cord is disconnected from the wall outlet. •The AC adapter is disconnected from the power inlet of the PX-10E/30E. (⇒P.20) •The power is not on. (Power button: lit in blue) •If you turn on the power immediately after turning it off, the PX-10E/30E may not start. Wait for several seconds after turning the power off, and then turn it back on. •Reconnect the AC power cord. •Zoom is set to the TELE side, displaying only the white or black part of the document. (⇒P.21) •Wrong input source is selected. Set the correct input source from the Select image menu. (⇒P.26) •The output resolution setting of the connected monitor or projector does not match that of the PX-10E/30E. Check the output resolution setting of the monitor or projector. (⇒P.27) •If the image is not displayed on the monitor properly when the resolution setting is set to Auto, change the resolution setting to other than Auto. •The HDMI Input does not support HDCP. No image will be displayed when an HDCP-compatible device is connected.
The recording stops.	<ul style="list-style-type: none"> •If the HDMI cable is disconnected from the monitor or the power of the monitor is turned off during recording when the resolution setting is set to Auto, the PX-10E/30E will recognize that the resolution setting has been changed and the recording will stop. Set the resolution setting to other than Auto to continue the recording.
The output image (resolution) changes automatically.	<ul style="list-style-type: none"> •The resolution setting is set to Auto. When the resolution setting is set to Auto, the output resolution is automatically changed based on the information from the connected device. (⇒P.27)
No image is displayed from the USB port.	<ul style="list-style-type: none"> •No image will be output from the USB port when the USB mode is set to “Mass storage (file transfer)”. Check the USB mode and select “UVC (image output)” from the System Setting. (⇒P.28)
The image is out of focus	<ul style="list-style-type: none"> •The document (subject) is too close to the lens. Move the document (subject) slightly away from the lens.
The image is too dark.	<ul style="list-style-type: none"> •The intensity of the lighting is insufficient. Turn on the LED lighting with the Brightness button in the operating panel or adjust the Iris. (⇒P.24、 P.25) •Press the [ / ] buttons on the remote control to adjust the brightness.
The image is striped.	<ul style="list-style-type: none"> •This may be interference fringes between dots of printed matter and TV scanning lines or CMOS pixels. Changing the shooting range may improve the problem. •Vertical stripes may appear on an LCD projector image. Manually adjusting the dot clock at the projector side may help the problem.

Images on the SD card/USB flash drive are not displayed.	<ul style="list-style-type: none"> Remove the SD card/USB flash drive, wait for a few seconds, and insert again. (⇒P.15)
The image does not move.	<ul style="list-style-type: none"> "Freeze" function is used. Press the Freeze button [] on the operating panel or [] on the remote control to restart the live image feed. (⇒P.13、17)
Not possible to operate with the Remote control.	<ul style="list-style-type: none"> The remaining battery level of the remote control is low. Replace the battery with a new one. Wrong remote control is used. Use the supplied remote control. (⇒P.17)
After inserting the SD card/USB flash drive, operations cannot be performed.	<ul style="list-style-type: none"> The SD card/USB flash drive is not being read correctly. Use the SD card/USB flash drive after formatting it twice as described below. First, format the card using a PC. Then, format the card using the PX-10E/30E. (⇒P.29)
The touchscreen does not work properly.	<ul style="list-style-type: none"> Check that the touch points on the touchscreen are pressed correctly. (⇒P.23)
No audio from the external microphone.	<ul style="list-style-type: none"> The audio volume is too low. Go to the System Setting and adjust the volume (⇒P.28), or adjust the volume of the external microphone. Go to the System Setting and check that " External mic" is selected in the "Sound switch". (⇒P.28)
The network function does not work.	<ul style="list-style-type: none"> Check the network configuration of the PX-30E and the PC to be connected to the PX-30E.
The LAN cable cannot be connected.	<ul style="list-style-type: none"> The LAN port (RJ45) is located on the rear panel of PX-30E. Check that the connector of the LAN cable is properly connected to the LAN port.
The LAN link LED does not light up.	<ul style="list-style-type: none"> Power is not supplied to the PX-30E or to the device connected to the PX-30E. Check that the cable is connected firmly, and then turn on the power. The cable is disconnected. Check the connection between the cable terminals. Wrong cable is used. When a device to be connected to the PX-30E is a PC, "LAN cross cable" is used, and when it is a hub or router, "straight cable" is used.
Cannot connect to the PX-30 from the client.	<ul style="list-style-type: none"> The IP address of the PX-30E has not been designated. Designate the IP address set in the PX-30E. The IP address of the client is not compatible with the network of the PX-30E. To establish the connection from the client to the PX-30E, the network address should be same between the client and the PX-30E. Default setting of the PX-30E : DHCP
The set time will be reset automatically.	<ul style="list-style-type: none"> The clock setting will be reset automatically after a long period of non-operation. Then you will need to perform the clock setting again.
Any changes to the settings will not be saved.	<ul style="list-style-type: none"> Perform the initialization from the System Setting menu and retry.

About the light (LED lighting)

The brightness of the LED lighting will diminish with long-term use. If its brightness has significantly diminished, consult the dealer from whom you purchased PX-10E/30E or our nearest branch/office for replacement (subject to charge).

About long-term usage of this product

Due to the lifetime of its parts, if PX-10E/30E is used for longer than the warranty period, its performance and quality may deteriorate. In this case, we will replace the parts for a charge. Consult the dealer from whom you purchased this PX-10E/30E or our nearest branch/office.

⑥ SPECIFICATIONS

Item	PX-30	PX-10
Image pick-up element	12M Sony	
Effective pixels	3,840x2,160 (16:9) 8.3M 3,520x2,640 (4:3) 9.3M	
Horizontal resolution	1,600TV lines (center)	
Zoom	24x (Optical zoom 12x + Sensor zoom 2x ※) Digital zoom 12x ※ Total zoom 288x (※when output at 1080p)	
Focus mode	AUTO : Zoom sync AF / One-push AF	
Focus range	WIDE : 5cm~∞ TELE : 20cm~∞ (w/o close-up lens)	
Shooting area	430x320mm (Aspect ratio 4:3) (A4 portrait image can be fully captured when output in HDMI.)	
Illumination	1 (LEDx1 + lens)	
Operating buttons	Zoom : Jog dial (Stage) , Zoom head dial (camera head) Button : Power, AF, Brightness, Image rotation, Freeze, Video recording, Still image recording, Settings, Select image Touchscreen operation : Yes	
LCD touchscreen	High image quality (800x480) 5-inch capacitive touchscreen	
HDMI out	HDMI1.4 compliant 1. 3,840x2,160@30fps 2. 1,920x1,080@60fps 3. 1,280x720@60fps ※In special mode, A4 portrait image can be fully captured during HDMI output.	HDMI1.4 compliant 1. 1,920x1,080@60fps 2. 1,280x720@60fps ※In special mode, A4 portrait image can be fully captured during HDMI output.
RGB out	1. 1,920x1,080@60fps 16:9 2. 1,280x720@60fps 16:9	
USB out	USB3.0 compliant UVC (video) compliant (M-JPEG/YUY2) 1. UHD(3,840x2,160 @30fps) 16:9 2. FHD(1,920x1,080 @60fps) 16:9 3. HD(1,280x720 @60fps) 16:9 4. QUXGA(3,200x2,400 @30fps) 4:3 5. UXGA(1,600x1,200 @30fps) 4:3 6. XGA(1,024x768 @30fps) 4:3 7. VGA(640x480 @30fps) 4:3	USB3.0 compliant UVC (video) compliant (M-JPEG/YUY2) 1. FHD(1,920x1,080 @60fps) 16:9 2. HD(1,280x720 @60fps) 16:9 3. UXGA(1,600x1,200 @30fps) 4:3 4. XGA(1,024x768 @30fps) 4:3 5. VGA(640x480 @30fps) 4:3
	※The frame rate varies depending on the environment in use.	
USB port	1. USB Type B (USB3.0) : Video out 2. USB Type A (USB2.0) : USB flash drive & power supply 3. USB Type A (Power) : Power supply (e.g. WHDI)	
Network	RS-232C / USB / Remote control / Network	RS-232C / USB / Remote control

HDBaseT out	1. 3,840×2,160@30fps ※2 2. 1,920×1,080@60fps ※1 3. 1,280×720@60fps ※1 ※1 Extendable up to 100m with the LAN cable ※2 Extendable up to 70m with the LAN cable	—
Input source selection	HDMI : Type A x2 VGA : D-Sub x1 For HDMI, recording is possible, and can be converted and output as RGB or USB. (※For RGB, recording is not possible. It will be output as it is without being converted to other format.) For HDMI, the input signal should be either 1920x1080 @60fps or 1280x720 @60fps.	
Record/playback	Recording media : SD card : USB flash drive : Built-in memory Recording format : Video MP4 (Image: HEVC, H.264/ Audio: AAC) : Still image JPEG Image size: 4K@30,2K@60,2K@30,1K@30 Video recording : Normal recording / Time-lapse recording, Date/time stamps ※For USB flash drive, only Still image can be recorded.	Recording media : SD card : USB flash drive : Built-in memory Recording format : Video MP4 (Image: HEVC, H.264/ Audio: AAC) : Still image JPEG Image size: 2K@60,2K@30,1K@30 Video recording : Normal recording / Time-lapse recording, Date/time stamps ※For USB flash drive, only Still image can be recorded.
Drawing	No ※Possible to draw on the supplied whiteboard sheet directly using a whiteboard marker.	
Audio	Input : External microphone / HDMI audio Output : Line out / HDMI	
Presentation	Image rotation (including 90° rotation) / Freeze / Mask / Black and white	
External control	RS-232C / USB / Remote control / Network	
Dimensions	W297×D482×H478mm (When setup) W297×D482×H133mm (When folded)	
Weight	4.5kg	
Image related functions	White balance / Flicker correction / Brightness adjustment / Contrast adjustment / Noise reduction / Contour correction / Color adjustment / Shading correction / Pixel defect correction / High-quality resizing / Chromatic aberration correction	

■ TRADEMARKS AND LICENSES

ELMO , VISUAL PRESENTER are registered trademarks of Elmo Co., Ltd.

SD, SDHC, SDXC, **SD** logo are trademarks of SD-3C,LLC.

HDMI , **HDMI**™ logo and High-Definition Multimedia interface are trademarks or registered trademarks of HDMI Licensing LLC

HDBaseT and **HDBT** are trademarks of HDBaseT Alliance.

Windows, or names of other Microsoft products are trademarks or registered trademarks of Microsoft Corporation in the United States and other countries.

iPhone, iPad and Macbook are registered trademarks of Apple Inc. in the U.S. and other countries.

Chromebook and Android are trademarks or registered trademarks of Google Inc. in the U.S. and other countries.

All other company/product names described in this manual are trademarks or registered trademarks of their respective companies.

This product is licensed under the AVC Visual Patent Portfolio License (AVC Video) for the personal and non-commercial use of a consumer to

- (i) Play AVC Video that was recorded by a consumer engaged in a personal and a non-commercial activity and/or,
 - (ii) Play AVC Video that was obtained from a video provider licensed from MPEG-LA, LLC.
- Additional information including that relating to promotional and commercial uses may be obtained from MPEG-LA, LLC.

ATTENTION

- Unless used for personal use, it is prohibited by copyright law to record slides, books and photos without the prior consent of copyright holder.
- This product is designed to be used in industrial environment. If it is used in a residential area or in an adjacent area thereto, harmful interference to radio or television reception may occur.
- Repair parts
Repair parts are the items which are needed to maintain product functionality. The holding period of such repair parts is 3 years after the product discontinuation, which is equal to the repair period we will accept.
- Any image, which is obtained by this product, and which can be identified, is considered to be private information. Be forewarned that the person who makes use of such images shall be liable for disclosing of such images.

株式会社エルモ社

〒457-0078

名古屋市南区塩屋町一丁目3番地4

Web : <https://www.elmo.co.jp>

製品のお問い合わせは、下記営業所へ

北海道営業所

〒001-0021 札幌市北区北21条西8丁目3番8号

ボックスビル

TEL.011-738-5811

東北営業所

〒980-0802 仙台市青葉区二日町13番18号ステーションプラザ

ビル4階

TEL.022-266-3255

首都圏営業所

〒108-0073 東京都港区三田3丁目12番16号山光ビル

4階

TEL.03-3453-6471

中日本部営業所

名古屋オフィス

〒457-0078 名古屋市南区塩屋町一丁目3番地4

TEL.052-811-5261

京都オフィス

〒604-8101 京都市中京区柳馬場御池下る柳八幡65

京都朝日ビル10階

TEL.075-744-1360

大阪オフィス

〒550-0014 大阪市西区北堀江3丁目12番23号

三木産業ビル9階

TEL.06-6541-0123

西日本営業所

福岡オフィス

〒812-0039 福岡市博多区冷泉町2番8号朝日プラザ

園2階

TEL.092-281-4131

広島オフィス

〒730-0012 広島県広島市中区上八丁堀4-1

アーバンビューグランドタワー1104号室

TEL.082-221-2801

熊本オフィス

〒861-2104 熊本市東区秋津3丁目11-7

TEL.096-282-8338

OVERSEAS SUBSIDIARY COMPANIES

ELMO USA CORP.

Headquarters

6851 Jericho Turnpike

Suite 145

Syosset, NY 11791

Tel. (516) 501-1400

Fax.(516) 501-0429

E-mail : elmo@elmousa.com

Web : <https://www.elmousa.com/>

ELMO Europe SAS

Headquarters

12 place de la Défense

Maison de la Défense

92974 Paris la Défense Cedex FRANCE

Tel. +33 (0) 1 73 02 67 06

Fax. +33 (0) 1 73 02 67 10

E-mail : info@elmoeurope.com

Web : <https://www.elmoeurope.com/>

German Branch

Hansaallee 201, Haus 1

40549 Düsseldorf Germany

Tel. +49 (0) 211 544756 40

Fax. +49 (0) 211 544756 60

E-mail : info@elmo-germany.de

Web :

<https://www.elmo-germany.de/>

Middle East Branch

5WA-129, Dubai Airport Free Zone,

P.O Box 371556, Dubai,

United Arab Emirates

Tel. +971-(0)4-260-2390

Fax. +971-(0)4-260-2392

Web : <https://www.elmoeurope.com>

ELMO CO., LTD.

1-3-4, Shioya-cho, Minami-ku

Nagoya, 457-0078, Japan