

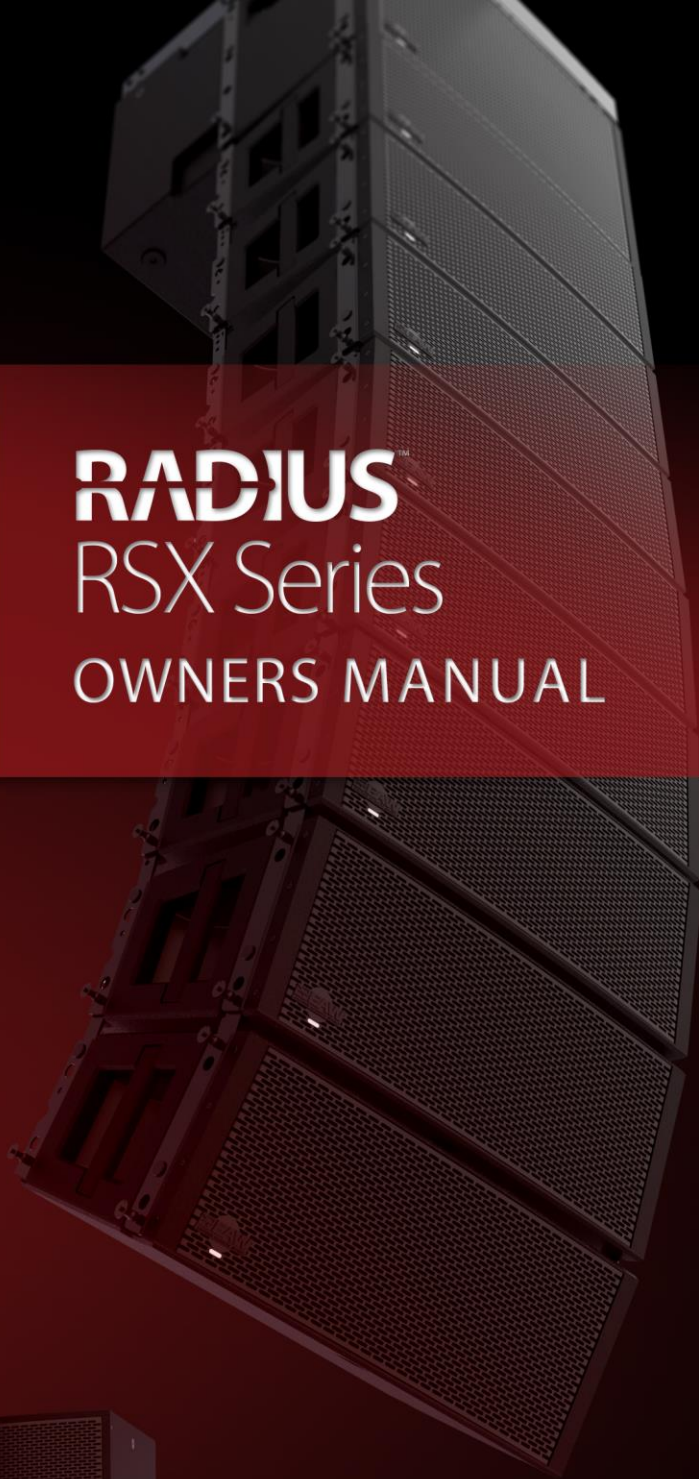

RADIUS™
RSX Series
OWNERS MANUAL



RSX12

Input:
Analog

Voicing:
Sapphire

Level:
0.0 dB

PULL TO OPEN SETTINGS

A Dante™ B

Wi-Fi CONTROL

IMPORTANT SAFETY INSTRUCTIONS – READ THIS FIRST

Safety Instructions

Read and heed all warnings and safety instructions in this manual before using this product. Failure to follow these precautions may result in damage, injury, or death.

- 1) Read these instructions.
- 2) Keep these instructions.
- 3) Heed all warnings.
- 4) Follow all instructions.
- 5) Do not use this apparatus near water.
- 6) Clean only with a dry cloth.
- 7) Do not block any amplifier ventilation openings. Install in accordance with the manufacturer's instructions.
- 8) Do not install near any heat sources such as radiators, heat registers, stoves, or other apparatus that produce heat.
- 9) Do not defeat the safety purpose of the polarized or grounding-type plug. A polarized plug has two blades with one wider than the other. A grounding type plug has two blades and a third grounding prong. The wide blade or the third prong is provided for your safety. If the provided plug does not fit into your outlet, consult an electrician for replacement of the obsolete outlet.
- 10) Protect the power cord from being walked on or pinched particularly at plugs, convenience receptacles, and the point where they exit from the apparatus.
- 11) Only use attachments/accessories specified by the manufacturer.
- 12) Use only with a cart, stand, tripod, bracket, or table specified by the manufacturer, or sold with the apparatus. When a cart is used, use caution when moving the cart/apparatus combination to avoid injury from tip-over. In addition, use only with the Caster Pallets and flybars specified by the manufacturer, or sold with the apparatus. When a Caster Pallet is used, use caution when moving the apparatus combination to avoid injury from tip-over.
- 13) Unplug this apparatus during lightning storms or when unused for long periods of time.
- 14) The AC Mains PowerCon connector (the appliance coupler) is used as the disconnect device. This connector shall remain readily accessible and operable.
- 15) Refer all servicing to qualified service personnel. Servicing is required when the apparatus has been damaged in any way, such as power-supply cord or plug is damaged, liquid has been spilled or objects have fallen into the apparatus, does not operate normally, or has been dropped.



WARNING: To reduce the risk of fire or electric shock, do not expose this apparatus to rain or moisture.

WARNING: If the AC mains connectors on this product are not compatible with the local AC mains receptacle, employ a licensed electrician to provide the proper connector and voltage to interface with the product. Ensure that the AC power supply has a properly grounded safety ground. Failure to follow this warning could cause damage, injury, or death.

CONSIGNES DE SÉCURITÉ – À LIRE EN PREMIER



The lightning flash with arrowhead symbol within an equilateral triangle is intended to alert the user to the presence of uninsulated "dangerous voltage" within the product's enclosure, that may be of significant magnitude to constitute a risk of electric shock to persons.

Instructions Relative à la Sécurité

Lisez et respectez toutes les consignes de sécurité et les mises en garde fournies dans le manuel des enceintes EAW avant d'utiliser ce produit. Le non-respect de ces consignes et mises en garde peut entraîner des dommages aux équipements et des accidents aux personnes pouvant être fatals.

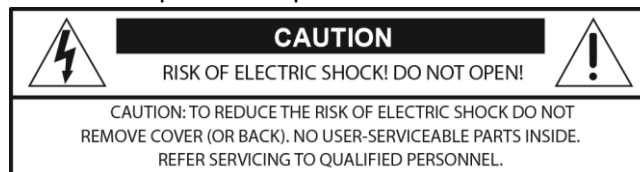

ATTENTION: Si l'alimentation secteur connecteurs sur ce produit ne sont pas compatibles avec l'AC locale secteur Embase, employer un électricien agréé pour fournir le connecteur et la tension appropriée à l'interface avec le produit. Assurez-vous que l'alimentation en courant alternatif a une terre de sécurité à la terre. Le non-respect de cet avertissement peut causer des dommages, des blessures ou la mort.

ATTENTION: Si ce produit contient une batterie au lithium, danger d'explosion si la pile au lithium est remplacée de façon incorrecte. Ne tentez pas de remplacer la batterie vous-même.

PRECAUZIONI DI SICUREZZA - DA LEGGERE PER PRIMO

Norme di Sicurezza

Prima di procedere con l'utilizzo del prodotto, leggere e rispettare ogni avvertenza e norma di sicurezza riportata nel "Manuale EAW Loudspeaker". Il mancato rispetto di ogni precauzione può causare danni all'apparecchiatura, nonché infortuni alle persone o la morte.

ATTENZIONE: Se i connettori di rete AC su questo prodotto non sono compatibili con il CA locale di rete presa, impiegare un elettricista per fornire il connettore corretto e la tensione di interfacciarsi con il prodotto. Assicurarsi che l'alimentazione CA ha una terra di sicurezza a terra. La mancata osservanza di questa indicazione può causare danni, lesioni o morte.

ATTENZIONE: Se questo prodotto contiene una batteria al litio, pericolo di esplosione se la batteria al litio non è sostituita correttamente. Non tentare di sostituire la batteria da soli.

PRECAUCIONES DE SEGURIDAD - LEA EST O PRIMERO

Instrucciones de Seguridad

Lea y observe todos los avisos e instrucciones de seguridad que aparecen en el "Manual de altavoces EAW" adjunto antes de usar este aparato. El no observar esta precaución puede dar lugar a averías en el aparato, daños en las personas o incluso la muerte.

PRECAUCION: Si los conectores de red eléctrica de CA de este producto no son compatibles con el CA local de red receptáculo, emplear un electricista autorizado para proporcionar el conector y el voltaje para interactuar con el producto. Asegúrese de que la fuente de alimentación de CA tiene una conexión a tierra a tierra adecuada. El incumplimiento de esta advertencia podría causar daños, lesiones o muerte.

PRECAUCIÓN: Si este producto contiene una batería de litio, peligro de explosión si la batería de litio se sustituye de forma incorrecta. No intente reemplazar la batería usted mismo.

SICHERHEITSHINWEISE - LESEN SIE DIESEN ABSCHNITT ZUERST

Sicherheitsanweisungen

Lesen und beachten Sie alle Warnungen und Sicherheitsanweisungen der mitgelieferten "EAW Lautsprecher Bedienungsanleitung" vor der Benutzung des Produkts. Nichtbeachtung dieser Hinweise können möglicherweise zu Schäden am Equipment oder zu Verletzungen bzw. zum Tod von Personen führen.

WARNUNG: Wenn die AC-Netzstecker auf diesem Produkt nicht kompatibel sind mit der lokalen Netzsteckdose Netz, verwenden einen Elektrofach den richtigen Anschluss und Spannung als Schnittstelle mit dem Produkt zur Verfügung zu stellen. Stellen Sie sicher, dass die Stromversorgung einwandfrei geerdete Schutzterde hat. Die Nichtbeachtung dieser Warnung kann zu Schäden, Verletzungen oder zum Tod führen.

ACHTUNG: Falls dieses Produkt eine Lithium-Batterie, Explosionsgefahr enthält, wenn Lithium-Batterie falsch eingesetzt wird. Versuchen Sie nicht, die Batterie selbst zu ersetzen.

CAUTION: If this product contains a lithium battery, danger of explosion if lithium battery is incorrectly replaced. Do not attempt to replace the battery yourself. Note: This equipment has been tested and found to comply with the limits for a Class A digital device, pursuant to part 15 of the FCC Rules. These limits are designed to provide reasonable protection against harmful interference when the equipment is operated in a commercial environment. This equipment generates, uses, and can radiate radio frequency energy and, if not installed and used in accordance with the instruction manual, may cause harmful interference to radio communications. Operation of this equipment in a residential area is likely to cause harmful interference in which case the user will be required to correct the interference at his own expense.

CAUTION: Changes or modifications not expressly approved by LOUD Technologies® could void the user's authority to operate the equipment under FCC rules.

Correct Disposal of this Product

This symbol indicates that this product should not be disposed of with your household waste, according to the WEEE Directive (2012/19/EU) and your national law. This product should be handed over to an authorized collection site for recycling waste electrical and electronic equipment (WEEE). Improper handling of this type of waste could have a possible negative impact on the environment and human health due to potentially hazardous substances that are generally associated with WEEE.

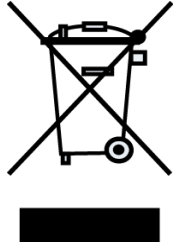

At the same time, your cooperation in the correct disposal of this product will contribute to the effective usage of natural resources. For more information about where you can drop off your waste equipment for recycling, please contact your local city office, waste authority, or your household waste disposal service.

Electrical Warnings

AC Mains Supply

WARNING: Read all instruction and cautionary notes concerning electrical power in this document.

ALIMENTATION SECTEUR

ATTENTION: Lisez toutes les instructions et mises en garde concernant les notes d'énergie électrique dans le présent document.

ALIMENTAZIONE AC

ATTENZIONE: Leggi tutte le note di istruzione e di cautela in materia di energia elettrica in questo documento.

FUENTE DE ALIMENTACIÓN

PRECAUCION: Lee todas las notas de instrucciones y advertencias relativas a la energía eléctrica en este documento.

NETZSTROMVERSORGUNG

WARNUNG: Alle Anweisung und Hinweise bezüglich elektrischer Energie in diesem Dokument.

AC Mains Cable

WARNING: If the AC mains connectors on this product are not compatible with the local AC mains receptacle, employ a licensed electrician to provide the proper connector and voltage to interface with the product. Ensure that the AC power supply has a properly grounded safety ground. Failure to follow this warning could cause damage, injury, or death.

WARNING: Ensure that AC power supply has a properly grounded safety ground. Failure to follow this warning could cause equipment damage, injury, or death.

Cordon secteur

ATTENTION: Il se peut que le format de la fiche secteur ne corresponde pas à celui de votre situation géographique. Dans ce cas, faites appel à un électricien agréé pour qu'il remplace la fiche par une autre du bon format. Respectez les normes électriques de câblage locales.

ATTENTION: Assurez-vous que la ligne secteur dispose d'une terre. Le non-respect de cette précaution peut entraîner des dommages aux équipements et des accidents aux personnes pouvant être fatals.

Cavo d'alimentazione AC

CAUTELA: Il connettore del cavo d'alimentazione AC fornito in dotazione potrebbe non essere adeguato per le prese di corrente impiegate nell'area in cui il diffusore viene utilizzato. In questo caso, contattare un elettricista qualificato per sostituire la presa di corrente con una dotata di connessione adeguata. Per il cablaggio, occorre seguire la codifica corretta utilizzata nell'area d'utilizzo.

ATTENZIONE: Assicurarsi che la presa d'alimentazione sia correttamente collegata a terra. Il mancato rispetto di tali avvertenze potrebbe causare danni all'apparechiatura, nonché infortuni alle persone o la morte.

Cable de alimentación

PRECAUCION: El enchufe que viene en el cable de alimentación incluido puede que no encaje en las salidas de corriente de su zona. Si ocurre esto, contacte con un electricista profesional para que sustituya el enchufe problemático y lo cambie por uno adecuado para la salida de corriente. Compruebe que se sigan todas las normativas de seguridad aplicables.

PRECAUCION: Asegúrese que la fuente de alimentación tenga una conexión a tierra correcta. El no cumplir con esta advertencia puede dar lugar a daños en el equipo, en las personas que lo manejen o incluso la muerte.

Netzkabel

VORSICHT: Das mitgelieferte Netzkabel besitzt möglicherweise einen Netzstecker, der nicht in Ihre Steckdose passt. In diesem Fall können Sie sich von einem zugelassenen Elektrobetrieb einen passenden Netzstecker unter Berücksichtigung der jeweils gültigen Vorschriften montieren lassen.

WARNUNG: Stellen Sie sicher, dass der Schutzleiter der Netzsteckdose eine gute Verbindung zur Erde hat. Nichtbeachtung dieses Hinweises kann zu Schäden am Equipment, zu Verletzungen oder zum Tod führen.

Suspension Warnings

WARNING: Suspending anything, especially overhead of people, should be done with extreme caution. Always engage the services of a certified professional who is qualified to determine the requirements for and to implement overhead rigging. Only persons with the knowledge of proper hardware and safe rigging techniques should attempt to suspend loudspeakers overhead. Failure to follow these precautions may result in damage, injury, or death.

Avertissements de suspension

AVERTISSEMENT: Suspendre quoi que ce soit, en particulier les frais généraux de personnes, doit être fait avec une extrême prudence. Toujours engager les services d'un professionnel certifié qui est qualifié pour déterminer les conditions requises et à mettre en œuvre le gréement en tête. Seules les personnes ayant la connaissance du matériel approprié et les techniques sécuritaires de gréage devraient tenter de suspendre les haut-parleurs au-dessus. Le non-respect de ces précautions peut entraîner des dommages, des blessures ou la mort.

Avvertenze sospensione

AVVERTENZA: Sospendere nulla, soprattutto sovraccarico di persone, deve essere fatto con estrema cautela. Inserire sempre i servizi di un professionista certificato che si è qualificato per determinare i requisiti di e ad attuare manovre in testa. Solo le persone con la conoscenza di tecniche di assemblaggio di sicurezza hardware e dovrebbero tentare di sospendere gli altoparlanti in testa. La mancata osservanza di queste precauzioni può provocare danni, lesioni o morte.

Advertencias de suspensión

ADVERTENCIA: La suspensión de cualquier cosa, especialmente por encima de las personas, se debe hacer con mucho cuidado. Siempre contratar los servicios de un profesional certificado que está calificado para determinar los requisitos para implementar y para las maniobras de elevación. Sólo las personas con el conocimiento de las técnicas de aparejo de seguridad de hardware adecuada y deben intentar suspender altavoces por encima. El incumplimiento de estas precauciones puede resultar en daños, lesiones o muerte.

Suspension Warnungen

WARNUNG: Schwebend alles, vor allem Aufwand von Menschen, sollte mit äußerster Vorsicht erfolgen. Immer engagieren, die Dienste eines zertifizierten Profi, der qualifiziert ist, die Anforderungen zu bestimmen und Überkopfmontage zu implementieren. Nur Personen mit der Kenntnis der richtigen Hardware und sichere Rigging Techniken sollten Lautsprecher Kopf auszusetzen versuchen. Die Nichtbeachtung dieser Vorsichtsmaßnahmen kann zu Schäden, Verletzungen oder zum Tod führen.

Table of Contents

IMPORTANT SAFETY INSTRUCTIONS – READ THIS FIRST	3
CONSIGNES DE SÉCURITÉ – À LIRE EN PREMIER.....	3
PRECAUZIONI DI SICUREZZA - DA LEGGERE PER PRIMO	4
PRECAUCIONES DE SEGURIDAD - LEA EST O PRIMERO.....	4
SICHERHEITSHINWEISE - LESEN SIE DIESEN ABSCHNITT ZUERST.....	4
Electrical Warnings.....	5
AC Mains Supply.....	5
ALIMENTATION SECTEUR.....	5
ALIMENTAZIONE AC	5
FUENTE DE ALIMENTACIÓN	5
NETZSTROMVERSORGUNG	5
AC Mains Cable.....	5
Cordon secteur	5
Cavo d'alimentazione AC.....	6
Cable de alimentación.....	6
Netzkabel.....	6
Suspension Warnings	6
Table of Contents	8
RADIUS Series Introduction.....	11
Functionality and Operation.....	12
RSX208L / RSX86 / SX89 / RSX126 / RSX129 / RSX12M Connectors and Controls.....	12
RSX12 / RSX18 / RSX218 Connectors and Controls.....	12
AC Mains Connection	13
Linking power	13
Comm	13
Audio Connections	13
Dante A / B	14
DSP Navigation / Edit Wheel	14
LCD UI Display.....	14
Front Panel LED	14
RSX208L / RSX12 Walkaround	15
Infrared (IR) Transceivers [RSX208L / RSX12].....	15
Rigging Assemblies / Rigging Pins [RSX208L / RSX12].....	15
RSX86 / RSX89 / RSX126 / RSX129 / RSX18 / RSX218 / RSX12M Walkaround.....	16
Mounting Points (aka Fly Points and/or Rigging Points).....	18
Handles.....	18
Pole Cup.....	18
Rear Panel Home Screen and Menu Navigation.....	20
Radius RSX208L Menus.....	20

Level	20
OptiLogic.....	20
Voicing.....	21
Delay.....	22
Output Check.....	23
Settings.....	23
Radius RSX208L Home Screen	24
Radius RSX12 Menus.....	26
Level	26
Crossover.....	26
Delay.....	26
Output Check.....	26
Settings.....	27
Radius RSX12 Home Screen.....	28
Radius RSX86 / RSX89 / RSX126 / RSX129 / RSX12M Menus.....	29
Level	29
Voicing.....	29
Crossover.....	31
Delay.....	31
Output Check.....	31
Settings.....	32
Radius RSX86 / RSX89 / RSX126 / RSX129 / RSX12M Home Screen	33
Radius RSX18 / RSX218 Menus.....	34
Level	34
Crossover.....	34
Cardioid	34
Delay.....	34
Output Check.....	34
Settings.....	35
Radius RSX18 / RSX218 Home Screen	36
In DepthWith Dante™	37
Introduction	37
Why use Dante?.....	37
Using a Wi-Fi Router with EAWmosaic.....	37
Mastering EAWmosaic.....	38
Introduction	38
What is EAWmosaic?	38
Why use EAWmosaic?	38
How does EAWmosaic work?.....	38
Device and Download Requirements.....	39

Array Quick-Start Guide	40
Troubleshooting	45
Service, Inspection & Maintenance.....	46

RADIUS Series Introduction

Congratulations on your purchase of an EAW RADIUS loudspeaker. With proper operation and care, this EAW product will provide many years of service and reliability.

In addition to offering renowned EAW fidelity at any output level, we are confident that RADIUS will drastically change the way you use your sound system, saving you time, effort, money and frustration and delivering superior results. The below chart contrasts the process of getting RADIUS show-ready in comparison to a 'conventional' sound system, illustrating the tremendous time savings and simplification, whether for permanent installation or portable applications.

Step	Conventional Sound System	RADIUS
1	Bring equipment into space.	Bring equipment into space.
2	Connect audio cabling.	Connect power and network.
3	Verify each loudspeaker works and that cabling is not faulty (level shift or polarity inversion).	Not necessary.
4	Troubleshoot any issues found in step #3.	
5	Set up measurement system.	
6	Take measurements of system. Equalize. Repeat until system is 'tuned'.	Open Mosaic. Detect system online, select voicing and run OptiLogic. Make any adjustments to taste.
7	Use system.	Use system.

This document provides basic guidance and operating instructions for using the system. The user is encouraged to utilize EAWmosaic and Resolution to explore the range of possibilities that RADIUS can provide for their application. Additionally, this manual and the EAWmosaic Help File are frequently updated with new and beneficial information, so check back often.

Enjoy the use of your RADIUS system!

Functionality and Operation

RSX208L / RSX86 / SX89 / RSX126 / RSX129 / RSX12M Connectors and Controls

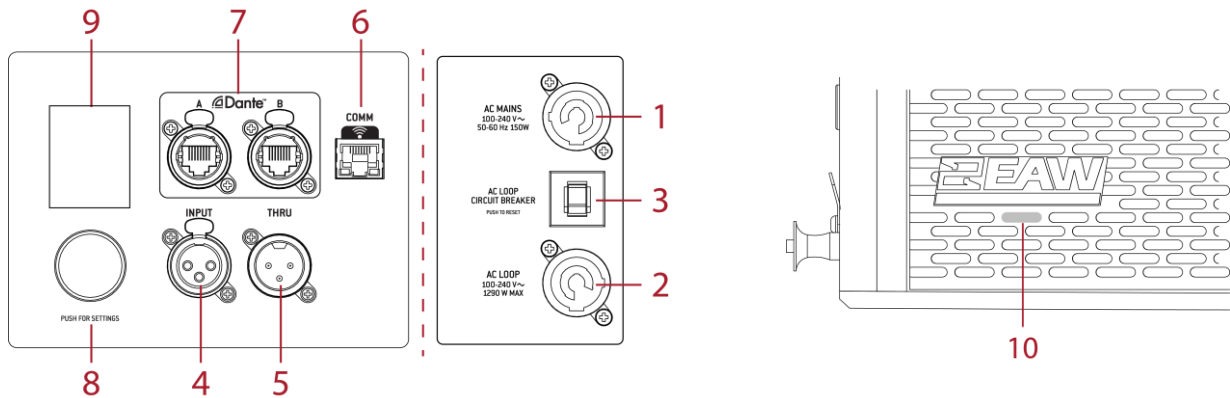

- | | |
|---|---|
| <ul style="list-style-type: none"> 1 AC Mains Input 2 AC Mains Loop Through 3 AC Loop Circuit Breaker 4 XLR Input 5 XLR Thru 6 Comm 7 Dante A / B 8 DSP Navigation / Edit Wheel 9 LCD UI Display 10 Front Panel LED | <p>Connect to AC mains supply as labeled.</p> <p>Loop AC Mains for additional RADIUS products.
User Resettable, 12A (115 V), 6A (230 V).</p> <p>Connect Analog input signals.
Loop input signal to additional RADIUS products, or other devices.</p> <p>Enables wireless control.</p> <p>Dual etherCON™ Connectors.
Navigate, edit and select parameters.
Displays the current UI information.</p> <p>Power Indicator / Status.</p> |
|---|---|

RSX12 / RSX18 / RSX218 Connectors and Controls

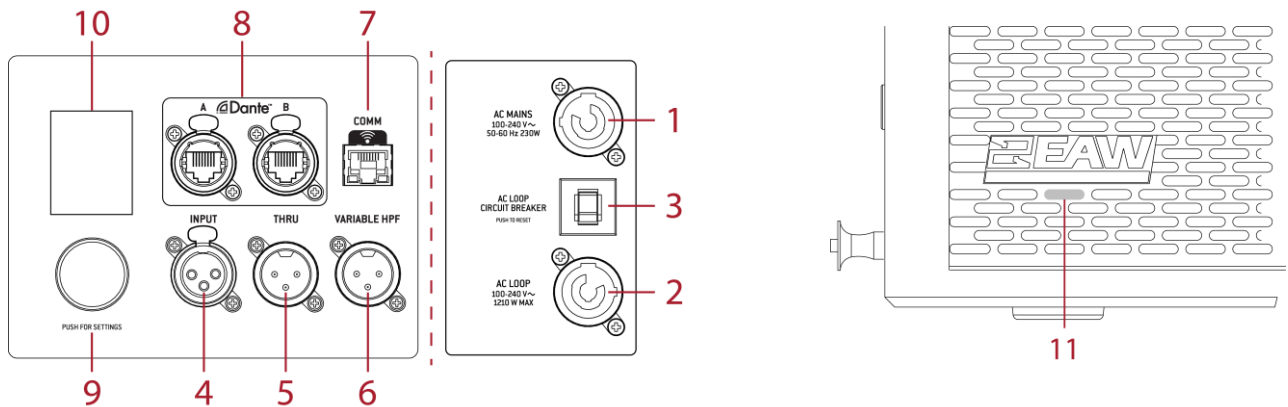

- | | |
|---|---|
| <ul style="list-style-type: none"> 1 AC Mains Input 2 AC Mains Loop Through 3 AC Loop Circuit Breaker 4 XLR Input 5 XLR Thru 6 XLR Variable HPF 7 Comm 8 Dante A / B 9 DSP Navigation / Edit Wheel 10 LCD UI Display 11 Front Panel LED | <p>Connect to AC mains supply as labeled.</p> <p>Loop AC Mains for additional RADIUS products.
User Resettable, 12A (115 V), 6A (230 V).</p> <p>Connect Analog input signals.
Loop input signal to additional RADIUS products, or other devices.</p> <p>Enables wireless control.</p> <p>Dual etherCON™ Connectors.
Navigate, edit and select parameters.
Displays the current UI information.</p> <p>Power Indicator / Status.</p> |
|---|---|

AC Mains Connection

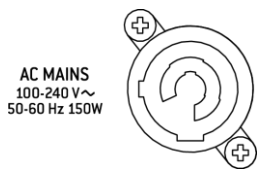

Connect the supplied AC mains cord to the Neutrik powerCON® socket on the rear of the RADIUS. The powerCON® system utilizes a locking connector. To lock, twist 1/4 turn clockwise after fully inserting it into the AC MAINS receptacle. Connect the other end to an AC mains supply receptacle, nominally 115 V 60 Hz or 230 V 50 Hz as labeled on the RADIUS. If necessary, have a qualified electrician change the cable plug as required for compatibility with the local AC mains receptacle.

WARNING: Before connecting a RADIUS to the AC mains supply, completely turn down the input signal using the input level attenuator. If not, there could be excessive and possibly damaging sound levels from the loudspeaker when energized.

There is no power switch on RADIUS. When connected to the AC mains, the loudspeaker will be fully operational, with the output level controlled by the signal source feeding it.

Linking power

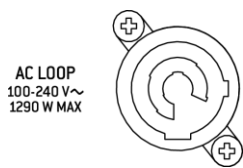

The Neutrik powerCON® AC mains and AC loop connectors are wired in parallel to provide an AC mains inlet and outlet on each RADIUS. The blue AC mains inlet mates with a Neutrik powerCON® NACFC3A (supplied). The white AC mains outlet mates with a Neutrik. Therefore, to loop the AC mains from enclosure to enclosure, connect an AC mains jumper cable as shown (jumper is not included with RADIUS).

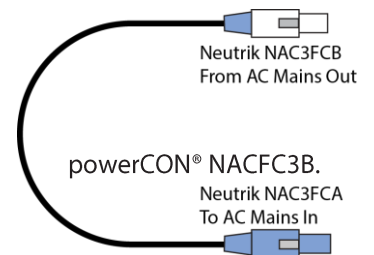

Up to three additional RSX208L's or RSX12's may be looped in this fashion at normal listening level (two at maximum listening level). Up to two additional RSX18's or RSX218's may be looped in this fashion at normal listening level (one at maximum listening level). Up to five additional RSX86's, RSX89's, RSX126's, RSX129's or RSX12M's may be looped in this fashion at normal listening level (four at maximum listening level). Use an AC loop connector to daisy-chain AC mains power from one enclosure to another. The maximum continuous load must not exceed 12A for the 115V version and 6A for the 230V version.

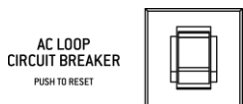

NOTE: The circuit breaker only protects the AC loop outlet, not the AC mains connector. If the continuous load connected to the AC loop outlet exceeds the rated load, the circuit breaker will trip. For this situation, reduce the connected load and then manually reset the circuit breaker.

Comm

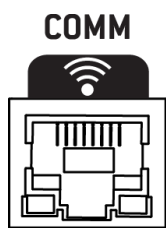

The purpose in life of this 100 Mb network connector is to connect RADIUS to a Wi-Fi router via CAT5 (or better) Ethernet cable, thus enabling wireless control.

Plug one end of the Ethernet cable into the RADIUS network connector and the other end of the Ethernet cable into a LAN port on the router, NOT a WAN port. Most routers allow the use of either a straight-wired cable or crossover cable, but if you have a choice, a straight-wired Ethernet cable is the way to go to ensure smooth operation with any router.



If needed, complete directions for setting up the router may be found in the [EAWmosaic Help File](#)

Audio Connections

Analog Audio

Connect the output from your line-level signal source to the XLR-3F INPUT connector on the rear panel. This is an electronically balanced input. Users must provide their own XLR cables. The XLR-type connectors on the rear of each RADIUS are designed for professional audio signal levels, nominally 0 dBu (= 0.775 V). Normally, use the female XLR as the signal input. Use a male XLR as a loop-thru output to connect the same signal input to an additional RADIUS*.

The wiring convention is as follows:

- Pin 1: Shield
- Pin 2: + / Hot
- Pin 3: - / Cold

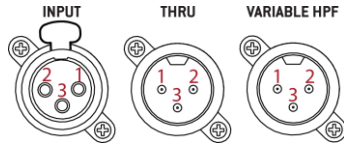

*Typically, a RADIUS array or full-range loudspeaker is connected to the VARIABLE HPF output of a RADIUS subwoofer to “split” the work. The subwoofer handles all of the low frequencies and the array | loudspeaker handles the rest. As a result, it is more efficient and a bit louder.

Dante A / B

Digital Audio

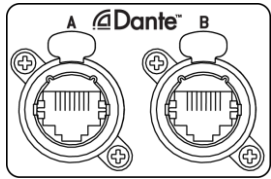

These Dante ports are for connecting one RADIUS to another RADIUS (or another Dante-enabled device) via CAT5 (or better) Ethernet cable. This features dual Dante ports for daisy chaining.

DSP Navigation / Edit Wheel

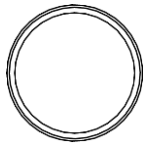

PUSH FOR SETTINGS

Rotate (or push-click) the encoder to open settings, navigate the user interface and edit parameters and select values.

This endless rotary wheel allows you to navigate the user interface, edit sections of RADIUS and navigate within screens to select sub-menus, pages and parameters, as well as select values during editing.

LCD UI Display

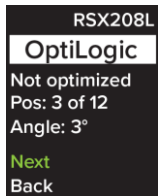

The LCD UI Display is one of the most vital features of RADIUS as it displays all of the menu navigation information. When RADIUS is powered on, it will load up the last state it was in when powered off.

Front Panel LED

The front panel LED illuminates when the AC Mains In of RADIUS is plugged into a suitable AC powersupply. The color of the LED, however, is dependent on the current state of the RADIUS.

These LEDs vary slightly depending on whether EAWmosaic is being used or not. In this case, we’re looking at the hardware only, so NO EAWmosaic. See below:

MODE	BOOT	NORMAL	LIMITING	FAULT	ADVERTISE	IDENTIFY
OFF	OFF	OFF	OFF	OFF	AMBER	WHITE

As seen above, the front panel LED only illuminates in ‘Advertise’ or ‘Identify’.

Advertise is engaged when a speaker is selected in the discovery shelf in EAWmosaic. This enables you to see the speaker that’s been selected, identify it and drag it into the appropriate group. The amber color of the LED makes it clear that it is not yet in the rig and still under EAWmosaic control. Once identified, the LED will turn white.

This is a manual process that can only occur when in setup mode, NOT show mode. An overview of EAWmosaic is explained later in this manual. There is even greater detail in the [EAWmosaic Help File](#).

RSX208L / RSX12 Walkaround

Let's walk around the boxes and take a look at some of the other features of RADIUS.

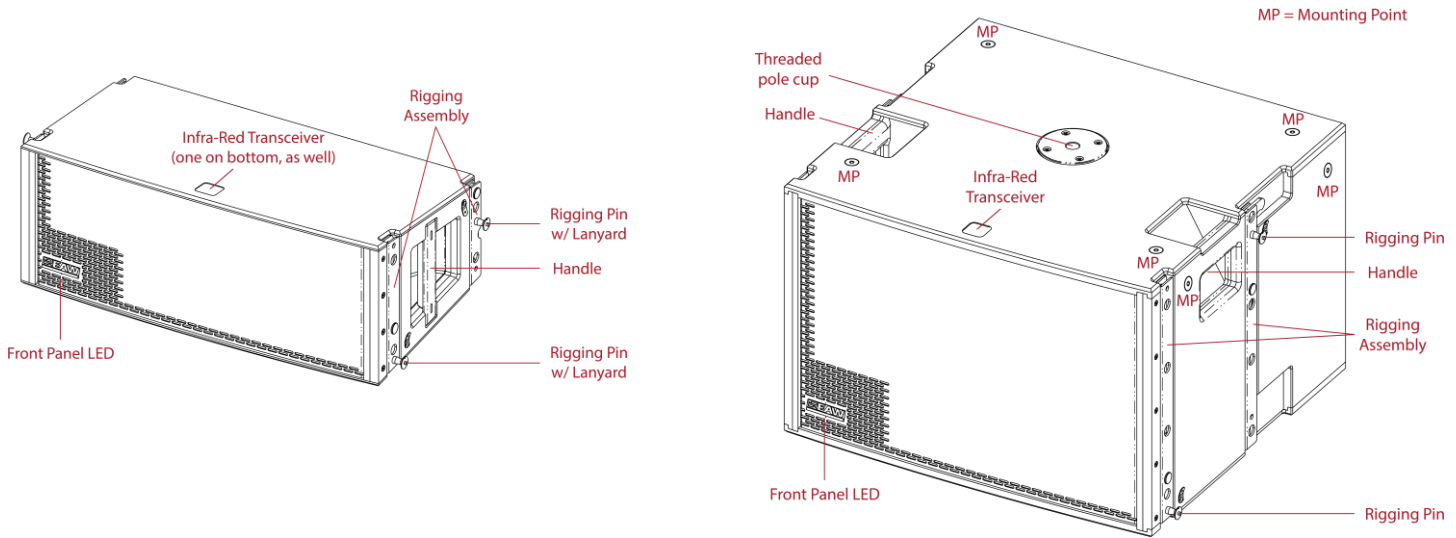

Infrared (IR) Transceivers [RSX208L / RSX12]

Each time a user powers on a RADIUS, the modules immediately use the IR transceivers to announce themselves to their neighbors and recognize the announcements of their neighbors. RADIUS recognizes each individually and as a whole and presents that to EAWmosaic. Users never need to struggle to identify specific modules. The user only needs to identify where each RADIUS is located within the venue (left, right, etc.). The system will determine which modules are within each array, how that array is configured and their position in the array stack.

 The RSX208L has two IR Transceivers; one on the top of the array and one on the bottom of the array. The RSX12, however, only has one IR Transceiver, located on the top of the box.

Rigging Assemblies / Rigging Pins [RSX208L / RSX12]

Every RSX208L and RSX12 comes with Rigging Assemblies with two connected Rigging Pins on each side, four total.

 The RSX208L Rigging Pins come equipped with lanyards. Additionally, the RSX208L ships with two extra Rigging Pins and lanyards, although these will need to be connected first, if used.

NOTE: The integral mounting points on the RSX12 enclosure are designed to support only a single enclosure. ALWAYS SUSPEND ENCLOSURES VIA EYEBOLTS DIRECTLY FROM THE STRUCTURE. NEVER SUSPEND ENCLOSURES FROM OTHER ENCLOSURES VIA EYEBOLTS. The only exception to this is utilizing a flybar and the integral array rigging on the RSX208L or RSX12.

Always use EAWmosaic or EAW Resolution to verify the structural integrity of the array you intend to suspend. The ONLY exception to this is with the pre-defined, pre-approved array configurations provided later in this manual.

RSX86 / RSX89 / RSX126 / RSX129 / RSX18 / RSX218 / RSX12M Walkaround

Let's walk around the other RADIUS Series boxes and take a look at the remaining features of all models.

MP = Mounting Point

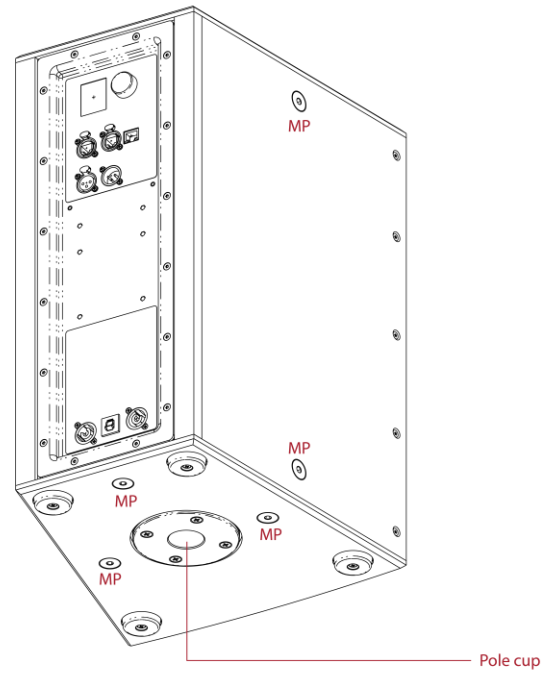
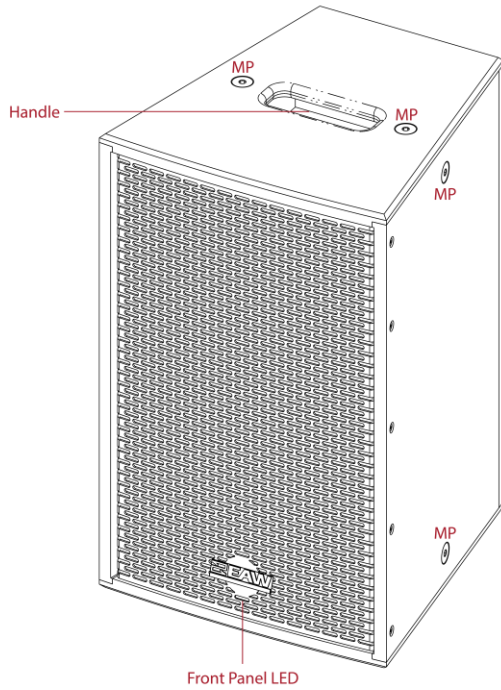

MP = Mounting Point

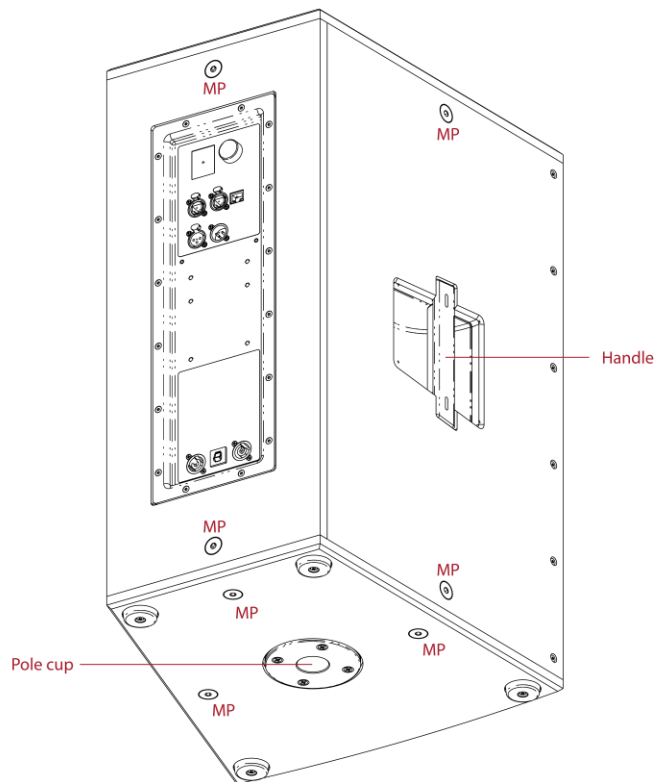
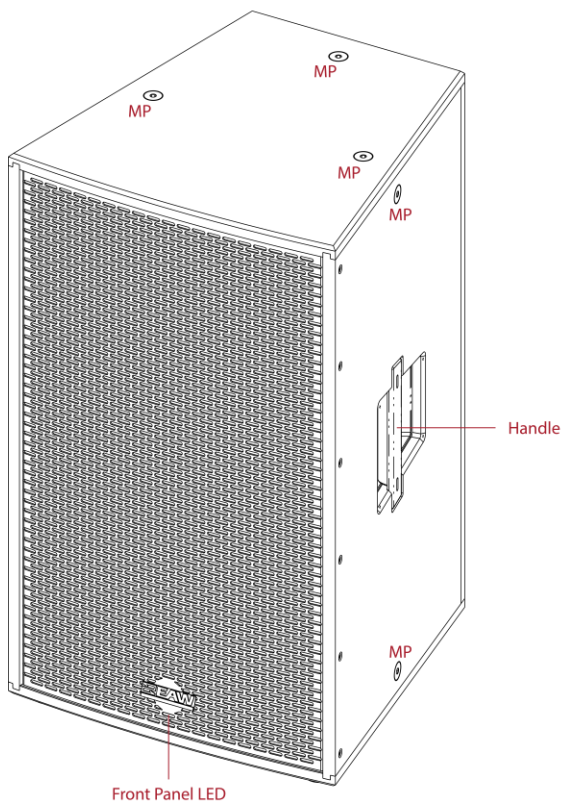

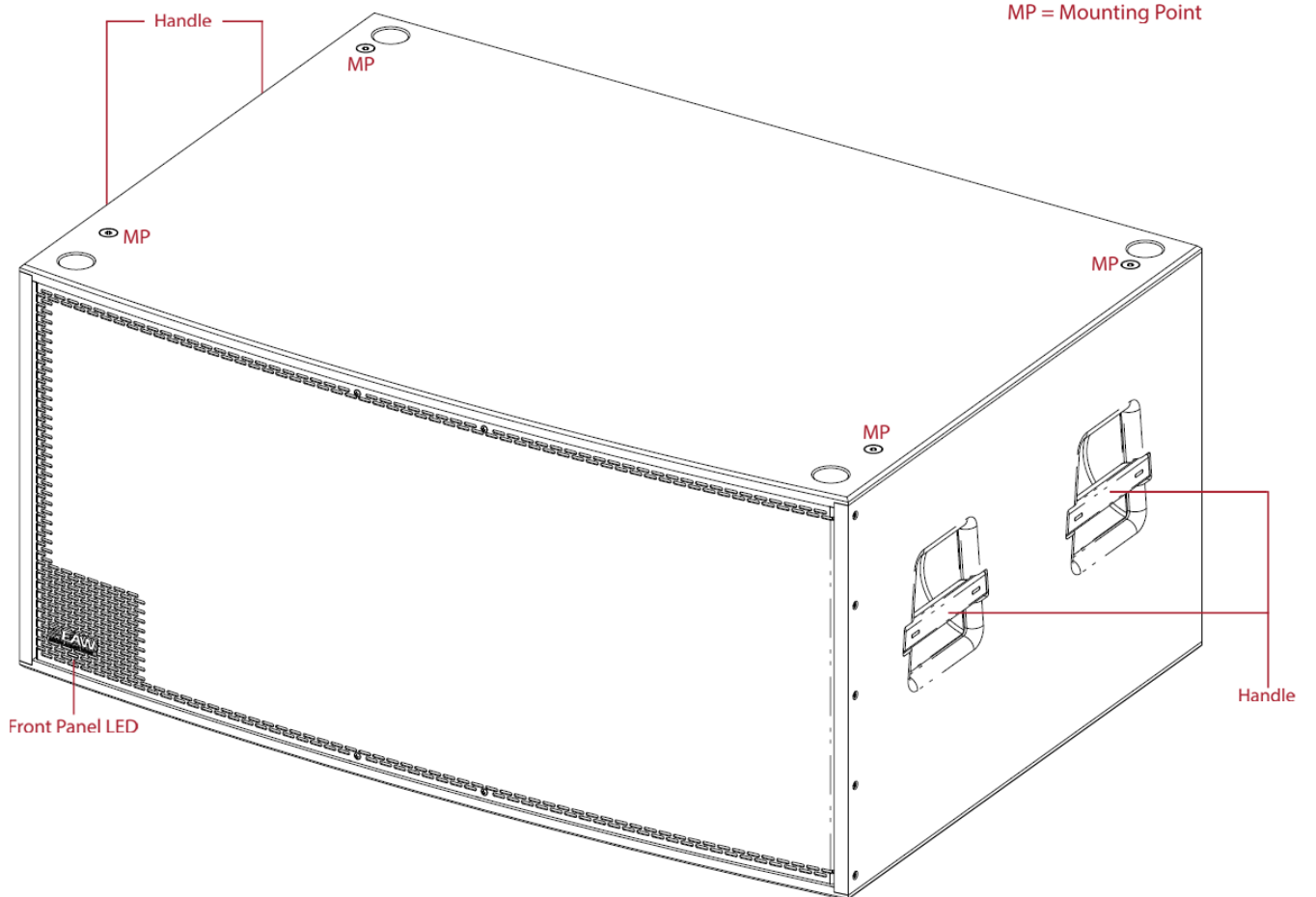
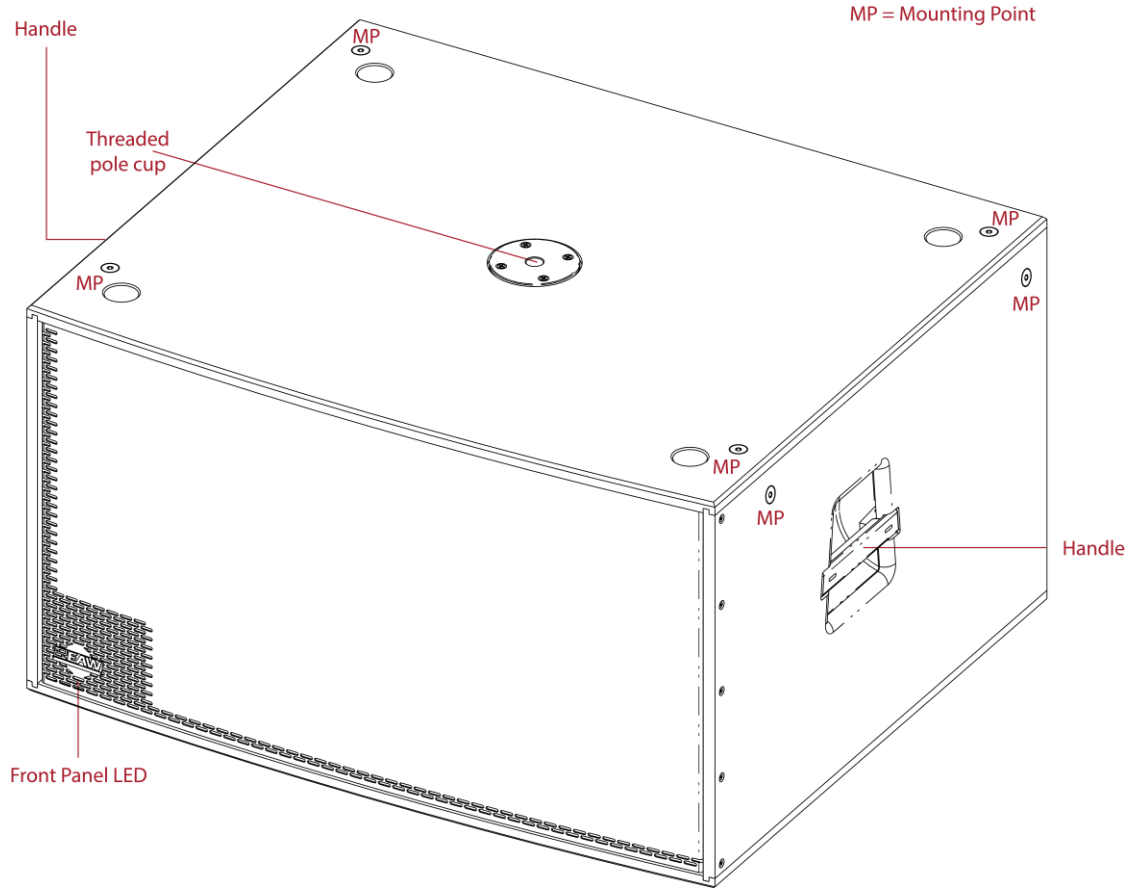

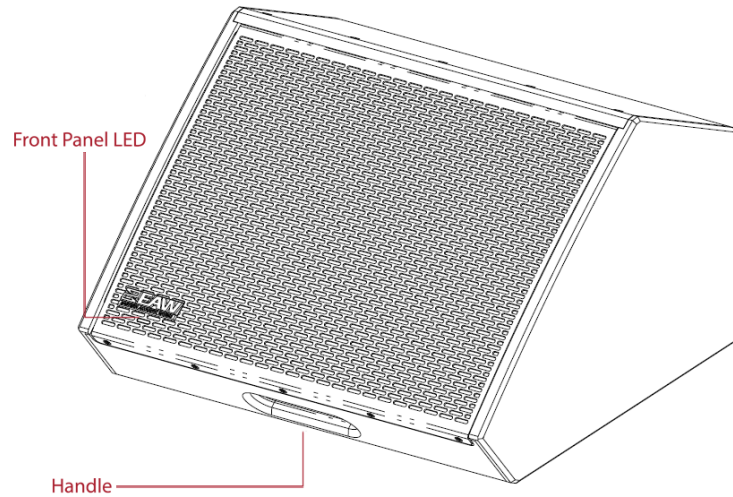

Mounting Points (aka Fly Points and/or Rigging Points)

As seen in the images above, the RADIUS RSX12 and RSX18 subwoofers come equipped with eight (8) integrated mounting points. Four are located in each corner on the top of the box and two are on the top corner of each side. The RADIUS RSX218 subwoofer comes equipped with four (4) integrated mounting points located in each corner on the top of the cabinet. The RADIUS RSX86 and RSX89 full-range loudspeakers come equipped with nine (9) integrated mounting points. Two are located on either side of the top handle, two are on each side and three are on the bottom of the unit. The RADIUS RSX126 and RSX129 full-range loudspeakers come equipped with nine (12) integrated mounting points. Three are located on the top of the box, two are on each side, three are on the bottom and two are on the rear panel of the unit.

For RSX12x and RSX8x, always utilize at least two mounting points for suspension. For the RSX18 and RSX218, always utilize at least four mounting points.

NOTE: The integral mounting points on the enclosure are designed to support only a single enclosure. ALWAYS SUSPEND ENCLOSURES VIA EYEBOLTS DIRECTLY FROM THE STRUCTURE. NEVER SUSPEND ENCLOSURES FROM OTHER ENCLOSURES VIA EYEBOLTS.

 The RSX208L has no mounting points. It is, though, suitable for rigging using the optional FBX100 Flybar and attached rigging assemblies.

Handles

The built-in handles on all RADIUS boxes – except the RSX86, RSX89, and RSX12M – indicate that they should always be lifted, carried and moved by at least two people regardless of how strong you think you are.

 NEVER attempt to suspend ANY RADIUS box by its handles. Failure to follow these precautions may result in damage to the equipment, personal injury, or death.

Pole Cup

All RADIUS Series models – except the RSX208L, RSX218 and RSX12M – have a built-in pole cup. The pole cups on the RSX12 and RSX18 subwoofers are threaded for extra security. Be sure to tighten the pole to the subwoofer before placing a full-range loudspeaker on top of the pole. The RSP-1 and RSP-2 are both great options.

 Check to make sure that the support surface (e.g. floor, etc.) has the necessary mechanical characteristics to support the weight of the subwoofer(s) and loudspeaker(s). Failure to follow these precautions may result in damage to the equipment, personal injury, or death.

Rear Panel Home Screen and Menu Navigation

The RADIUS Series Loudspeaker's LCD Display and DSP Navigation / Edit Wheel are used to monitor the loudspeaker's status and adjust its DSP settings. Rotate the DSP Navigation / Edit Wheel to change the highlighted sub-menu or to change parameter values. Press it to select a sub-menu or to enter values.

Radius RSX208L Menu

Upon power on and initialization of the loudspeaker the Main Menu is displayed. Here the user can adjust the RSX208L's output level, alignment delay settings, voicing profile and user preferences, initiate a test of the loudspeaker's output and run the Automatic Array Optimization sequence.

If the Home Screen (see below) is displayed, pressing or turning the DSP Navigation / Edit Wheel reveals the Main Menu.

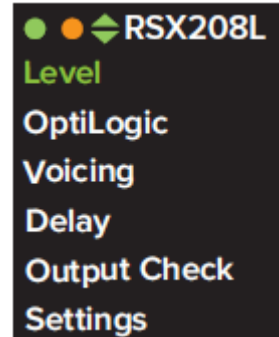

Level

Selecting Level allows the user to adjust the loudspeaker's output level in 0.5 dB increments ranging from -10 dB to +10 dB. Rotating the DSP Navigation / Edit Wheel changes the level value and pressing it returns to the Main Menu. After 5 seconds have passed with no change to the Level parameter the Home Screen is displayed.

OptiLogic

The RSX208L features Automatic Array Detection & Optimization that makes it easier and faster to sound better. The user enters a few parameters - minimum and maximum audience distances and array height - then initiates the optimization sequence. Using integrated infrared transceivers and tilt sensors, the position and splay angle of each RSX208L module within the array is automatically detected. The modules are grouped accordingly and the system's acoustical output is optimized to compensate for array size, audience geometry and throw distance. Array Optimization can be used with or without a network or software application.

From any RSX208L within the array, select the OptiLogic sub-menu to show the current status of the RSX208L within the array. If the array has not already been optimized, or if the array has changed since it was last optimized, the display will indicate "Not optimized". The position of the speaker within the array is indicated. The speaker's splay angle relative to the speaker above it (**Angle**) is also shown. Select **Next** to proceed with the entry of parameters needed for the optimization sequence or select **Back** to return to the Main Menu.

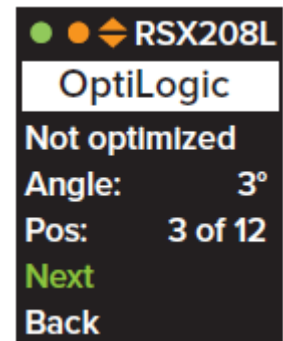

1. Enter the Array Height, measured as the distance between the ground and the Top of the upper-most RSX208L in the array.
Rotate the DSP Navigation / Edit Wheel to highlight **Top** then press it.
Rotate the DSP Navigation / Edit Wheel to specify the height then press it to enter the value.
The array height parameter ranges from minimum 0 m/feet to maximum 99.0 m / 324 feet
Select **Next** to proceed with the optimization sequence.
Select **Back** to return to the OptiLogic sub-menu.
2. Enter the Audience parameters, measured as the distance from the point on the ground directly beneath front of the array to the Front and to the Rear of the desired coverage area.
Rotate the DSP Navigation / Edit Wheel to highlight **Front** then press it.
Rotate the DSP Navigation / Edit Wheel to specify the distance then press it to enter the value.
Rotate the DSP Navigation / Edit Wheel to highlight **Rear** then press it.
Rotate the DSP Navigation / Edit Wheel to specify the distance then press it to enter the value.
Front and Rear parameters range from minimum 0 m/feet to maximum 999.0 m / 3276 feet.
Select **Back** to return to the Array Height sub-menu.
3. Select **Optimize** to finalize parameter entry and initiate the optimization sequence. The display will indicate "Optimizing Array..." When optimization is complete, the OptiLogic sub-menu will be shown and status will indicate "Optimized".
4. Select **Back** to return to the Main Menu or **Next** to repeat the optimization sequence using different audience and array height parameters.

Upon completion of Automatic Optimization, settings for all RSX208L modules in the array are adjusted for optimum performance across the specified coverage area. Equalization adjustments are made to compensate for low frequency coupling depending upon the number of RSX208L modules in the array. Additional EQ is applied to compensate for high frequency energy loss between each RSX208L module and its defined coverage area.

Automatic Optimization functions independently for each discrete array employed in a multi-array system. Generally for a stereo line array system, the optimization sequence will be performed on both sides of the system utilizing the same Audience and Array Height settings per array. For more complex venues, differing settings can be utilized but care must be taken not to overlap coverage areas from these arrays.

Voicing

System optimization is further streamlined through the use of four pre-defined voicing profiles based upon feedback compiled from key touring and installation contacts. These provide a variety of tonal starting points depending on the musical style and user preference. In addition, one user-defined profile is available for selection, and can be configured using the EAW Mosaic application for iOS.

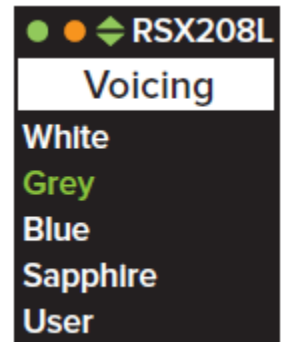

Below, the target response and a brief explanation are provided for each voicing.

White

White represents a nominally flat voicing. It should be used when the most neutral, uncolored system response is desired.

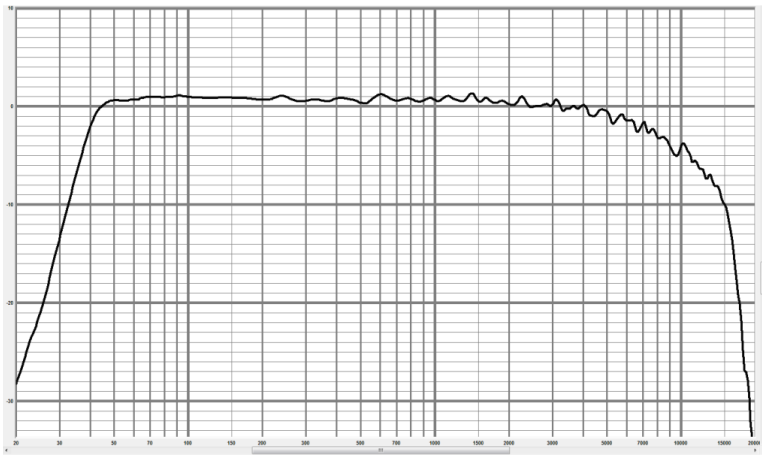

Grey

Compared to White, the Grey voicing provides a 1 dB low-frequency boost with a gradual high-frequency roll-off, reaching 4 dB at 10 kHz.

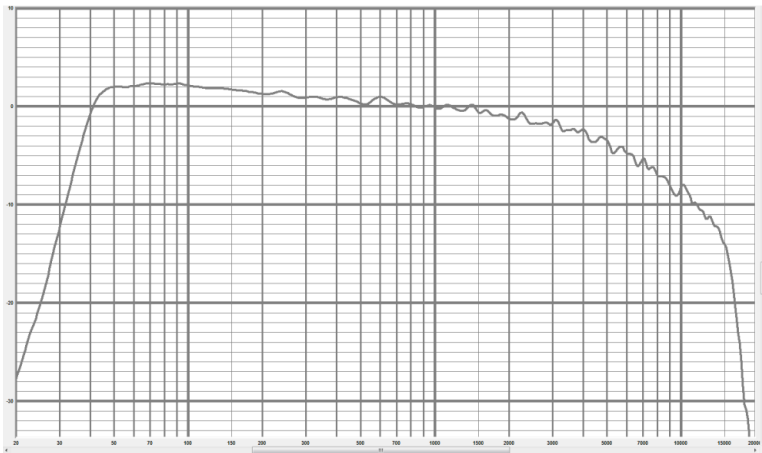

Blue

The Blue voicing provides a more significant 2 dB low-frequency boost, coupled with the same high-frequency roll-off as Grey, but with 2 dB more mid-frequency attenuation from 700 Hz to 8,000 Hz.

This voicing is most suitable for high-SPL performances with significant upper-mid content. The more extensive mid- and high-frequency attenuation is sometimes useful to combat fatigue with midrange-heavy instruments, as the ear is most sensitive to this range of frequencies.

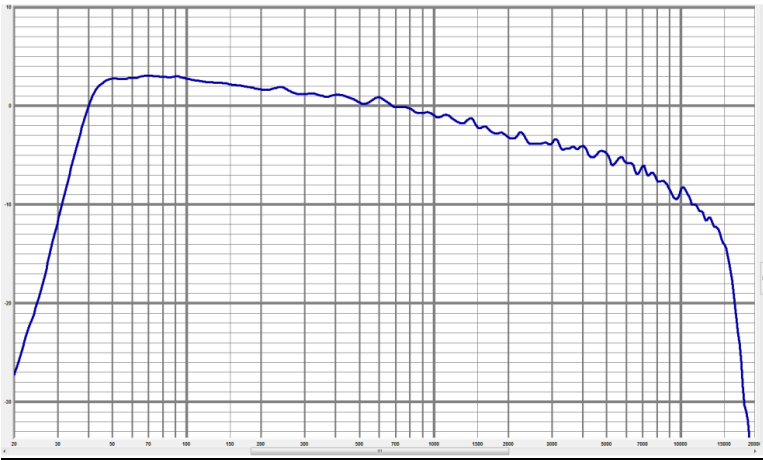

Sapphire

The Sapphire voicing combines the low-frequency boost and high-frequency attenuation of Blue, but with the addition of additional very high-frequency emphasis above 10 kHz for additional “air” and clarity. This voicing is especially suitable for high-quality audio playback (without the need for supplemental equalization), and was the result of feedback from a number of touring audio engineers.

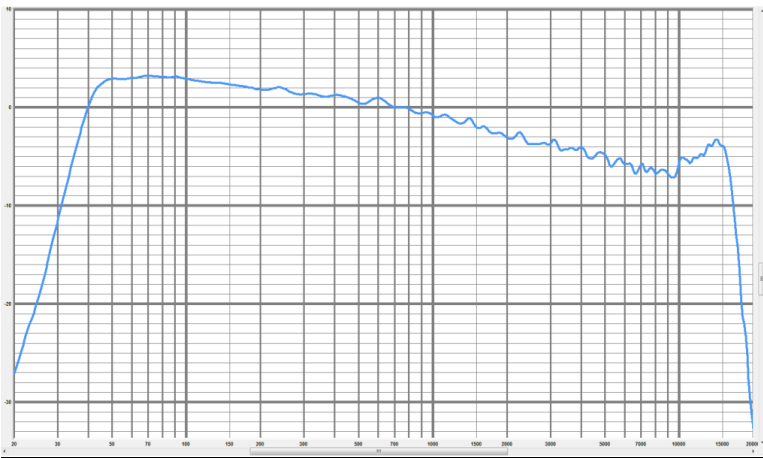

User

One voicing profile is reserved for the user to define and save for later recall. Using the EAW Mosaic application for iOS, the user can customize the voicing and store it to this profile. Later, loading the User voicing will recall the stored voicing profile. This profile remains in the loudspeaker’s memory until a factory reset is performed or until it is altered by a user via EAWmosaic.

Rotating the DSP Navigation / Edit Wheel changes the selected voicing profile in real time. Pressing the DSP Navigation / Edit Wheel, or after 5 seconds have passed with no press or turn of the DSP Navigation / Edit Wheel, the Main Menu is displayed.

Delay

Selecting Delay allows the user to adjust the loudspeaker’s alignment delay in 1 ms increments ranging from 0 to 150 ms in 0.1 ms increments between 0 and 10 ms and in 1 ms increments above 10 ms. For reference, the equivalent distance is displayed in meters and in feet. Rotating the DSP Navigation / Edit Wheel changes the delay value, and pressing it returns to the Main Menu. After 5

seconds have passed with no change to the Delay parameter the Home Screen is displayed.

Output Check

Transducers and amplifier channels can quickly be checked without the need for an external noise generator and any associated cables or test equipment. Individual transducers and amplifier channels can be tested manually or via an automated sequence.



Initiating Output Check automatically or manually will cause the loudspeaker to emit pink noise. To ensure against potentially dangerous exposure to high sound pressure levels, it is recommended that all persons exposed to equipment capable of producing high sound pressure levels use hearing protectors while the equipment is in operation.

Auto:

Using the Auto mode, a 2-second burst of pink noise is emitted first from the high-, then the mid- and then the low-frequency transducer. Lastly, another 2-second pink noise is emitted from all transducers simultaneously. To initiate the Auto Output Check sequence, follow these steps.

1. Rotate the DSP Navigation / Edit Wheel to select **Auto**.
2. Press the DSP Navigation / Edit Wheel to initiate the automatic test procedure.
Note: Status changes from "Start" to "Stop". Press it again to terminate the test sequence at any point.
3. A 2-second pink noise burst is emitted per transducer.
Note: When a channel is emitting pink noise, its status changes to indicate "On". It changes back to "Off" after the 2 second burst is complete.
4. A 2-second pink noise burst is emitted from all transducers simultaneously.
Note: Status for all drivers changes to "On" during this pink noise burst. They change back to "Off" upon completion.
5. Auto status changes to "Start" to signify the end of the Output Check cycle.

HF: MF: and LF:

Pink noise can be activated for manual testing of individual or combinations of transducers and their corresponding amplifier channels.

1. Rotate the DSP Navigation / Edit Wheel to select HF, MF or LF.
2. Press then turn the DSP Navigation / Edit Wheel to change the status to "On" and activate pink noise for the selected channel.
3. Press then turn the DSP Navigation / Edit Wheel to change the status to "Off" and deactivate pink noise for the selected channel.
Note: Pink noise can be activated for any combination of amplifier/transducer channels. Pink noise will continue to be emitted until the channel's status is manually changed to "Off" by the user or as a result of running the Auto Output Check sequence.

Select **Back** to exit Output Check and return to the Main Menu.

Settings

From the Settings menu, the user can configure LCD display preferences, restore the loudspeaker to factory default settings and view network address and firmware version information.

Screen:

To accommodate aesthetically sensitive situations where the bright LCD display may be distracting, the RSX208L provides three options for the user to optimize the LCD display behavior and brightness. To change settings, rotate the DSP Navigation / Edit Wheel to select Screen

Bright

This is the default setting suitable for well illuminated indoor/outdoor venues or when operating in bright sunlight.

Menu navigation and parameter entry is performed with the LCD display at maximum brightness. The Home Screen is also displayed at maximum brightness.

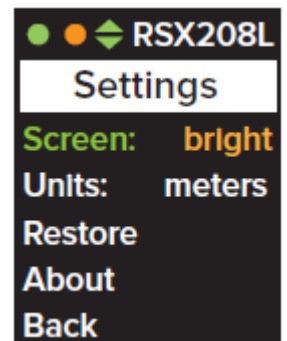
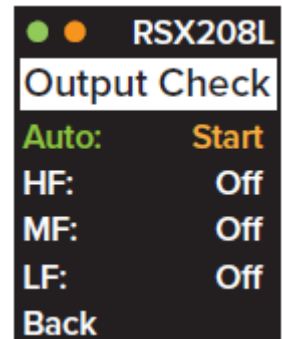

Dim

When maximum brightness settings become too distracting such as in darker theaters or evening outdoor events, the LDC display can be dimmed.

Menu navigation and parameter entry is performed with the LCD display at reduced brightness.

The Home Screen is also displayed at reduced brightness.

Off

For the most aesthetically sensitive applications, the home screen can be turned off.

Menu navigation and parameter entry is performed with the LCD display at maximum brightness.

The Home Screen is blank in this mode.

Units:

Select meters or feet as the preferred unit of measurement for height and distance parameter entry.

Restore:

Factory settings can quickly and easily be restored. This is convenient for users managing rental inventories or for resetting a mobile production system prior to deployment to the next venue or job site. It is also a good first step when troubleshooting loudspeakers exhibiting distorted audio, poor frequency response, low output, etc. Certain settings in the loudspeaker can only be accessed via the EAW Mosaic application for iOS. Sometimes these settings can be the cause of what appears to be poor performance when the speaker is isolated on the test bench or when compared to other units in inventory. All settings are reset to factory default when the Restore procedure is performed.

1. Rotate the DSP Navigation / Edit Wheel to select Restore.
2. Press the DSP Navigation / Edit Wheel and the "Restore factory defaults?" prompt appears.
3. Select "No" to return to the Settings sub-menu without changing any of the loudspeaker settings.
4. Select "Yes" to restore factory default settings and return to the Main Menu.

About:

The About screen provides the user with information about the loudspeaker's current input source, model number, firmware and network address details. Should you ever need to contact the EAW Application Support Group or EAW Service Department for assistance with your loudspeaker, you may be asked to provide some of the information presented here.





Radius RSX208L Home Screen

After 5 seconds have passed with no turn or press of the DSP Navigation / Edit Wheel the Home Screen is displayed showing primary settings, levels and statuses at a glance.

Three indicators and the loudspeaker model are shown at the top of the LCD display. This row of information is available on the Home Screen and Menu screens any time the display is illuminated.

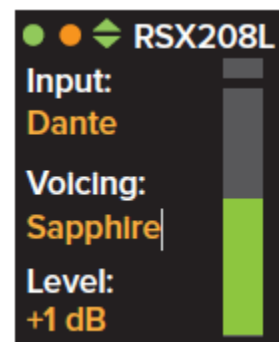
- Left - Status "LED" indicator
 - Green indicates that the loudspeaker is online and functioning normally.
 - Red indicates that the amplifier is clipping or that a fault has been detected in the loudspeaker system.
- Center – Ethernet Link "LED" indicator
 - Amber indicates that an Ethernet link has been established between the loudspeaker and a network switch or other Radius loudspeaker.



- Right - Automatic Array Detection indicators
 - Up and Down arrows illuminate to indicate that the RSX208L is part of an array and that another RSX208L or RSX12 is present above or below it.
 - White indicates that the RSX208L is part of an array that is ready to be optimized.
 - Green indicates that the RSX208L is part of an array that is currently optimized.
 - Amber indicates that the array was previously optimized but that something in the array has changed (eg. a splay angle has been altered, a speaker has been added to or removed from the array, etc).
 -  indicates that the loudspeaker was previously optimized, but that currently no other RSX208L is detected above or below it.

Input is indicated as Analog unless a Dante source is assigned to the loudspeaker.

Voicing indicates the currently selected voicing profile.

Level shows any gain adjustment from nominal that has been applied by the user.

Input level is indicated via meter on the right of the display, with clip indicator above it. The meter range is -60 to 0 dBFS with a color gradient from green to red. The input clip indicator is displayed when the input signal exceeds 0dBFS.

Radius RSX12 Menus

Upon power on and initialization of the subwoofer the Main Menu is displayed. Here the user can adjust the RSX12's output level, alignment delay settings, crossover configuration and user preferences, and initiate a test of the subwoofer's output.

If the Home Screen (see below) is displayed, pressing or turning the DSP Navigation / Edit Wheel reveals the Main Menu.

Level

Selecting Level allows the user to adjust the subwoofer's output level in 0.5 dB increments ranging from -10 dB to +10 dB. Rotating the DSP Navigation / Edit Wheel changes the level value and pressing it returns to the Main Menu. After 5 seconds have passed with no change to the Level parameter the Home Screen is displayed.

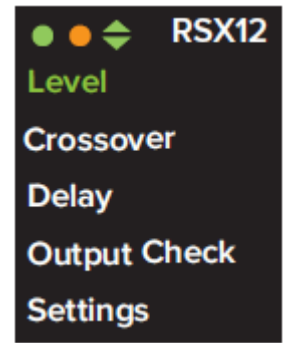

Crossover

Selecting Crossover allows the user to optimize the subwoofer for use with with other RADIUS models simply by selecting "with RSX Top".

Selecting Variable allows the user to enter a specific corner frequency to optimize the subwoofer for use with other loudspeakers. Rotate the DSP Navigation / Edit Wheel to highlight Var and then press it. Rotate the DSP Navigation / Edit Wheel to dial in the preferred frequency in 1Hz increments. Press DSP Navigation / Edit Wheel to enter the value.

Selecting Polarity allows the user to invert the subwoofer's polarity. Norm is the default mode.

Rotating the DSP Navigation / Edit Wheel changes the selected crossover settings in real time.

Pressing the DSP Navigation / Edit Wheel, or after 5 seconds have passed with no press or turn of the DSP Navigation / Edit Wheel, the Main Menu is displayed.

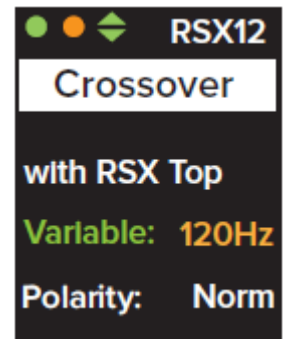

Delay

Selecting Delay allows the user to adjust the subwoofer's alignment delay in 1ms increments ranging from 0 to 150 ms in 0.1 ms increments between 0 and 10 ms and in 1 ms increments above 10 ms. For reference, the equivalent distance is displayed in meters and in feet. Rotating the DSP Navigation / Edit Wheel changes the delay value, and pressing it returns to the Main Menu. After 5 seconds have passed with no change to the Delay parameter the Home Screen is displayed.

Output Check

The subwoofer's transducer and amplifier can quickly be checked without the need for an external noise generator and any associated cables. It can be tested manually or via an automated sequence.



Initiating Output Check automatically or manually will cause the subwoofer to emit pink noise. To ensure against potentially dangerous exposure to high sound pressure levels, it is recommended that all persons exposed to equipment capable of producing high sound pressure levels use hearing protectors while the equipment is in operation.

Auto:

Using the Auto mode, a 2-second burst of pink noise is emitted from the low-frequency transducer. To initiate the Auto Output Check sequence, follow these steps.

1. Rotate the DSP Navigation / Edit Wheel to select **Auto**.
2. Press the DSP Navigation / Edit Wheel to initiate the automatic test procedure.
Note: Status changes from "Start" to "Stop". Press it again to terminate the test sequence at any point.
3. A 2-second pink noise burst is emitted.
Note: When the subwoofer is emitting pink noise, its status changes to indicate "On". It changes back to "Off" after the 2 second burst is complete.
4. Auto status changes to "Start" to signify the end of the Output Check cycle.

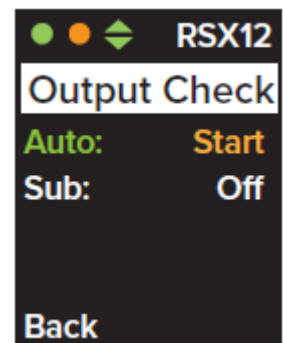

Sub:

Pink noise can be activated for manual testing of the subwoofer's transducer and amplifier.

1. Rotate the DSP Navigation / Edit Wheel to select Sub.
2. Press then turn the DSP Navigation / Edit Wheel to change the status to "On" and activate pink noise.
3. Press then turn the DSP Navigation / Edit Wheel to change the status to "Off" and deactivate pink noise.
Note: Pink noise will continue to be emitted until the Sub's status is manually changed to "Off" by the user or as a result of running the Auto Output Check sequence.

Select **Back** to exit Output Check and return to the Main Menu.

Settings

From the Settings menu, the user can configure LCD display preferences, restore the subwoofer to factory default settings and view network address and firmware version information.

Screen:

To accommodate aesthetically sensitive situations where the bright LCD display may be distracting, the RSX12 provides three options for the user to optimize the LCD display behavior and brightness. To change settings, rotate the DSP Navigation / Edit Wheel to select Screen

Bright

This is the default setting suitable for well illuminated indoor/outdoor venues or when operating in bright sunlight.

Menu navigation and parameter entry is performed with the LCD display at maximum brightness. The Home Screen is also displayed at maximum brightness.

Dim

When maximum brightness settings become too distracting such as in darker theaters or evening outdoor events, the LDC display can be dimmed.

Menu navigation and parameter entry is performed with the LCD display at reduced brightness. The Home Screen is also displayed at reduced brightness.

Off

For the most aesthetically sensitive applications, the home screen can be turned off.

Menu navigation and parameter entry is performed with the LCD display at maximum brightness. The Home Screen is blank in this mode.

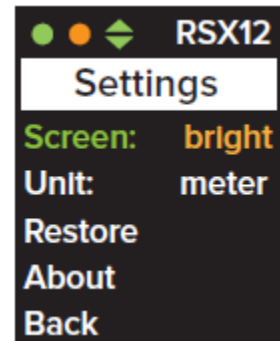
**Units:**

Select meters or feet as the preferred unit of measurement.

Restore:

Factory settings can quickly and easily be restored. This is convenient for users managing rental inventories or for resetting a mobile production system prior to deployment to the next venue or job site. It is also a good first step when troubleshooting subwoofers exhibiting distorted audio, poor frequency response, low output, etc. Certain settings in the subwoofer can only be accessed via the EAW Mosaic application for iOS. Sometimes these settings can be the cause of what appears to be poor performance when the subwoofer is isolated on the test bench or when compared to other units in inventory. All settings are reset to factory default when the Restore procedure is performed.

1. Rotate the DSP Navigation / Edit Wheel to select Restore.
2. Press the DSP Navigation / Edit Wheel and the “Restore factory defaults?” prompt appears.
3. Select “No” to return to the Settings sub-menu without changing any of the subwoofer settings.
4. Select “Yes” to restore factory default settings and return to the Main Menu.

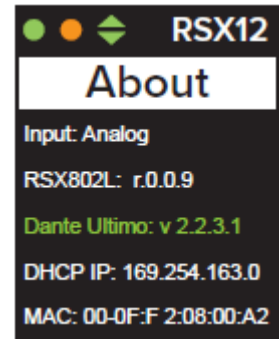

About:

The About screen provides the user with information about the subwoofer’s current input source, model number, firmware and network address details. Should you ever need to contact the EAW Application Support Group or EAW Service Department for assistance with your subwoofer, you may be asked to provide some of the information presented here.

Radius RSX12 Home Screen

After 5 seconds have passed with no turn or press of the DSP Navigation / Edit Wheel the Home Screen is displayed, showing primary settings, levels and statuses at a glance.

Three indicators and the subwoofer model are shown at the top of the LCD display. This row of information is available on the Home Screen and Menu screens any time the display is illuminated.

- Left - Status “LED” indicator
 - Green indicates that the subwoofer is online and functioning normally.
 - Red indicates that the amplifier is clipping or that a fault has been detected in the loudspeaker system.
- Center – Ethernet Link “LED” indicator
 - Amber indicates that an Ethernet link has been established between the loudspeaker and a network switch or other Radius loudspeaker.
- Right - Automatic Array Detection indicators
 - Up and Down arrows illuminate to indicate that the RSX12 is part of an array and that another RSX208L or RSX12 is present above or below it.
 - White indicates that the RSX12 is part of an array that is ready to be optimized.
 - Green indicates that the RSX12 is part of an array that is currently optimized.
 - Amber indicates that the array was previously optimized but that something in the array has changed (eg. a splay angle has been altered, a speaker has been added to or removed from the array, etc).
 -  indicates that the loudspeaker was previously optimized, but that currently no other RSX208L is detected above or below it.

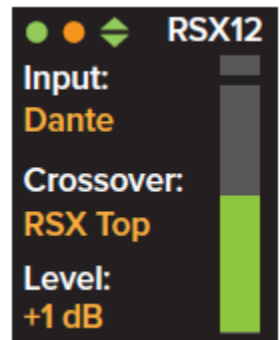

Input is indicated as Analog unless a Dante source is assigned to the loudspeaker.

Crossover indicates the currently selected crossover configuration.

Level shows any gain adjustment from nominal that has been applied by the user.

Input level is indicated via meter on the right of the display, with clip indicator above it. The meter range is -60 to 0 dBFS with a color gradient from green to red. The clip indicator is displayed when the input signal exceeds 0dBFS.

Radius RSX86 / RSX89 / RSX126 / RSX129 / RSX12M Menus

Upon power on and initialization of the loudspeaker the Main Menu is displayed. Here the user can adjust the full-range RSX's output level, alignment delay settings, voicing profile and user preferences and initiate a test of the loudspeaker's output.

If the Home Screen (see below) is displayed, pressing or turning the DSP Navigation / Edit Wheel reveals the Main Menu.

Level

Selecting Level allows the user to adjust the loudspeaker's output level in 0.5 dB increments ranging from -10 dB to +10 dB. Rotating the DSP Navigation / Edit Wheel changes the level value and pressing it returns to the Main Menu. After 5 seconds have passed with no change to the Level parameter the Home Screen is displayed.

Voicing

System optimization is further streamlined through the use of four pre-defined voicing profiles based upon feedback compiled from key touring and installation contacts. These provide a variety of tonal starting points depending on the musical style and user preference. In addition, one user-defined profile is available for selection, and can be configured using the EAW Mosaic application for iOS.

Below, the target response and a brief explanation are provided for each voicing.

White

White represents a nominally flat voicing. It should be used when the most neutral, uncolored system response is desired.

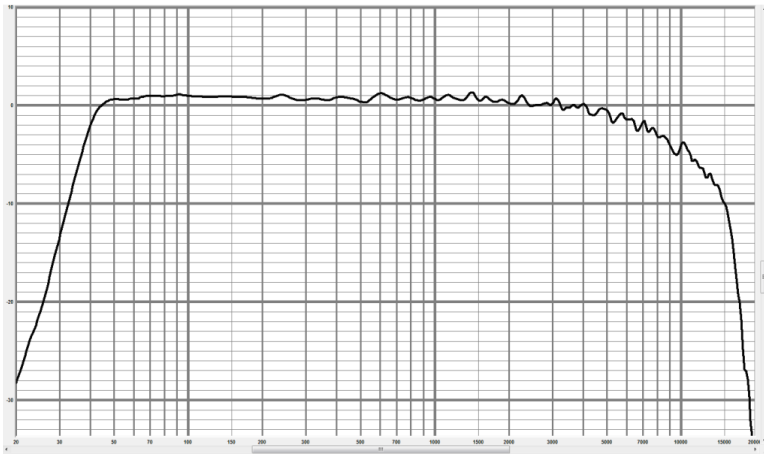

Grey

Compared to White, the Grey voicing provides a 1 dB low-frequency boost with a gradual high-frequency roll-off, reaching 4 dB at 10 kHz.

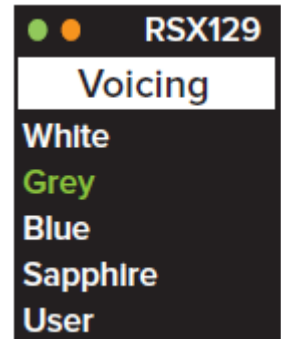
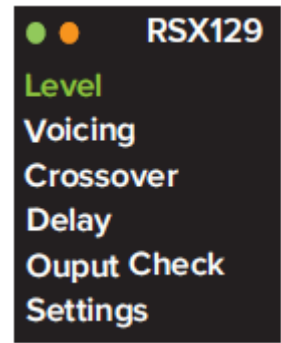

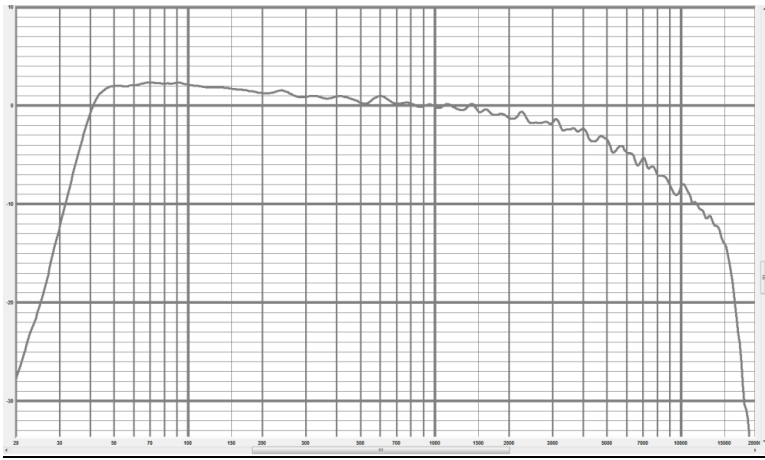

Blue

The Blue voicing provides a more significant 2 dB low-frequency boost, coupled with the same high-frequency roll-off as Grey, but with 2 dB more mid-frequency attenuation from 700 Hz to 8,000 Hz. This voicing is most suitable for high-SPL performances with significant upper-mid content. The more extensive mid- and high-frequency attenuation is sometimes useful to combat fatigue with midrange-heavy instruments, as the ear is most sensitive to this range of frequencies.

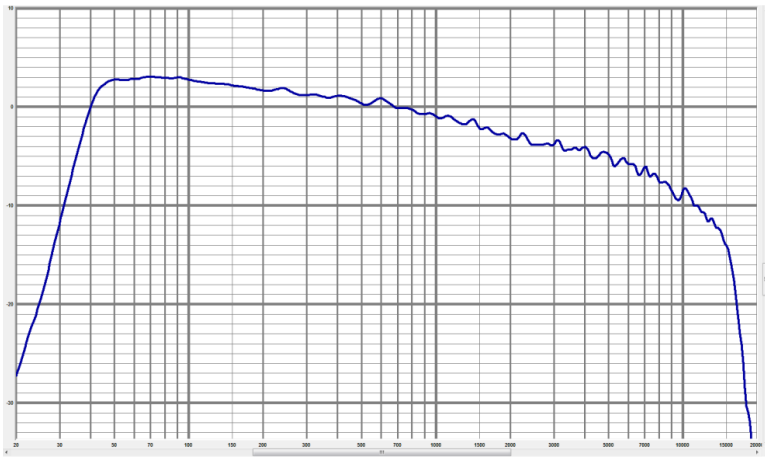

Sapphire

The Sapphire voicing combines the low-frequency boost and high-frequency attenuation of Blue, but with the addition of additional very high-frequency emphasis above 10 kHz for additional “air” and clarity. This voicing is especially suitable for high-quality audio playback (without the need for supplemental equalization), and was the result of feedback from a number of touring audio engineers.

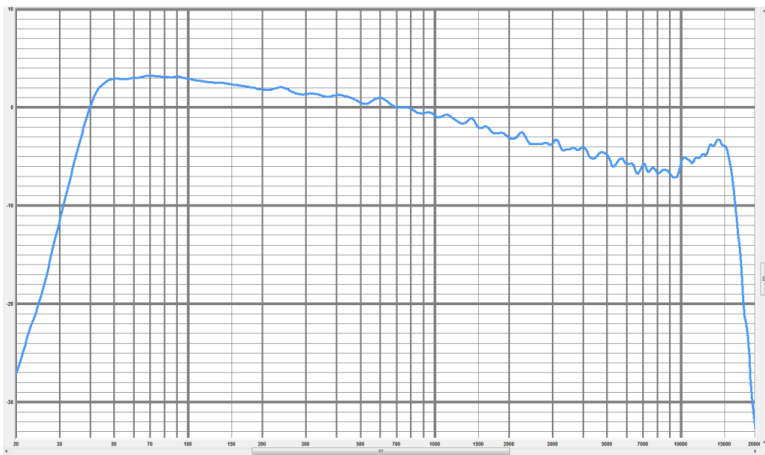

User

One voicing profile is reserved for the user to define and save for later recall. Using the EAW Mosaic application for iOS, the user can customize the voicing and store it to this profile. Later, loading the User voicing will recall the stored voicing profile. This profile remains in the loudspeaker's memory until a factory reset is performed or until it is altered by a user via EAWmosaic.

Rotating the DSP Navigation / Edit Wheel changes the selected voicing profile in real time. Pressing the DSP Navigation / Edit Wheel, or after 5 seconds have passed with no press or turn of the DSP Navigation / Edit Wheel, the Main Menu is displayed.

Crossover

Selecting Crossover allows the user to optimize the full range Radius loudspeaker for use with with RADIUS subwoofers simply by selecting "with RSX Sub".

Selecting Variable allows the user to enter a specific corner frequency to optimize the loudspeaker for use with other subwoofers, or if desired to roll off some of the low frequency output when used without a subwoofer. Rotate the DSP Navigation / Edit Wheel to highlight Var and then press it. Rotate the DSP Navigation / Edit Wheel to dial in the preferred frequency in 1Hz increments. Press DSP Navigation / Edit Wheel to enter the value.

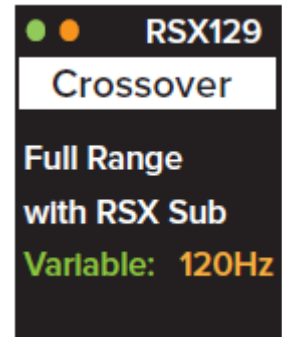

Full Range is the default mode.

Rotating the DSP Navigation / Edit Wheel changes the selected crossover settings in real time. Pressing the DSP Navigation / Edit Wheel, or after 5 seconds have passed with no press or turn of the DSP Navigation / Edit Wheel, the Main Menu is displayed.

Delay

Selecting Delay allows the user to adjust the loudspeaker's alignment delay in 1ms increments ranging from 0 to 150 ms in 0.1 ms increments between 0 and 10 ms and in 1 ms increments above 10 ms. For reference, the equivalent distance is displayed in meters and in feet. Rotating the DSP Navigation / Edit Wheel changes the delay value, and pressing it returns to the Main Menu. After 5 seconds have passed with no change to the Delay parameter the Home Screen is displayed.

Output Check

Transducers and amplifier channels can quickly be checked without the need for an external noise generator and any associated cables. Individual transducers and amplifier channels can be tested manually or via an automated sequence.



Initiating Output Check automatically or manually will cause the loudspeaker to emit pink noise. To ensure against potentially dangerous exposure to high sound pressure levels, it is recommended that all persons exposed to equipment capable of producing high sound pressure levels use hearing protectors while the equipment is in operation.

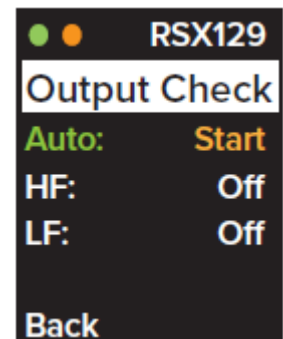

Auto:

Using the Auto mode, a 2-second burst of pink noise is emitted first from the high-, then the mid- and then the low-frequency transducer. Lastly, another 2-second pink noise is emitted from all transducers simultaneously. To initiate the Auto Output Check sequence, follow these steps.

6. Rotate the DSP Navigation / Edit Wheel to select **Auto**.
7. Press the DSP Navigation / Edit Wheel to initiate the automatic test procedure.
Note: Status changes from "Start" to "Stop". Press it again to terminate the test sequence at any point.
8. A 2-second pink noise burst is emitted per transducer.
Note: When a channel is emitting pink noise, its status changes to indicate "On". It changes back to "Off" after the 2 second burst is complete.
9. A 2-second pink noise burst is emitted from all transducers simultaneously.
Note: Status for all drivers changes to "On" during this pink noise burst. They change back to "Off" upon completion.
10. Auto status changes to "Start" to signify the end of the Output Check cycle.

HF: and LF:

Pink noise can be activated for manual testing of individual or combinations of transducers and their corresponding

amplifier channels.

4. Rotate the DSP Navigation / Edit Wheel to select HF or LF.
5. Press then turn the DSP Navigation / Edit Wheel to change the status to "On" and activate pink noise for the selected channel.
6. Press then turn the DSP Navigation / Edit Wheel to change the status to "Off" and deactivate pink noise for the selected channel.

Note: Pink noise can be activated for any combination of amplifier/transducer channels. Pink noise will continue to be emitted until the channel's status is manually changed to "Off" by the user or as a result of running the Auto Output Check sequence.

Select **Back** to exit Output Check and return to the Main Menu.

Settings

From the Settings menu, the user can configure LCD display preferences, restore the loudspeaker to factory default settings and view network address and firmware version information.

Screen:

To accommodate aesthetically sensitive situations where the bright LCD display may be distracting, the RSX208L provides three options for the user to optimize the LCD display behavior and brightness. To change settings, rotate the DSP Navigation / Edit Wheel to select Screen

Bright

This is the default setting suitable for well illuminated indoor/outdoor venues or when operating in bright sunlight.

Menu navigation and parameter entry is performed with the LCD display at maximum brightness.

The Home Screen is also displayed at maximum brightness.

Dim

When maximum brightness settings become too distracting such as in darker theaters or evening outdoor events, the LDC display can be dimmed.

Menu navigation and parameter entry is performed with the LCD display at reduced brightness.

The Home Screen is also displayed at reduced brightness.

Off

For the most aesthetically sensitive applications, the home screen can be turned off.

Menu navigation and parameter entry is performed with the LCD display at maximum brightness.

The Home Screen is blank in this mode.

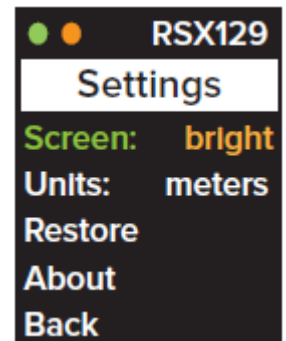

Units:

Select meters or feet as the preferred unit of measurement for height and distance parameter entry.

Restore:

Factory settings can quickly and easily be restored. This is convenient for users managing rental inventories or for resetting a mobile production system prior to deployment to the next venue or job site. It is also a good first step when troubleshooting loudspeakers exhibiting distorted audio, poor frequency response, low output, etc. Certain settings in the loudspeaker can only be accessed via the EAW Mosaic application for iOS. Sometimes these settings can be the cause of what appears to be poor performance when the speaker is isolated on the test bench or when compared to other units in inventory. All settings are reset to factory default when the Restore procedure is performed.

5. Rotate the DSP Navigation / Edit Wheel to select Restore.
6. Press the DSP Navigation / Edit Wheel and the "Restore factory defaults?" prompt appears.
7. Select "No" to return to the Settings sub-menu without changing any of the loudspeaker settings.
8. Select "Yes" to restore factory default settings and return to the Main Menu.

About:

The About screen provides the user with information about the loudspeaker's current input source, model number, firmware and network address details. Should you ever need to contact the EAW Application Support Group or EAW Service Department for assistance with your loudspeaker, you may be asked to provide some of the information presented here.

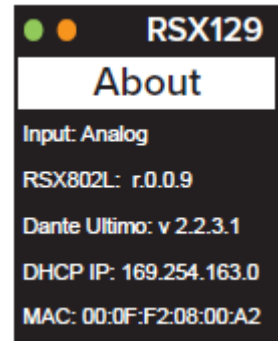

Radius RSX86 / RSX89 / RSX126 / RSX129 / RSX12M Home Screen

After 5 seconds have passed with no turn or press of the DSP Navigation / Edit Wheel the Home Screen is displayed showing primary settings, levels and statuses at a glance.

Two indicators and the loudspeaker model are shown at the top of the LCD display. This row of information is available on the Home Screen and Menu screens any time the display is illuminated.

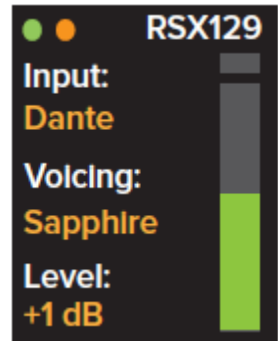

- Left - Status "LED" indicator
 - Green indicates that the loudspeaker is online and functioning normally.
 - Red indicates that the amplifier is clipping or that a fault has been detected in the loudspeaker system.
- Right – Ethernet Link "LED" indicator
 - Amber indicates that an Ethernet link has been established between the loudspeaker and a network switch or other Radius loudspeaker.

Input is indicated as Analog unless a Dante source is assigned to the loudspeaker.

Voicing indicates the currently selected voicing profile.

Level shows any gain adjustment from nominal that has been applied by the user.

Input level is indicated via meter on the right of the display, with clip indicator above it. The meter range is -60 to 0 dBFS with a color gradient from green to red. The input clip indicator is displayed when the input signal exceeds 0dBFS.

Radius RSX18 / RSX218 Menus

Upon power on and initialization of the subwoofer the Main Menu is displayed. Here the user can adjust the RSX18 or RSX218's output level, alignment delay settings, crossover configuration and user preferences, setup cardioid mode and initiate a test of the subwoofer's output.

If the Home Screen (see below) is displayed, pressing or turning the DSP Navigation / Edit Wheel reveals the Main Menu.

Level

Selecting Level allows the user to adjust the subwoofer's output level in 0.5 dB increments ranging from -10 dB to +10 dB. Rotating the DSP Navigation / Edit Wheel changes the level value and pressing it returns to the Main Menu. After 5 seconds have passed with no change to the Level parameter the Home Screen is displayed.

Crossover

Selecting Crossover allows the user to optimize the subwoofer for use with with other RADIUS models simply by selecting "with RSX Top".

Selecting Variable allows the user to enter a specific corner frequency to optimize the subwoofer for use with other loudspeakers. Rotate the DSP Navigation / Edit Wheel to highlight Var and then press it. Rotate the DSP Navigation / Edit Wheel to dial in the preferred frequency in 1Hz increments. Press DSP Navigation / Edit Wheel to enter the value.

Selecting Polarity allows the user to invert the subwoofer's polarity. Norm is the default mode.

Rotating the DSP Navigation / Edit Wheel changes the selected crossover settings in real time. Pressing the DSP Navigation / Edit Wheel, or after 5 seconds have passed with no press or turn of the DSP Navigation / Edit Wheel, the Main Menu is displayed.

Cardioid

Selecting Cardioid allows the user to configure the subwoofer for Cardioid functionality. In Cardioid mode, 2 or 3 subwoofers must be stacked together with one facing toward the rear. In a 2 subwoofer Cardioid setup, the top subwoofer faces to the rear. In a 3 subwoofer Cardioid setup, the middle subwoofer faces the rear.

Pressing then rotating the DSP Navigation / Edit Wheel allows for selection of 1 (normal mode / non-Cardioid), 2 or 3 (Cardioid mode) subwoofers. Once the proper configuration is selected (for 2 or 3 subwoofer Cardioid configurations) pressing then turning the DSP Navigation / Edit Wheel allows the user to identify the position of the subwoofer in the Cardioid setup (top or bottom in a 2 subwoofer setup and top, middle or bottom in a 3 subwoofer setup). Once the proper position is selected, pressing the DSP Navigation / Edit Wheel returns the user to the Main Menu. This procedure should be performed for each subwoofer in a cardioid setup.

Delay

Selecting Delay allows the user to adjust the subwoofer's alignment delay in 1 ms increments ranging from 0 to 150 ms in 0.1 ms increments between 0 and 10 ms and in 1 ms increments above 10 ms. For reference, the equivalent distance is displayed in meters and in feet. Rotating the DSP Navigation / Edit Wheel changes the delay value, and pressing it returns to the Main Menu. After 5 seconds have passed with no change to the Delay parameter the Home Screen is displayed.

Output Check

The subwoofer's transducer and amplifier can quickly be checked without the need for an external noise generator and any associated cables. It can be tested manually or via an automated sequence.

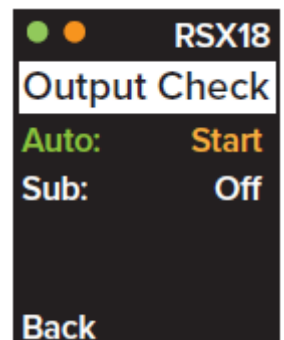
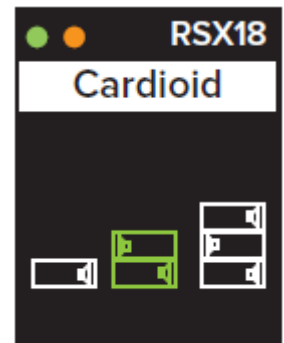
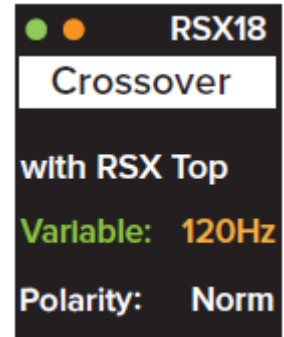
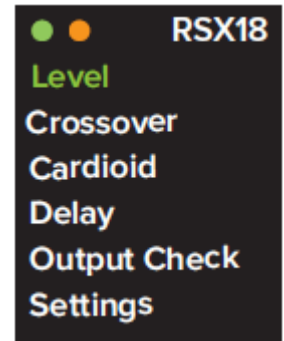



Initiating Output Check automatically or manually will cause the subwoofer to emit pink noise. To ensure against potentially dangerous exposure to high sound pressure levels, it is recommended that all persons exposed to equipment capable of producing high sound pressure levels use hearing protectors while the equipment is in operation.

Auto:

Using the Auto mode, a 2-second burst of pink noise is emitted from the low-frequency transducer. To initiate the Auto Output Check sequence, follow these steps.

5. Rotate the DSP Navigation / Edit Wheel to select **Auto**.
6. Press the DSP Navigation / Edit Wheel to initiate the automatic test procedure.
Note: Status changes from "Start" to "Stop". Press it again to terminate the test sequence at any point.
7. A 2-second pink noise burst is emitted.
Note: When the subwoofer is emitting pink noise, its status changes to indicate "On". It changes back to "Off" after the 2 second burst is complete.
8. Auto status changes to "Start" to signify the end of the Output Check cycle.

Sub:

Pink noise can be activated for manual testing of the subwoofer's transducer and amplifier.

4. Rotate the DSP Navigation / Edit Wheel to select Sub.
5. Press then turn the DSP Navigation / Edit Wheel to change the status to "On" and activate pink noise.
6. Press then turn the DSP Navigation / Edit Wheel to change the status to "Off" and deactivate pink noise.
Note: Pink noise will continue to be emitted until the Sub's status is manually changed to "Off" by the user or as a result of running the Auto Output Check sequence.

Select **Back** to exit Output Check and return to the Main Menu.

Settings

From the Settings menu, the user can configure LCD display preferences, restore the subwoofer to factory default settings and view network address and firmware version information.

Screen:

To accommodate aesthetically sensitive situations where the bright LCD display may be distracting, the RSX12 provides three options for the user to optimize the LCD display behavior and brightness. To change settings, rotate the DSP Navigation / Edit Wheel to select Screen

Bright

This is the default setting suitable for well illuminated indoor/outdoor venues or when operating in bright sunlight.

Menu navigation and parameter entry is performed with the LCD display at maximum brightness.

The Home Screen is also displayed at maximum brightness.

Dim

When maximum brightness settings become too distracting such as in darker theaters or evening outdoor events, the LDC display can be dimmed.

Menu navigation and parameter entry is performed with the LCD display at reduced brightness.

The Home Screen is also displayed at reduced brightness.

Off

For the most aesthetically sensitive applications, the home screen can be turned off.

Menu navigation and parameter entry is performed with the LCD display at maximum brightness.

The Home Screen is blank in this mode.

Units:

Select meters or feet as the preferred unit of measurement.

Restore:

Factory settings can quickly and easily be restored. This is convenient for users managing rental inventories or for resetting a

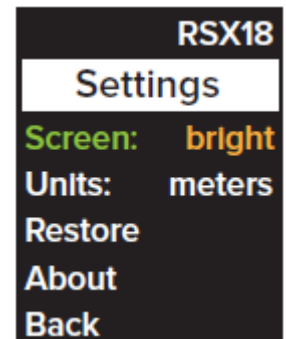

mobile production system prior to deployment to the next venue or job site. It is also a good first step when troubleshooting subwoofers exhibiting distorted audio, poor frequency response, low output, etc. Certain settings in the subwoofer can only be accessed via the EAW Mosaic application for iOS. Sometimes these settings can be the cause of what appears to be poor performance when the subwoofer is isolated on the test bench or when compared to other units in inventory. All settings are reset to factory default when the Restore procedure is performed.

5. Rotate the DSP Navigation / Edit Wheel to select Restore.
6. Press the DSP Navigation / Edit Wheel and the "Restore factory defaults?" prompt appears.
7. Select "No" to return to the Settings sub-menu without changing any of the subwoofer settings.
8. Select "Yes" to restore factory default settings and return to the Main Menu.

About:

The About screen provides the user with information about the subwoofer's current input source, model number, firmware and network address details. Should you ever need to contact the EAW Application Support Group or EAW Service Department for assistance with your subwoofer, you may be asked to provide some of the information presented here.



Radius RSX18 / RSX218 Home Screen

After 5 seconds have passed with no turn or press of the DSP Navigation / Edit Wheel the Home Screen is displayed, showing primary settings, levels and statuses at a glance.

Two indicators and the loudspeaker model are shown at the top of the LCD display. This row of information is available on the Home Screen and Menu screens any time the display is illuminated.

- Left - Status "LED" indicator
 - Green indicates that the loudspeaker is online and functioning normally.
 - Red indicates that the amplifier is clipping or that a fault has been detected in the loudspeaker system.
- Right – Ethernet Link "LED" indicator
 - Amber indicates that an Ethernet link has been established between the loudspeaker and a network switch or other Radius loudspeaker.

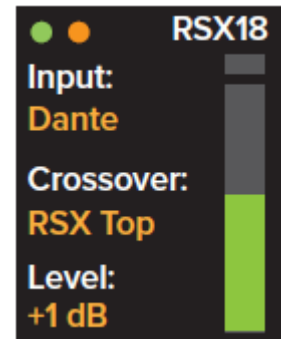

Input is indicated as Analog unless a Dante source is assigned to the loudspeaker.

Crossover indicates the currently selected crossover configuration.

Level shows any gain adjustment from nominal that has been applied by the user.

Input level is indicated via meter on the right of the display, with clip indicator above it. The meter range is -60 to 0 dBFS with a color gradient from green to red. The clip indicator is displayed when the input signal exceeds 0dBFS.

Introduction

Dante – Digital Audio Network Through Ethernet – is the de facto standard in digital audio networking, delivering unmatched audio quality, extremely flexible routing and offers significant cost savings compared to traditional analog cable runs.

RADIUS Series loudspeakers may be connected to any Dante-enabled audio network. As such, it is a perfect solution for connecting to a Dante-enabled mixer. In fact, the Mackie AXIS system is a prime candidate!

The dual Dante ports allow daisy chaining and the dedicated Wi-Fi control port eliminates the need for an Ethernet switch in many situations.

With flawless interoperation with hundreds of Dante-enabled products and a rock solid, glitch-free operation, the Dante connectors truly expand the RADIUS Series' functionality and application-flexibility in any professional environment.

Why use Dante?

Why use Dante? There simply isn't enough space here to explain *all* of the benefits of Dante, but here's a small sampling:

- Automatic configuration
- Uncompressed low latency digital audio: >150 µs
- High channel count: up to 1024 (512 x 512) channels per link
- Maximum sampling rate: 192 kHz
- Maximum bit depth: 32 bits
- Switchable and routable
- Can easily handle long distances and/or multiple locations
- Daisy-chain or use for system redundancy
- Massive cost savings

Using a Wi-Fi Router with EAWmosaic

EAWmosaic connects to RADIUS via a user-provided wi-fi router. No special features are required from the router except that it provides both wired and wireless connectivity. It is recommended that the router also include a DHCP server to simplify IP address assignment. Any standard wi-fi router will work well with RADIUS, including: Apple Airport, Airport Extreme, Monoprice AC1200.

When connecting the wi-fi router to the RADIUS network, it is important to remember the following rules:

1. Do not exceed 10 'hops' when looping network on RADIUS modules.
2. Connect the wi-fi router to a 'filtered' port on the rear of a RADIUS enclosure (or Mackie DL32R mixer). These ports have an RJ-45 connector (instead of EtherCon) and are labeled "COMM" and remove the Dante audio traffic to maximize the router's ability to handle control data and communicate with the iPad. Using a 'Dante' port for this purpose will also work, but you may experience reduced communication performance when online with the system via EAWmosaic.
3. For best results, keep the RADIUS network isolated from corporate or enterprise networks with significant other traffic. Networks providing internet access and other non-essential functions can significantly reduce network performance, including slowing system discovery and control and in extreme cases, compromising Dante audio.

Mastering EAWmosaic



Introduction

While much of the control is available on the full-color screen and controller on the rear panel of each RADIUS series speaker, the real power happens when using the EAWmosaic application. The EAWmosaic app helps users set up and configure their RADIUS-based sound systems so they sound as good as possible. It does this through discovery, configuration, control, monitoring and venue optimization via Wi-Fi.

What is EAWmosaic?

With an extremely approachable design for engineers and system techs of all levels, EAWmosaic offers powerful design, prediction and system optimization. This single, comprehensive app solution delivers intuitive and powerful control over your RADIUS system. EAWmosaic allows one to virtually model, predict and evaluate a loudspeaker system's performance for any user-defined venue. It will also predict direct SPL levels and frequency response throughout this virtual venue. Most importantly, it allows you to model a design that is safe for your application.

Why use EAWmosaic?

EAWmosaic should be installed and utilized for a multitude of reasons.

First, it is predictive software that helps predetermine any issues that may arise, including safety, weight, angle, flybar and more.

EAWmosaic also determines coverage. Are the SPL and frequency response as desired everywhere in the venue? Should three or four arrays be used? How many subwoofers should be employed in this particular system? Should the subwoofer(s) be flown or placed on the floor? What voicing mode is best for this system? Find out the answers to these questions, and more, using this app.

It is a great tool for pre-sales, as well. Customers will be able to see the final setup prior to any purchase. Therefore, realistic expectations have been set for all interested parties which results in a better relationship between the buyer and seller.

Finally, it is a great educational tool with a great price...FREE!

For complete instructions about operating EAWmosaic, please read the EAWmosaic Help File. EAWmosaic should always be used to model any new installations to ensure that the design is safe.

How does EAWmosaic work?

You will have to review the EAWmosaic Help File in order to really dig in and find out how it works, but in a nutshell EAWmosaic works by helping you improve the sound of your rig. Significant features such as loudspeaker discovery, grouping, control, monitoring and venue optimization are provided via a Wi-Fi connected iPad or offline in advance of a gig.

Additionally, when a Dante-enabled mixer (or other Dante source) is connected to RADIUS loudspeakers via the Dante network, you're able to route Dante signals from the network directly to the RADIUS speakers.

Together these features help you decide which speakers to use for a particular venue, where to place them in the venue and how to configure them for the best results possible. It lets you control them live and make changes on site to get the best sounding rig as possible. And if there is a problem with a speaker, it helps diagnose and work around the issue.

Device and Download Requirements

EAWmosaic control software is run on an Apple iPad. EAWmosaic requires at least one (and allows up to 10) iPads running iOS 8 or higher. iPads running anything other than iOS 8 or higher are not supported. EAWmosaic is completely useable offline for design purposes with local file saving. These settings can then be applied to a connected system later. Supported devices are listed with the technical specifications, page 22.

There are a couple of ways to download and install the EAWmosaic app. Via iTunes on Mac or PC, for example. However, the easiest and fastest way to download and install it is directly from the device. You've downloaded apps before and it's the same method to download this one, as well. Having said that, complete download and install instructions may be found by visiting the EAWmosaic Reference Guide.

Array Quick-Start Guide

In almost all cases, it is essential for the operator to employ EAWmosaic to perform a system prediction in advance of flying an array of RSX208L or RSX12. However, this section provides a series of pre-approved rigging configurations for specific 'typical' use cases. As long as the array is rigged in exactly the way specified herein, the below configurations adhere to 10:1 design factor.

NOTE: These do not represent 'maximum throws', but rather are intended to provide a range of pre-defined configurations that will provide excellent results for typical applications. Greater throws and consistency are possible by manipulating trim height, array angles and configurations. For any configuration other than those listed here, always use EAWmosaic or EAW Resolution to confirm that the configuration is safe and conforms to the needed design factor (specified by the user).

Small Venue, Ground-Supported Array on Stand

This configuration is extremely useful when high output and control is needed but space is very limited and a traditional flown or ground-stacked array is not possible. Two RSX208L on a stand constitutes an extremely high-power 'point and shoot' solution in place of a more traditional 12" or 15" two-way loudspeaker, with the advantages of greater output and vertical control to avoid directing excess energy into the ceiling or floor of a venue.

Equipment:	(2) RSX208L per cluster (1) SBX100 on standard tripod stand
Max Audience Distance:	50 feet/15.5m
Continuous SPL:	107 – 95 dBA from 10ft/3.1m to 50ft/15.5m
Angles:	3 degrees (between RSX208L modules)

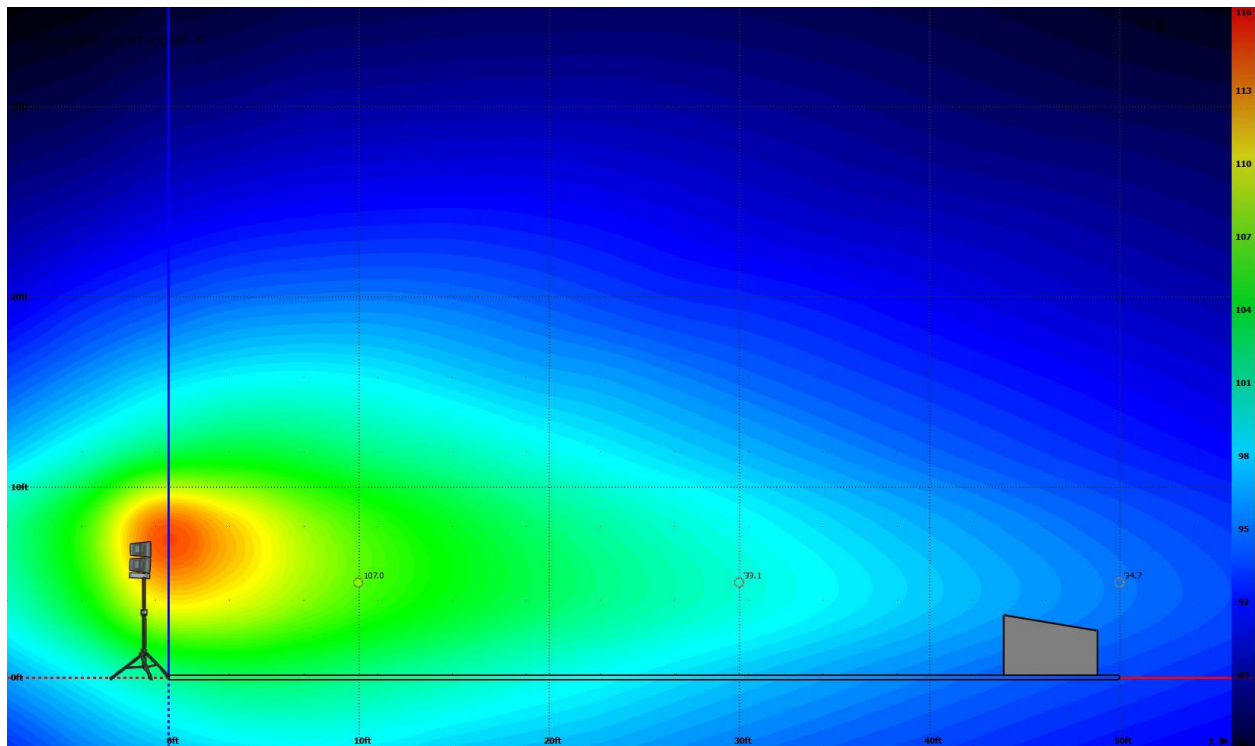

Ground-Supported Array, 100-foot Throw

When rigging points are not available to an array, RSX208L can be ground-stacked on the flybar to form a very high-output, controlled PA system. For this configuration, it is strongly recommended to elevate the system such that some or all of the RSX208L enclosures are above head-height. The RSX12 subwoofer can also be used for this purpose.

Equipment:	(4) RSX208L per cluster (1) RSX12 per cluster
Max Audience Distance:	100 ft/15.6 m
Stage Height:	5 ft/1.5m
Continuous SPL:	107 – 100 dBA from 10ft/3.1m to 100ft/31m
Rigging Configuration:	Splays: 0 (RSX208L #1-flybar), 0, 0, 0
Total System Weight:	238 lbs/108 kg

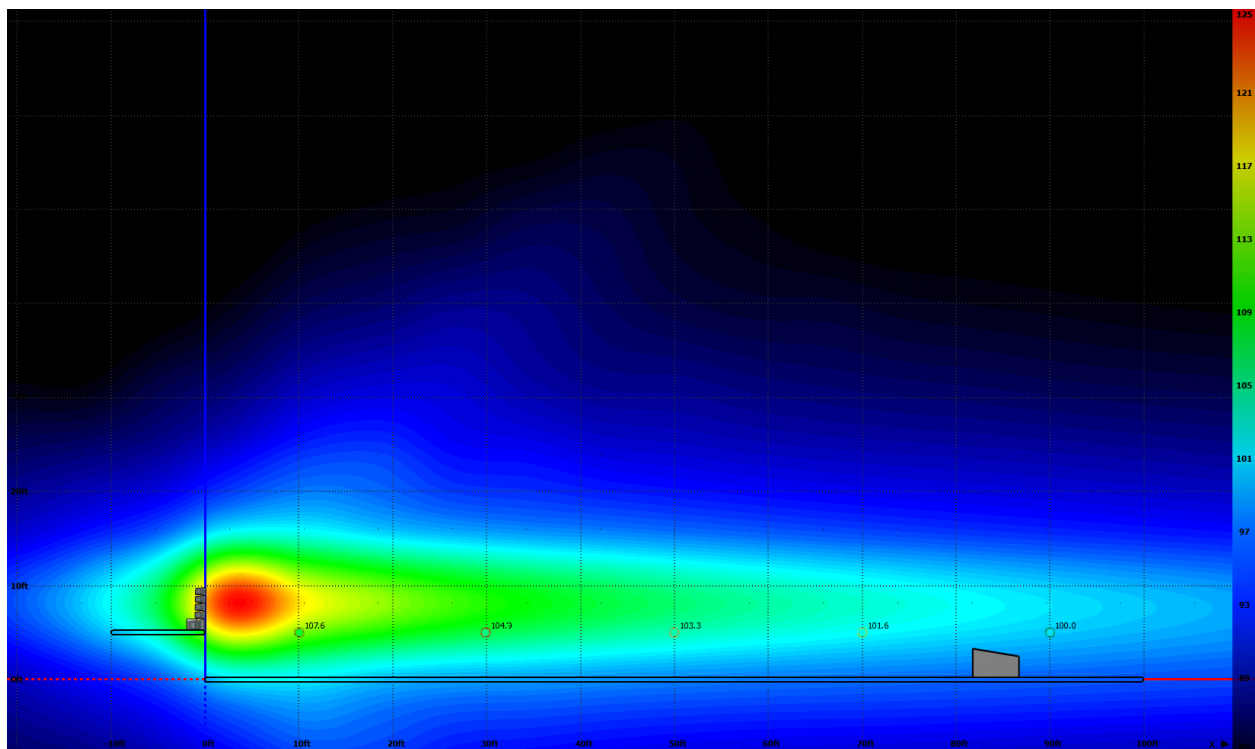

Flown Array, 100-Foot Throw

For this configuration, (4) RSX208L are flown at a height corresponding to a portable stage or crank-up stand. Coverage and SPL is very good to a distance of approximately 100ft/15.6m.

Equipment:	(1) FBX100 (4) RSX208L per cluster
Max Audience Distance:	100 ft/15.6 m
Trim Height:	18 ft/5.5 m
Continuous SPL:	103 – 96 dBA from 10ft/3.1m to 100ft/31m
Rigging Configuration:	Flybar: Position 4 Splays: 0 (RSX208L #1-flybar), 3, 9, 12
Total System Weight:	198 lbs/90 kg

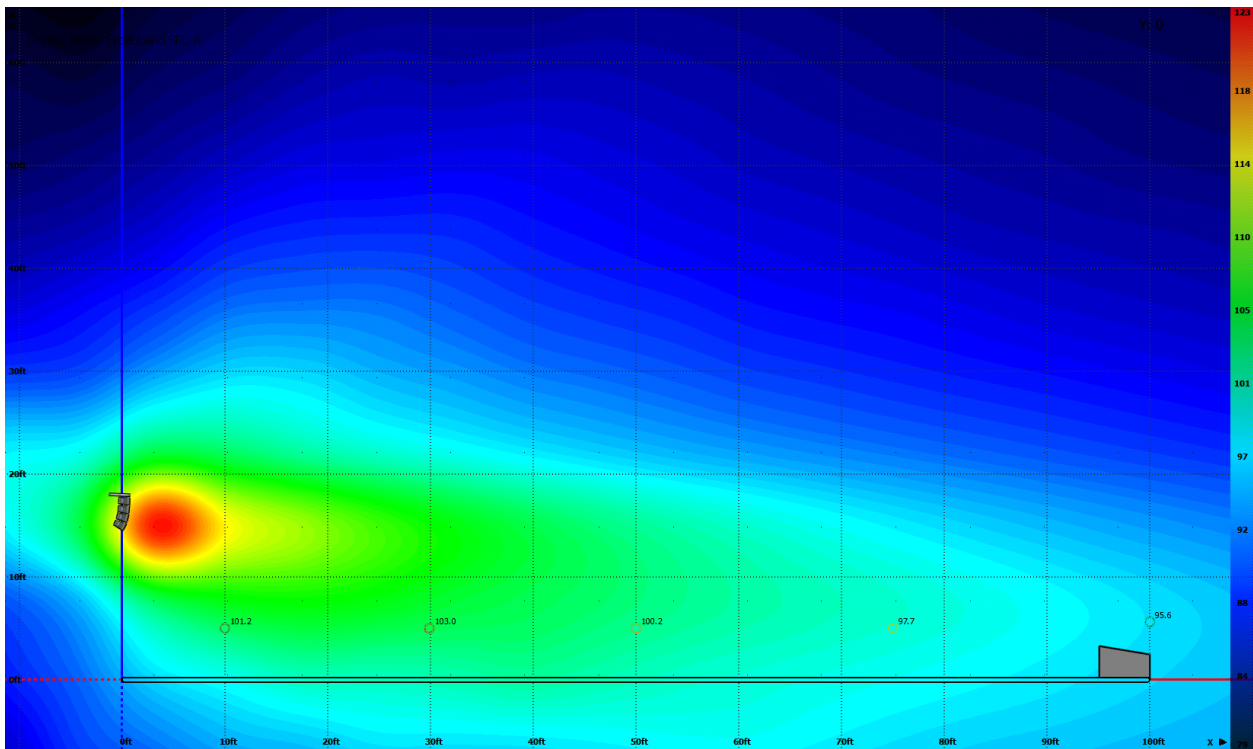

Flown Array, 150-foot Throw

For this configuration, (6) RSX208L are flown at a height corresponding to a portable stage or crank-up stand. Coverage and SPL is extended, and consistency from front to back is improved due to the larger array's improved pattern control.

Equipment:	(1) FBX100 per cluster (6) RSX208L per cluster
Max Audience Distance:	150 ft/46 m
Trim Height:	18 ft/5.5 m
Continuous SPL:	104 – 95 dBA from 10ft/3.1m to 150ft/46m
Rigging Configuration:	Flybar: Position 4 Splays: 0 (RSX208L #1-flybar), 0, 3, 6, 9, 12
Total System Weight:	279 lbs/126 kg

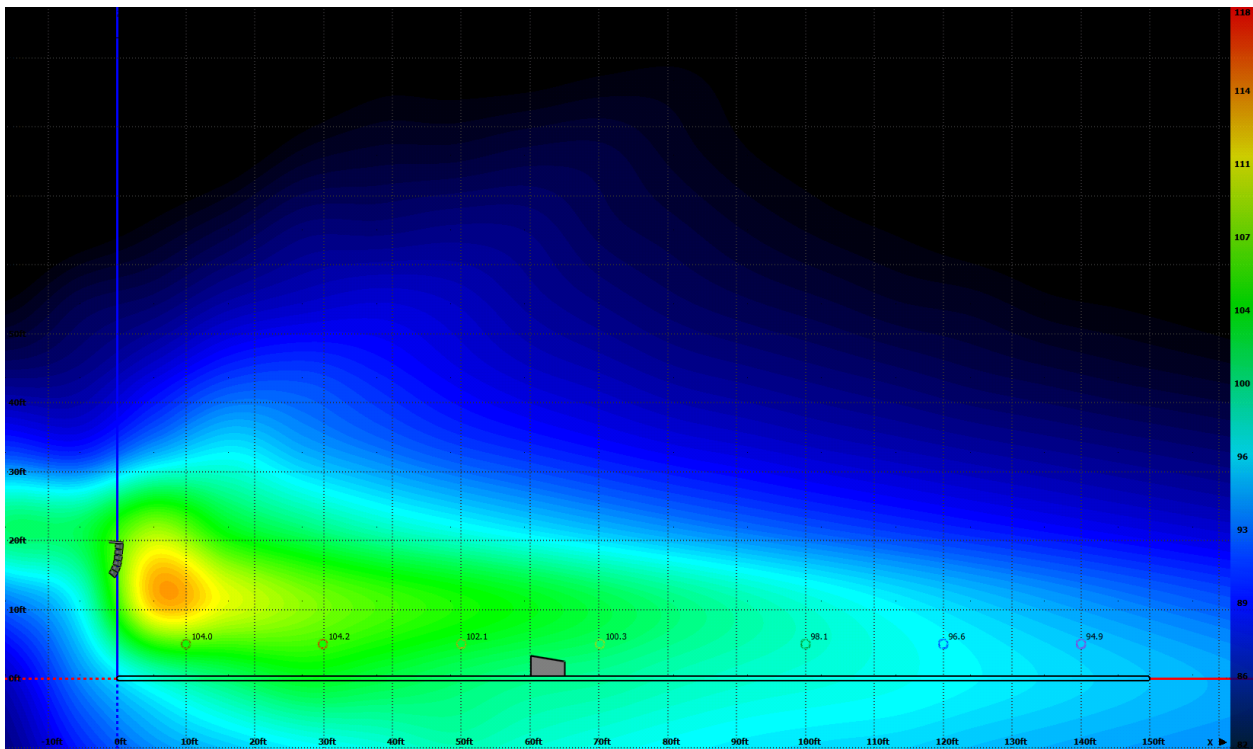

Flown Array, 200-foot Throw

With this configuration, coverage is extended as far as 200 feet while maintaining a low trim height and weight. For yet greater flow, trim height could be increased, or a delay system could be added. The addition of RSX12 subwoofers into the flown array (combined with increased trim height) will further increase low-mid-frequency consistency.

Equipment:	(8) RSX208L per cluster
Max Audience Distance:	200 feet/60 meters
Trim Height:	18 feet/5.5 meters
Continuous SPL:	105 – 94 dBA from 30ft/9m to 200ft/62.5m
Rigging Configuration:	Flybar @ position 5 Splays: 0 (RSX208L #1-flybar), 0, 0, 3, 3, 6, 9, 12
Total System Weight:	360 lbs/163 kg

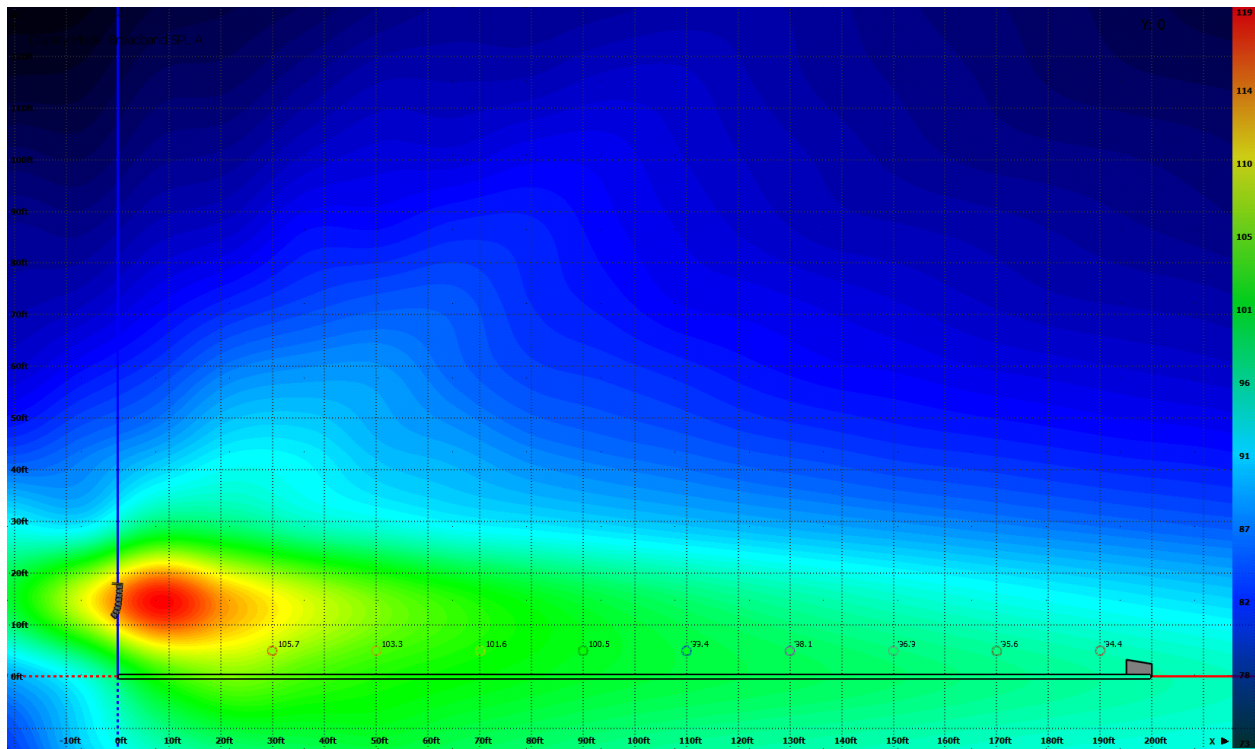

Troubleshooting

In the unlikely event of any issues with your RADIUS system, refer to the below symptoms and potential resolutions. If none of these apply, please contact EAW's Application Support Group for assistance (contact information on next page).

Symptom	Possible Cause	Potential Resolution
After updating firmware from Mosaic, cannot connect to loudspeakers on network and/or rear panel display does not return to normal operating mode.	Loudspeaker has not rebooted after firmware update.	Reboot loudspeaker (via AC power cycle).
Cannot connect to one or more loudspeakers on network from Mosaic.	Faulty network connection(s) within system.	Examine the rear-panel Ethernet link indicator on the loudspeakers in question. Verify Ethernet connectivity by selectively disconnecting Ethernet cables (if network loop-through is being used) to verify that all connections are being made.
Cannot connect to <i>any</i> loudspeakers on network from Mosaic.	Faulty or non-existent connection between iPad and wireless router, or between router and loudspeakers.	Verify that iPad is logged into wireless router. Connect to router via laptop running Audinate Dante Controller and verify that loudspeakers appear. If they do not, verify IP address settings and DHCP status on router.
Network loudspeaker discovery is sluggish or unreliable.	Wireless router is saturated with network audio traffic. Network is handling significant unrelated traffic.	Ensure that wireless router is connected to a filtered port (labeled "COMM") on one of the loudspeaker enclosures (or a Mackie DL32R). This will reduce the amount of additional traffic sent to the router, improving Mosaic performance. Ensure that the RADIUS network is isolated from corporate or office networks, or those handling internet traffic.
RADIUS loudspeaker does not sound 'correct'.	User-defined processing parameters remain in system, degrading performance from factory standards.	Perform Factory Reset via loudspeaker rear panel. NOTE: This will not affect Dante audio assignments or names.

Service, Inspection & Maintenance

General Service

All components in the RADIUS system are designed to withstand the most rigorous and demanding environments. Through regular operation it may still be necessary to replace acoustical, electronic and mechanical components.

Contacting EAW

We have attempted to make this manual and the as thorough as possible. However, feel free to contact us with any further questions or comments for topics not covered.

Operating Questions

EAW Applications Support Group

Tel 508-234-6158 x 2

Tel 800-992-5013 x 2 (USA only)

Fax 508-234-6479

E-mail asg@eaw.com

Service Information

EAW Service Department

Shipping

One Main Street Building 9

Whitinsville, MA 01588 USA

Tel 508-234-6158 x 3

Tel 800-992-5013 x 3 (USA only)

Fax 508-234-3776

E-mail service@eaw.com

General

Eastern Acoustic Works

One Main Street

Whitinsville, MA 01588 USA

Tel 508-234-6158

Tel 800-992-5013 (USA only)

Fax 508-234-6479

Web <http://www.eaw.com>

E-mail info@eaw.com



RADIUS™



www.eaw.com

©2016 LOUD Technologies Inc. EAW is a registered trademark of LOUD Technologies Inc in the U.S.A. and all other countries.

All other trademarks referenced herein are the property of their respective owners. All rights reserved.

All terms, conditions, and specifications subject to change without notice.

RD0969 (A)