

Reamp Station

DIRECT BOX & STUDIO REAMPER



User Guide

Radial Engineering Ltd.
1165-1845 Kingsway Ave, Port Coquitlam
British Columbia, Canada, V3C 1S9
Tel: 604-942-1001 • www.radialeng.com
Email: info@radialeng.com

Radial® Reamp Station User Guide

Table of Contents	Page
Overview.....	1
Features	2-3
Using the Direct Box.....	4-6
Using the JCR Reamper.....	6-10
Linking multiple Reampers	10
Rack mounting the Reamp Station.....	11
Specifications	12
Warranty	Back cover

Thank you for purchasing the Radial Reamp Station, a combination high-performance active direct box and studio Reamper in one. With the Reamp Station, you can not only record pristine direct tracks, you can also Reamp them through your guitar pedals and amplifiers to have a powerful effect on your mixes.

We recommend you take a few minutes to read this short manual before you begin using the Reamp Station, as it covers the various features of the device and tips for setup and use. Should you have any questions about the Reamp Station or any other Radial devices, please visit our website at www.radialeng.com for additional resources and frequently asked questions.

OVERVIEW

Capturing great recordings of your instruments and using those tracks for later Reamping go hand in hand, and finally there is one professional studio device that can handle both tasks equally well. The Reamp Station combines two products that Radial is well-known for: a direct box to feed guitars, basses, and other instrument signals to a recording interface or mixer, and a Reamper which allows you to take line-level signals from pre-recorded tracks and feed them through guitar amps and pedals for creative experimentation and to improve your mixes. Whether you are new to the Reamping process or you've been doing it for years, the Reamp Station will help you perform the recording and Reamping steps with ease while maintaining superior audio integrity throughout the entire process.

The two circuits within the Reamp Station (the D.I. and the Reamper) operate independently from one another, so you can use them one at a time or simultaneously as described later on in this user guide. To simplify things, we will describe how to use each set of features in the order that you are likely to encounter them in a typical recording session - starting with the direct box, and then the Reamper.

Direct Box Features

Reamper Features



The Ground Lift is the only shared feature between the two circuits

FEATURES - FRONT PANEL



DIRECT BOX FEATURES

1. **INSTRUMENT INPUT:** 1/4" unbalanced input is used to connect your instrument to the Reamp Station.
2. **THRU OUT:** 1/4" unbalanced output passes your instrument signal through to a guitar amplifier for local monitoring or recording.
3. **BUFFER:** Activates a signal buffer on the THRU output to avoid loading down passive pickups when connecting to a guitar amp.
4. **PAD:** -15dB pad reduces the input sensitivity of the direct box for connection to high-output instruments like an active bass guitar.
5. **48V INDICATOR:** Illuminates when the Reamp Station is receiving phantom power in order to operate the direct box features. Note that power is not required for any of the Reamper features.

REAMPER FEATURES

6. **MUTE:** Cuts signal to the 1/4" AMP OUT connection.
7. **FILTER:** Three position switch applies a high-cut, low-cut, or flat frequency response to the 1/4" AMP OUT connection to tailor the Reamped tone as needed.
8. **LEVEL:** Controls the signal level to the 1/4" AMP OUT connection for optimal gain-staging through guitar pedals and amplifiers.
9. **3.5MM INPUT:** Allows mobile devices to connect to the Reamp Station and feed amplifiers and guitar pedals. Automatically sums left and right channels to mono.

FEATURES - BACK PANEL

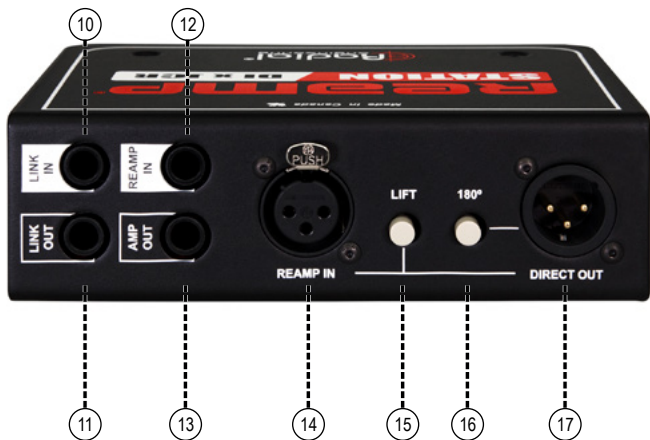

REAMPER FEATURES

10. **LINK IN:** 1/4" TRS connector is wired in parallel with the balanced 1/4" REAMP IN, allowing multiple Reamp devices to be daisy-chained together to feed a single source to multiple amplifiers.
11. **LINK OUT:** 1/4" TRS connector feeds a copy of the balanced audio source to another Reamp device or an outboard effects processor.
12. **REAMP IN:** Balanced 1/4" TRS input for connection to the line-level output of a recording interface or mixer.
13. **AMP OUT:** 1/4" unbalanced output to feed a Reamped signal to guitar pedals and amplifiers.
14. **REAMP IN:** Balanced locking XLR input for connection to the line-level output of a recording interface or mixer.
15. **GROUND LIFT:** Disconnects the internal ground path at the Reamp inputs and the Direct output to help eliminate hum and buzz from ground loops. This feature is shared between the direct box and the Reamper sides of the device, but it does not require power to function.

DIRECT BOX FEATURES

16. **180°:** Reverses the polarity at the Direct Output to reduce phase cancellation when the D.I. is combined with a mic'd up amplifier.
17. **DIRECT OUTPUT:** Balanced XLR output for connection to the mic-level input on a recording interface or mixer.

USING THE DIRECT BOX

The first step when Reamping in the studio is recording your original 'clean' track, which is what the Direct Box (or D.I.) portion of the Reamp Station is designed to do. A D.I. takes the unbalanced, high-impedance, instrument-level signal from your instrument, and converts it to a balanced, low-impedance, microphone-level signal that is optimized for connection to an audio interface for recording.

Performing musicians take note that the D.I. in the Reamp Station is equally well suited for use on a live stage: instead of connecting to an audio interface as described below, the D.I. output would feed the FOH console or a PA system.

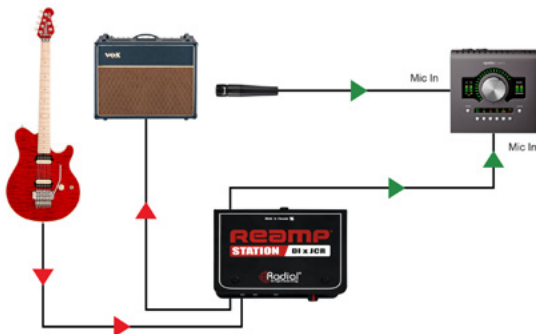

Recording your instrument with the Reamp Station

Connecting to your instrument and amplifier

The front panel INST jack allows you to connect to any instrument you wish to record, while the THRU output will feed that same signal to a guitar or bass amp for local monitoring or for simultaneous recording with a microphone.



The front panel D.I. features

These connections use standard 1/4" TS instrument cables, and we recommend that you use short cables (under 15ft) to minimize the possibility of noise and interference on your audio signal.

Connecting to an audio interface & powering the DI

The rear panel DIRECT OUT sends a balanced mic-level signal to your audio interface for recording. Use an XLR mic cable to connect this output to the microphone preamp input on your interface.



The rear panel D.I. features

You can use cables up to 300ft in length without noticeable interference or signal degradation, which allows the Reamp Station to be placed right next to the instrumentalist in the studio, even if that's in a remote iso booth.

The Reamp Station uses an active D.I. circuit, which means it needs power in order to operate. Once you have made the XLR connection on the D.I., engage 48V phantom power on that channel of the audio interface - it will often be labeled as simply '48V'. Once the D.I. is receiving power, the front panel 48V LED will illuminate within seconds and stay lit to provide visual confirmation that the direct box features are ready for use.

The Buffer and Pad switches

Two front panel switches are provided for the D.I. section. The BUFFER switch engages a FET-based buffer circuit on the THRU output. This is beneficial for instruments with passive pickups, which are susceptible to changes in tone when they are 'loaded down' through connections to multiple devices.



The Buffer and Pad switches

Without the buffer, your instrument will be affected by the total load impedance presented by both the D.I. and a connected amplifier. When the buffer is engaged, your instrument only sees the impedance of the D.I., and the original tone of your pickups will be preserved.

Note that if you have an instrument with active pickups, or if you use buffered guitar pedals anywhere in the signal chain, this switch will likely have no audible effect. Wait 60 seconds after powering the D.I. with 48V before activating the BUFFER switch, as it takes a short amount of time to charge before it is ready for use.

The PAD switch reduces the input sensitivity of the D.I. by 15dB. This prevents high output instruments such as active basses and keyboards from overloading the input stage of the D.I. Start with this switch disengaged, and activate if needed should you hear any unexpected distortion or clipping.

The Lift and 180° Switches

The LIFT switch is a shared feature between the D.I. and the Reamper portions of the Reamp Station. It helps to eliminate buzz and hum from ground loops by disconnecting the audio ground path between the inputs and the outputs.



The Lift and 180° switches

If you encounter any additional noise after you've made your connections to the Reamp Station, simply engage the LIFT switch to help eliminate the issue.

The 180° switch reverses the polarity of the signal at the DIRECT OUT. This is provided to correct for phase cancellation that can occur when summing together a D.I. and a microphone placed on an amplifier. If you are recording the signal from your amp at the same time as the D.I., monitor both signals at once while toggling the 180° switch, then leave it at the setting that sounds best to your ears.

USING THE JCR REAMPER

The second step in the Reamping process is when the real fun begins. This is where you feed your recorded tracks back through your guitar pedals and amplifiers and record the results with a microphone. This allows you to experiment with different effects pedals, amplifiers, microphones and recording techniques, without requiring the guitar player repeat the performance each time.

In this step the JCR Reamper side of the Reamp Station is employed, which gets its name from the fact that it uses the original Reamp circuit designed by recording industry legend John Cuniberti. This circuit works by converting the balanced, low-impedance, line-level signal from your audio interface into an unbalanced, high-impedance, instrument-level signal that will give you the best results through your pedals and amps.

Unlike the D.I. portion of the Reamp Station, the Reamper section is completely passive, meaning it doesn't require any power to operate. As soon as you've made your connections it will be ready for use.



The JCR Reamper features on the Reamp Station

Connecting to your audio interface

The rear panel provides two options for connecting a balanced, line-level output from your audio interface to the Reamper section: both are labeled REAMP IN. You can use either the XLR or the 1/4" TRS input and get the exact same results, as both of these connector types are provided in order to make it easy to connect any audio interface to the Reamp Station without the need for adaptor cables.



The rear panel Reamp features

As described in the D.I. section of this manual, the LIFT switch can help eliminate buzz and hum from ground loops. If you encounter any additional noise after you've made your connections to the Reamp Station, simply engage this switch to help eliminate the issue.

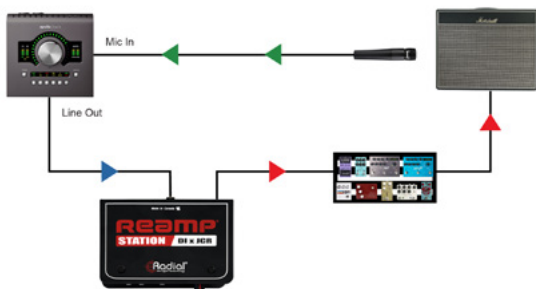

Reamping through pedals and an amp with the Reamp Station

Connecting to your pedals and amplifier

The AMP OUT jack provides an instrument-level, high-impedance, unbalanced signal that is optimized for connection to guitar pedals and amplifiers. Use a standard 1/4" TS instrument cable to connect this output to your pedalboard or feed your amplifier directly.

The final step after you've made your connections is to place a microphone on the amplifier and connect it to the mic input on your audio interface so you can record the results.

The Level control and gain-staging

The LEVEL control on the front panel sets the amount of attenuation applied to the signal before it feeds the AMP OUT for Reamping.



The Level control

This is useful because the line-level outputs on your audio interface are generally capable of producing higher signal levels than a pedal or amplifier is designed to accept. The LEVEL control allows you to reduce the output of the Reamp Station to prevent clipping or distorting the input of your amplifier.

The Reamp Station itself is capable of handling very hot input levels, so for best results you will want to provide as much output level as you can from your audio interface. Start by turning up the fader on the track you are using in your Digital Audio Workstation (DAW) until you have a healthy signal level just shy of clipping, then check any software associated with your interface itself to see if you have additional output level controls available.

Before you play any audio through the Reamper, start with the LEVEL control turned all the way down. Then begin playback from your DAW and slowly turn up this control until you've reached the desired output from your amplifier. Don't be afraid to turn the LEVEL control all the way up to the maximum setting if necessary: doing so will not increase the noise floor of the Reamper.

The Mute and Filter switches

Two front panel switches are provided to augment the output from the Reamper: A push button MUTE switch and a three-position FILTER selector switch.



The Mute and Filter switches

The MUTE switch cuts all signal to the AMP OUT jack, and it ensures that no signal will be played through your amplifier when you are adjusting the placement of a microphone (and have your ears mere inches from the speaker cabinet).

This switch also provides a handy way to listen for ground loop noise that can be eliminated with the LIFT switch, or for checking how much self-noise your amplifier is producing when it isn't receiving any input signal.

The Mute and Filter switches (continued)

The FILTER is a three-position toggle switch that gently rolls off the high or low frequencies at the AMP OUT, and it can also be bypassed for a completely flat frequency response. The upper setting on this switch activates a low-pass filter that reduces the high frequency content of the signal, which can be useful if you find that your amplifier sounds overly bright, or if you need to help a bass guitar track sit better in the mix.

The middle setting on this switch activates a high-pass filter which reduces the low frequencies of your Reamped signal. This can help clean up the sound of a muddy guitar track with excess low end resonance, and it can also be effective when used with heavily distorted tones. The bottom setting on this switch bypasses the FILTER altogether for a flat frequency response through the Reamper.

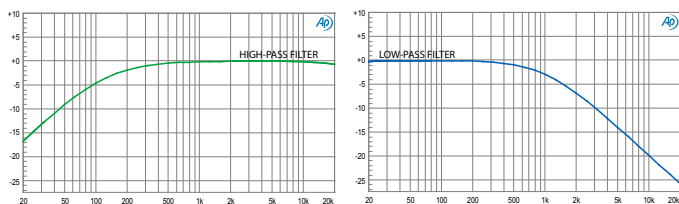

The frequency response of the high-pass and low-pass filters

The 3.5mm input

The 3.5mm INPUT allows you to easily connect a mobile playback device like a smartphone or a tablet to the Reamp Station. This makes it easy to audition new ideas on the fly, or even take the output of your favorite music making app and feed it through your amp for to create a unique effect.

Use a 3.5mm TRS cable to connect to this input: the Reamp Station will accept both the left and right outputs from your playback device and automatically sum them to a mono signal.



The 3.5mm Input

Note that the output from a mobile device will likely be somewhat lower than the line-level outputs of an audio interface, so you may need to adjust the LEVEL control and the gain on your amp to compensate.

The 3.5mm input (continued)

The 3.5mm input is on the front panel of the Reamp Station so you can connect quickly when inspiration strikes, instead of having to dig around behind your equipment rack should you have the Reamp Station rackmounted. However, keep in mind that you should only send signal to one of the Reamper inputs at any given time.

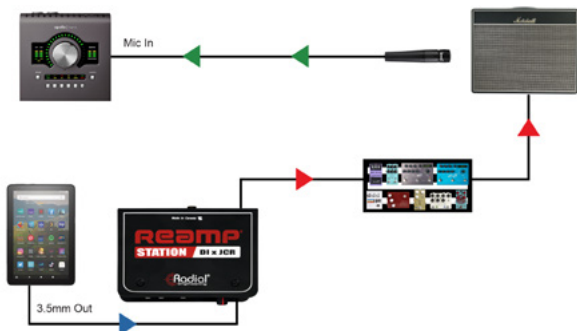

Reamping using a mobile device as the sound source

Linking multiple Reampers

The LINK IN and LINK OUT connections on the Reamp Station allow you to hook up multiple Reampers using a single output from your audio interface.

Use a balanced 1/4" TRS cable to connect from the LINK OUT on the first Reamp Station to the LINK IN or the REAMP IN on the second Reamper.

Repeat this step to link together additional Reamp Stations as needed.



Linking multiple Reampers

The LINK OUT carries a copy of the same balanced signal that you feed to the input of the Reamper, and it won't be affected by any of the controls on the Reamp Station. If your audio interface is short on line-level outputs, you can use this feature to feed a compressor on another outboard effects processor at the same time that you are Reamping with the Reamp Station.

Rack mounting the Reamp Station

Using the optional SA Series Rack Adaptor kit, you can easily mount the Reamp Station in standard 19" equipment racks for permanent installation. The SA Series kit allows you to mount either one or two devices in a single 1RU rackspace. *Part no R800 9422 00.*

Single unit rackmounting

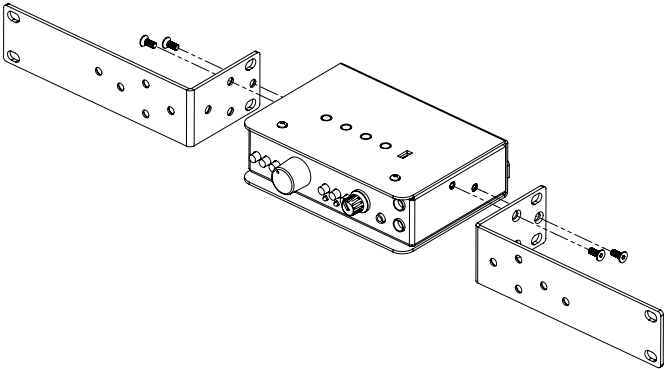

Double unit rackmounting

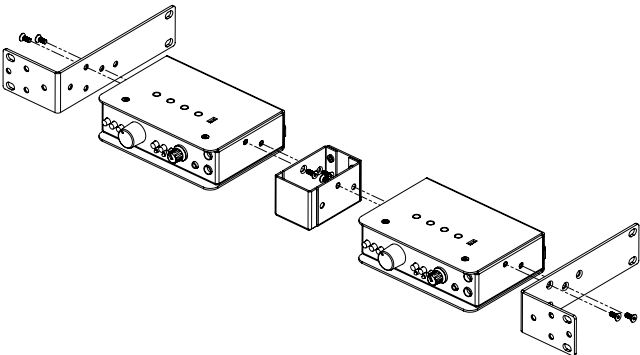

SPECIFICATIONS*

Direct Box

Audio Circuit Type:	Proprietary Active Circuit
Frequency Response:	5Hz to 20kHz (+/-0.5dB)
Total Harmonic Distortion:	0.004% @ 1kHz, 0dBu
THD + Noise:	0.004% @ 1kHz, 0dBu
Intermodulation Distortion:.....	0.005% @ -10dBV
Signal to Noise Ratio:.....	94dB
Dynamic Range:.....	100dB
Input Impedance:.....	220k Ω
Output Impedance:.....	185 Ω

JCR Reamp

Audio Circuit Type:	Passive, transformer based
Frequency Response:	0Hz to 20kHz (+/-0.5dB)
Total Harmonic Distortion:	0.002% @ 1kHz, +4dBu
THD + Noise:	0.005% @ 1kHz, +4dBu
Intermodulation Distortion:.....	0.001% @ 0dBV
Signal to Noise Ratio:.....	88dB
Dynamic Range:.....	100dB
Input Impedance:.....	1.4k Ω
Output Impedance:.....	5.1k Ω

Features

Input connections:	1/4", XLR, 3.5mm
LED Indicators:.....	48V phantom (Direct box only)
Output Connectors:	1/4", XLR
Mounting Options:	SA series rack mount kit available

General

Power:	48V phantom power (Direct box features only)
Construction:	14-gauge Steel Chassis & Outer Shell
Finish:	Durable Powder Coat

* Subject to change without notice.

THREE YEAR TRANSFERABLE LIMITED WARRANTY

RADIAL ENGINEERING LTD. ("Radial") warrants this product to be free from defects in material and workmanship and will remedy any such defects free of charge according to the terms of this warranty. Radial will repair or replace (at its option) any defective component(s) of this product (excluding finish and wear and tear on components under normal use) for a period of three (3) years from the original date of purchase. In the event that a particular product is no longer available, Radial reserves the right to replace the product with a similar product of equal or greater value. In the unlikely event that a defect is uncovered, please call 604-942-1001 or email support@radialeng.com to obtain an RA number (Return Authorization number) before the 3 year warranty period expires. The product must be returned prepaid in the original shipping container (or equivalent) to Radial or to an authorized Radial repair centre and you must assume the risk of loss or damage. A copy of the original invoice showing date of purchase and the dealer name must accompany any request for work to be performed under this limited and transferable warranty. This warranty shall not apply if the product has been damaged due to abuse, misuse, misapplication, accident or as a result of service or modification by any other than an authorized Radial repair center.

THERE ARE NO EXPRESSED WARRANTIES OTHER THAN THOSE ON THE FACE HEREOF AND DESCRIBED ABOVE. NO WARRANTIES WHETHER EXPRESSED OR IMPLIED, INCLUDING BUT NOT LIMITED TO, ANY IMPLIED WARRANTIES OF MERCHANTABILITY OR FITNESS FOR A PARTICULAR PURPOSE SHALL EXTEND BEYOND THE RESPECTIVE WARRANTY PERIOD DESCRIBED ABOVE OF THREE YEARS. RADIAL SHALL NOT BE RESPONSIBLE OR LIABLE FOR ANY SPECIAL, INCIDENTAL OR CONSEQUENTIAL DAMAGES OR LOSS ARISING FROM THE USE OF THIS PRODUCT. THIS WARRANTY GIVES YOU SPECIFIC LEGAL RIGHTS, AND YOU MAY ALSO HAVE OTHER RIGHTS, WHICH MAY VARY DEPENDING ON WHERE YOU LIVE AND WHERE THE PRODUCT WAS PURCHASED.

To meet the requirements of California Proposition 65, it is our responsibility to inform you of the following:

WARNING: This product contains chemicals known to the State of California to cause cancer, birth defects or other reproductive harm.

Please take proper care when handling and consult local government regulations before discarding.



Made in Canada 

www.radialeng.com

Radial Engineering Ltd.

1165-1845 Kingsway Ave, Port Coquitlam, British Columbia, V3C 1S9

Tel: 604-942-1001 • www.radialeng.com • info@radialeng.com

Radial® Reamp Station User Guide - Part #: R870 1071 00 / 07-2022

Copyright 2022 Radial Engineering Ltd. All rights reserved.

Specifications and appearance subject to change without notice.

