

# DiGiCo S21 User Guide

Version E for Software Version 1.1



## EC DECLARATION OF CONFORMITY

This is to certify that the:

**DIGICO S21 MIXING CONSOLE**

From serial number 210010

Manufactured by:

**DIGICO (UK) LIMITED  
UNIT 10  
SILVERGLADE BUSINESS PARK  
LEATHERHEAD ROAD  
CHESSINGTON SURREY  
KT9 2QL  
UNITED KINGDOM  
TEL: (+ +44) 01372 845 600  
FAX: (+ +44) 01372 845 656**

Conforms with the protection requirements of the Council Directive's 2004/108/EC and 2006/95/EC, relating to Electromagnetic Compatibility and Low Voltage Directive by the application of the following standards:

**EN55103-1 2009 Emission standard  
EN55103-2 2009 Immunity standard  
EN60065 2002 A1 2006 Low voltage directive**

Signed:   
John Robert Stadius

Position: Technical Director

Date: 24<sup>TH</sup> MARCH 2015

## Copyright © 2016 Digico UK Ltd

### All rights reserved.

No part of this publication may be reproduced, transmitted, transcribed, stored in a retrieval system, or translated into any language in any form by any means without the written permission of Digico UK Ltd. Information in this manual is subject to change without notice, and does not represent a commitment on the part of the vendor. Digico UK Ltd shall not be liable for any loss or damage whatsoever arising from the use of information or any error contained in this manual.

### Software License Notice

Your license agreement with Digico UK Ltd, which is included with the S21 console product, specifies the permitted and prohibited uses of the product. Any unauthorised duplication or use of Digico UK Ltd software, in whole or in part, in print or in any other storage and retrieval system is prohibited.

### Licenses and Trademarks

The S21 logo and S21 name are trademarks. Digico UK Ltd and the Digico UK Ltd logo are registered trademarks of Digico UK Ltd.

Digico (UK) Ltd  
 Unit 10  
 Silverglade Business Park  
 Leatherhead Road  
 Chessington  
 Surrey  
 KT9 2QL  
 England  
 Telephone: +44 (0)1372 845600  
 Fax: +44 (0)1372 845656  
 Email: sales@digiconsoles.com  
 WWW: http://www.digico.biz

### Manual Issue and Date: Issue E - January 2016 - For Version 1.1

### Software Licence Agreement

"**Product**": S-Series software product produced by Digico UK Ltd intended for use on Target Platform identified below.

"**Target Platform**": Digico S-Series Digital Console systems.

In return for the payment of the one-time fee, the Customer (identified at the end of this Agreement) receives from Digico UK Ltd a licence to use the Product subject to the following terms and conditions.

1. The Product may be used without time limit by the Customer on the Target Platform.
2. The Customer must register the Product with Digico UK Ltd. Registering the Product is deemed an acceptance of the terms and conditions in this agreement.
3. The Product and its licence are not transferable, and the Customer is not permitted to onward-license to any third party. The Customer indemnifies Digico UK Ltd against any and all claims and actions arising from third party use of copies of the Product made by the Customer.
4. The Customer agrees not to attempt to decompile the object code of the Product otherwise than in circumstances specifically provided for by law, and then only after consultation with Digico UK Ltd.
5. The Customer agrees not to use, or licence the Product for use, with equipment other than the Target Platform.
6. The Customer agrees not to modify the Product without the prior written consent of Digico UK Ltd.
7. This Agreement applies to any enhancement or upgrades that may become available for the Product.
8. This Agreement does not transfer any right, title, or interest in the Product to Customer except as specifically set forth herein.
9. Digico UK Ltd reserves the right to terminate this Agreement upon breach, in which event Customer shall thereafter only be authorised to use the Product to the extent that its contractual commitments to third parties require and then only where such commitments relate to use of the Product as authorised in the foregoing provisions of the Agreement.

**LIMITED WARRANTY** - Digico UK Ltd warrants for a period of 1 year from the date of purchase of the Product, the Product will reasonably execute its programming instructions when properly installed on the Target Platform. In the event that this Product fails to execute its programming instructions during the warranty period, the Customer's remedy shall be to return the Product to Digico UK Ltd for replacement or repair at Digico UK Ltd option. Digico UK Ltd makes no other express warranty, whether written or oral with respect of this Product.

**LIMITATION OF LIABILITY** - Except as otherwise expressly provided by law, (a) the remedies provided above are the Customer's sole and exclusive remedies and (b) Digico UK Ltd shall not be liable for any direct, indirect, special, incidental, or consequential damages (including lost profit whether based on warranty, contract, tort, or any other legal theory.)

This agreement is made under the Laws of England.

**LICENCE NO:** .....

**REGISTRATION DATE:** .....

# Contents

<b>1.1 The Console .....</b>	<b>1-1</b>
<b>1.2 Before You Start .....</b>	<b>1-2</b>
1.2.1 Worksurface Layout.....	1-2
1.2.2 Layers and Banks.....	1-3
1.2.3 Using the Control Surface .....	1-3
1.2.4 The Selected Channel .....	1-4
1.2.5 The Under Screen Controls.....	1-4
<b>1.3 The Expanded Views.....</b>	<b>1-5</b>
1.3.1 Display Expanded Views .....	1-5
1.3.2 Channel Setup View .....	1-6
1.3.3 Copy Channel .....	1-7
1.3.4 Recording & Virtual Soundcheck.....	1-8
1.3.5 Group and Aux Setup View.....	1-9
1.3.6 Aux Sends View .....	1-11
1.3.7 Input Routing View .....	1-12
1.3.8 EQ View .....	1-13
1.3.9 Dynamics 1 View .....	1-14
1.3.10 Dynamics 2 View .....	1-15
1.3.11 Control Group Setup .....	1-16
1.3.12 Solo Channel Setup.....	1-17
<b>1.4 Customising the Layout.....</b>	<b>1-18</b>
1.4.1 The Console Overview .....	1-18
1.4.2 The Spill Set .....	1-18
1.4.3 Swap Banks .....	1-19
1.4.4 Set Master .....	1-19



---

<b>1.5 The Main Menu.....</b>	<b>1-20</b>
1.5.1 Session Management.....	1-20
1.5.2 Snapshots .....	1-21
1.5.3 Preferences .....	1-24
1.5.4 Audio Sync.....	1-24
1.5.5 Macros .....	1-25
1.5.6 FX Rack .....	1-25
1.5.7 Graphic EQs.....	1-27
1.5.8 Send & Return Insert Routing .....	1-28
1.5.9 Matrix.....	1-28
1.5.10 System.....	1-29
1.5.11 Diagnostics .....	1-30
1.5.12 Restart or Shutdown .....	1-30
1.5.13 Upgrading Software .....	1-31
<b>2.1 DMI Cards.....</b>	<b>2-1</b>
2.1.2 Fitting DMI Cards.....	2-1
<b>2.2 MADi DMI Cards.....</b>	<b>2-2</b>
2.2.1 Connecting MADi DMI.....	2-2
2.2.2 Sharing Racks with MADi DMI.....	2-5
2.2.3 Auto-Discovery of DMI Cards & Racks.....	2-7
2.2.4 DMI Card Details & Upgrade.....	2-8
<b>2.3 DMI-DANTE Cards .....</b>	<b>2-9</b>
<b>2.4 DMI - ADC - DAC - AES Cards .....</b>	<b>2-10</b>

## 1.1 The Console

The Digico S21 consists of a worksurface, an audio engine and a range of onboard inputs and outputs. It can be connected using optional DiGiCo DMI Cards to a variety of DiGiCo racks and other audio input/output devices.

The console worksurface consists of 2 sections that can be configured to control up to 40 mono or stereo input channels, 10 VCAs, 16 mono or stereo busses plus a Master buss and a 10 Input x 8 Output Matrix.

The left and right sections have 10 assignable faders and 10 sets of assignable on-screen channel controls, the right hand section also has a dedicated Master fader and mute, a Master/Solo meter, a set of 6 assignable encoder/switches and worksurface navigation controls

The console's buss architecture is dynamic, and can support mono and stereo configurations.

Multiple console setups can provide:

Front of House and Monitoring with shared stage racks and gain tracking.



## 1.2 Before You Start

There are certain general operating principles and terms that should be understood before continuing to use this manual. Please read this chapter carefully before proceeding.

**IMPORTANT NOTES:**

*S21 V1.1 software is not compatible with any sessions created in preliminary (pre V1.0) versions of software*

*It is compatible with sessions created in V1.0 or V1.0.1*

*Please delete old sessions (pre 1.0) to avoid potential issues and create a "New" session in V1.1.*

*The console power switch is situated on the rear panel.*

*Please ensure that any required DiGiCo I/O racks are connected to the console DMI cards and powered on before starting the console itself to enable automatic discovery of the racks.*

*DMI cards are NOT "Hot swappable" so please ensure that the console is powered off before inserting or removing them.*

*We recommend that the first snapshot is used as a "Setup" Snapshot where all of your "session wide" settings like routing, Control Group membership and Buss Modes (whether Busses are Groups or Auxes) are first stored. Because these types of setting can be changed with Snapshot recall, it is advisable to save them all into this first snapshot before creating any further Snapshots. In this way, the settings for all subsequent Snapshots will contain the same data and there should be less requirement to adjust the Safe settings in the channels.*

### 1.2.1 Worksurface Layout .....

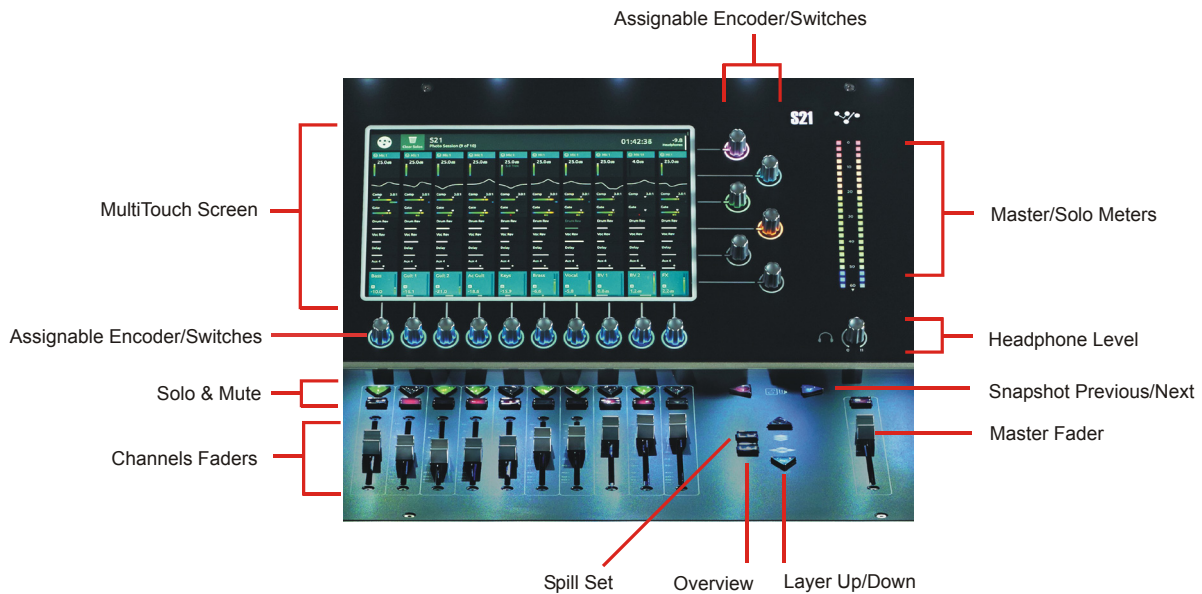

### Rear Panel

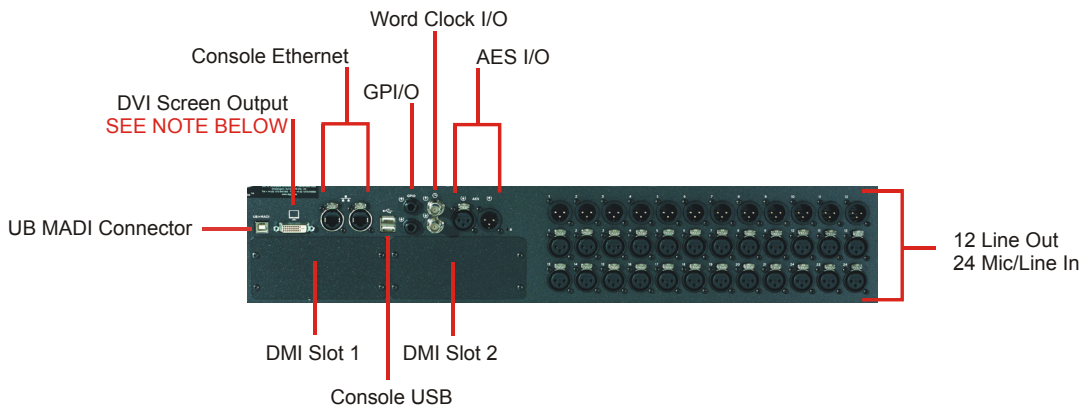

**IMPORTANT NOTE:** The DVI Screen output will display a copy of the Master (right hand) screen but this must be connected to the HDMI input of a suitable monitor using a standard DVI to HDMI adaptor (not supplied).

**IMPORTANT NOTE:** The GPI/O functionality is not yet implemented in V1.1

### 1.2.2 Layers and Banks.....

The S21's worksurface is divided into Layers and Banks. Each Layer contains 2 Banks of 10 channels, and the layer which is currently active on the control surface is selected using the **layer up and down** buttons next to the Master fader.

The **right hand screen** is referred to as the **Master Screen** and this is where the various expanded views of elements such as EQ and Dynamics are displayed.

Pressing the white **Overview** button, located near the **layer up and down** buttons displays an on screen representation of all console channels and the active layer can also be selected by touching it on the screen in this mode. The specific channels which are contained within each Bank are defined in the **Overview** display. By default, the Input channels will be assigned to Layers 1 and 2 on the left and right sections of the console.

The different output channels will be assigned to Layer 3 and 4. Control Groups will also be assigned to Layer 4. These bank assignments can be customised by the user and saved in a session at any time.

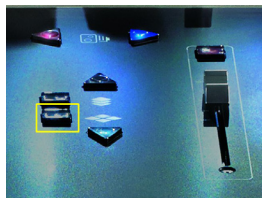

### 1.2.3 Using the Control Surface .....

There are two main ways in which all of the functions of the S21 are accessed:

1. The touchscreen display, which can be controlled directly using a finger
2. The physical encoders, switches and faders.

A number of functions can be accessed in different ways, allowing users to operate the console using whichever interface they prefer. All of the physical controls on the console worksurface are described in full within the relevant section of the manual and many require no further introduction.

The right hand Master Screen has a DiGiCo logo icon at the top which is used to access the **Main Menu**

Main Menu

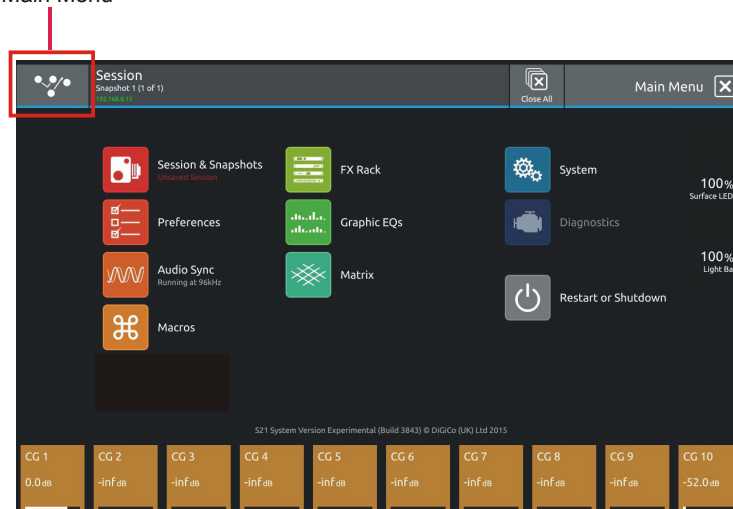

## 1.2.4 The Selected Channel .....

One of the channels in the Channel view is displayed with a highlighted background, indicating that it is currently the Selected Channel. This means that it has been assigned to the worksurface controls to the right of the screen as shown in the image below. To assign a channel, touch in the Output Block at the bottom of the on screen Channel view

**NOTE: All of the master and under screen rotaries are encoders and switches in one unit.**  
**Often, different functions can be accessed by a standard turn, a push turn and a push (switch)**  
**eg Standard turn = Gain control & Push turn = Trim control**

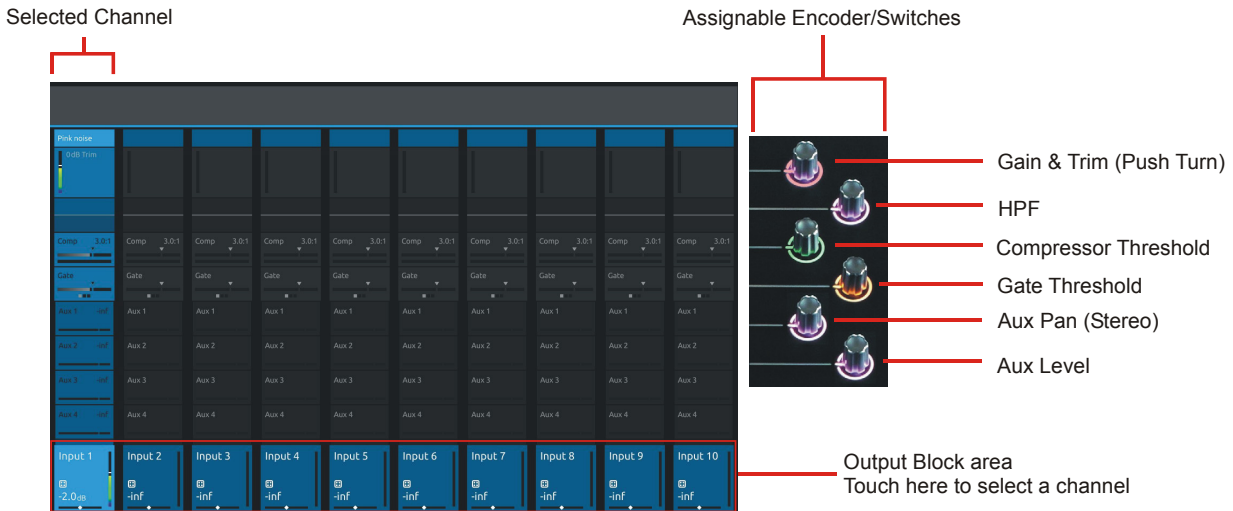

**NOTE: When the right hand screen is not displaying the Channel view (eg it is displaying an EQ view), the master screen worksurface rotaries will not be assigned to the Channel view controls but to the controls for the EQ or other expanded view instead.**

## 1.2.5 The Under Screen Controls .....

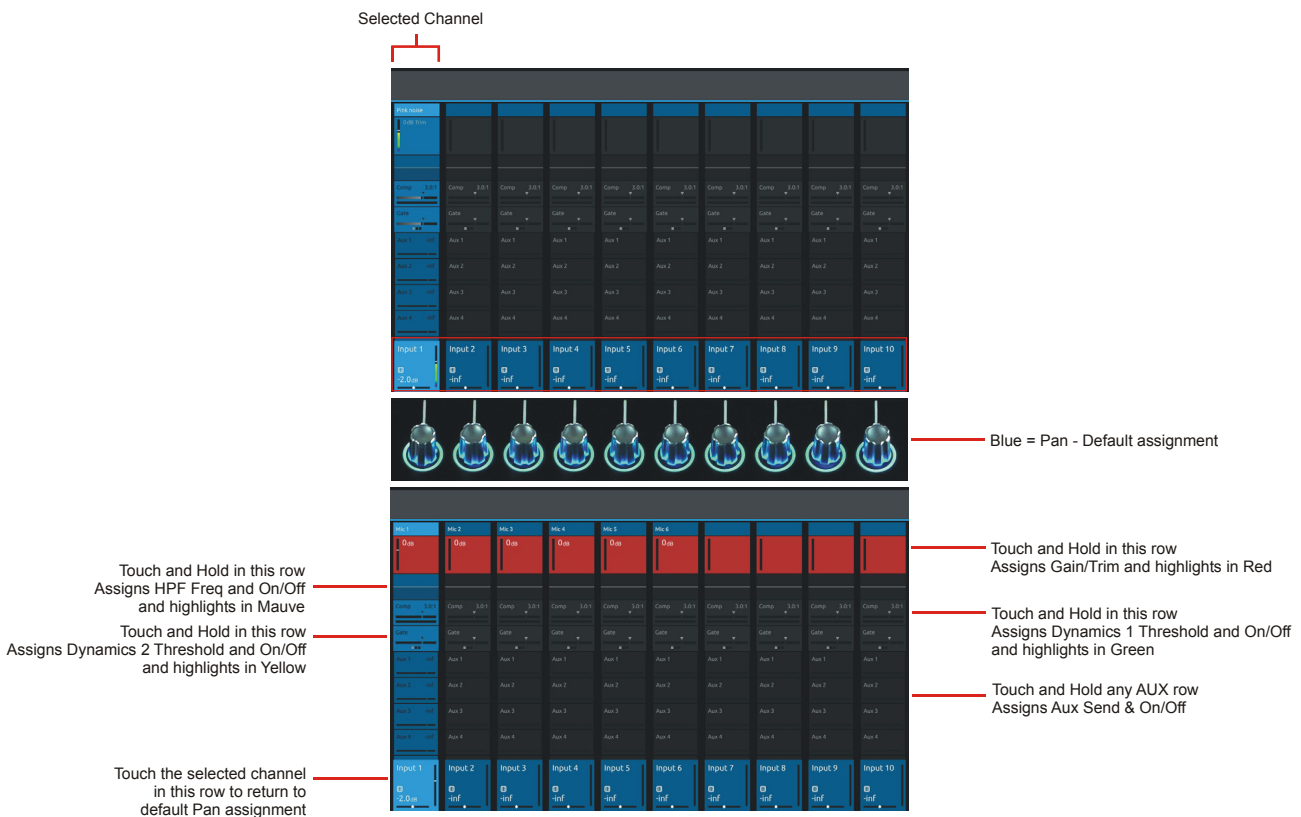

There is a row of 10 encoder/switches immediately below each touchscreen (shown above) that refer to the channels with which they are aligned.

These controls give access to the channel pans in standard operation and the surrounding coloured LED rings are blue. Touching and holding on the rows of controls on screen assign these encoders to different parameters, the screen row changes colour and the LED rings change to a similar colour.

In the above example the Gain/Trim row at the top of the Channel View has been touched, the row is highlighted in red and the under-screen controls are assigned to the Gain/Trim function.

Other possible assignments are:

- HPF Frequency & On/Off - Row and LED ring highlighted in Mauve
- Dynamics 1 Threshold & On/Off - Row and LED ring highlighted in Green
- Dynamics 2 Threshold & On/Off - Row and LED ring highlighted in Yellow
- Selected Aux row Send level & On/Off - Row and LED ring highlighted in Purple

### 1.3 The Expanded Views

#### 1.3.1 Display Expanded Views .....

A single touch (rather than a touch and hold) will open a number of different expanded views according to where the touch is made.



The image above shows the various touch areas in the Channel view and the expanded view will be displayed on the Master screen.

**Note: When an expanded view is already open, selecting a different channel by touching the Output block area at the bottom of the screen will change the expanded view to display the newly selected channel.**

**If an expanded view is already open and a different expanded view is selected, the last view selected will be displayed on the Master screen with the previously expanded view behind it.**

**Any combination of expanded views can be "layered" in this way.**

The **Close All** button on the Master screen can be touched at any time to close all active expanded views. The **Close** button on the Master screen can be touched at any time to close the currently active expanded view and display the view beneath it.

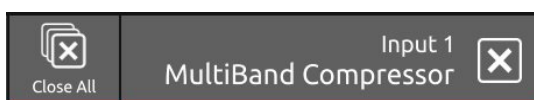



1.3.2 Channel Setup View .....

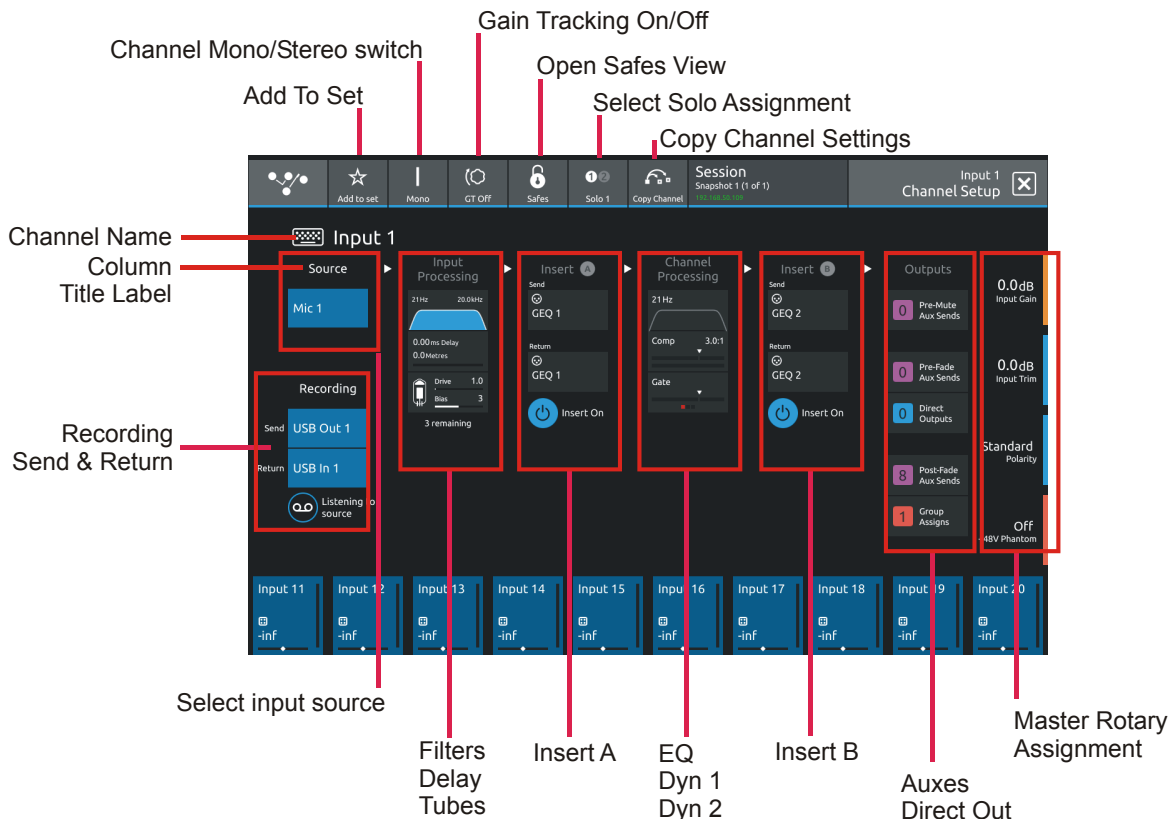

Touching the input block at the top of the channel opens the Channel Setup view  
 Each column represents a section of the channel processing strip and these columns can be selected by touching their title label.  
 Once a column is selected, the parameters available in that section are assigned to the worksurface Master Rotaries to the right of the screen.  
 Some columns are subdivided into blocks eg Input processing consists of Filters, Delays and Tubes.  
 Touching any of these blocks will assign the Master Rotaries to the settings for that block.  
 Note that touching the Filter block or the EQ block will both display the EQ view but with different bands selected.

**Note: When any expanded view is open on the Master screen, the Master Rotaries no longer have their standard default assignment and are instead assigned to the parameters in the expanded view which is currently displayed.**

- The buttons in the top bar provide the following functions:
- Switching the channel from **Mono to Stereo mode**
  - Adding the channel to a **Spill Set** (see Spill Set section later in this document)
  - Switching **Gain Tracking On/Off** for the channel
  - Opening the **Safes View** which allows channel parameters to be protected from Snapshot Recall
  - Selecting which **Solo** Busses the channels are assigned to

- Touch the **keyboard icon** at the top left of the screen to enter a channel name.
- Touch the **Equaliser** button at the bottom left of the screen to switch to the EQ view for the currently selected channel.
- To select an **Input Route** touch the block below the **Source** label and the Input routing view will open.
- To select an **Output Route** touch the **Direct Output** block in the **Outputs** column and the output routing view will open.
- To assign the channel to a **Group buss** touch the **Group Assigns** button in the **Outputs** column
- To view and adjust **Aux Send Options** for the channel touch the relevant **Aux Sends** button in the **Outputs** column

### 1.3.3 Copy Channel .....

Multiple settings can be copied from one channel to single or multiple other channels using the Copy Channel button in the Channel setup view

Open the **Channel Setup** view for the required source channel by touching the top of its channel strip

Touch the **Copy Channel** button in the top bar

Touch to select or deselect the parameters that you wish to copy - selected blocks will be highlighted in green

To select/deselect all of the channel parameters that can be copied touch the **Full Copy** button in the top bar

Touch the **Copy** button in the bottom right of the screen

Select the Destination channel(s) by touching them on screen - they will have a white outline

Touch the **OK** button in the bottom right of the screen



**NOTE:** Insert and Output routes cannot be copied as they could cause conflicts with existing routes  
 Not all parameter types exist for all channel types so some options might be unavailable  
 eg Buss mode on an input channel



## 1.3.4 Recording & Virtual Soundcheck.....

Any input channel can be sent from a dedicated pre-processing **Record Send** point in the channel signal path to any valid output socket.

Typically a selection of input channel signals would be sent to the console's UB MADI interface for recording on a DAW via a USB connection.

Playback signals from the DAW can be returned into the dedicated **Record Return** and switched either individually or globally to replace the standard input signal to that channel. This is known as **Listening to Copied Audio**.

Listen to sources  
&  
Listen to copied audio  
Macros

### Record Send and Return Routing

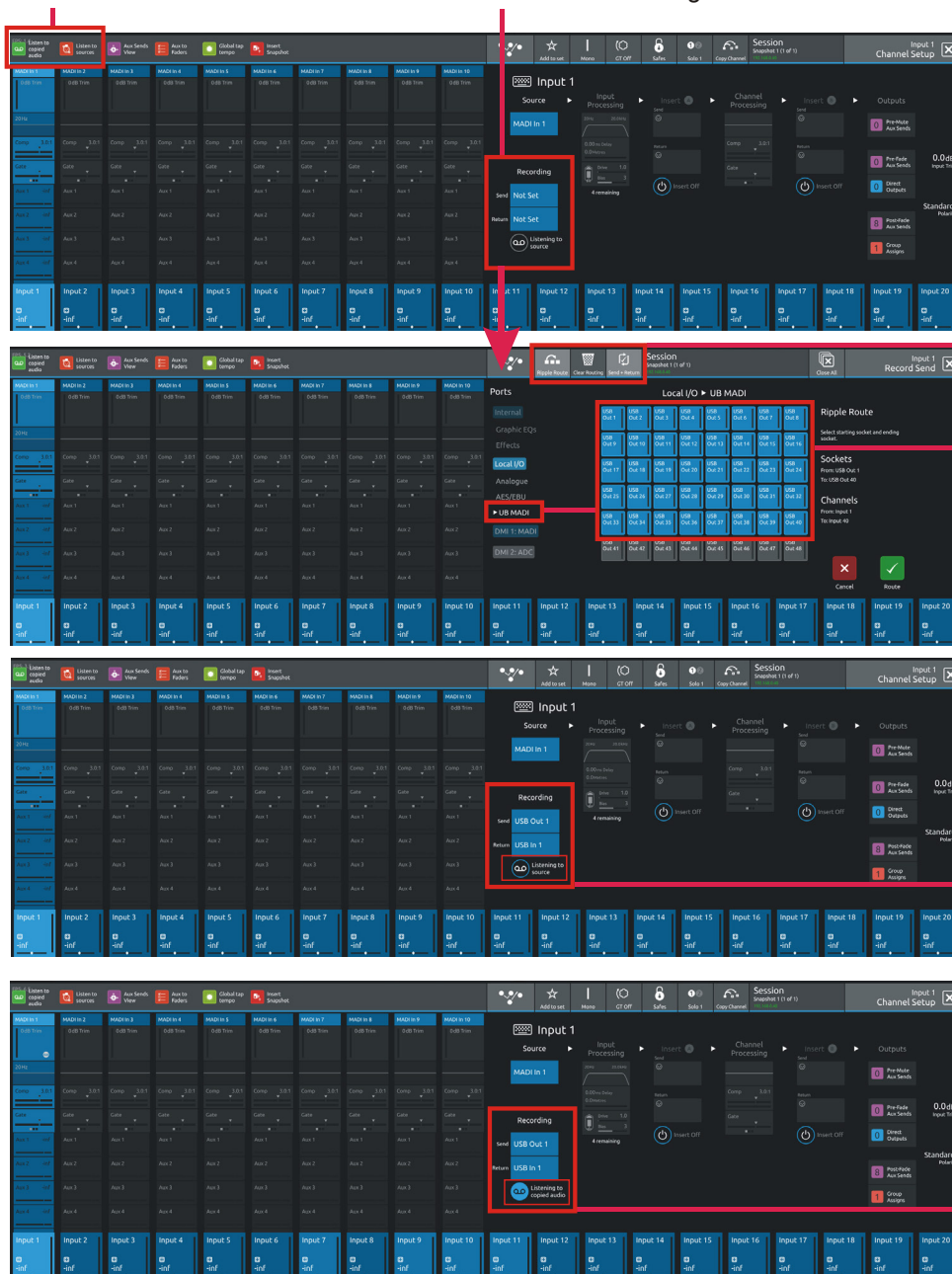

Ripple Route with Send+Return Active

Record Sends to 40 x UB MADI Outputs

Listening To Source

Listening To Copied Audio

### To set up a Record Send and Return:

- 1) Touch the top of the first input channel that you wish to record to open the Channel Setup View
  - 2) Touch the Recording Send button on the left of the screen to display the Record Send Routing view
  - 3) Ensure that the Send+Return mode is active using the button in the top bar
  - 4) Select an output to feed the recorder by first selecting a port (eg UB MADI) and then a socket from that port (eg USB OUT 1)
- Multiple channel Record Sends can be assigned at the same time using the standard Ripple Route function

- 5) When the Record Send selections have been made, touch the Route button at the bottom right of the screen to confirm.
- 6) Select the Channel Setup View again and you will note that the relevant, same numbered input route for the Record Return has automatically been assigned. So if your Record Send was USB Out 1 then your Record Return will be USB In 1
- 7) The button below the Record Send & Return has 2 states:
  - a) **Listening to Source** - the Record signal is being sent and the channel signal is the original Record Send source
  - b) **Listening to Copied Audio** - The Record signal is being sent and the channel signal is the Record Return from the recording device eg Playback signal

**NOTE: There are 2 Macros available that allow switching of all console Record Sends from Listen to Sources to Listen to Copied Audio. Using these 2 Macros, the console can be set to monitor record source or record returns globally for all channels that are being recorded.**

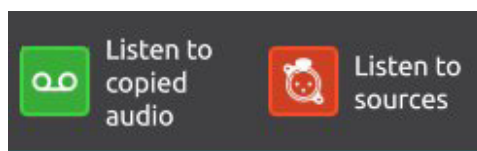

Record Sends and Returns do not have to use the console UB MADI Port, they can use any port or combination of ports in any socket order required. For example, a recording could be made via a MADI DMI card.

A Record Send can be routed to multiple destinations at the same time but a Record Return can only be fed from one input socket at one time. This is the input socket that will be used when Listen To Copied Audio is active.

### 1.3.5 Group and Aux Setup View.....

The Group and Aux Channel Setup view are very similar to the Input Channel version but they have one extra function that is used to convert a Group Buss to an Aux Buss or vice versa

The S21 has a fixed number of output busses but they can be changed at any time to be either Auxes or Groups.

In the example below, touching the **Mode** button on the Group Setup view will change the Group to an Aux but there is warning that all channel assignments will be reset in the process. So the newly converted Aux will be flattened.

The situation is exactly the same when converting an Aux to a Group - all assignments are reset

**Note: In S21 V1.1, Aux/Group Buss Mode can be changed with a Snapshot recall which has its own Safe block. Please ensure that the buss modes are set in your first Snapshot before you create any further Snapshots. This will ensure that the buss mode settings will be consistent in all Snapshots.**

Change Group to Aux

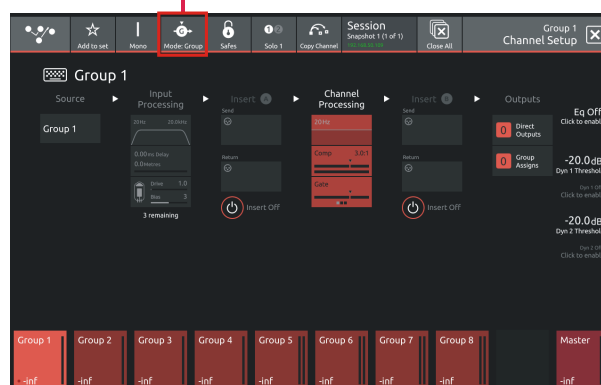

Warning

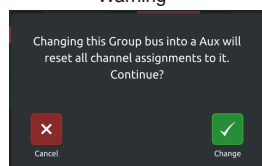

## Group To Group Routing

Any mono or stereo Group buss can be assigned to any other buss (including the Master buss) using the **Group Assigns** view on a Group channel.

Touch the top of a Group channel to open the Channel Setup view, touch the Outputs column and then touch the Group Assigns button. In the example below, Group 1 is assigned to the Master buss by touching the Master buss button.

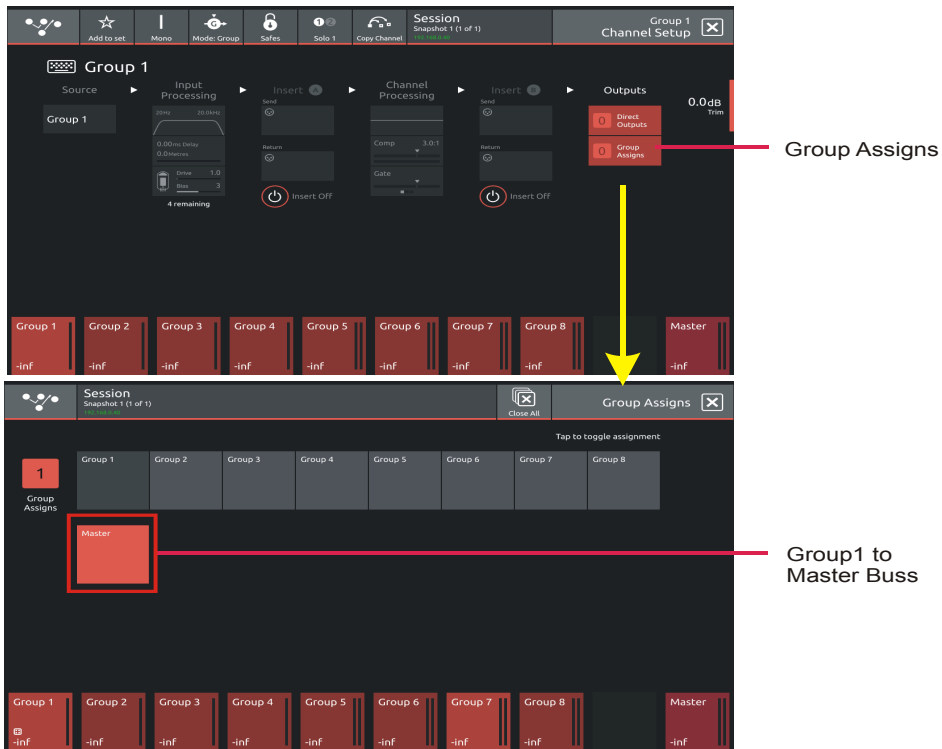

**NOTE: A Group cannot be assigned to itself**

## Aux Send Pre/Post Switches

Any Aux buss can have all of its related sends from all channels set to Pre/Pre-Mute/Post using the buttons in the Aux buss setup view. Touch the top of an Aux channel to open the Channel Setup view and then touch the relevant **Set All Sends To** button on the right of the screen. A warning will be displayed which can be confirmed by touching the **Yes** button.

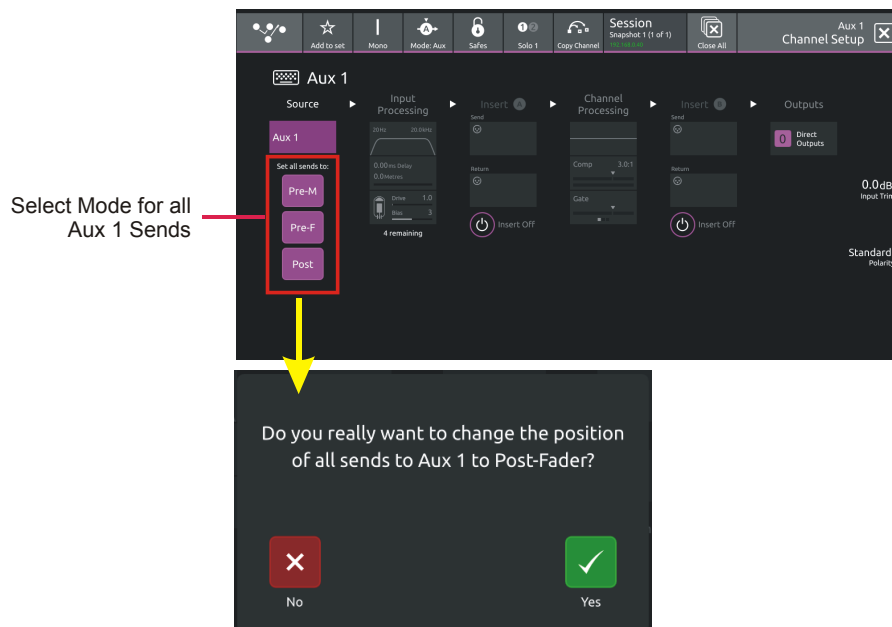

### 1.3.6 Aux Sends View .....

The **Aux Sends View** panel displays every aux buss in the current session and touching the buss will activate the buss solo and aux to faders.

It can be accessed from any input channel's setup view by selecting the outputs column and touching one of the Aux Sends buttons or from the **Aux Sends View Macro**.

There are 2 options in the top bar:

- 1) **Solo on select** - with this option active, the relevant Aux Master Solo will be activated
- 2) **Assign on select** - with this option active, the relevant Aux buss sends will be assigned to either the input channel faders or the underscreen rotaries according to the status of the Aux To Faders option in the Preferences panel.

If **Aux To Faders is OFF** the sends are assigned to the underscreen rotaries

If **Aux To Faders is ON** the sends are assigned to the channel faders

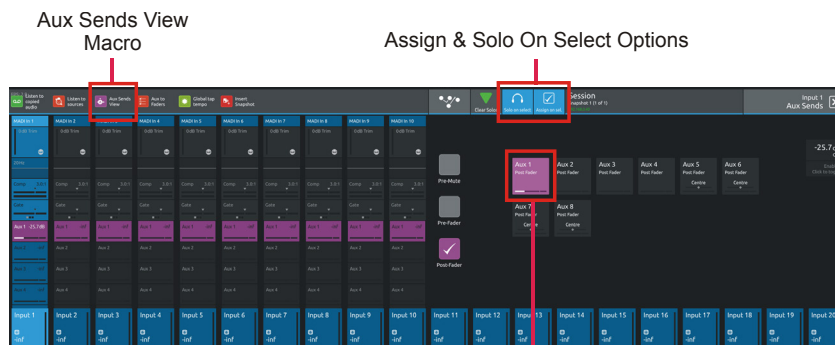

Select Aux Buss

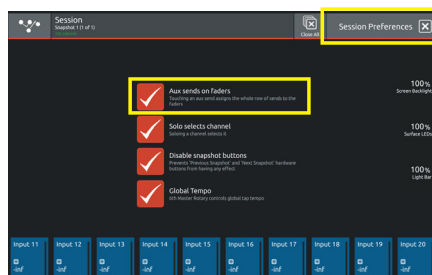

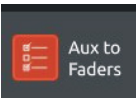
OR  
  
 Aux to Faders On/Off Macro

### 1.3.7 Input Routing View

Touching the **Source** area on the Channel Setup will open the **Input Route** expanded view. Only input channels have a **Source** selection - output channels sources are fixed within the system. To select an input source, touch one of the buttons in the port list on the left of the screen and the relevant sockets will be displayed. Now touch to select a socket in the socket display. Inputs can be routed into multiple channels at the same time using the **Ripple Route** function. Touch the Ripple Route button in the top bar and then select the first and last sockets in the required range - then press the **OK** button. The Master Rotaries are assigned to the Gain/Trim, +48V and Input Pad controls if they exist for the socket type selected.

**Note: Ripple routes are automatically done in the channel display order rather than channel number order.**

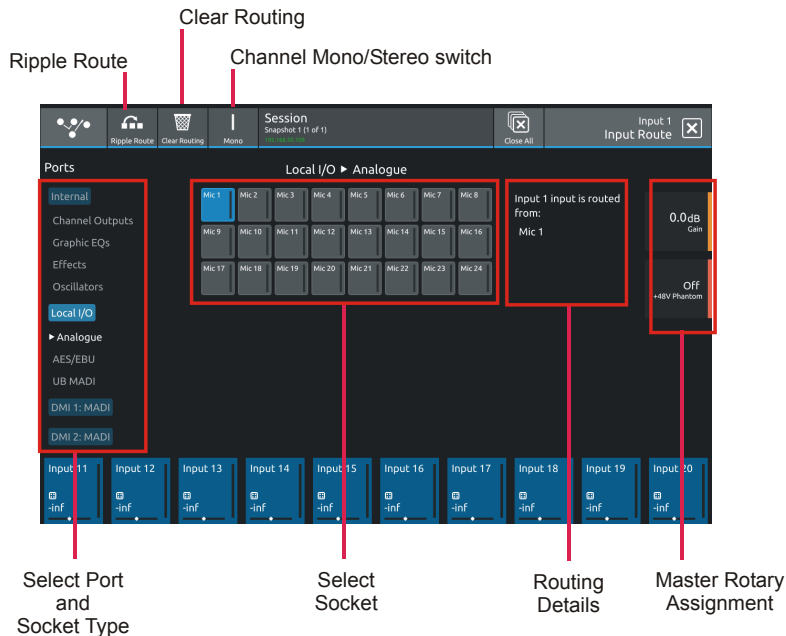

#### Clear Routing

Multiple consecutive socket routes (inputs routing or outputs) can be cleared using the **Clear Routing** function. From any input or output routing view, select the relevant port by touching the port name in the left hand column. Touch the **Clear Routing** button in the top bar. Select the first and last sockets in the range that you wish to clear. Touch the **Clear** button at the bottom right of the panel. In the example below DMI 1 MADi Port - Input Sockets 1-8 will be cleared.

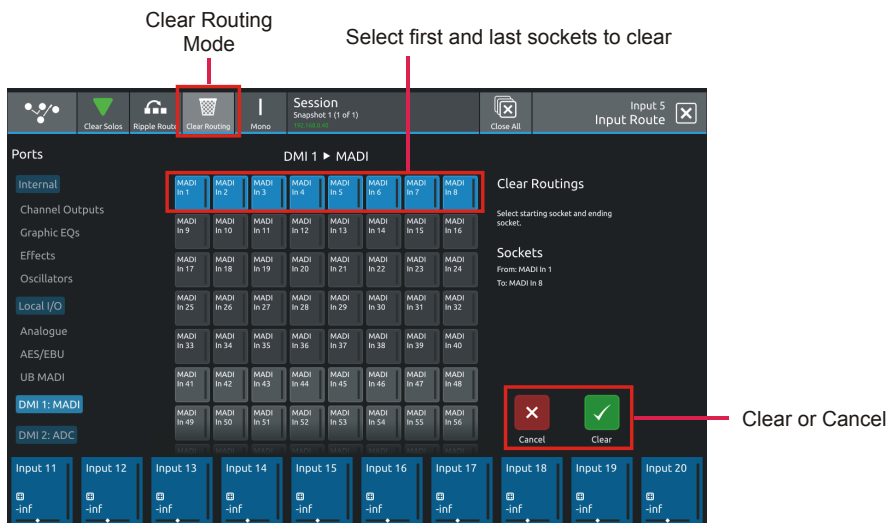

**NOTE: Sockets routings are cleared in socket order, not in channel order, so in the above example, the sockets that are cleared may not necessarily belong to adjacent channels. The input routing will be cleared from ANY channel that has these sockets as an input source. This is not a channel Clear Routing function but rather a socket Clear Routing function**

### 1.3.8 EQ View .....

Touching the EQ area on either the Channel view or the Channel Setup will open the EQ expanded view.

The EQ band can be selected by touching the band icons on the left of the screen or by touching the bands on the EQ graph itself.

The graph has 2 modes, 4 band EQ or filters. Touch the relevant band and the adjust the parameters by dragging the band icon on the graph.

While an EQ band is selected, it can be "pinched" on screen to adjust the Q setting.

The selected band's parameters can also be adjusted with the Master Rotaries to the right of the screen

The buttons in the top bar provide the following functions:

**EQ On/Off**

**Copy EQ** to another channel(s) - touch the button and select the destination channels from the channel picker - OK to confirm

**Flatten EQ**



## 1.3.9 Dynamics 1 View .....

Touching the Dynamics 1 area on either the Channel view or the Channel Setup will open the Dynamics 1 expanded view. Dynamics 1 can be a Single Band or Multiband Compressor (on 4 channels). Touch the **Mode** button in the top bar to switch modes. Multiband Dynamics has **4 viewing modes**, one for each individual band and one that displays all 3 bands at the same time. These are selected with the buttons on the left of the screen.

Parameters can be adjusted on-screen or using the Master Rotaries to the right of the screen. The buttons in the top bar also provide the following functions:

### Dynamics Module On/Off

**Copy Dynamics settings** to another channel(s) - touch the button and select the destination channels from the channel picker - OK to confirm

### Reset Dynamics module

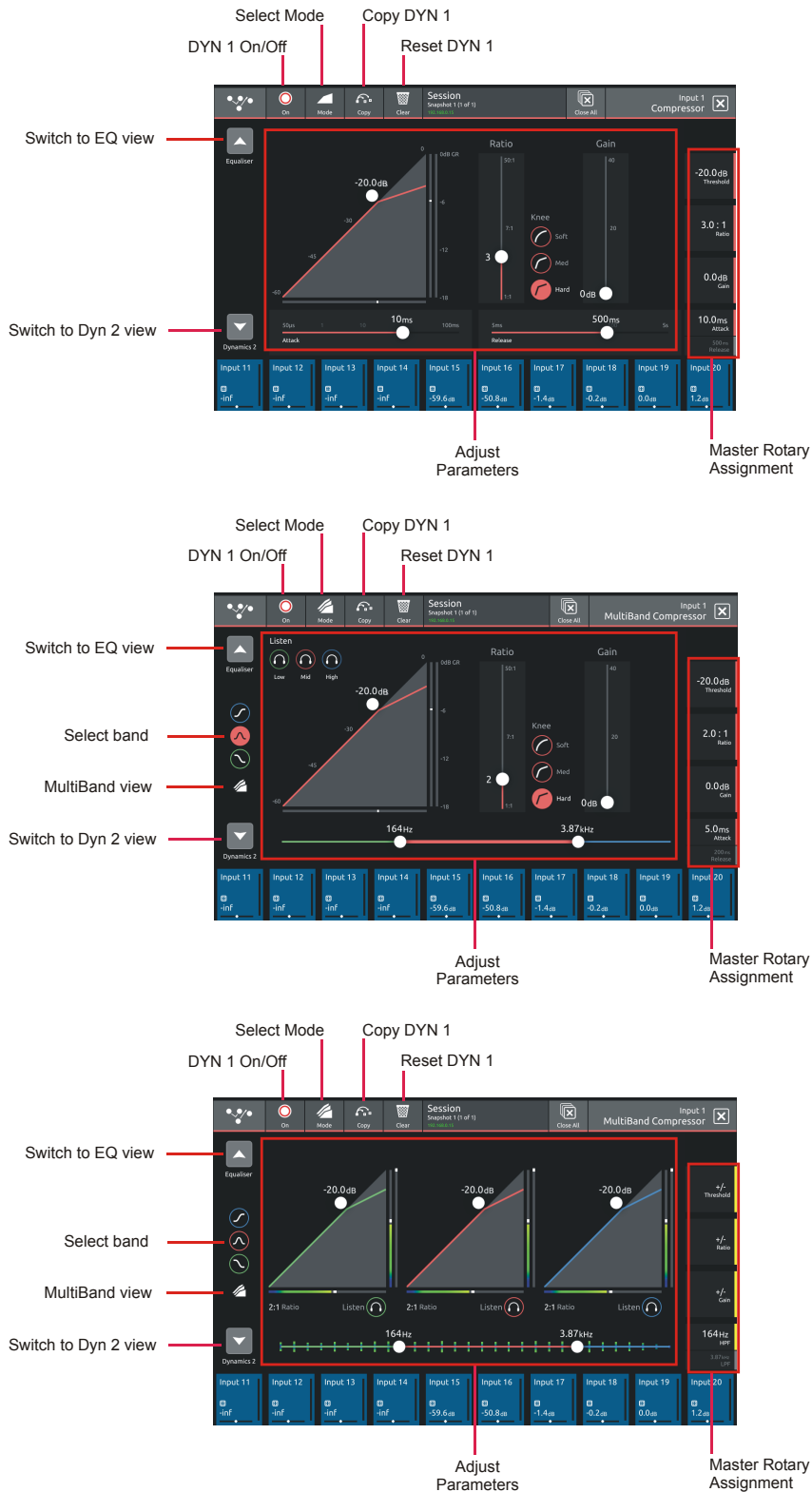

### 1.3.10 Dynamics 2 View .....

Touching the Dynamics 2 area on either the Channel view or the Channel Setup will open the Dynamics 2 expanded view.

Dynamics 2 can be a Keyed Gate, a Ducker or Single Band Compressor with Side Chain.

Touch the **Mode** button in the top bar to switch modes.

Dynamics module 2 provides side chain access via a selectable input - this can be used for external triggering.

Select the Source signal by touching the **Key/Side Chain input** button on the left of the screen and select a source from the standard input routing list. Then use the **Self/Ext** button to activate this function.

Parameters can be adjusted on-screen or using the Master Rotaries to the right of the screen.

The buttons in the top bar also provide the following functions:

**Dynamics Module On/Off**

**Copy Dynamics settings** to another channel(s) - touch the button and select the destination channels from the channel picker - OK to confirm

**Reset Dynamics module**

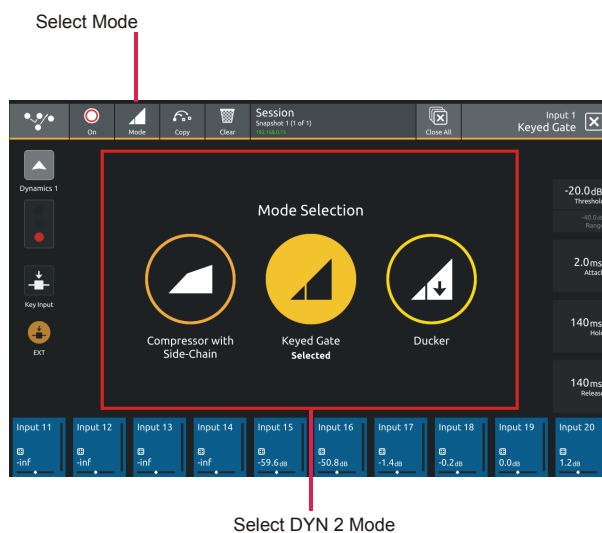
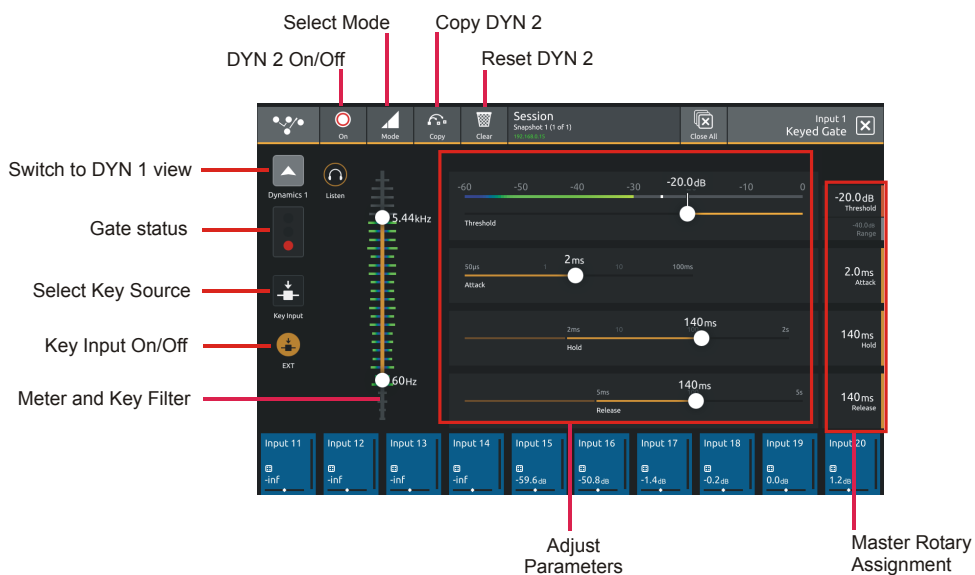



## 1.3.11 Control Group Setup .....

To create a Control Group, touch the top of a **Control Group Channel** to open the CG Setup view

Touch the **Edit** button in the top bar

Select the required CG members by touching them in the **Channel Picker** and touch the OK button

The CG Setup view will now show blocks representing each of the CG members and the CG channel will display a list of its members with their fader levels

Setup CG



### 1.3.12 Solo Channel Setup.....

The S21 has 2 Solo busses which have their own control channels in the console layout normally located on the 4th layer next to the Matrix Output channels.

**Note: Both Solo busses 1&2 are both sent permanently to the console headphone socket.  
When no channels are soloed, the Master Bus (No Solo source) will always be sent to Solo Bus 1**

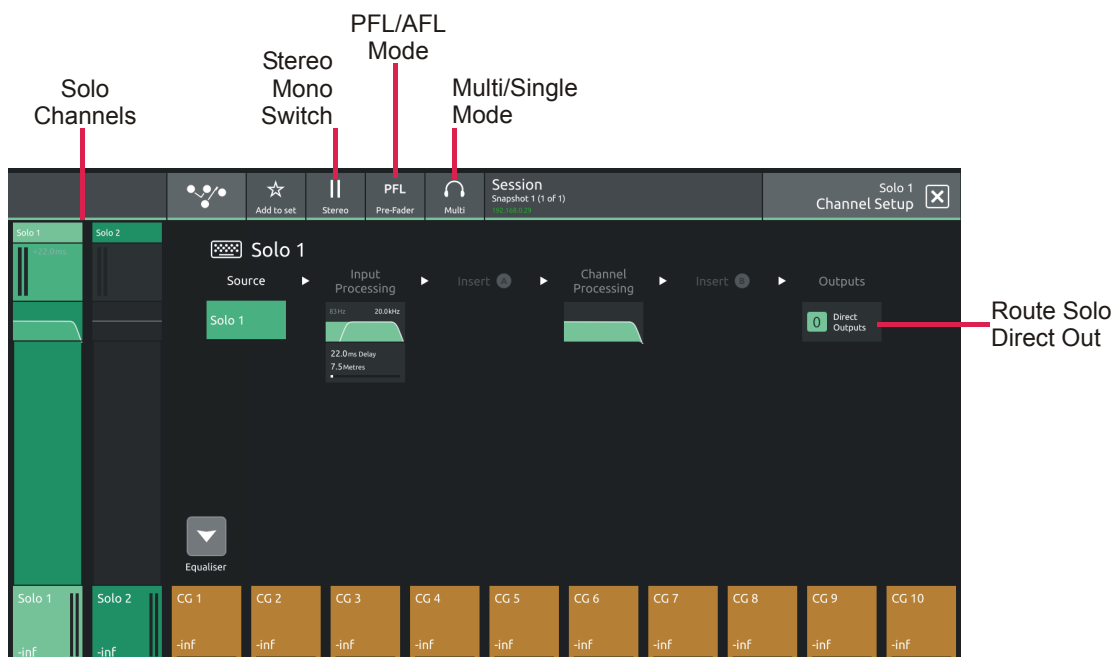

Touching the top of either Solo channel will open the relevant Solo setup view

Various Solo buss settings can be found in the top bar of this view

Solo busses can be switched **Mono or Stereo**

They can be set to **PFL or AFL** mode

They can be set to **Multi Mode** where multiple solos can be switched on at the same time or **Single Mode** where switching one solo on will cancel previously active Solos

Any channel can be assigned to **Solo Buss 1, 2 or both 1&2.**

Open the channel setup view for any channel and there is a Solo buss assignment button in the top bar.

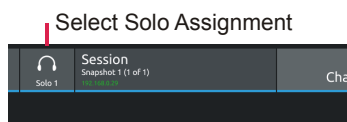

## 1.4 Customising the Layout

### 1.4.1 The Console Overview

Pressing the white **Overview** button, located near the **layer up and down** buttons displays an on screen representation of all console channels. This view can be used to change the layout of the console channels and banks.

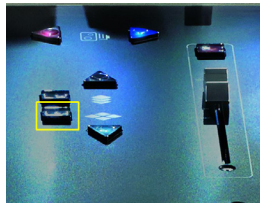

Touching the **Edit** button in the top bar changes the appearance of the display and activates drag and drop capability. Any block that represents a channel can be dragged to another position and dropped there. This will overwrite the channel in that position and the overwritten channel will reappear in the **Unassigned Channels** section at the bottom of the left screen.

Channel blocks can also be dragged directly to the Unassigned Channels section to remove them from the worksurface

**Note: Channel blocks can be dragged between the 2 console screens**

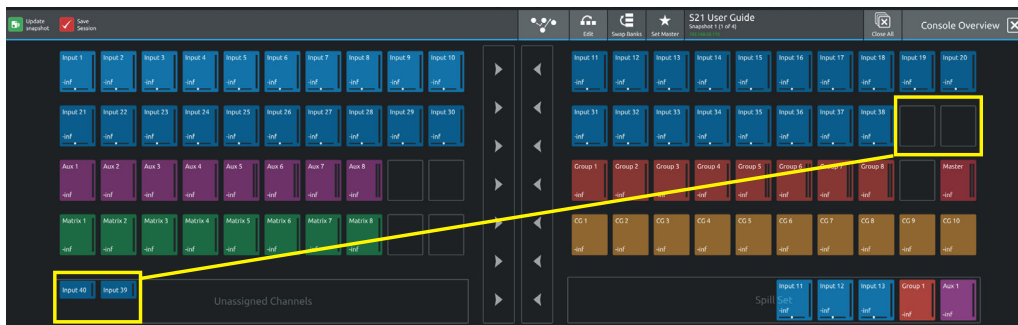

### 1.4.2 The Spill Set

In Edit mode, a selection of up to 10 channels can be dragged to the **Spill Set** section at the bottom of the right hand overview screen to create a Spill Set.

Typically, these would be channels to which the user needs to have quick access at all times.

When a Spill Set has been created, the worksurface button located above the overview button will become blue and pressing this button will display the Spill Set channels on the right hand screen. pressing again hides the Spill Set.

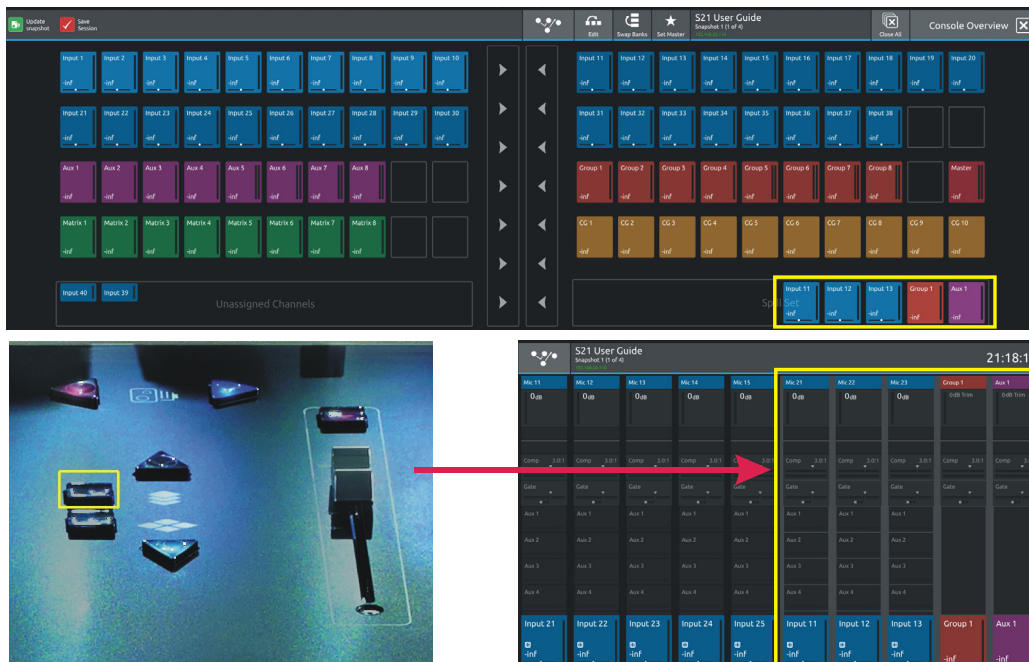

### 1.4.3 Swap Banks

In Edit mode, touching the **Swap Banks** button in the top bar allows complete banks to be moved from one position to another either from left to right or from one layer to another.

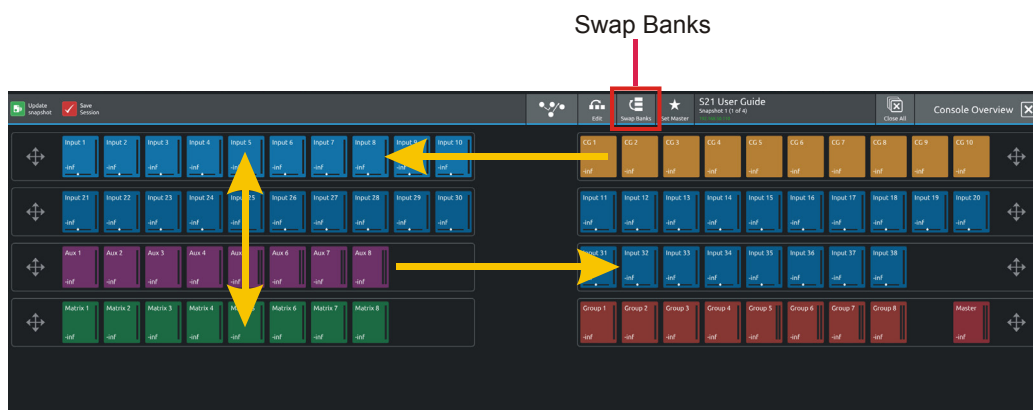

### 1.4.4 Set Master

In Edit mode, touching the **Set Master** button in the top bar allows a bank to be selected that will be locked to the right hand console screen. Press the Set Master button and then touch the required bank.

In this mode, all other banks are assigned to the left hand console screen and can be accessed using the worksurface layer up and down buttons. Once a Master is set, it can be cleared by touching the **Clear Master** button in the top bar.

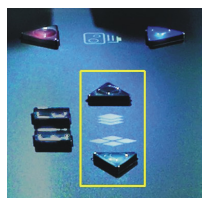

Set Master / Clear Master

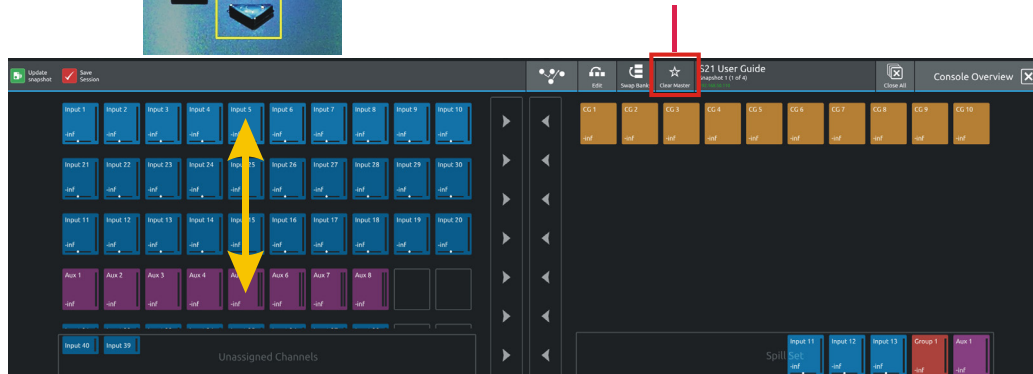

### 1.5 The Main Menu

The right hand Master Screen has a DiGiCo logo icon at the top which is used to open the **Main Menu**  
 The Main Menu contains a number of buttons which are used to access various console functions

#### 1.5.1 Session Management.....

Touching the **Sessions & Snapshots** button opens a display which contains file management functions in the top bar and Snapshot control in the main area of the screen.

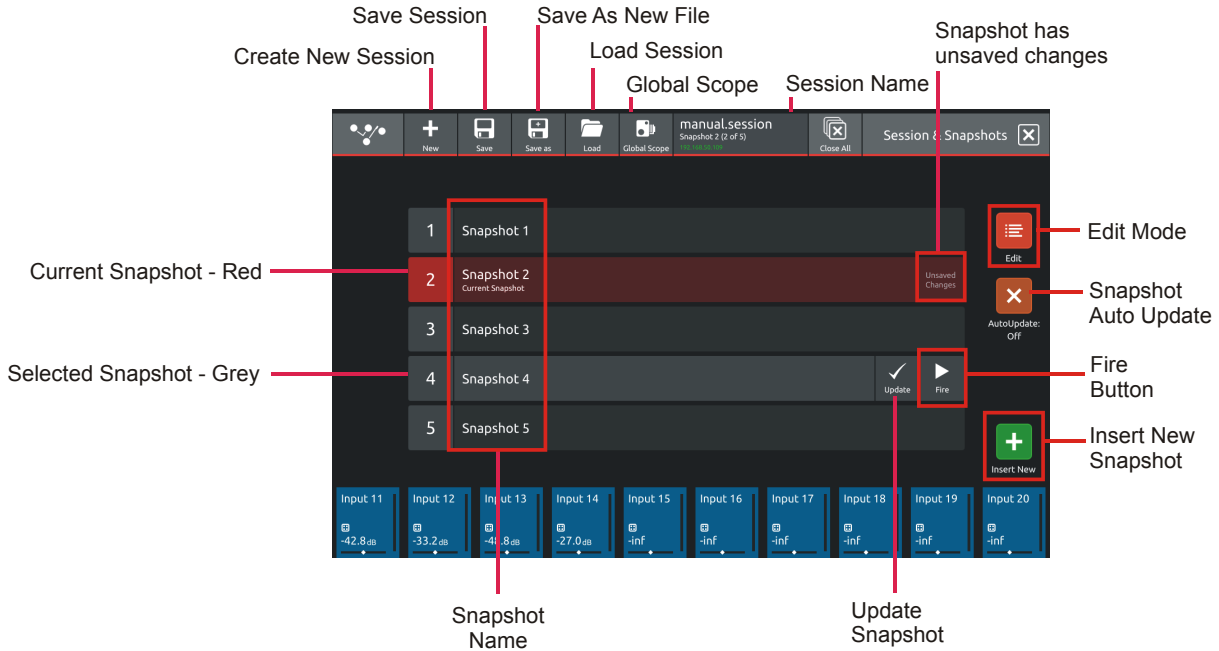

**NOTE: The Auto-Update button on the left of the screen relates to Snapshots and not to Sessions**  
**When active, this function will automatically update the current Snapshot as changes are made on the console.**  
**Please read the Snapshot section and only activate this function if you definitely require it.**

To create a new session, touch the **New** button in the top bar and a progress bar will be displayed.  
 When the process is complete, touch the **Save As** button, select the internal drive (labelled **Internal**) or the **USB** port (with a USB key inserted into the console USB port) and touch the **Save Here** button.  
 Then type a new session name using the on-screen keyboard and touch the **Done** button.  
 To update the session after the initial Save As process, just touch the **Save** button and the current session will be updated automatically.  
 To load an existing session, touch the **Load** button, select the internal or USB drive and then select the required session from the list and touch the **OK** button.

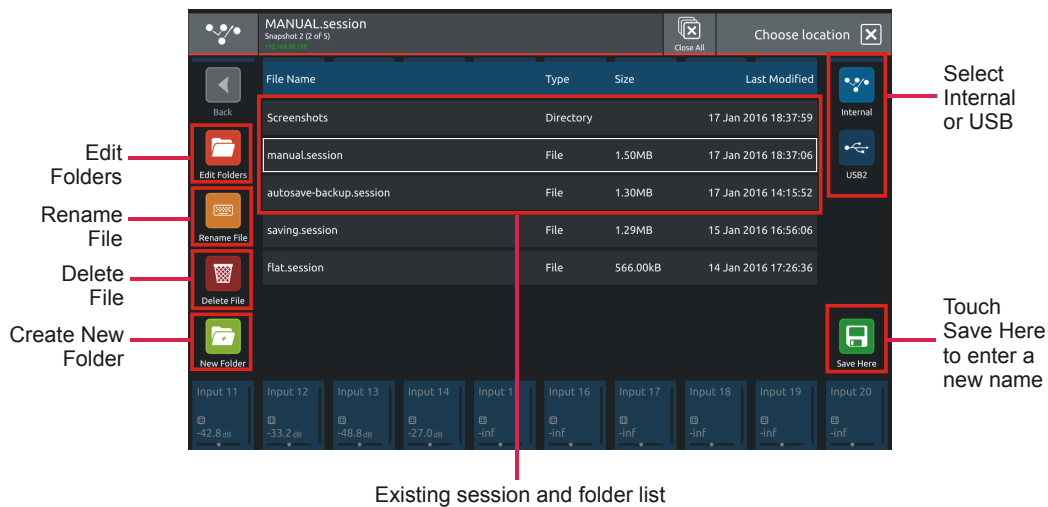

All other file and folder management functions are also available on this panel

### 1.5.2 Snapshots .....

The S21 always has at least one Snapshot in its list and more can be added using the **Insert New** button in the bottom right corner of the screen (there is also a Macro available for this function). The **Current** Snapshot is highlighted in **red**.

We recommend that the first snapshot is used as a "Setup" Snapshot where all of your "session wide" settings like routing, Control Group membership and Buss Modes (whether Busses are Groups or Auxes) are first stored. Because these types of setting can be changed with Snapshot recall, it is advisable to save them all into this first snapshot before creating any further Snapshots. In this way, the settings for all subsequent Snapshots will contain the same data and there should be less requirement to adjust the Safe settings in the channels.

When a Snapshot is created it will always save all of the current console settings and it will be placed in the Snapshot list after the **Selected** (highlighted in **light grey**) Snapshot.

Subsequently, certain console parameters can be isolated or made "**Safe**" from **Snapshot Recall** as required.

To recall (Fire) a different Snapshot, it must first be selected on the list, highlighting it in light grey, and then the **Fire** button should be touched.

The Previous and Next Snapshots in the list can also be fired by pressing the **Prev/Next** buttons on the worksurface.

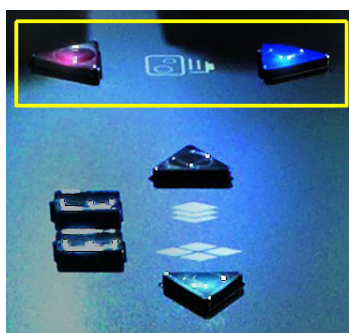

When the console state has changed but the current Snapshot has not been updated, the Snapshot will be marked as having "**Unused changes**". Pressing the update button on the current Snapshot will store these unused changes.

To change a Snapshot name touch the **Edit** button at the top of the list, touch the Snapshot name and type using the on-screen keyboard.

To delete a Snapshot, touch the **Edit** button (if not already active) and then touch the **Delete** button (dustbin icon) next to the required Snapshot. You will then be required to confirm the action by touching the **Yes** button.

To rename a Snapshot, touch the **Edit** button (if not already active) and then touch the **Rename** button next to the required Snapshot. You will then be required to enter a new name and confirm

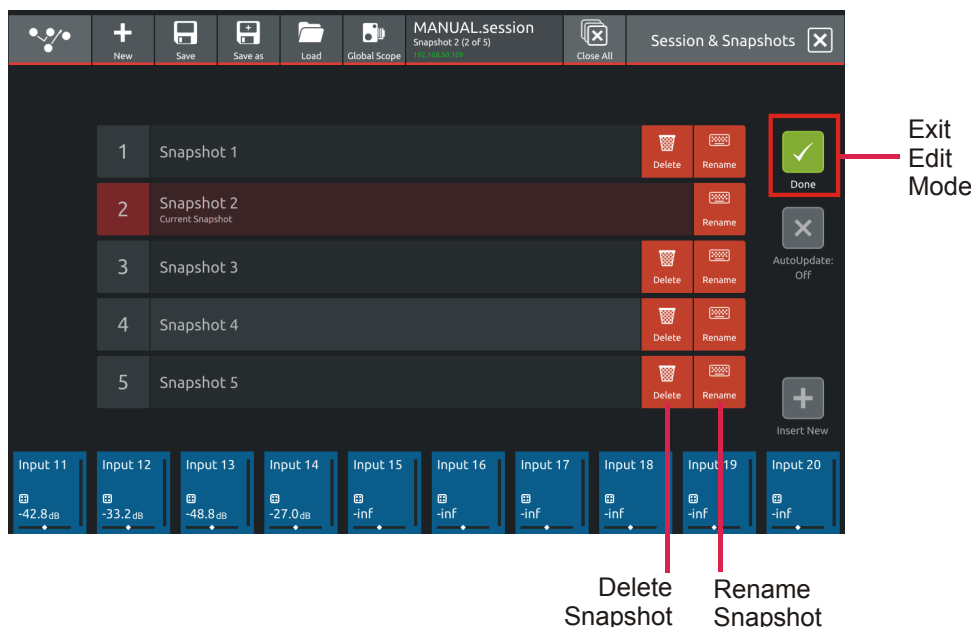

## Snapshot Global Recall Scope

Snapshot recall can be controlled globally with the Global Recall Scope settings.

These settings can allow or prevent selected console parameters from being affected by the Snapshot system.

It is recommended that if you are using Snapshots, you set the Global Scope before you start creating the Snapshot list.

However, the Global Scope can be changed at any time.

From the Main Menu > Sessions & Snapshots view touch the **Global Scope** button in the top bar.

The **Global Scope Setup** view will now be displayed - Each block represents a different set of console parameters

The default setting for Global Scope will display all of the blocks highlighted in green and this indicates that they are **"In Scope"** and can therefore all be recalled with Snapshots (subject to parameter Safe settings)

Touching an individual block will remove the green highlight and this block of parameters is now **"Out of Scope"** and can therefore not be affected by any Snapshot recall - its settings can only be changed manually.

For example, in the final picture below, the Global Scope has been adjusted so that only faders, mutes, pans, FX and GEQs can be changed with Snapshots

In the top bar on the Global Scope panel there is also a button that allows all parameters to be **enabled/disabled** at the same time which can make the selection process easier.

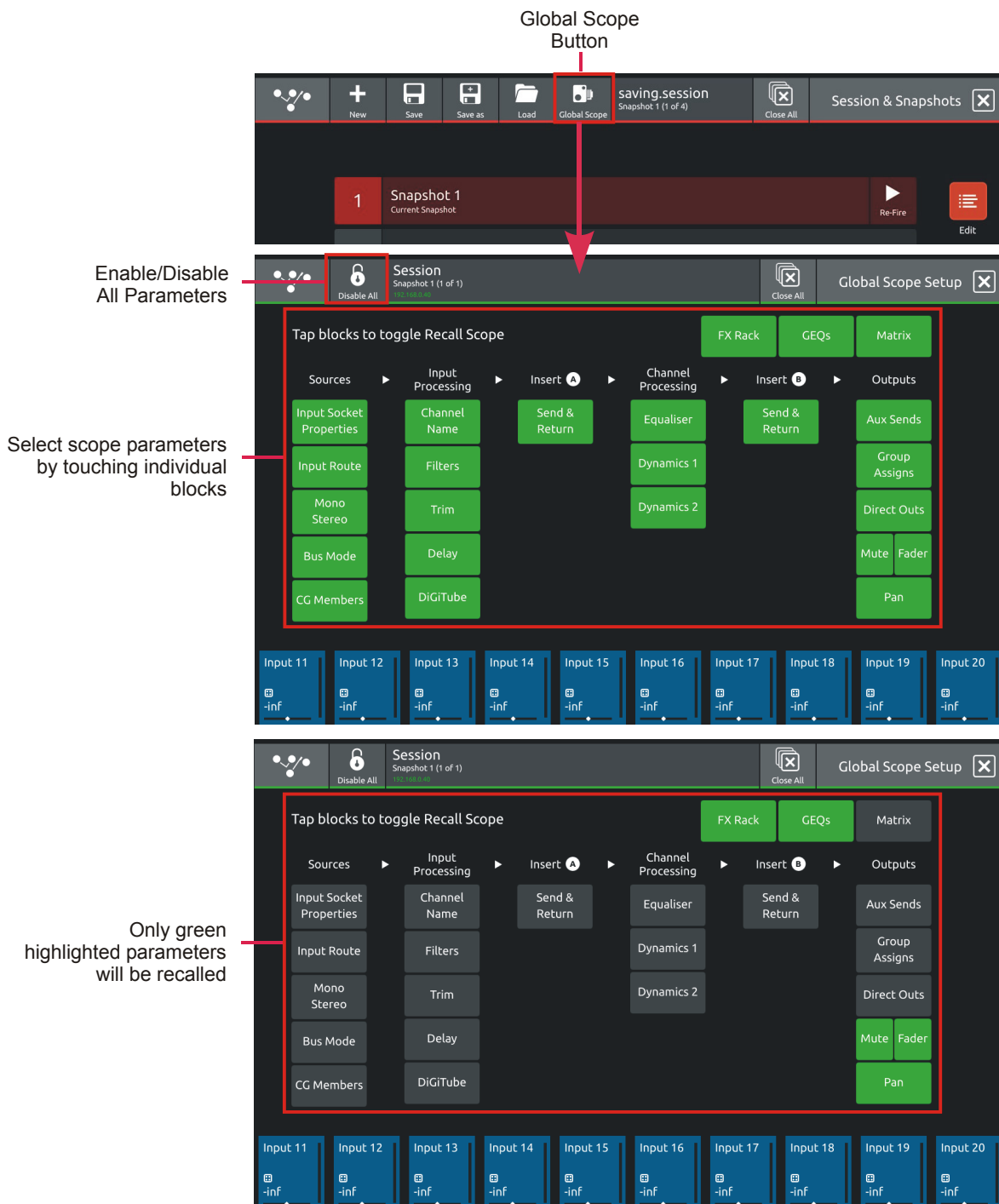

## Snapshot Recall Safes

To prevent parameters from being recalled by Snapshots, use the **Safe** functions on each channel which are accessed through the Channel Setup view Safes button in the top bar. If a parameter is Safe, it cannot be affected by any Snapshot Recall. Each block represents a section of the channel as labelled - touch the block, it will be highlighted in red and the Safe will be applied.

**NOTE: Socket Properties comprise Analogue Gain, +48V, Input Pad and AES SRC where appropriate. These properties can apply to more than one input channel which is using the same input socket and therefore the Safe state will automatically be the same on all channels that are sharing that socket. If there is no socket routed into the channel, the Safe function will not be available.**

**NOTE: Control Group membership and Buss Modes (Aux or Group) only apply to their relevant channel types and will therefore not be available in input channels**

There is also an **Full Safe On/Off** button in the top bar to Safe all of the channel parameters at the same time.

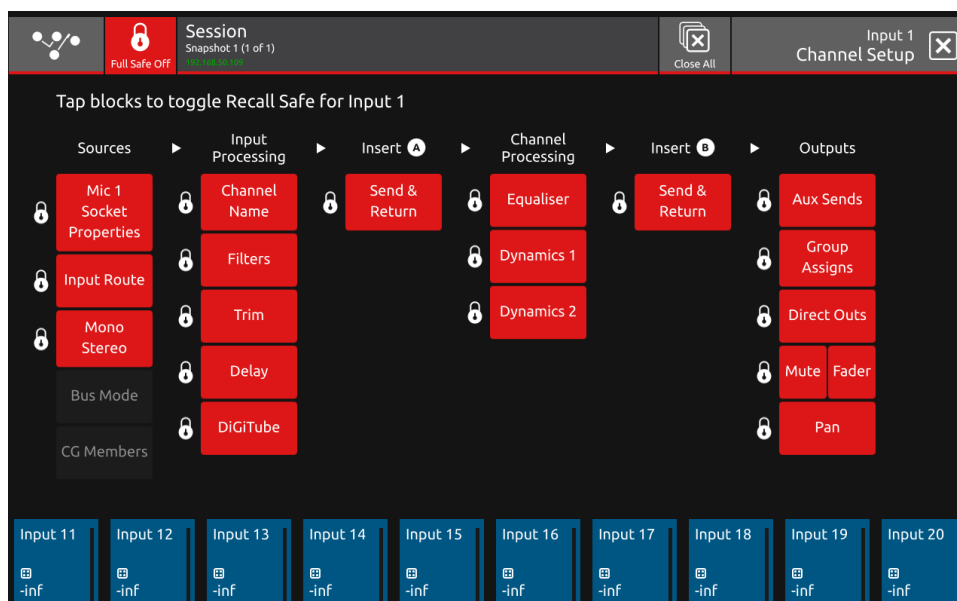

Safes are also available for **individual FX units, Graphic EQ (globally) and individual Matrix Inputs**. The buttons to activate the functions are all located in the top bar of the relevant view.



## 1.5.3 Preferences .....

Touching the Main Menu > **Preferences** button displays and allows the setting of certain console options.

The **Aux Sends on Faders** option (also available as a Macro function), when active, assigns the complete row of Aux Sends to the channel faders when an Aux Send row is touched in the Channel view.

In this mode the channel's output block is highlighted with a purple background and the underscreen rotaries are assigned to Aux pans if a stereo Aux row is selected.

In this mode, touching and holding the Aux row will assign the Aux Sends to the underscreen rotaries - the output blocks will turn blue but the selected Aux row will remain purple.

To reassign the channel faders to their standard function, touch the channel's output block at the bottom of the Channel view, the output blocks will revert to the standard blue colour and the faders will control the channel level again.

**Solo selects channel** - Pressing a channel solo button selects that channel on screen

**Disable Snapshot buttons** - the worksurface snapshot Previous and Next buttons are disabled

**Global Tempo** - the 6th Master Rotary to the right of the screen controls the Global Tap Tempo value when touched repeatedly

**Brightness Controls** - Screen backlight, worksurface LEDs and the Light Bar brightness can be independently adjusted

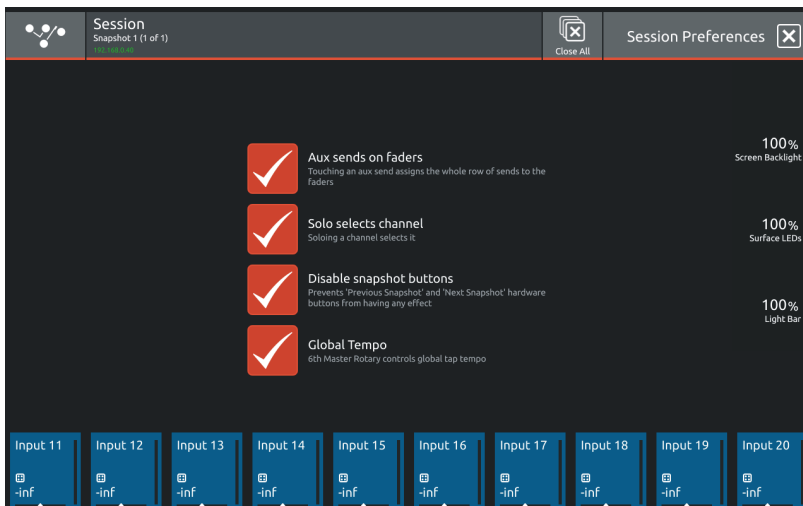

**NOTE: Macro buttons are also available for the Aux Sends on Faders and Global Tap Tempo Preferences**

## 1.5.4 Audio Sync .....

Touching the Main Menu > **Audio Sync** button displays and allows the setting of console Audio Sync options.

The console's sample rate can be changed from its default **96KHz** to **48KHz** but this has a confirmation stage as the audio will be affected during the switch.

**Note: In V1.1 software, when a New Session is created, the console will always default to a 96KHz sample rate**

In normal operation the console should be set to **Internal Sync** and it will automatically provide sync to connected DiGiCo I/O racks via the DMI interface cards.

Other sync options available are the **Word Clock** input on the console back panel and the **Local I/O AES/EBU** input.

Also **DMI Card 1** or **DMI Card 2** can be used as sync sources.

These options should only be selected if the console is not intended to be the Sync Master for the system.

When a valid sync source is available, the relevant item on-screen will display an indicator to confirm this.

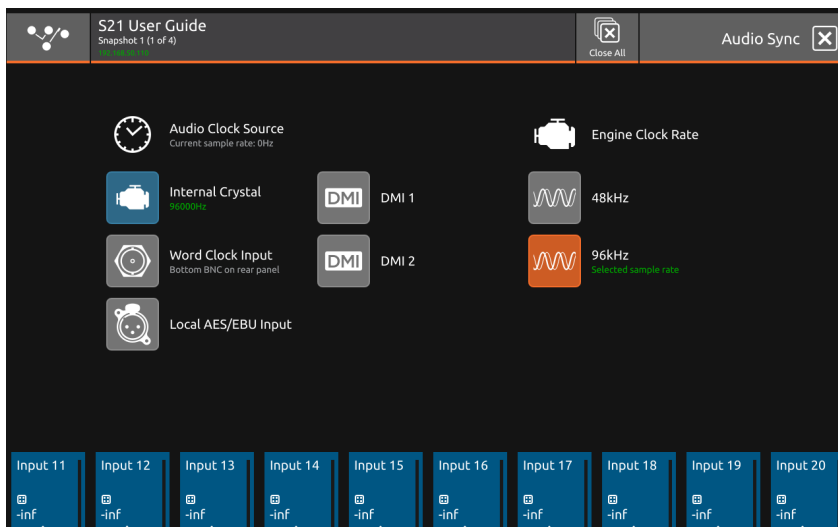

## 1.5.5 Macros .....

Touching the Main Menu > **Macros** button displays a list of factory provided Macros that can be assigned to the Macro bar at the top of the left hand screen.

The Macro bar is visible in all console views.

To assign a Macro to the bar, touch and hold on the required Macro on the left screen and drag it into the Macro bar at the top.

To remove a Macro from the bar, touch and hold on the required Macro and drag it back into the main screen area.

Macros can also be reordered within the Macro bar by touching, holding and drag/drop.

The Macro bar can display up to 10 Macros at one time and if more Macros are added, up to 4 groups of 10 Macros can be displayed by swiping horizontally in the Macro bar itself.

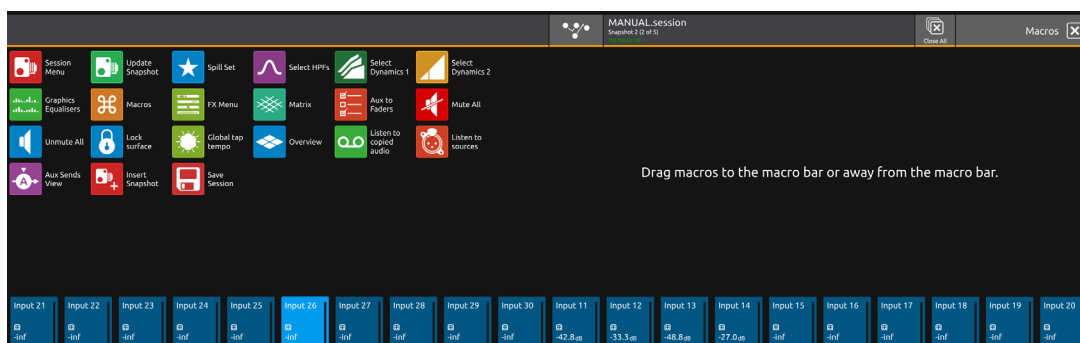

## 1.5.6 FX Rack .....

**Note: A maximum of 6 Studio Delay units can be used in combination with any type of Reverb**

Touching the Main Menu > **FX Rack** button displays the FX slots and the FX units that are assigned to them.

If a slot is empty, touch that slot and select the required FX unit from the scrollable FX picker list, this will then be added to the slot and opened to display its expanded view.

FX parameters can be adjusted on-screen by touching/dragging the controls or by using the Master rotaries to the right of the screen.

Close this view to return to the FX overview and touch on any existing effect to reopen the expanded view.

To change the FX unit type in a slot, touch and hold on the existing unit in the slot and FX picker will be displayed

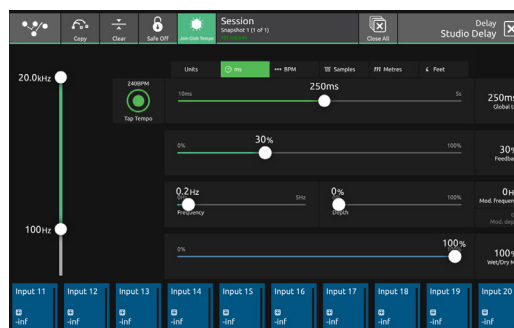

### To route signal to an FX unit:

Open the Channel Setup view for the required Input Channel or Aux Master by touching the top of the channel strip

Touch the Direct Outputs block on the right of the screen which opens the output routing view

Select **Effects** from the **Internal Port Group** in the top left of the screen

Select a socket(s) for the required FX inputs

### To route signal from an FX unit:

Open the Channel Setup view for the required Input Channel which will be the FX return by touching the top of the channel strip

Touch the input block in the **Source** column which opens the input routing view

Select **Effects** from the **Internal Port Group** in the top left of the screen

Select a socket(s) for the required FX returns

A similar routing procedure to the above should be used when inserting FX in a Channel Insert point.

The Channel Insert routing (A or B) is also found in the Channel Setup View.

The buttons in the top bar of the expanded FX view also provide the following functions:

**Copy** FX from one FX slot to another - touch the copy button and then touch the required destination slot and the confirm copy button

**Clear** FX - Set the parameters of the FX unit to its default settings - touch the Clear button

**Safe** FX - touch the Safe button, it will highlight in red and so will the outline of the FX unit in the FX overview

## Delay Tap Tempo

In the **Main Menu > FX Rack**, each on screen Delay unit has its own **individual tap tempo button**  
 This button is also in the Delay unit expanded view

The worksurface **6th Master Rotary control** can be used as a **Global Tap Tempo** input device and a tempo entered in this way can be applied to single or multiple Delay units in the FX rack  
 The 6th Master Rotary should be tapped rather than switched (pushed) as it is a touch sensitive control.  
 The green LED ring on this control will flash at the tap speed.

To activate the Global Tap Tempo controller, touch either the **Global Tap Tempo On/Off switch** in the top bar of the FX Rack view or use the **Global Tap Tempo On/Off Macro**  
 There is also a Global Tap Tempo On/Off switch in the **Preferences Menu** for this function

To enable a Delay unit to be affected by the Global Tap Tempo, touch the **Join Global Tempo** button in the Delay unit's expanded view.  
 When a new Delay unit is inserted in the FX rack, Join Global Tempo is switched on by default but it can be switched off.  
 In this way, single or multiple Delay units can be affected by the same Global Tap Tempo value.

Global Tap Tempo On/Off Macro      Linked      Global Tap Tempo On/Off switch      Individual Tap Tempo

Join Global Tap Tempo

Individual Tap Tempo

20.0kHz

240BPM Tap Tempo

250ms Global tap

30% Feedback

0.2Hz Frequency

0% Depth

100% Wet/Dry Mix

6th Master Rotary Global Tap Tempo

### 1.5.7 Graphic EQs.....

Touching the Main Menu > **Graphic EQs** button will display and allow the setting of the Graphic EQs

When this view is opened, the console's channel faders are immediately assigned to the selected Graphic EQ. Use these faders to change the levels.

To select a different Graphic EQ, touch in the small blocks at the top of the screen and this will reassign the channel faders to that EQ.

The display highlights the 20 bands that are currently assigned to the faders and to change the assignment, just drag horizontally in the area between the bottom of the on-screen faders and the frequency labels at the bottom of the screen.

The selected Graphic EQ unit has a **Trim** control and an **On/Off** switch assigned to the 2nd and 3rd Master rotaries on the right of the screens.

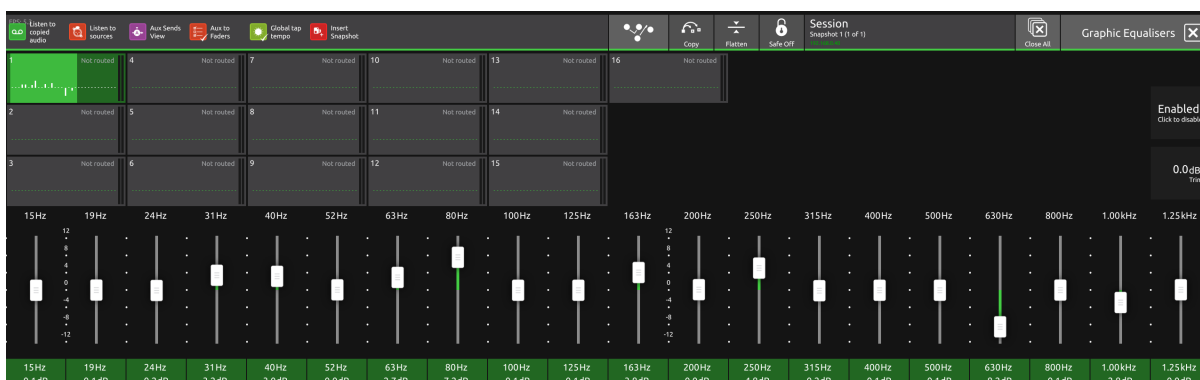

#### To route signal to/from a Graphic EQ using a channel insert point:

Open the Channel Setup view for the required Input Channel or Output channel by touching the top of the channel strip

Touch the Insert Send block on the Insert A or B column which opens the output routing view

Select **Graphic EQs** from the **Internal Port Group** in the top left of the screen

Select a socket(s) for the required Graphic EQ inputs

Close the output routing view

Touch the Insert Return block on the Insert A or B column which opens the input routing view

Select **Graphic EQs** from the **Internal Port Group** in the top left of the screen

Select a socket(s) for the required Graphic EQ outputs

Touch the Insert On/Off button to activate the insert point

This routing will now also be displayed in the relevant Graphic EQ block in the Graphic EQ view

#### Copy Graphic EQ

Graphic EQ settings can be copied from one Graphic EQ to single or multiple others using the Copy button in the Graphic EQ view

Open the **Graphic EQ view** by touching the Graphic EQ button in the Main Menu

Select a **Source Graphic EQ** unit by touching it on screen

Touch the **Copy** button in the top bar

Select the **Destination Graphic EQ units(s)** by touching them on screen - they will have a white outline

Touch the **OK** button in the bottom right of the screen

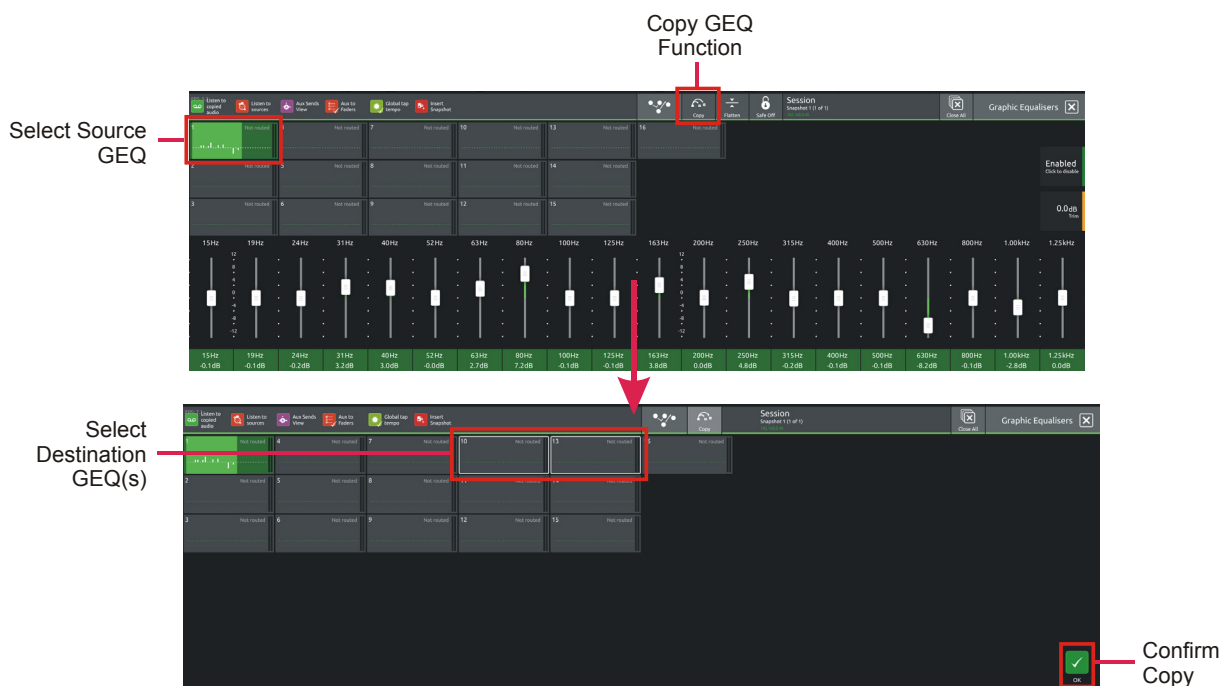

### 1.5.8 Send & Return Insert Routing .....

For insert points routed to/from internal sources like Graphic EQ and Effects plus Record Sends & Returns to/from UBMADI, there is an option to route the send and return sockets together automatically.

Open the Insert Send routing view

Select the relevant port for the Insert Send destination eg Graphic EQ

Touch the Send & Return Routing button in the top bar to highlight it

Select the required Insert Send socket eg Graphic EQ 8

The Insert Return for this Insert point will now be routed automatically from Graphic EQ 8

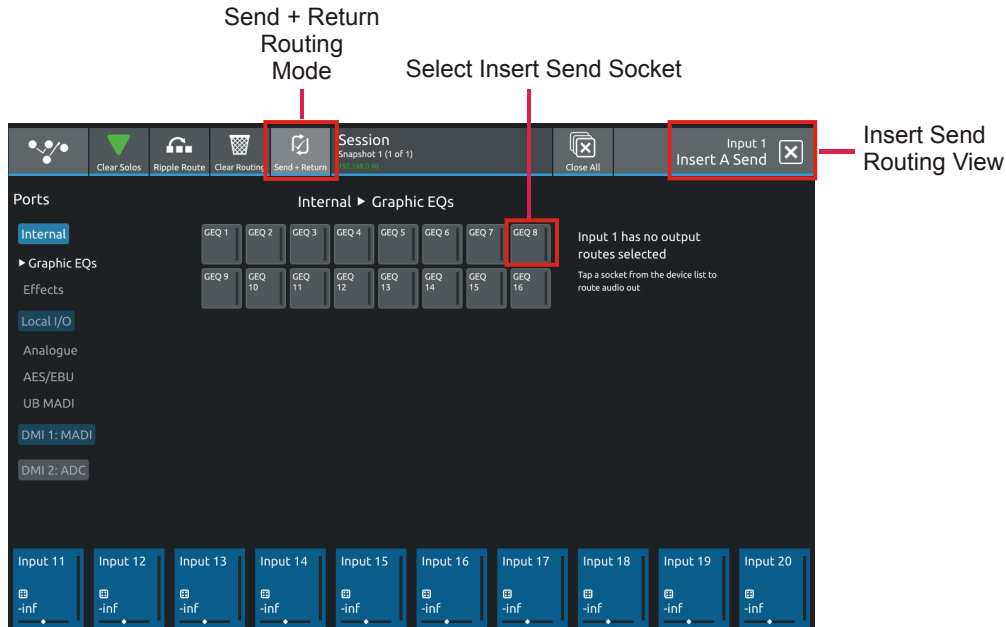

### 1.5.9 Matrix .....

Touching the Main Menu > **Matrix** button will display and allow the setting of the Matrix Inputs and Matrix Sends

The Matrix has 10 inputs and 8 outputs displayed in a grid on screen.

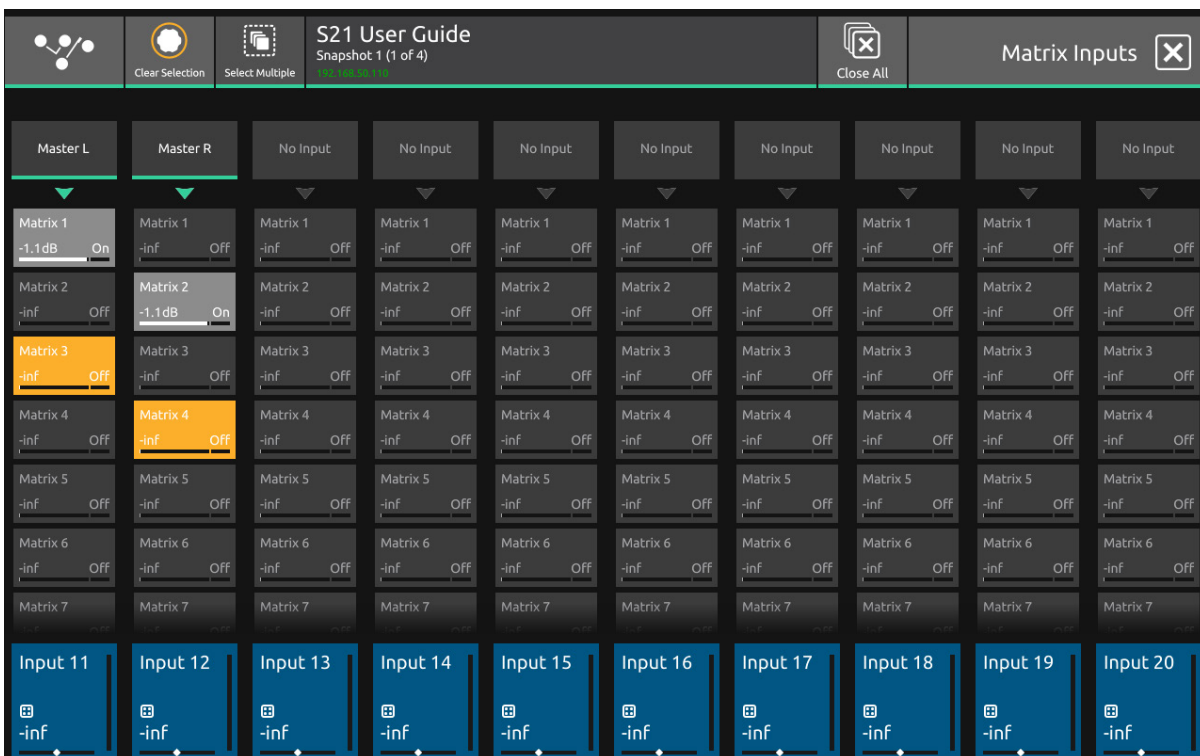

Matrix Inputs are selected by touching in the block at the top of the Matrix Input channel which is labelled **No Input** when it is not assigned. This opens the **Matrix Input Routing View**

Select the relevant internal port, rack or local I/O from the ports column and the select the required input socket from the socket display.

Close the view to return to the Matrix Inputs grid view.

To switch Matrix Nodes On/Off and control the send levels:

Select the required nodes by touching them on-screen - each selected node will be highlighted in orange.

If the **Select Multiple** button is active in the top bar then multiple nodes can be selected and adjusted at the same time.

Touching the Select Multiple button will activate **Select Single** mode which only allows one node to be selected at a time.

Once nodes are selected, they can be adjusted using the Touch/Turn control assigned to the 6th Master Rotary on the worksurface. This is also lit in orange.

Push the rotary control to switch nodes On/Off and turn to adjust the Matrix Send levels.

When the adjustments are done, either touch the selected nodes individually to deselect them or touch the **Clear Selection** button in the top bar.

### 1.5.10 System.....

Touching the Main Menu > **System** button will display and allow the setting of various system level console functions.

**NOTE: In normal operation there will seldom be any need to adjust any of these settings**

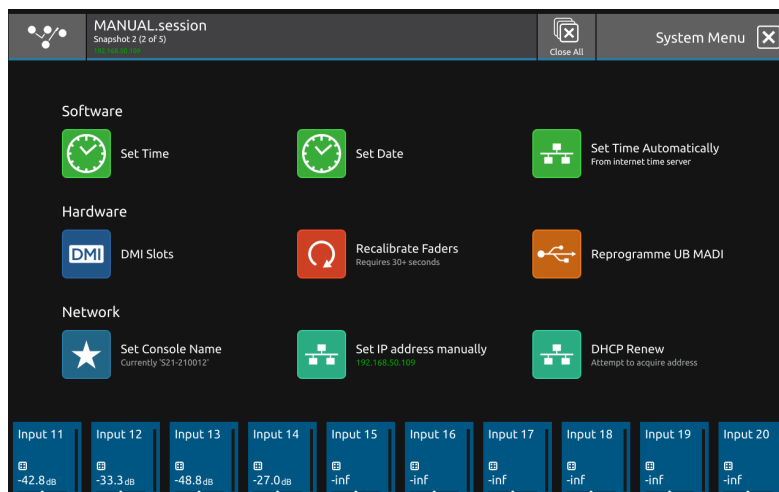

There are options to manually **set the time and date** for the console.

This can also be done automatically but requires an internet connection with a DHCP server.

**Faders can be calibrated** which is a process that takes approx 30 seconds - **please do not do this unless advised to do so by DiGiCo Support**

The **UBMADI interface** can be reprogrammed with new firmware if required - **please do not do this unless advised to do so by DiGiCo Support**

The **console name** can be reset and the console's **IP address** set or renewed via DHCP - **please do not do this unless advised to do so by DiGiCo Support**

**DMI Cards** can have their software or firmware upgraded or downgraded to a version which is approved for S21

This will be required if the DMI firmware dates do not match the required code dates for S21 which are embedded in the application.

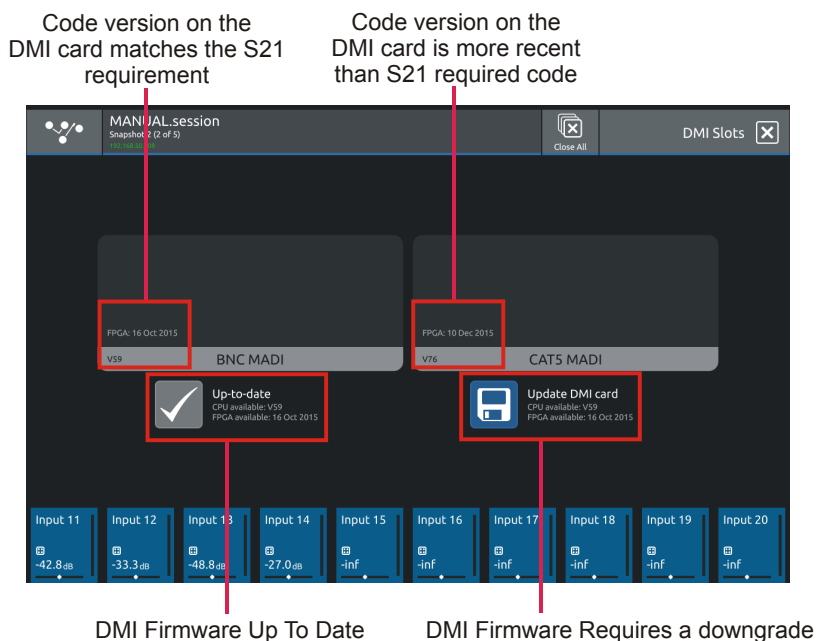

Code version on the DMI card matches the S21 requirement

Code version on the DMI card is more recent than S21 required code

DMI Firmware Up To Date

DMI Firmware Requires a downgrade

## 1.5.11 Diagnostics .....

Touching the Main Menu > **Diagnostics** button will display various console settings such as software and firmware versions. This information may be required in the event of troubleshooting procedures

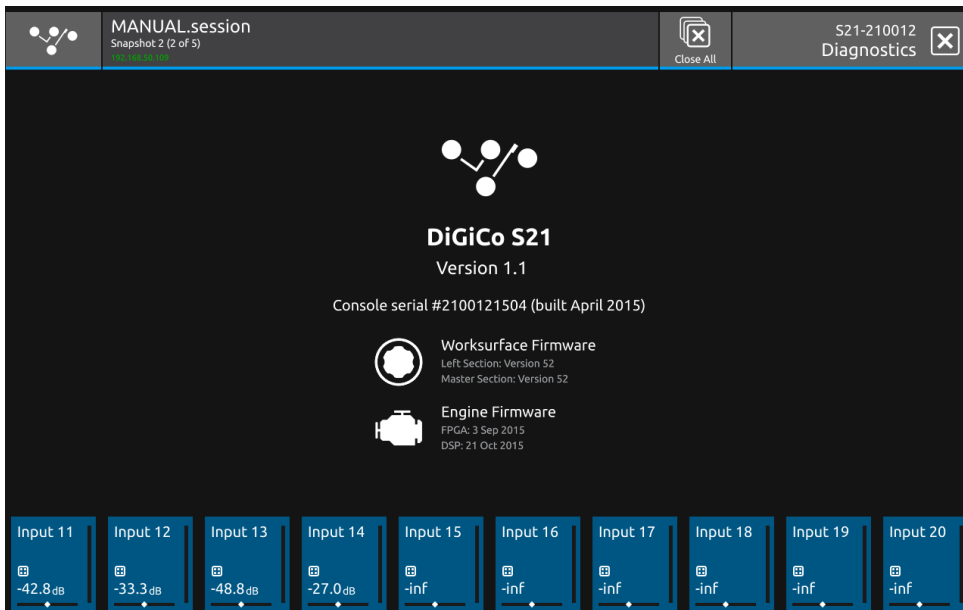

## 1.5.12 Restart or Shutdown .....

Touching the Main Menu > **Restart or Shutdown** button displays a number of options for restarting, closing down and temporarily locking the console.

To Shut Down the console, first touch the **Shut Down** button and then when a power icon appears on screen, power off using the switch on the rear panel.

The console surface can be locked by touching the **Lock Surface** button and a padlock will be displayed on the screen with an instruction on how to unlock it again.

This function is simply intended to avoid accidental changes being made to worksurface and screen controls.

In the event of an issue with the console that requires a reset there are 3 options for restarting without a power cycle.

**Restart App and Engine** - this will interrupt the audio briefly

**Restart O/S** - this will interrupt the audio

**Warm boot** - there is a small red reset button recessed on the console rear panel which will reset the console computer and will also cause a brief interruption in audio

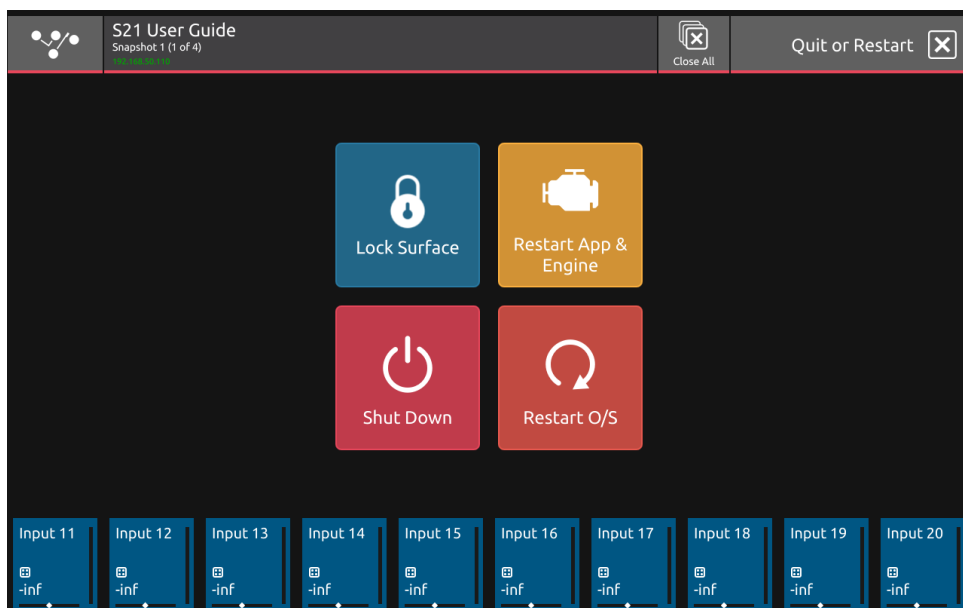

### 1.5.13 Upgrading Software .....

S21 Software can be upgraded by downloading a file as advised by support@digiconsoles.com, copying this to a USB key and proceeding as follows:

1. Copy the downloaded file to the root folder of a USB key – ensure that it is called update.dcu
2. Switch the console off
3. Insert the USB key in the console USB port
4. Hold down the “Overview” button on the console worksurface

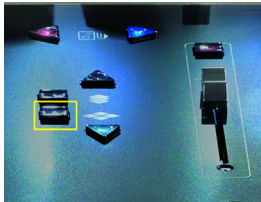

5. Switch the console on and keep the overview button held for about 5 seconds and then release it
6. You should then see a series of icons on the screen starting with a clock icon
7. Wait for the console application to boot
8. Open the main menu and check the version number at the bottom of the screen
9. Upgrade complete



## 2.1 DMI Cards

The Digico S21 has two option slots on its rear panel for the installation of DMI cards (see below)  
 These cards come in a variety of I/O types.

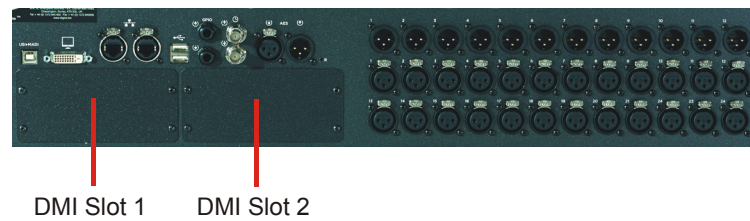

### 2.1.2 Fitting DMI Cards.....

**Note: DMI cards are NOT hot swappable and therefore they should NEVER be fitted or removed from the S21 while the console is powered on.**

To fit a DMI card:

1) Remove the four screws from the console blanking plate and this will expose a hole in the rear panel with an internal connector and a white slider on each side of the hole. Keep the four screws safe in order to secure the card in place.

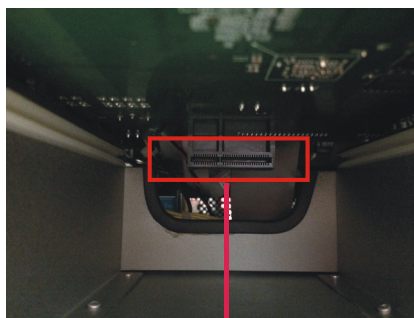

DMI Internal Socket

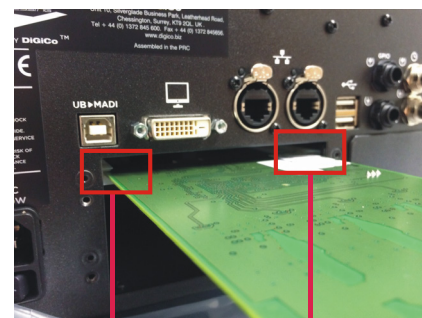

Card fits in slider grooves

**Note: Before fitting the DMI card, carefully examine the internal connector as in some cases this may have a protective cover that must be removed before fitting the card. If the cover is present, please remove it before proceeding**

**Note: With MADi DMI C there are 2 internal switches that must be set to the A position for use in the S21. Please check these switch positions (as picture below) before fitting the card.**

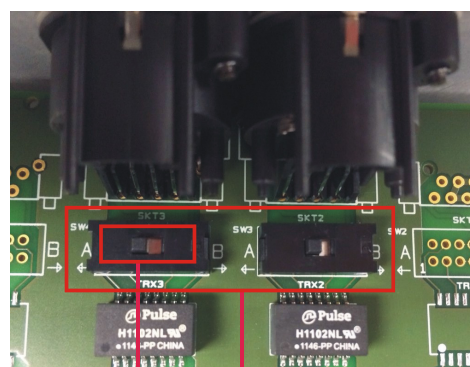

Position A for console use

MADi DMI C internal switches

2) Carefully slide the DMI card in the hole using the white slider grooves as a guide and then ensure that it pushes into the internal connector correctly with a click.

3) Replace the 4 fitting screws.

## 2.2 MADi DMI Cards

There are 2 types of MADi DMI Card:

- MADi B has 2 pairs of BNC connectors**
- MADi C has 2 bi-directional Cat5e connectors**

Both of these cards can be used to connect a Standard MADi stream at 48KHz or 96KHz or an SD-Series DiGiCo Rack with the appropriate connector (D-Rack, D2-Rack, SD-Rack, SD-MINIRack)

*Note: Only one DiGiCo Rack can be connected to a single MADi DMI card at one time*

*Note: With S21 software version 1.0.1, cable redundancy at 48KHz using both the Main and Aux MADi ports on a D2-Rack, SD-Rack or SD-MINIRack is not implemented*

### 2.2.1 Connecting MADi DMI .....

External audio connections can be made using either BNC MADi (AES10) or the DiGiCo Cat5e Connection.

There are 2 types of MADi connection available. A DiGiCo Stage rack can be connected to a console via a bi-directional MADi connection will have upto 112 channels (56 in, 56 out) of audio plus the control data for the Rack (located on CH57). A bi-directional standard MADi stream will contain upto 128 channels of Audio (64 in, 64 out) and can be connected to any 3rd party device that has MADi connection.

A DiGiCo Cat5e connection is a bi-directional up to 64 Channel interface that uses STP Cat5e Cable with interference suppressors fitted on each end used to connect D-Racks and D2-Racks.

**Please carefully note the following connection requirements:**

#### DMI MADi C to D-Rack at 48KHz

Connect DMI card Cat5e socket A to D-Rack Cat5e socket

#### DMI MADi C to D-Rack at 96KHz

Connect DMI card Cat5e socket A to D-Rack Cat5e socket

**Note: This setup provides one 28 channel 96KHz MADi stream therefore D-Rack input sockets 29-32 will not pass audio**

### Single S21 to D-Rack with DMI MADi C Card

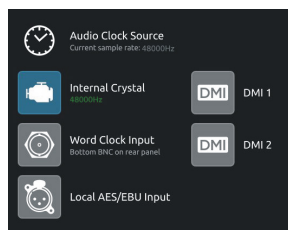
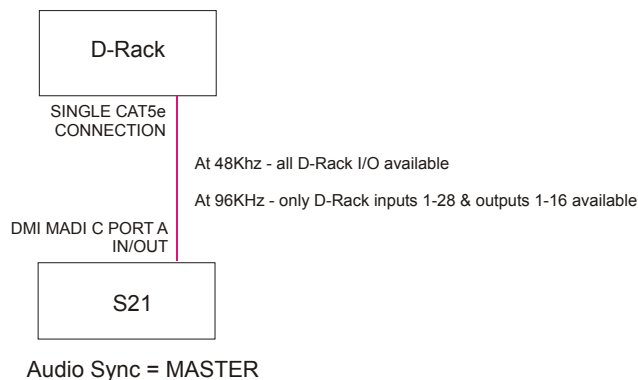

**DMI MADI C to D2-Rack at 48KHz**

Connect DMI card Cat5e socket A to D2-Rack Cat5e Main socket

**Single S21 to D2-Rack with DMI MADI C Card at 48KHz**

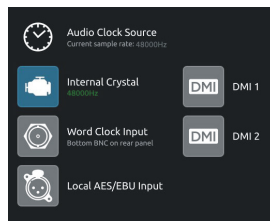
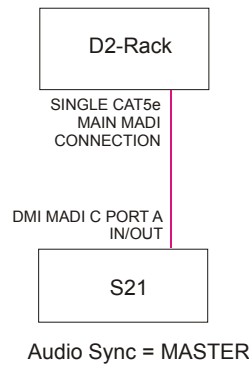

**DMI MADI C to D2-Rack at 96KHz**

Connect DMI card Cat5e socket A to D2-Rack Cat5e MAIN socket

Connect DMI card Cat5e socket B to D2-Rack Cat5e AUX socket

**Single S21 to D2-Rack with DMI MADI C Card at 96KHz**

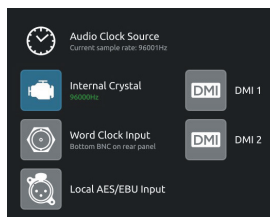
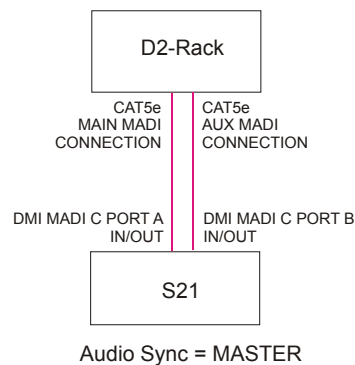

## DMI MADI B to D2-Rack, SD-Rack or SD-MINIRack at 48KHz

Connect DMI card BNC IN socket A to D2-Rack BNC OUT MAIN socket  
 Connect DMI card BNC OUT socket A to D2-Rack BNC IN MAIN socket

### Single S21 to D2-Rack with DMI MADI B Card at 48KHz

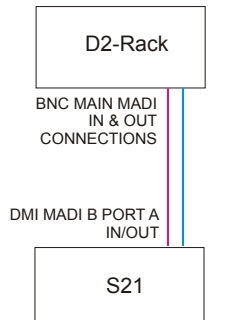

Audio Sync = MASTER

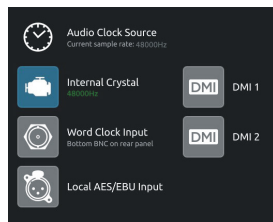

## DMI MADI B to D2-Rack, SD-Rack or SD-MINIRack at 96KHz

Connect DMI card BNC IN socket A to D2-Rack BNC OUT MAIN socket  
 Connect DMI card BNC OUT socket A to D2-Rack BNC IN MAIN socket  
 Connect DMI card BNC IN socket B to D2-Rack BNC OUT AUX socket  
 Connect DMI card BNC OUT socket B to D2-Rack BNC IN AUX socket

### Single S21 to D2-Rack with DMI MADI B Card at 96KHz

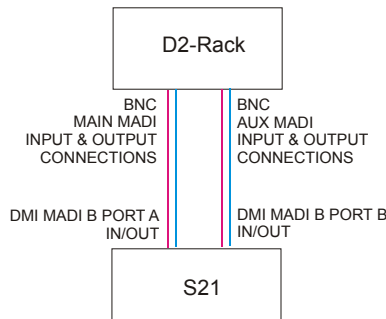

Audio Sync = MASTER

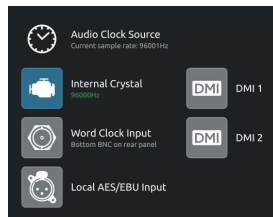

## DMI MADI B to a Standard MADI device at 48KHz

Connect DMI card BNC IN socket A to Standard MADI device BNC OUT  
 Connect DMI card BNC OUT socket A to Standard MADI device BNC IN

## DMI MADI B to a Standard MADI device at 96KHz

Connect DMI card BNC IN socket A to Standard MADI device CH 1-32 BNC OUT  
 Connect DMI card BNC OUT socket A to Standard MADI device CH 1-32 BNC IN  
 Connect DMI card BNC IN socket B to Standard MADI device CH 33-64 BNC OUT  
 Connect DMI card BNC OUT socket B to Standard MADI device CH 33-64 BNC IN

### 2.2.2 Sharing Racks with MADI.....

If the system is running at a sample rate of 48KHz a D2-Rack, SD-Rack or SD-MINIRack can be shared between 2 consoles (Two S21s or an S21 and another SD-Series console) with the connection system shown below.

**In this setup:**

- 1) All inputs can be shared by the two consoles but only one console controls the rack analogue gains (the "Master" console)
- 2) The console which is not controlling the gains (the "Slave" console) can automatically adjust its digital trims to compensate for the gain changes using a system known as "Gain Tracking" (see below)
- 3) Only the "Master" console can use the outputs of the shared rack

The recommended connection between the Monitor (Slave) console and Stage Rack is a single MADI OUT from the Shared Rack's AUX MADI connected to the console's MADI A IN

The FOH (Master console) is connected via MADI A IN and OUT to the stage rack.

A similar method can be used if the Monitor console requires gain control and the FOH console will track the gain changes.

MADI OUT from the Shared Rack's AUX MADI connected to the FOH console's MADI A IN.

The Monitor (Master console) is connected via MADI A IN and OUT to the stage rack.

**Note: The "Master" console should be set to provide "Master Sync" (Main Menu/Audio Sync view - see diagram below) to the Shared rack**

**The "Slave" console should be set to receive its Audio Sync from the MADI DMI slot that is connected to the Shared Rack.**

- 1) The operators should agree on and set a level of analogue gain that provides enough headroom for the required application.
- 2) The second console should connect to the Shared rack in **Receive Only** mode (only MADI Input cable connected)
- 3) **Gain Tracking** (the **GT ON/OFF** button at the top of the Input channel setup view) can be switched on for the console that is in "Receive Only" mode for all the channels that are being shared.
- 4) When an analogue gain control is changed on the "Master" console, the "Slave" console's analogue gain should reflect the changes and the digital trim control should compensate for this change by moving by the same amount in the opposite direction.

**Note: The "Slave" console's Analogue gains should not be adjusted in this setup as they will have no effect on the rack and if Gain Tracking is active on a channel, the digital trim control will still respond to the local gain adjustment by compensating locally for the displayed gain change.**

#### FOH & MONITORS WITH SHARED RACK at 48KHz USING MADI

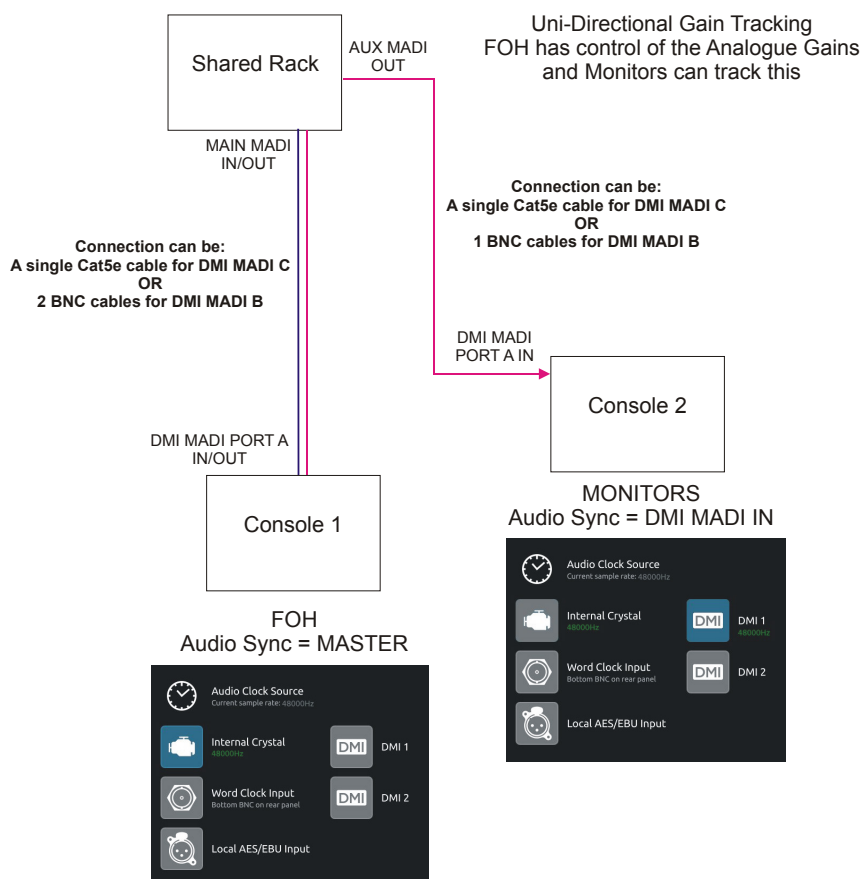

# DiGiCo S21

If the system is running at a sample rate of 48KHz, a D-Rack can also be shared between 2 consoles (Two S21s or an S21 and another SD-Series console with Cat5e connections eg SD9 or SD11) with the connection system shown below.

This setup is similar to the one previously described but requires a DiGiCo Little Red Box.

The Little Red Box has separate Cat5e connections for:

The D-Rack itself

The FULL CONNECT " Master" console

The RECEIVE ONLY "Slave" console

In all other respects the setup is the same as that for the D2-Rack and SD-Rack

## SHARING A D-RACK at 48KHz USING MADI

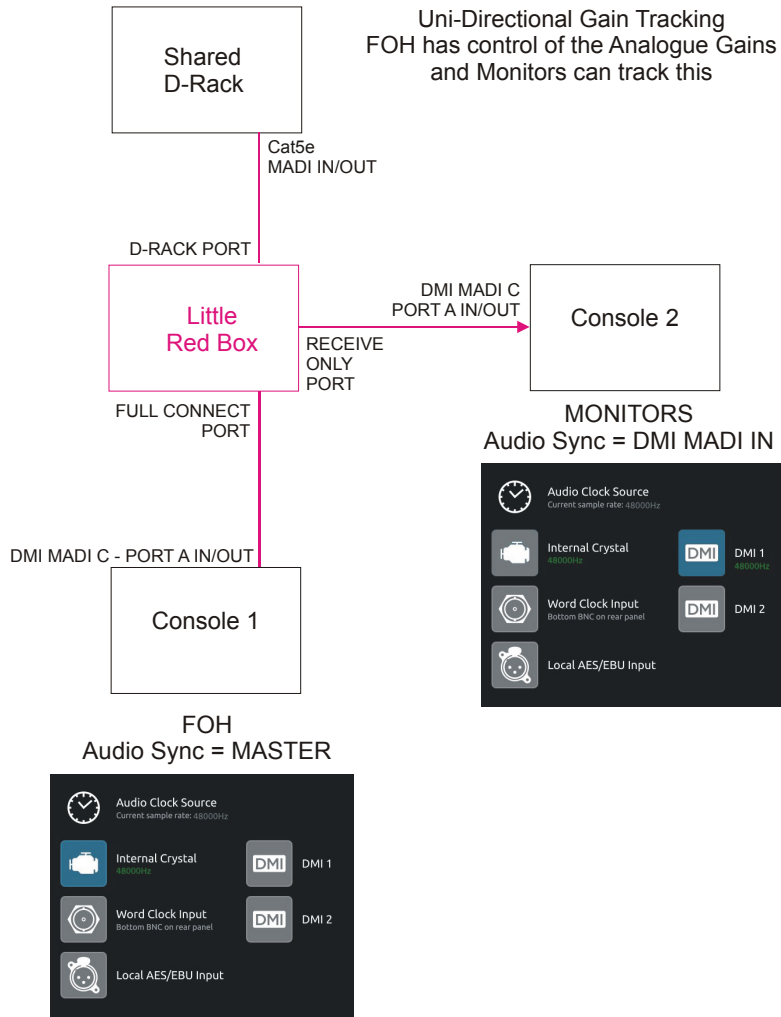

### 2.2.3 Auto-Discovery of DMI Cards & Racks.....

The S21 has a system of Auto-Discovery for DMI cards and racks connected to those cards.

It is therefore essential that DMI cards and racks are all correctly connected before the system is powered on.

**Note: DMI cards are NOT hot swappable and therefore they should NEVER be fitted or removed from the S21 while the console is powered on.**

The correct procedure is as follows:

- 1) Power off the console
- 2) Install DMI cards as required in the console
- 3) Make all necessary connections between DMI cards and required DiGiCo Racks and other Standard MADI devices
- 4) Power on all racks and connected Standard MADI devices before powering on the console
- 5) Power on the console

When the above procedure has been completed, open the S21 Input Routing view by touching the top of an input channel strip to display the Channel Setup view and then touch the Input Select button on the right hand side of the screen.

At the bottom of the port list, the DMI cards will be displayed as DMI 1 and DMI 2 and any connected racks will also be displayed. Touch the relevant DMI card button to display and select from the available inputs.

DMI card outputs will also be displayed in any of the output routing views (Direct Outputs / Insert Sends etc)

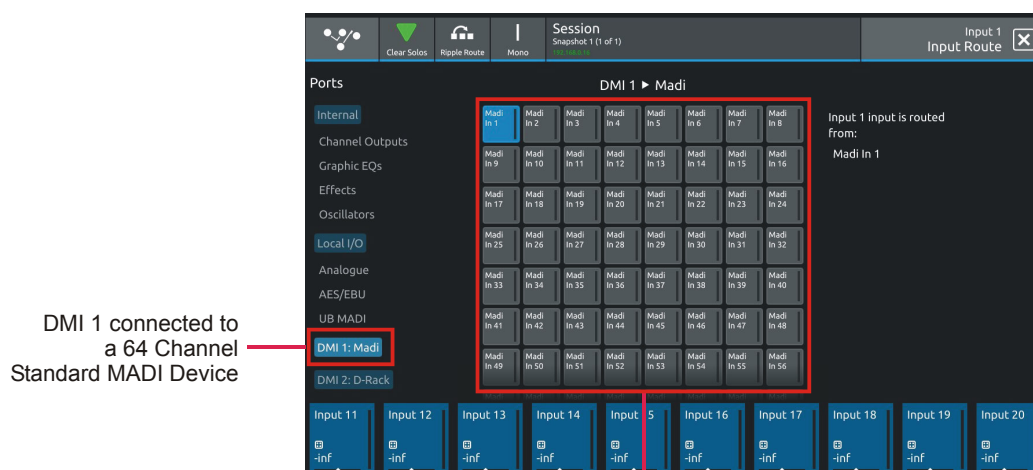

64 Standard MADI Inputs

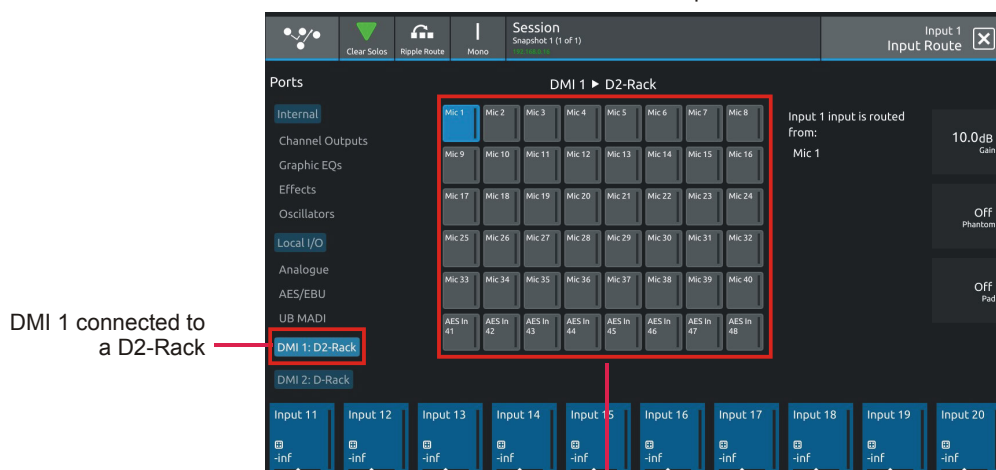

40 analogue inputs & 8 AES inputs

**IMPORTANT NOTE: If a MADI DMI card is connected to a rack or other Standard MADI device and the connection is changed to a different type of rack or device, the new connection will be discovered automatically after a few seconds and any routing that existed to the previously connected device will be removed.**

**Therefore please save your session before changing from one device type to another to ensure that the original setup can be reinstated later if required**

### 2.2.4 DMI Card Details & Upgrade.....

In the Main Menu > System > Hardware section there is a button which displays information about the installed DMI Cards including the current firmware dates.

This view is also used to upgrade the DMI firmware on the cards but please do not attempt to upgrade your cards unless instructed to do so by DiGiCo Support.

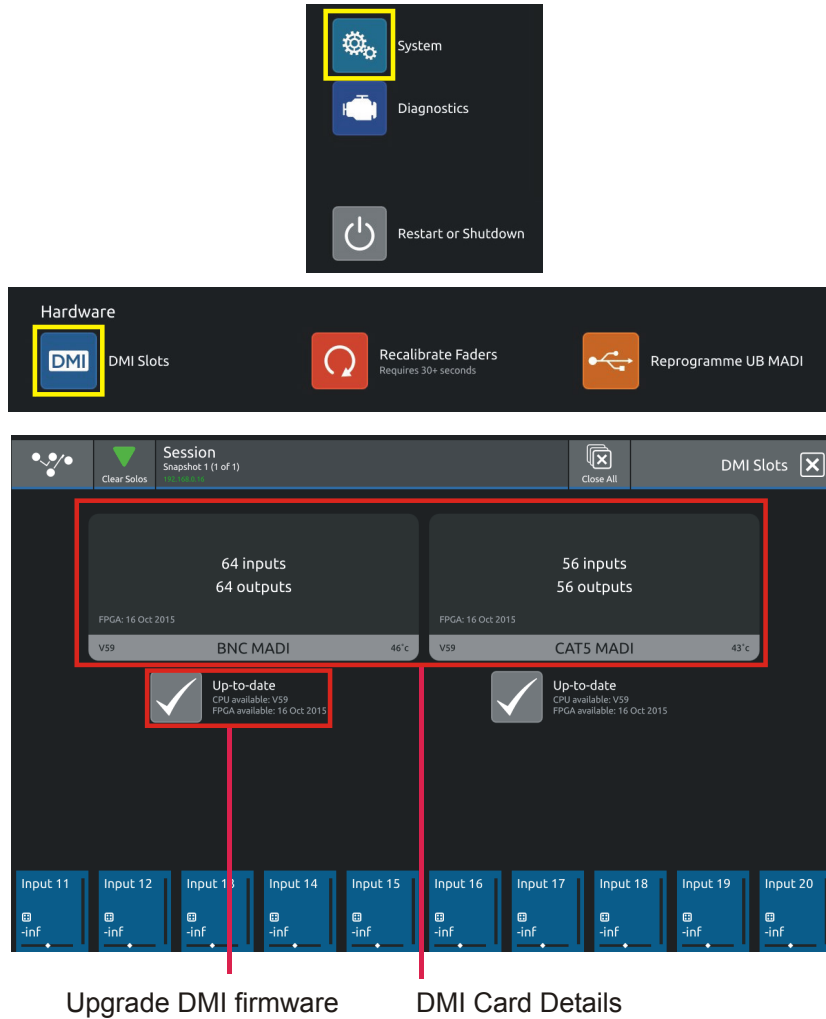



### 2.3 DMI-DANTE Cards

A DMI-Dante card in S21 provides 64 input and 64 output channels at 48KHz and 32 input and 32 output channels at 96KHz. It is provided with Primary and Secondary (backup) Gigabit Ethernet ports for connection to the Dante network.



All control and configuration of the Dante interface is done externally by the Dante controller software. A separate control computer must be provided to do this.

In S21, the Dante network can be set to use the console as the network system clock (in the Dante Controller software) or the Dante card can be selected as the console clock source.

In the picture below, the Dante Controller software displays two DiGiCo DMI Dante devices.

The second device in the list is installed in an S21 and has been manually labelled "DiGiCo S21".

In the Dante Device Config tab the S21 DMI-Dante card must be set to match the S21 sample rate at 48KHz or 96KHz

#### Example 1 - Console is Master clock for Dante Network

In the Dante Clock Status tab, the S21 DMI-Dante card is set to Sync To External and Preferred Master.

This setup enables the DMI-Dante in the S21 to take its Audio Sync Source from the console itself and in turn provide sync to the rest of the Dante network. The console would typically be set as Audio Master in the Main Menu > Audio Sync panel

Sample Rate

Device Name	Sync	Mute	Clock Source	Primary Status	Secondary Status	AE567 Status	Preferred Master	Enable Sync To External
DiGiCoDMT	<input checked="" type="checkbox"/>	<input type="checkbox"/>	Dante	Slave	N/A	N/A	<input checked="" type="checkbox"/>	<input checked="" type="checkbox"/>
DiGiCoS21	<input checked="" type="checkbox"/>	<input type="checkbox"/>	External Clock	Master	N/A	N/A	<input checked="" type="checkbox"/>	<input checked="" type="checkbox"/>

Display Preferred Master & Sync To External

Set Preferred Master & Sync To External

S21 Master Audio Sync

#### Example 2 - Dante Network is Master clock for console

If the console is required to use the Dante network as its sync source the following settings should be applied.

Enable Sync to External = OFF

Device Name	Sync	Mute	Clock Source	Primary Status	Secondary Status	AE567 Status	Preferred Master	Enable Sync To External
DiGiCoDMT	<input checked="" type="checkbox"/>	<input type="checkbox"/>	Dante	Master	N/A	N/A	<input checked="" type="checkbox"/>	<input checked="" type="checkbox"/>
DiGiCoS21	<input checked="" type="checkbox"/>	<input type="checkbox"/>	Dante	Slave	N/A	N/A	<input type="checkbox"/>	<input type="checkbox"/>

Sync To External = OFF

S21 External DMI Sync

## 2.4 DMI - ADC - DAC - AES Cards



The DMI-ADC card provides 16 analogue inputs on 2 x 25 way "D" connectors  
 The ADC card is a line card only. There is no microphone amplifier or phantom power available.  
 S21 has no gain control function for these inputs (only digital trim). Maximum input level +22dBu

The DMI-DAC card provides 16 analogue outputs on 2 x 25 way "D" connectors  
 DAC card is line level only. Maximum output level +22dBu (Digital Full Scale)

DMI-AES cards provide 16 Inputs (8 pairs) and 16 outputs (8 pairs) on 2 x 25 way "D" connectors  
 All AES inputs are provided with sample rate conversion (SRC) by default.  
 All AES outputs are synchronised to the mixer system clock.

### Multi-Pin Connector Pinouts

The DMI module range use 25 way "D" connectors, Female on the module (Male required on the connecting cable). The pins connections are as follows.

#### Analogue inputs and outputs

Sorted by pin		Sorted by function	
Function	pin	Function	pin
8+	1	0	2
0	2	0	5
7-	3	0	8
6+	4	0	11
0	5	0	16
5-	6	0	19
4+	7	0	22
0	8	0	25
3-	9	1-	12
2+	10	1+	24
0	11	2-	23
1-	12	2+	10
nc	13	3-	9
8-	14	3+	21
7+	15	4-	20
0	16	4+	7
6-	17	5-	6
5+	18	5+	18
0	19	6-	17
4-	20	6+	4
3+	21	7-	3
0	22	7+	15
2-	23	8-	14
1+	24	8+	1
0	25	nc	13

#### AES-EBU combined in/out

Sorted by pin		Sorted by function	
Function	pin	Function	pin
4out+	1	0	2
0	2	0	5
3out-	3	0	8
2out+	4	0	11
0	5	0	16
1out-	6	0	19
4in+	7	0	22
0	8	0	25
3in-	9	1in-	12
2in+	10	1in+	24
0	11	1out-	6
1in-	12	1out+	18
nc	13	2in-	23
4out-	14	2in+	10
3out+	15	2out-	17
0	16	2out+	4
2out-	17	3in-	9
1out+	18	3in+	21
0	19	3out-	3
4in-	20	3out+	15
3in+	21	4in-	20
0	22	4in+	7
2in-	23	4out-	14
1in+	24	4out+	1
0	25	nc	13

#### Pinout and connection notes:

0 = earth/ground or screen/shield    nc = not connected    + = phase/hot    - = antiphase/cold

Analogue connections for input and output are connected in the same way, as shown  
 Analogue connections for channels 1-8 shown, channels 9-16 follow the same pattern (1 = 9, 2 = 10 etc.)

AES connections are shown as 4 stereo (2 channel) connections, equivalent to channels 1-8  
 AES connections for stereo connections 1-4 (ch 1-8) shown, connections stereo 5-8 (ch 9-16) follow the same pattern (1 = 5, 2 = 6 etc.)