

CC Series Amplifier Model CC4041

Installation and Use Manual

NOTICE: Every effort was made to ensure that the information in this guide was complete and accurate at the time of printing. However, information is subject to change.

WARNING: To reduce the risk of Fire or Electric Shock, Do Not Expose this apparatus to rain or moisture.

Apparatus shall not be exposed to dripping or splashing and no objects filled with liquids, such as vases shall be placed on the apparatus.

WARNING: Only connect unit to AC mains outlet providing protective earthing connection.

NOTE: Mains plug is used as disconnect device from the mains and shall remain readily accessible and operable.



CAUTION: These servicing instructions are for use by qualified service personnel only. To reduce the risk of electric shock, do not perform any servicing other than that contained in the operating instructions unless you are qualified to do so.

CAUTION: DO NOT INSTALL OR PLACE THIS UNIT IN A BOOKCASE, BUILT-IN CABINET, OR IN ANOTHER CONFINED SPACE. ENSURE THE UNIT IS WELL VENTILATED. TO PREVENT THE RISK OF SHOCK OR FIRE HAZARD DUE TO OVERHEATING, ENSURE THAT CURTAINS AND ANY OTHER MATERIALS DO NOT OBSTRUCT THE VENTILATION VENTS.

Always follow these basic safety precautions when installing and using the unit:

IMPORTANT SAFETY INSTRUCTIONS

1. Read these instructions.
2. Keep these instructions.
3. Heed all warnings.
4. Follow all instructions.
5. Do not use this apparatus near water.
6. Clean unit with dry cloth.
7. Do not block any ventilation openings. Install in accordance with the manufacturer's instructions.
8. Do not install near any heat sources such as radiators, heat registers, stoves, or other apparatus (including amplifiers) that produce heat.
9. Do not defeat the safety purpose of the polarized or grounding-type plug. A polarized plug has two blades with one wider than the other. A grounding-type plug has two blades and a third grounding prong. The wide blade, or the third prong, are provided for your safety. If the provided plug does not fit into your outlet, consult an electrician for replacement of the obsolete outlet.
10. Protect the power cord from being walked on or pinched particularly at plugs, convenience receptacles, and the point where they exit from the apparatus.
11. Only use attachments/accessories specified by the manufacturer.
12. Unplug this apparatus during lightning storms or when not used for long periods of time.
13. Refer all servicing to qualified service personnel. Servicing is required when the apparatus has been damaged in any way, such as power-supply cord or plug is damaged, liquid has been spilled or objects have fallen into the apparatus, the apparatus has been exposed to rain or moisture, does not operate normally, or has been dropped.

<p>CAUTION RISK OF ELECTRIC SHOCK DO NOT OPEN</p>	<p>CAUTION: TO PREVENT THE RISK OF ELECTRIC SHOCK, DO NOT REMOVE ANY FRONT/BACK COVERS OR PANELS. NO USER-SERVICEABLE PARTS INSIDE. REFER SERVICING TO QUALIFIED PERSONNEL.</p>
	<p>The lightning flash with arrowhead symbol, within an equilateral triangle, is intended to alert the user to the presence of uninsulated "dangerous voltage" within the product's enclosure that may be of sufficient magnitude to constitute a risk of electric shock to persons.</p>
	<p>The exclamation point within an equilateral triangle is intended to alert the user to the presence of important operating and maintenance (servicing) instructions.</p>

Contents

Important Safety Information	2
Panel Descriptions	4-5
Front Panel	4
Rear Panel	5
Output Connections	6
Speaker Outputs	
REC Output	
Input Connections	6
Balanced- LINE/MIC Inputs (1 to 3)	
Unbalanced- Line Inputs 1 to 3	
AUX Input 4	
24V DC IN	
Operation	7
Level Controls	
Bass and Treble Controls	
LINE/MIC Selector Switch	
Mute Send	
Cooling	8
Accessories: Rack Mount Adapter	8
Limited Warranty; Exclusion of Certain Damages	8
Technical Specifications	9

Panel Descriptions

FRONT PANEL

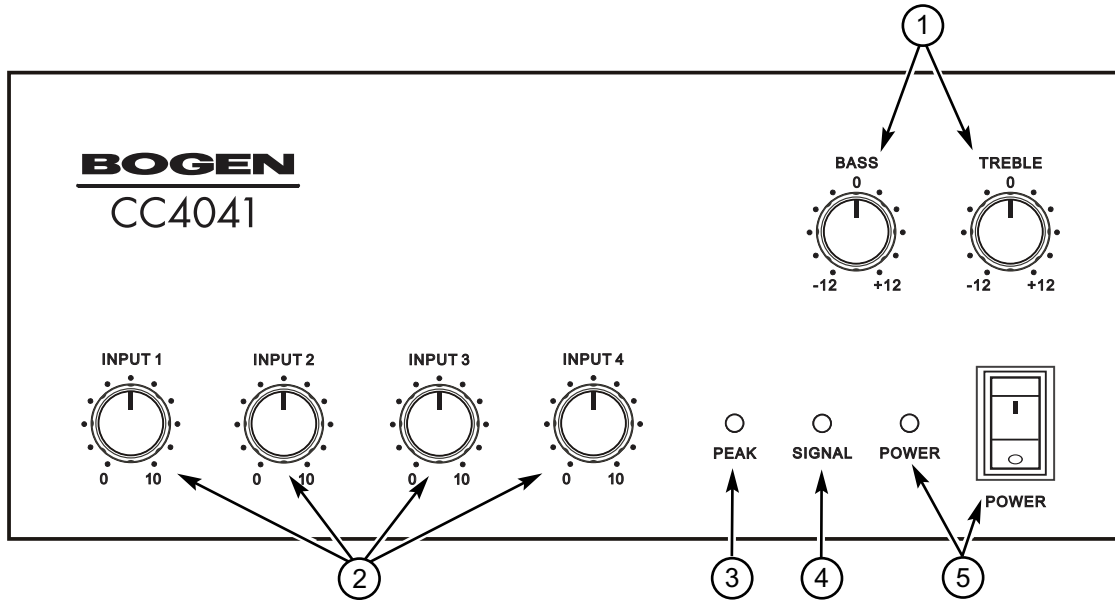

1. Bass & Treble

Separate controls for bass and treble allow adjustment of tonal quality.

2. Input Level Controls

A front-mounted level control is provided for each rear input.

3. Peak Indicator

This indicator illuminates when the amplifier reaches peak output level.

4. Signal Indicator

This indicator illuminates when a signal is present at any input.

5. Power Switch & Indicator

The amplifier power is switched on or off using this switch. The indicator illuminates when the amplifier is powered on.

Panel Descriptions

REAR PANEL

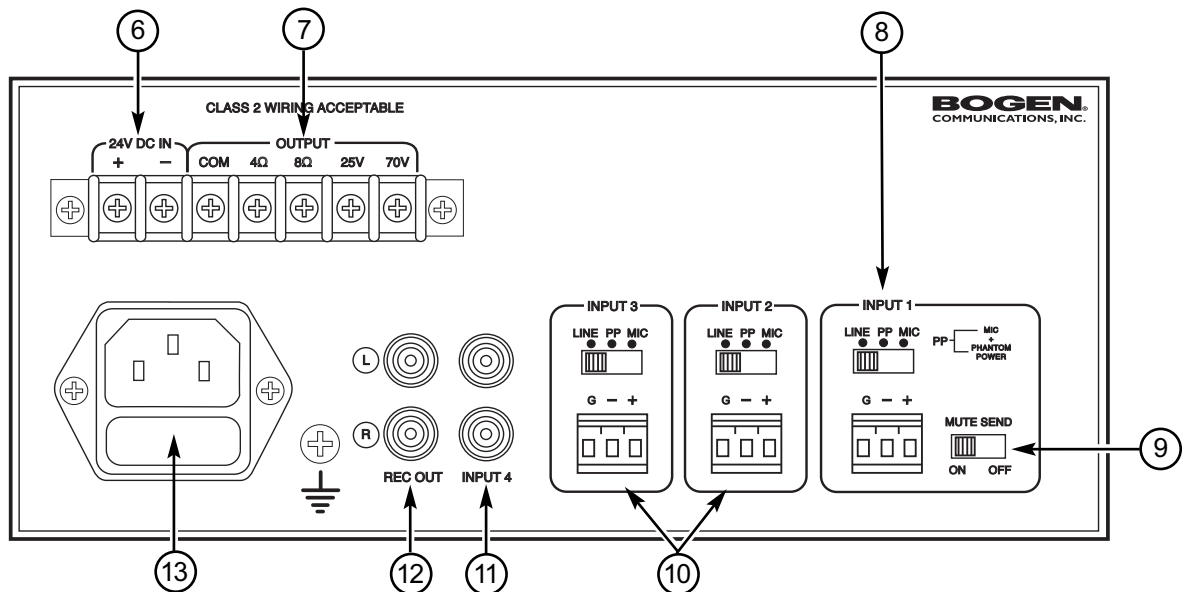

6. External DC Supply Input

Connections for an external 24V DC supply to power the amplifier.

7. Speaker Outputs

Output terminals for connection to either 70V, 25V, or low-impedance speaker types.

8. Input 1- Balanced LINE/MIC

Input 1 will provide an electronically-balanced input with selectable gain suitable for line-level signals, including dry loop telephone signals as well as balanced low-impedance microphones. The associated slide switch sets the input for LINE, MIC or PP (MIC with phantom power). This input can be set to mute Inputs 2, 3 & 4 when active.

9. Mute Send

The ability of Input 1 to mute Inputs 2, 3, and 4 can be enabled or disabled using this switch.

10. Inputs 2 & 3 - Balanced LINE/MIC

Inputs 2 and 3 will provide an electronically-balanced input with selectable gain suitable for line-level signals, including dry loop telephone signals as well as balanced low-impedance microphones. The associated slide switch sets the input for LINE, MIC or PP (MIC with phantom power). These inputs are muted by Input 1 when muting is enabled.

11. Input 4 - Unbalanced AUX

Provides a high-impedance input through a set of stereo combining RCA jacks. This input is muted by Input 1 when muting is enabled.

12. REC Output

These RCA connectors provide a signal-level output of the program material provided to the speaker.

13. AC Mains

AC mains voltage will be provided through an IEC connector with fuse holder and detachable 3-conductor IEC cord. The nominal line voltage is 120V AC, 60 Hz.

Output Connections

Speaker Outputs

The amplifier's speaker output terminal strip provides connections for 70V and 25V speaker systems, as well as low-impedance speaker loads of 4- or 8-ohm impedance. Connect one end of the speaker load to the COM terminal and the other side of the load to the terminal corresponding to the type of system being driven (transformer-coupled 70/25V speaker or low-impedance speakers without transformers).

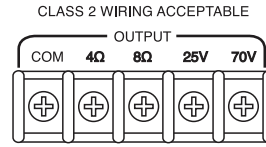

REC Output

This set of RCA connectors provide a signal-level output of the program material provided to the speaker. Both outputs supply the same mono signal (not stereo). This signal is suitable to drive recording devices or another amplifier. This output is after the Bass and Treble controls.



REC OUT

Input Connections

Balanced - LINE/MIC Inputs (1 to 3)

Inputs 1 through 3 are compatible with balanced telephone/line-level signals and microphone-level signals. Wiring for balanced MIC and balanced line signals are the same with the positive signal line going to "+", the negative going to "-" and the cable's shield going to G. The + and - designations refer only to the phase of the signal, so even if the + and - connections were reversed, the amp would still work fine. See the Operation section for details on setting the associated switches. Input 1 has the ability to mute Inputs 2, 3, and 4 when active depending on the setting of the Mute Send switch.

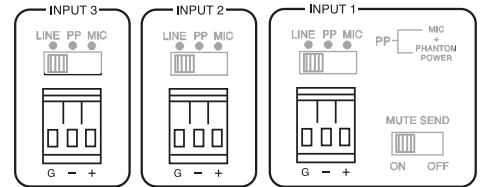

Unbalanced - LINE Inputs (1 to 3)

Inputs 1 through 3 can be wired to accept mono unbalanced signal sources. Configure a balanced input for unbalanced use by shorting the G terminal to the "-" with a small jumper wire. The unbalanced signal's hot lead is then wired to the "+" terminal and the shield is connected to the G terminal.

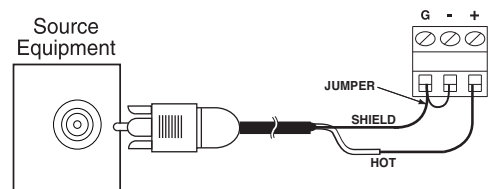

AUX Input 4

Input 4 is a stereo-combining input, compatible with unbalanced line-level (AUX) signals. This input may be muted by audio activity at Input 1 depending on the setting of the Mute Send switch.



INPUT 4

24V DC IN

The amplifier can be powered by an external power source that can supply 24V DC and at least 3 amps of current. Wire the power source to the terminals observing the polarities marked on the terminals.

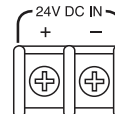

Operation

Level Controls

The amplifier provides separate input level controls on the unit front panel for rear inputs 1 through 4. Turn knobs clockwise to increase, or counterclockwise to decrease levels.

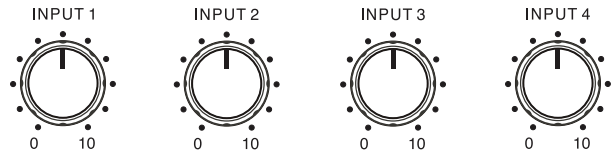

Bass & Treble Controls

Bass and treble controls are located on the front of the unit to provide tailoring of the unit's frequency response.

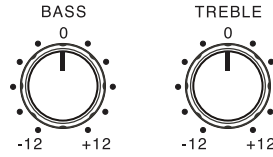

LINE/MIC Selector Switch

Input 1 provides an electronically-balanced input with selectable gain suitable for microphone and LINE/TEL level signals.

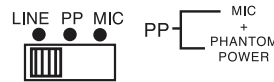

- For balanced, low-impedance microphones, the switch should be set to the MIC position.
- For balanced, condenser microphones, the switch should be set to PP which will provide phantom power to the microphone.
- For balanced line-level or telephone-level signals, the switch should be set to LINE. If using the input with an unbalanced line-level signal, the switch should also be set to LINE (see the section on input connections for instructions on unbalanced input wiring).

Mute Send

The mute send switch is used to disable Input 1 from muting Inputs 2, 3 and 4. Set this switch to ON if audio-activated muting of Inputs 2, 3 and 4 by Input 1 is desired. With this switch set to OFF, the amplifier will act as a 4 x 1 mixer with no priority override.

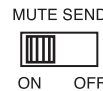

Cooling

Ventilation

The amplifier is passively cooled so care must be taken to make cool air available to the amplifier. Do not operate this amplifier in environments that get hotter than 100 deg. F. If the amplifier is to be free standing, do not remove the feet on the amp since they provide a space on the bottom of the amp for cooling air intake. Likewise do not slide books or papers under the amp which will reduce the intake area for the cooling air. Be certain not to place anything on top of the amp which will block the top ventilation slots. Keep anything mounted above the amplifier at least 1.75 inches away.

Accessories

Rack Mount Adapter

A rack mount adapter RPK93 is available to allow mounting of either a single amplifier or two amplifiers side by side. The amplifier and rack mount adapter use 2 rack spaces (2RU) of height.

NOTE: One (1) rack space both above and below the amplifier will also be needed to ensure proper ventilation.

Limited Warranty; Exclusion of Certain Damages

The **Bogen CC4041 Amplifier** is warranted to be free from defects in material and workmanship for three (3) years from the date of sale to the original purchaser. Any part of the product covered by this warranty that, with normal installation and use, becomes defective (as confirmed by Bogen upon inspection) during the applicable warranty period, will be repaired or replaced by Bogen, at Bogen's option, provided the product is shipped insured and prepaid to: Bogen Factory Service Department, 50 Spring Street, Ramsey, NJ 07446, USA. Repaired or replacement product will be returned to you freight prepaid. This warranty does not extend to any of our products that have been subjected to abuse, misuse, improper storage, neglect, accident, improper installation or have been modified or repaired or altered in any manner whatsoever, or where the serial number or date code has been removed or defaced.

THE FOREGOING LIMITED WARRANTY IS BOGEN'S SOLE AND EXCLUSIVE WARRANTY AND THE PURCHASER'S SOLE AND EXCLUSIVE REMEDY. BOGEN MAKES NO OTHER WARRANTIES OF ANY KIND, EITHER EXPRESS OR IMPLIED, AND ALL IMPLIED WARRANTIES OF MERCHANTABILITY OR FITNESS FOR A PARTICULAR PURPOSE ARE HEREBY DISCLAIMED AND EXCLUDED TO THE MAXIMUM EXTENT ALLOWABLE BY LAW. Bogen's liability arising out of the manufacture, sale or supplying of products or their use or disposition, whether based upon warranty, contract, tort or otherwise, shall be limited to the price of the product. **IN NO EVENT SHALL BOGEN BE LIABLE FOR SPECIAL, INCIDENTAL OR CONSEQUENTIAL DAMAGES (INCLUDING, BUT NOT LIMITED TO, LOSS OF PROFITS, LOSS OF DATA OR LOSS OF USE DAMAGES) ARISING OUT OF THE MANUFACTURE, SALE OR SUPPLYING OF PRODUCTS, EVEN IF BOGEN HAS BEEN ADVISED OF THE POSSIBILITY OF SUCH DAMAGES OR LOSSES.** Some States do not allow the exclusion or limitation of incidental or consequential damages, so the above limitation or exclusion may not apply to you. This warranty gives you specific legal rights, and you may also have other rights which vary from State to State.

Products that are out of warranty will also be repaired by the Bogen Factory Service Department – same address as above or call 201-934-8500. The parts and labor involved in these repairs are warranted for 90 days when repaired by the Bogen Factory Service Department. All shipping charges in addition to parts and labor charges will be at the owner's expense. All returns require a Return Authorization number. For most efficient warranty or repair service, please include a description of the failure.

12/2008

Technical Specifications

Output Power..... 40W RMS; Minimum 1 kHz @ rated distortion;
Continuous operation at 1/3 of Full Rated Power (FRP)

Frequency Response

Balanced LINE/MIC..... 100 Hz to 20 kHz; 0/-3 dB

Unbalanced Input 80 Hz to 20 kHz; 0/-3 dB

Distortion

Balanced LINE/MIC..... < 1% THD+N; Maximum, Full rated bandwidth

Unbalanced Input < 1% THD+N; Maximum, Full rated bandwidth

Output Regulation 2 dBr or better no-load to full-load

Output Impedance 70V, 25V, 4 ohms, 8 ohms

REC Output 1.14V @ FRP

Maximum Sensitivity

Balanced MIC 1.5 mVrms (200 ohms)

Balanced LINE..... 150 mVrms (200 ohms)

Unbalanced RCA Input 100 mVrms (10K ohms)

Maximum Input Level

Balanced MIC 100 mVrms

Balanced LINE..... 6 Vrms

Unbalanced Input 5 Vrms

Signal to Noise AUX

Fundamental -74 dBr minimum referenced to FRP

Balanced MIC -59 dBr minimum referenced to FRP

Balanced LINE..... -70 dBr minimum referenced to FRP

Unbalanced Input -70 dBr minimum referenced to FRP

Bass & Treble

Bass..... +/- 10 dBr @ 100 Hz referenced to mid-band

Treble +/- 10 dBr @ 10 kHz referenced to mid-band

VOX Trigger & Muting

Input 1 Trigger Level 25mV

VOX Release Delay 4 (+/- 1) sec.

Muting Level > -60 dBr

Phantom Power 12V DC min., 18V DC max.

Max. Ambient Temperature 100 deg. F (non-condensing)

Thermal Emissions 141.5 BTU/hr. (full power)

External Supply 24V DC; 3A

Dimensions 8-1/4" W x 3-1/2" H x 10-3/8" D

Product Weight 10 lb.

Listings..... Listed to UL Standard 60065 for US and Canada

Notes

Notes

BOGEN[®]
COMMUNICATIONS, INC.

50 Spring Street, Ramsey, NJ 07446, USA
Tel. 201-934-8500 • Fax: 201-934-9832
www.bogen.com