

# TASCAM

D01353920D

# DR-07X

## Linear PCM Recorder

REFERENCE MANUAL

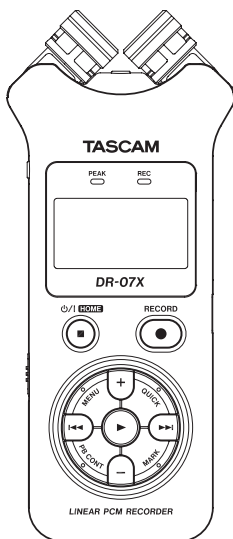

# Table of Contents

<b>1 – Introduction .....</b>	<b>4</b>	Recording .....	25
Features .....	4	Recording playback and input sounds together (overdubbing).....	25
Conventions used in this manual .....	4	Select the file you want to overdub.....	25
Trademarks and copyrights .....	5	Selecting file format .....	25
About microSD cards .....	5	Enabling overdubbing mode.....	26
Precautions for use.....	5	Adjusting the input level .....	26
<b>2 – Names and Functions of Parts .....</b>	<b>6</b>	Conducting overdubbing.....	27
Top panel.....	6	Recording automatically (AUTO REC).....	27
Front panel.....	7	Continuing to record in a new file (track incrementing).....	28
Rear panel .....	7	Manual track incrementation during recording.....	28
Left side.....	8	Automatic track incrementation by file size .....	28
Right side.....	8	Capturing a few seconds before starting recording (PRE REC).....	29
Bottom.....	8	Self-timer .....	29
Home Screen.....	9	Using tone output.....	30
Recording screen .....	10	Setting the AUTO TONE .....	30
Playback Control screen.....	10	Setting the AUTO TONE length.....	30
Menu item list .....	11	Adjusting the AUTO TONE volume.....	30
Using the menu.....	13	Recording duration.....	31
Basic operation.....	13	<b>5 – Working with Files and Folders (BROWSE screen) ....</b>	<b>32</b>
<b>3 – Preparation.....</b>	<b>14</b>	Screen navigation.....	32
Preparing the power supply.....	14	Icons on the BROWSE screen .....	32
Using AA batteries.....	14	File operations.....	32
Using an AC adapter (sold separately).....	14	Folder operations .....	33
Using USB bus power.....	14	Creating a new folder.....	33
Turning the power on and off (standby mode).....	15	<b>6 – Playback.....</b>	<b>34</b>
Turning the unit on.....	15	Adjusting the playback volume .....	34
Turning the unit off (standby).....	15	Setting the playback area (AREA).....	34
Resume function.....	15	Selecting a folder for the playback area (1).....	35
Setting the date and time .....	16	Selecting a folder for the playback area (2).....	35
Inserting and removing microSD cards.....	17	Using the playlist .....	36
Inserting microSD card.....	17	Adding files to the playlist.....	36
Removing card .....	17	Editing the playlist .....	36
Preparing microSD cards for use.....	17	Selecting files for playback (skipping).....	37
Using the built-in speaker .....	18	Playing recordings .....	37
Connecting monitoring equipment.....	18	Pausing.....	37
Using the built-in microphone .....	18	Stopping .....	37
Setting the mics to record a wide stereo sound (A-B position).....	18	Searching backward and forward .....	37
Setting the mics to record a clear stereo sound (X-Y position).....	19	Repeat playback (REPEAT).....	37
Swapping the left-right channels of the built-in microphone pair .....	19	Special playback control functions .....	38
Microphone position detection .....	19	Playback Control screen .....	38
<b>4 – Recording .....</b>	<b>20</b>	Loop playback of a selection.....	38
Setting file format, sampling frequency, type and maximum file size.....	20	Changing the playback speed (VSA) .....	39
Setting where files are saved.....	21	Setting the playback equalizer.....	39
Making input settings.....	21	Increasing the perceived overall sound pressure to enhance listenability (LEVEL ALIGN).....	40
Placing the unit and making connections .....	22	Using the jump function.....	40
Recording with the built-in mics.....	22	Setting the jump back time .....	41
Recording with external mics (MIC IN).....	22	Setting the jump forward time.....	41
Recording an external device (EXT IN).....	22	<b>7 – Quick Operations .....</b>	<b>42</b>
Adjusting the input level .....	22	Features of the QUICK button.....	42
Manually adjusting the input level .....	22	Quick menu .....	43
Using the LEVEL MODE function.....	24	Deleting files .....	43
		Dividing the selected file (DIVIDE).....	43

Overwrite recording .....	44	File name format .....	57
Selecting a file to overwrite record .....	44	Setting the WORD item .....	57
Activating overwrite recording mode .....	44	<b>14 – Messages .....</b>	<b>58</b>
Conducting overwrite recording .....	44	<b>15 – Troubleshooting .....</b>	<b>60</b>
Checking the result of recording .....	44	<b>16 – Specifications .....</b>	<b>61</b>
Undoing and redoing .....	44	General .....	61
Ending overwrite recording mode .....	44	Input/output ratings .....	61
Transcribing recorded files (DICTATION PLAY) .....	45	Analog audio input/output ratings .....	61
Enabling DICTATION PLAY mode .....	45	Control input/output ratings .....	61
Adjusting the playback equalization .....	45	Audio performance .....	61
Changing the playback position .....	45	Other specifications .....	61
Changing the playback volume and speed .....	45	Dimensional drawings .....	63
Exiting DICTATION PLAY mode .....	45		
<b>8 – Timer recording functions .....</b>	<b>46</b>		
<b>Opening the timer recording screen .....</b>	<b>46</b>		
Setting start and end times for timer recording .....	46		
Executing timer recording .....	47		
<b>9 – Mark functions .....</b>	<b>48</b>		
Adding marks manually .....	48		
Adding marks automatically to a recording .....	48		
Moving to mark positions .....	48		
Clearing marks .....	48		
<b>10 – Using the effects .....</b>	<b>49</b>		
Setting the effect .....	49		
Effects Preset List .....	49		
<b>11 – Tuning an instrument .....</b>	<b>50</b>		
Using the tuner .....	50		
Setting the tuner .....	50		
Tuning a musical instrument .....	50		
Adjusting the input level for tuning .....	50		
<b>12 – USB Connections .....</b>	<b>51</b>		
Powering the unit with USB bus power .....	51		
Using as an SD card reader .....	51		
Disconnecting the unit from a computer .....	52		
Transferring files from a computer .....	52		
Using as a USB audio interface .....	52		
Opening the AUDIO I/F screen .....	52		
Setting the connected device type .....	53		
Connecting .....	53		
<b>13 – Settings and Information .....</b>	<b>54</b>		
Viewing information (INFORMATION) .....	54		
File information page (FILE) .....	54		
Card information page .....	54		
System information page .....	54		
System Settings .....	55		
Setting the automatic power saving function .....	55		
Setting the backlight .....	55		
Adjusting the display contrast .....	55		
Setting the battery type .....	55		
Set the language .....	55		
Restoring the factory settings .....	56		
Formatting microSD cards .....	56		
Completely formatting SD cards .....	56		
Setting the file name format .....	57		

# 1 – Introduction

## Features

- Compact audio recorder that uses microSD/microSDHC/microSDXC cards as recording media
- High-performance stereo unidirectional microphone pair
- Stereo recording with different qualities is possible by opening or closing the mic pair  
Closed (X-Y): clear stereo sound with less phase difference  
Open (A-B): wide stereo sound
- 44.1/48/96 kHz, 16/24-bit, linear PCM (WAV format) recording possible
- BWF format WAV files supported
- 32–320 kbps MP3 format recording possible (compatible with v2.4 ID3 tags)
- Overdubbing allows playback and input signals to be mixed and recorded together as a new file
- Built-in 0.3 W mono output speaker
- Built-in effect (reverb) can be used during recording and playback
- Automatic recording function starts recording automatically when a set sound input level is detected
- When a maximum file size set in advance is reached, a new file can be started automatically without interrupting recording
- **QUICK** button provides easy access to various functions
- Track incrementing function allows a recording to be split by creating a new file when desired
- Pre-recording function allows the unit to record 2 seconds of sound before recording is activated
- Automatic peak reduction function automatically reduces the level suitably when the input level is too high
- Automatic level control can increase or decrease the recording volume when the input sound is too quiet or loud
- Limiter function automatically reduces the level suitably in parts when the input level is too high
- Low cut filter convenient for reducing low-frequency noise
- VSA function can change playback speed in a range from 50-200% (0.5 to 2.0 in 0.1 increments) of normal without changing pitch
- Repeat playback and IN-OUT loop playback functions
- **PB CONT** button opens screen for playback speed and IN-OUT loop settings
- Tuner function to tune musical instruments
- Self-timer function to start recording after a set period of time
- Jump function that moves backward or forward a small amount during playback or when paused (DICTATION PLAY mode only)
- Playlist function
- DIVIDE function allows files to be split where desired (only for WAV files)
- MARK function convenient for moving to specific locations
- Playback equalizer function and level alignment function to enhance the perceived overall sound pressure

- File name format can be set to use a user-defined word or the date
- Resume function to memorize the playback position before the unit is turned off
- 3.5mm (1/8") jack for external stereo microphone input (provides plug-in power) or external stereo line input
- 3.5mm (1/8") line/headphone output jack
- 128x64-pixel LCD with backlight
- Micro-B type USB 2.0 port
- Operates on 2 AA batteries, a TASCAM PS-P520E AC adapter (sold separately) or USB bus power
- Tripod attachment screw hole
- USB audio interface functions
- Dictation playback mode
- Overwrite recording function

## Conventions used in this manual

The following conventions are used in this manual.

- When we refer to a button or connector or control on the DR-07X, the typeface looks like this: **MENU**.
- When we show messages, for example, that appear on the unit's display, the typeface looks like this: **0H**.
- We abbreviate "microSD memory card" as "microSD card".
- Words that appear on the computer display are shown in quotation marks like this: "DR-07X".
- Additional information is provided as necessary in tips, notes and cautions.

### TIP

These are tips about how to use the unit.

### NOTE

Notes provide additional explanations for special situations.

### CAUTION

Failure to follow these instructions could result in damage to equipment or lost recording data, for example.

### CAUTION

Failure to follow these instructions could result in injury.

## Trademarks and copyrights

- TASCAM is a registered trademark of TEAC Corporation.
- The microSDXC Logo is a trademark of SD-3C, LLC.



- The MPEG Layer-3 audio coding technology is licensed from Fraunhofer IIS and Thomson.
- Supply of this product does not convey a license nor imply any right to distribute MPEG Layer-3 compliant content created with this product in revenue-generating broadcast systems (terrestrial, satellite, cable and/or other distribution channels), streaming applications (via Internet, intranets and/or other networks), other content distribution systems (pay-audio or audio-on-demand applications and the like) or on physical media (compact discs, digital versatile discs, semiconductor chips, hard drives, memory cards and the like). An independent license for such use is required. For details, please visit <http://mp3licensing.com>.
- ASIO is a trademark of Steinberg Media Technologies GmbH.



- Other company names, product names and logos in this document are the trademarks or registered trademarks of their respective owners.

**Information is given about products in this manual only for the purpose of example and does not indicate any guarantees against infringements of third-party intellectual property rights and other rights related to them. TEAC Corporation will bear no responsibility for infringements on third-party intellectual property rights or other liabilities that occur as a result of the use of this product.**

**Properties copyrighted by third parties cannot be used for any purpose other than personal enjoyment and the like without the permission of the right holders recognized by copyright law. Always use this equipment properly. TEAC Corporation will bear no responsibility for rights infringements committed by users of this product.**

## About microSD cards

This unit uses microSD cards for recording and playback. A list of microSD cards that have been confirmed for use with this unit can be found on the TEAC Global Site (<http://teac-global.com>). Check the page for this product. You can also contact TASCAM customer support service.

## Precautions for use

microSD cards are delicate media.

In order to avoid damaging a card or the card slot, please take the following precautions when handling them.

- Do not leave them in extremely hot or cold places.
- Do not leave them in extremely humid places.
- Do not let them get wet.
- Do not put things on top of them or twist them.
- Do not hit them.
- Do not remove or insert them during recording, playback, data transmission or other access.
- Always put memory cards in cases when transporting them.

## 2 – Names and Functions of Parts

### Top panel

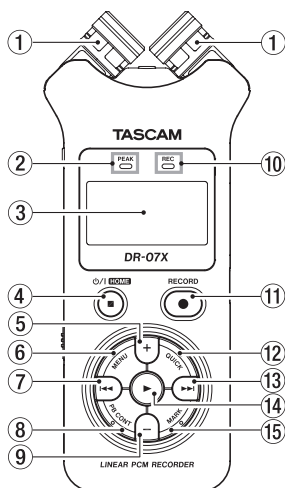

#### ① Built-in stereo microphone

This is a stereo pair of unidirectional electret condenser mics. You can set the microphones to open (A-B) or closed (X-Y).

If you connect an external microphone or external input to the **MIC/EXT IN** jack between the mics, the built-in mic pair becomes inactive.

#### ② PEAK indicator

Lights when the input volume is too high.

#### ③ Display

Displays a variety of information.

#### ④ **⏏/| (HOME) [■] button**

Press during playback to pause playback at the current position. Press when paused to return to the beginning of the track.

Press when recording or in recording standby to stop recording.

When any other screen is open, press to return to the Home Screen.

Press and hold to turn the unit on and off (put into standby).

#### ⑤ **+ button**

When the Home or **TUNER** screen is open, press to increase the output level from the built-in speaker or **Ω/LINE OUT** jack. During adjustment, a volume indicator will appear in a pull-up window.

When the Playback Control screen is open, press to increase the playback speed.

When a setting screen is open, use this button to change the setting of the selected item.

#### ⑥ **MENU button**

When the Home Screen is open, press this to open the **MENU** screen.

Press this button to return to the **MENU** screen from the various setting screens.

When the **IN** and **OUT** points are set in the track and the Playback Control screen is open, press this to turn loop playback on or off.

#### ⑦ **◀◀ button**

Press to return to the beginning of a track that is playing or stopped in the middle.

When **IN** and **OUT** points are set between the current position and the end of the track, press this button to skip to those points.

Press when a track is stopped at its beginning to skip to the beginning of the previous track.

Press and hold to search backwards.

Press this button while pressing and holding the **MARK** button to return to the previous mark.

On the setting screens, use this button to move the cursor left. Use this button to answer "NO" to a confirmation message.

On the **BROWSE** screen, press this button to move up a level.

Press when recording or in recording standby to decrease the input level from the built-in microphone or **MIC/EXT IN** jack. During adjustment, a pull-up with meters showing the input level will appear at the bottom of the display.

#### ⑧ **PB CONT button**

This button activates the Playback Control screen.

When the Playback Control screen is open, press to return to the Home Screen.

Press during recording standby to turn off the self-timer function or change the time period.

#### ⑨ **- button**

When the Home or **TUNER** screen is open, press to decrease the output level from the built-in speaker or **Ω/LINE OUT** jack.

During adjustment, a volume indicator will appear in a pull-up window.

When the Playback Control screen is open, press to increase the playback speed.

When a setting screen is open, use this button to change the setting of the selected item.

#### ⑩ **REC indicator**

This flashes during recording standby.

This lights while recording.

#### ⑪ **RECORD [●] button**

When stopped, press this button to put the unit into recording standby. The **REC** indicator will start to blink.

When in standby, press to start recording. The **REC** indicator will light when recording.

When recording, press to pause recording.

### 12 QUICK button

When playing back, stopped, paused or in recording standby when the Home Screen is open or when the Playback Control screen is open, press this button to display the Quick menu. The functions shown depend on the state of the unit when the button is pressed.

- Stopped: DELETE, DIVIDE and LEVEL ALIGN functions for the current song
- Playing back or on Playback Control screen: LEVEL ALIGN
- Recording standby: LEVEL MODE

When recording, press this button to increment the track, dividing the recording by creating a new file.

When the BROWSE screen or PLAYLIST screen is open, press this button to open or close the pop-up menu for file/folder operations.

### 13 ►► button

Press this button during playback or when playback is stopped to skip to the beginning of the next track.

When IN and OUT points are set between the current position and the end of the track, press this button to skip to those points.

Press and hold to search forward.

On the setting screens, use this button to move the cursor right. Use this to confirm the selection of a setting item or to answer "YES" to a confirmation message.

Press this button while pressing and holding the **MARK** button to move to the next mark.

On the BROWSE screen, press this button to move down a level. If a file is selected, the file is loaded, the Home Screen reopens and the unit stops.

Press this button during recording or recording standby to increase the input level from the built-in microphone or **MIC/EXT IN** jack. During adjustment, a pull-up with meters showing the input level will appear at the bottom of the display.

### 14 ► button

When the Home Screen is open and playback is stopped, press to start playback.

During playback, press this button to start jump-back playback.

When a file or folder is selected on the BROWSE screen, press this button to return to the Home Screen and play the file or the first file in the folder from the beginning.

### 15 MARK button

Use to add marks manually during recording and playback.

Press when stopped at a mark location to delete that mark.

Press the ◀◀ or ►► button while pressing and holding this button to move to the previous or next mark, respectively. When the Playback Control screen is open, use this button to set the IN (start) and OUT (end) points of the interval that you want to set for loop playback.

When the IN and OUT points are already set, press this button to cancel loop playback and clear the IN and OUT points.

## Front panel

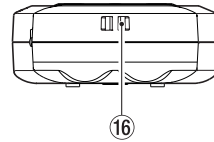

### 16 Strap holder

Use this to attach a strap.

## Rear panel

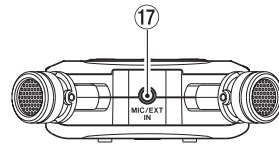

### 17 MIC/EXT IN jack

Use this input jack to connect a stereo mini-jack microphone or an external input device. This supports plug-in power.

The built-in mic is disabled when an external mic is connected to the **MIC/EXT IN** jack.

## 2 – Names and Functions of Parts

### Left side

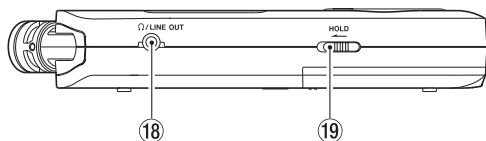

#### 18 1/8" LINE OUT jack

Use this to connect headphones or the line input jack of other equipment using a stereo mini-jack cable.

#### 19 HOLD switch

Shift to the left end (in the direction of the arrow) to engage the hold function.

No buttons can be used when **HOLD** is active.

### Right side

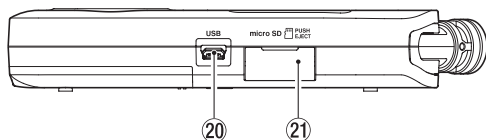

#### 20 USB port

This is a Micro-B USB port.

Use a USB cable (A to Micro-B) to connect the unit to a computer. (See "12 – USB Connections" on page 51)

#### CAUTION

The unit should be connected directly to the computer, not through a USB hub.

#### 21 microSD card slot

Use this slot to insert and remove microSD cards.

### Bottom

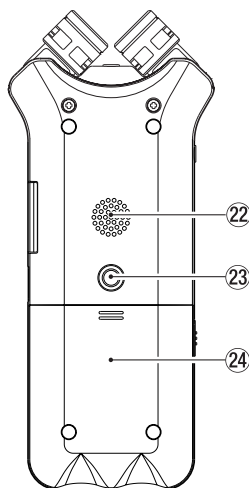

#### 22 Mono speaker

Use this built-in speaker to listen to recordings.

Sound is not output during recording, when the unit is in recording standby, when headphones are connected, when the speaker is disabled, or when in overdubbing mode.

#### 23 Tripod attachment screw thread (1/4-inch)

Use this to attach the unit to a tripod or mic stand.

#### CAUTION

- Ensure the tripod or microphone stand screws are securely fastened to prevent the unit from falling off.
- When attaching this unit to a tripod or microphone stand, be sure to place it on a level surface.

#### 24 Battery compartment cover

#### 25 Battery compartment

Install batteries (2 AA) in this compartment to power the unit. (See "Using AA batteries" on page 14)

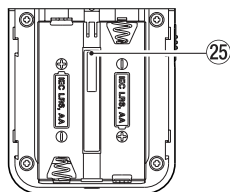



### Home Screen

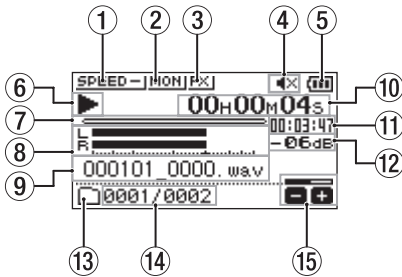

Home Screen when in ordinary operation mode

#### ⑥ Recorder operation status

This icon shows the recorder operation status.

Icon	Explanation
■	Stopped
▶	Paused
▶	Playing back
▶▶	Searching forward
◀◀	Searching backward
▶▶	Skipping to the beginning of the next file
◀◀	Skipping to the beginning of the current or previous file

#### ① Playback speed status

One of the following icons appears according to the playback speed setting.

Icon	Playback speed
SPEED —	x1.0
SPEED ▲	x1.1 – x2.0
SPEED ▼	x0.5 – x0.9
SPEED X	Playback speed not controllable

#### ② Monitor Mix status

This shows the Monitor Mix function status.

MON: Monitor Mix disabled

MON: Monitor Mix enabled

#### ③ Effect status

Shows whether the effect function is ON or OFF.

FX: Built-in effect off

FX: Built-in effect on

#### ④ Speaker status

⊗: Speaker output off

⊕: Speaker output on

#### ⑤ Remaining battery charge/power supply status

A battery icon appears when power is supplied by batteries.

When batteries are being used, a battery icon shows the amount of power remaining in bars (100%, 75%, 50%).

The batteries are almost dead and the power will soon turn off (standby) if the 0% icon with no bars appears.

When using a TASCAM PS-P520E AC adapter (sold separately) or USB bus power, ⚡ appears.

#### NOTE

Sometimes a "Battery Low" warning appears when recording or conducting other demanding operations even when battery power remains.

#### ⑦ Playback position display

The current playback position is shown by a bar. As playback progresses, the bar extends from the left.

#### ⑧ Playback level meters

These show the levels of the input and playback signals.

When in overdubbing mode, the levels of the mixed input and playback sounds are shown.

#### ⑨ Playback file name

The name or tag information of the file currently in play is displayed.

The ID3 tag information is displayed instead when included in the MP3 file.

#### NOTE

ID3 tag information contains titles and artist names, which can be stored in MP3 files.

#### ⑩ Elapsed time

Shows the elapsed time (hours: minutes: seconds) of the currently playing track.

#### ⑪ Remaining time message

Shows the remaining playback time of the current track (hours: minutes: seconds).

#### ⑫ Peak value in decibels (dB)

The maximum level that occurs in a fixed period of time is displayed digitally.

#### ⑬ Playback area

This shows the current playback file area.

📁: All files in the MUSIC folder

📁: All files in the selected folder

📁: All files added to the playlist

#### ⑭ Playback file number/total number of files

This shows the current file number and total number of files in the playback area.

#### ⑮ Output volume status

This shows the output volume status.

## 2 – Names and Functions of Parts

### Recording screen

The recording screen shown below appears when recording or in recording standby.

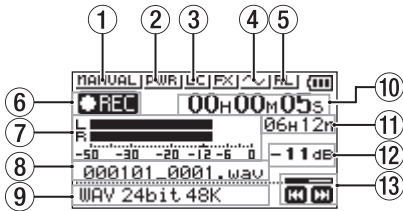

#### 1 Level mode setting status

This icon shows the level mode function setting.

**MANUAL**: MANUAL  
**LIMITER**: LIMITER  
**PEAK**: PEAK REDUCTION  
**AUTO**: AUTO

#### 2 Plug-in power status

This shows whether plug-in power is on or off.

**PWR**: Plug-in power off  
**PWR**: Plug-in power on

#### 3 Low cut filter status

This shows whether the low cut filter is on or off.

**LC**: Low cut filter off  
**LC**: Low cut filter on

#### 4 AUTO TONE setting status

This icon shows whether the AUTO TONE function is on or off.

**AUTO TONE**: AUTO TONE off  
**AUTO TONE**: AUTO TONE on

#### 5 Built-in stereo microphone left-right setting

When not correct for the mic angle setting, the current left-right setting of the built-in stereo mics is shown.

Icon	Mic angle	MIC LR SWAP
<b>LR</b>	Closed (X-Y)	L-R
<b>RL</b>	Open (A-B)	R-L

#### 6 Recording status

This icon shows the recorder operation status.

Icon	Explanation
<b>●   </b>	Recording paused (recording standby)
<b>REC</b>	Recording

#### 7 Recording level meters

The input signal levels are shown.

In overdubbing mode, the levels of the mixed input and playback sounds are shown.

#### 8 Recording file name

The file name that will automatically be given to the recorded file is shown.

#### 9 Recording format

This shows the file recording format and sampling frequency.

#### 10 Elapsed recording time

The elapsed recording time of the file appears as hours: minutes: seconds.

#### 11 Remaining recording time

When stopped, this shows the remaining time (hours: minutes) of the microSD card. When the remaining recording time becomes less than one minute, only seconds will be shown.

#### 12 Peak value in decibels (dB)

Peak input level values are shown in decibels.

#### 13 Recording level status

This shows the recording level status.

### Playback Control screen

During playback or when stopped, press the **PB CONT** button to open the Playback Control screen.

Recording is not possible when this screen is open. Use the **I◀** and **▶I** buttons to skip to IN/OUT points and the file beginning/end. You cannot skip to the previous or next file.

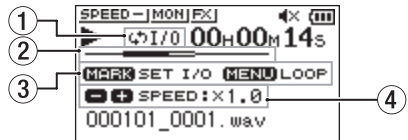

#### 1 Loop playback status

The **I/O** icon appears when loop playback is enabled.

#### 2 Playback position

The current playback position is shown by a bar. As playback progresses, the bar extends from the left.

#### 3 Available buttons

The buttons available in the Playback Control screen are as follows.

**MARK**: Creates or deletes an IN or OUT point.

**MENU**: Turn loop playback ON or OFF.

#### 4 Playback speed

Playback speed as compared with the normal speed is shown. **VSA** appears on the left when variable speed audition, which allows tempo to be changed without changing pitch, is enabled.

### Menu item list

Press the **MENU** button to open the MENU screen. The menu items are as follows.

Menu item		Function	Page
REC SETTING	FORMAT	Set the recording format	see page 20
	SAMPLE	Set the sampling frequency	
	CHANNEL	Set stereo or mono file	
	SIZE	Set the maximum file size	
	MIC POWER	Set plug-in power	see page 21
	LOW CUT	Set the low-cut filter	see page 21
	PRE REC	Set the pre-recording function	see page 29
	AUTO TONE	Set tone output	see page 30
	TONE SECS	Set the length of the output tone	see page 30
	TONE VOL	Set the volume of tone output	see page 30
	MODE	Set the auto-recording function mode	see page 27
	LEVEL	Set the auto-recording start level	see page 27
PLAY SETTING	AREA	Set the playback area	see page 34
	REPEAT	Set the repeat playback function	see page 37
	JUMP BACK	Set the jump back function	see page 41
	JUMP FWD	Set the jump forward function	see page 41
I/O SETTING	LEVEL MODE	Set the level mode function	see page 24
	SPEAKER	Turn the built-in speaker on/off	see page 18
	PLAYEQ	Set the playback equalization	see page 39
	LEVEL ALIGN	Set the output level alignment function	see page 40
BROWSE		Work with files and folders on the SD card	see page 32
TIMER REC	START TIME	Set the starting time for the timer recording function	see page 46
	END TIME	Set the ending time for the timer recording function	
	TIMER	Set the execution of the timer recording function	see page 47
OVERDUBBING	MODE	Set the overdubbing mode	see page 26
	PB LEVEL	Set the playback level when in overdubbing mode	
USB	SD CARD READER	Select the SD card reader mode	see page 51
	AUDIO I/F	Make USB audio interface settings	see page 52
OTHERS	INFORMATION	Information about the file, microSD card, and system	see page 54
	TUNER	Use the tuner	see page 50
	EFFECT	Make effect settings	see page 49
	FILE NAME	Set the recording file name	see page 57
	DATE/TIME	Set the date and time used by the unit	see page 16

## 2 – Names and Functions of Parts

Menu item		Function	Page
SYSTEM	AUTO PWR SAVE	Set the automatic power saving function	see page 55
	BACKLIGHT	Set the backlight	see page 55
	CONTRAST	Adjust the display contrast	see page 55
	BATTERY TYPE	Set the type of batteries.	see page 55
	LANGUAGE	Set the language shown on the display	see page 55
	INITIALIZE	Restore the default settings	see page 56
	QUICK FORMAT	Format an SD card	see page 56
	FULL FORMAT	Completely format an SD card	see page 56

### CAUTION

- When recording or in recording standby, only the following screens and items are shown.
  - REC SETTING screen: MIC POWER, LOW CUT and AUTO REC items (AUTO REC setting cannot be changed)
  - OVERDUBBING screen: MODE and PB INPUT items (MODE setting cannot be changed)
  - EFFECT screen: all items
- When the Playback Control screen is open, pressing the **MENU** button will not open the MENU screen. This turns the loop playback function on/off. (See “Loop playback of a selection” on page 38)

### Using the menu

We will explain this by showing how to set the playback area as an example.

1. Press the **MENU** button to open the **MENU** screen.

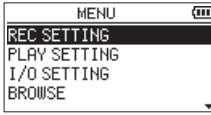

2. Use the + or – button to select a menu item (highlighted), and use the ► button to move to various settings screens.

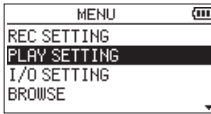

Example: **PLAY SETTING** screen

3. Use the + or – button to select (highlight) a menu item to set.

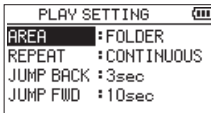

Example: **AREA** is selected.

4. Use the ► or ►► button to move the cursor to highlight the value of the setting.

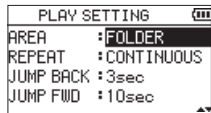

5. Use the + or – button to change the setting.
6. Press the ◀◀ button to set a different item in the same menu.  
This enables selection of a different item. Use the + or – button to select another item to set.
7. Repeat step 3 to 6 as necessary to set other items.
8. Press the **MENU** button to open the **MENU** (or **OTHERS**) screen. To return to the Home Screen, press the ⏪/1 (**HOME**) [■] button.

### Basic operation

Use the following buttons to operate the various screens.

#### MENU button

This opens the **MENU** screen.

#### PB CONT button

This opens the Playback Control screen.

#### ⏪/1 (**HOME**) [■] button

When a settings screen is open, press the ⏪/1 (**HOME**) [■] button to return to the Home Screen.

#### ► button

Use to confirm the various setting items.

#### ►► button

Use this to move the cursor (highlighted area) right on the screen and to open folders on the **BROWSE** screen.

Use this to answer "YES" to a pop-up confirmation message.

#### ◀◀ button

Use this to move the cursor (highlighted area) left on the screen and to close folders on the **BROWSE** screen.

Use this to answer "NO" to a confirmation pop-up message.

#### + button

Use this to move the cursor (highlighted area) up on the screen and to increase values.

#### – button

Use this to move the cursor (highlighted area) down on the screen and to decrease values.

#### QUICK button

This opens the Quick menu.

The content differs according to the recorder status and operation mode.

## 3 – Preparation

### Preparing the power supply

This unit can operate on two AA batteries, using a TASCAM PS-P520E AC adapter (sold separately) or using a commercially-available USB cable (USB bus power). Alkaline or Ni-MH batteries can be used.

To use USB bus power, see “Powering the unit with USB bus power” on page 51.

### Using AA batteries

Open the battery compartment cover on the back of the unit. Fit two AA batteries to the + and – marks shown in the compartment, and close the battery compartment cover.

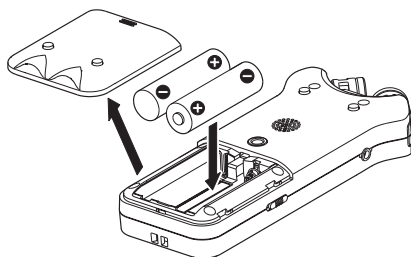

When using AA batteries, set the type of battery in order to accurately show the amount of power remaining and allow the unit to accurately determine whether power is available for proper operation. (See “Setting the battery type” on page 55)

#### CAUTION

- Do not use manganese dry cell batteries.
- This unit cannot recharge Ni-MH batteries. Use a commercially available recharger.
- The included alkaline batteries are for confirming operation of the unit and might not last very long.

### Using an AC adapter (sold separately)

As shown in the illustration, connect a TASCAM PS-P520E AC adapter (sold separately) to the unit’s **USB** port and charge the unit.

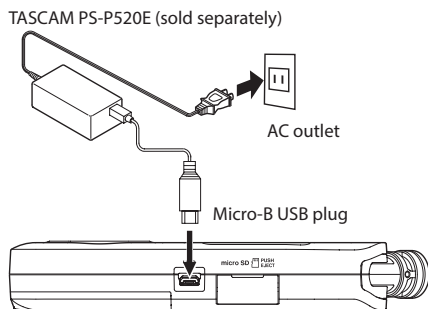

#### CAUTION

- Never use any adapter other than the designated PS-P520E AC adapter. Use of a different adapter could cause malfunction, fire or electric shock.
- Noise may occur when recording with a microphone if the unit is too close to the AC adapter. In such a case, keep sufficient distance between the AC adapter and the unit.

#### NOTE

When both batteries are installed and the AC adapter is connected, power will be supplied from the AC adapter.

### Using USB bus power

Use the commercially-available USB cable to connect the unit and the computer as illustrated below.

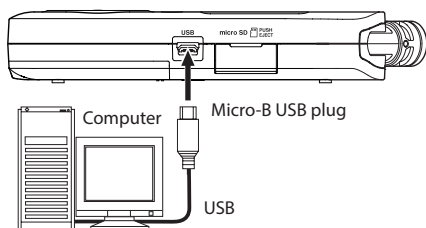

See “Powering the unit with USB bus power” on page 51.

## Turning the power on and off (standby mode)

### CAUTION

Do not wear connected headphones when turning the unit on or off (putting it in standby). Noise could damage the headphone driver unit or harm your hearing.

### CAUTION

- The unit enters standby mode if turned off when the unit is operating on AC power supplied through an AC adapter (TASCAM PS-P520E, sold separately) or bus power from a computer USB port.
- Turn down the volume of the monitoring system connected to the unit before turning the unit on/off (standby).

## Turning the unit on

When the unit is off (in standby), press and hold the  $\phi/1$  (HOME) [■] button until the TASCAM DR-07X start-up screen is shown on the display.

The Home Screen appears after the unit starts up.



Start-up screen

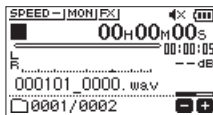

Home Screen

### CAUTION

The first time a new unit is turned on after purchase, the following settings must be made.

- 1) A screen to set the display language will open.



Press the + or – button to move the cursor and select (highlight) the language to be shown on the display.

### Options

- English: use English
- 日本語: use Japanese
- Français: use French
- Español: use Spanish
- Deutsch: use German
- Italiano: use Italian
- Português: use Portuguese
- РУССКОЕ: use Russian
- 中文: use Chinese
- 한글: use Korean

After selection, press the ► button to confirm it. You can change this setting with the SYSTEM screen LANGUAGE item. (See “Set the language” on page 55)

- 2) A screen for setting the built-in clock will open.



Press the ◀◀ or ▶▶ button to move the cursor (highlighted area), and use the + or – button to change values.

Press the ► button to fix the settings.

The start-up screen is displayed, and then the Home Screen appears after the unit has started up.

Date/time adjustment may be skipped (and made later) by pressing the ► button. (See “Setting the date and time” on page 16)

## Turning the unit off (standby)

Press and hold the  $\phi/1$  (HOME) [■] button until LINEAR PCM RECORDER appears on the display.

The unit turns off (puts it in standby) after it completes its shutdown process.



### CAUTION

Always use the  $\phi/1$  (HOME) [■] button to shut down the unit.

Do not remove the batteries or disconnect the power cable (TASCAM PS-P520E AC adapter or USB cable) while the unit is on. If power is interrupted, the unit cannot shut down properly and all recordings, settings and other data will be lost. Lost data and settings cannot be restored.

## Resume function

The unit has a resume function. When turned on, the unit locates to the position (time) where it was when turned off previously.

If the ► button is pressed after start-up, the track the unit was playing when turned off previously resumes playing from the position (time) where it was before the unit was turned off.

### NOTE

The required data are stored on the microSD card. The resume function does not work if the card is exchanged or formatted.

## 3 – Preparation

### Setting the date and time

The DR-07X uses its internal clock to record the date and time to the recorded files.

1. Press the **MENU** button to open the **MENU** screen.

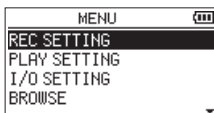

2. Use the + or – button to select (highlight) **OTHERS** and press the ► button.

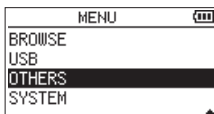

The **OTHERS** screen opens.

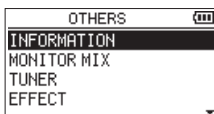

3. Use the + or – button to select the **DATE/TIME** menu item, and press the ► button.

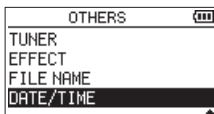

The **DATE/TIME** screen opens.

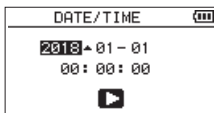

4. Press the ◀◀ or ▶▶ button to move the cursor (highlighted area), and use the + or – button to change values.
5. Press the ► button to confirm the change and return to the **OTHERS** screen.

#### NOTE

You can set the unit to automatically add the date to file names. (See "Setting the file name format" on page 57)

#### CAUTION

The date and time setting can be retained for only a few minutes when power is not supplied from batteries, a dedicated AC adapter (TASCAM PS-P520E; sold separately) or USB bus power.

When using batteries, we recommend replacing them before they are completely dead.



## Inserting and removing microSD cards

### Inserting microSD card

1. Open the microSD slot cover on the right side.
2. Insert the microSD Card into the slot as shown in the following illustration until it clicks into place.

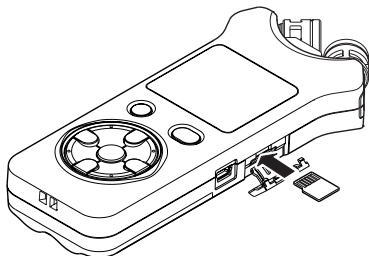

### Removing card

1. Open the microSD slot cover on the right side.
2. Press the microSD card in gently and then release it to allow it to come out.

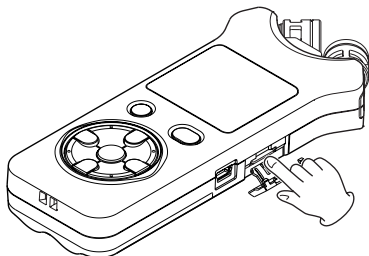

#### CAUTION

- Do not remove the microSD card from the unit when it is connected to a computer by USB.
- The DR-07X is compatible with microSD/microSDHC/microSDXC standards.
- A list of microSD cards that have been confirmed for use with this unit can be found on the TEAC Global Site (<http://teac-global.com>).

## Preparing microSD cards for use

In order to use a microSD card in this unit, you must format it first.

1. Confirm that a microSD card is installed and turn the power ON.
2. The following message appears when a new card or a card formatted for use with another device is installed in the unit.

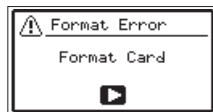

3. Press the ► button to start formatting.

#### CAUTION

Formatting a card erases all the data on it.

4. When formatting ends, the Home Screen opens. You can also reformat the card in this unit at any time.

#### CAUTION

When formatting a card, the unit should be operating on power supplied by a PS-P520E adapter (sold separately), computer USB bus power or batteries with sufficient remaining power.

## 3 – Preparation

### Using the built-in speaker

To listen to the playback sound from the built-in speaker, turn on the **SPEAKER** item on the **I/O SETTING** screen.

#### NOTE

Even if **SPEAKER** is enabled, the unit will not play through the speaker when the unit is recording sound, in recording standby or muted with headphones or an external speaker system connected.

### Operation from the MENU screen

1. Press the **MENU** button to open the MENU screen.
2. Use the + or – button to select (highlight) the **I/O SETTING** and press the ► button. The **I/O SETTING** screen will open.
3. Use the + or – button to select (highlight) the **SPEAKER** item and press the ► or ►► button.

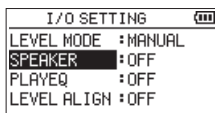

4. Use the + or – button to select **ON**.

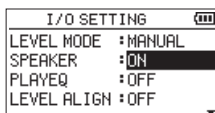

5. After completing the setting, press the **HOME** button to return to the Home Screen.

### Operation from the Quick menu

1. During playback when the Home Screen is open, press the **QUICK** button to open the Quick menu.



2. Use the + or – button to select (highlight) the **SPEAKER** item and press the ► button. The **SPEAKER** screen will open.

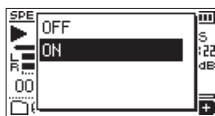

**Options:** OFF, ON (default)

3. Use the + or – button to select (highlight) a setting, and press the ► button to enable it and return to the Home Screen.

### Connecting monitoring equipment

To listen with headphones, connect them to the **LINE OUT** jack.

To listen with an external monitoring system (powered monitor speakers or an amplifier and speakers), connect it to the **LINE OUT** jack.

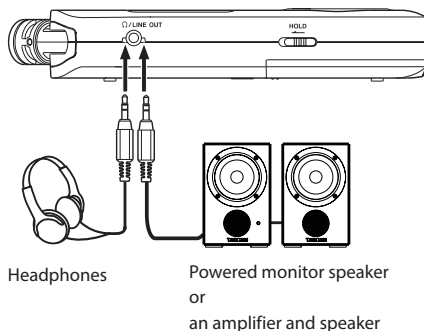

Headphones

Powered monitor speaker  
or  
an amplifier and speaker

### Using the built-in microphone

This unit's built-in microphones can be adjusted, allowing the angles of the microphones to be changed. You can choose clear stereo sound or wide stereo sound according to considerations including the recording source and situation by opening or closing the microphone pair.

### Setting the mics to record a wide stereo sound (A-B position)

Open the mics to the left and right (A-B position).

Set this way, the two microphones are spread wide to the left and right, enabling recording with a strong stereo field that is good for music, for example.

If you open or close the microphone pair while using the built-in stereo microphone and the left-right setting does not suit the angle of the microphone, a pop-up message appears to ask whether you want to change the mic left-right setting. (See "File information page (FILE)" on page 54)

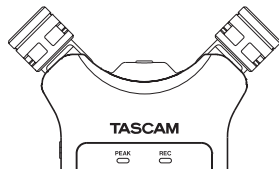

#### CAUTION

Set the built-in stereo mic to setting to L-R.

When using the built-in stereo microphone in an open state and the left-right setting is not L-R, **RL** appears as light on dark on the Home Screen. (See "Adding marks manually" on page 48)

## Setting the mics to record a clear stereo sound (X-Y position)

Close the mics (X-Y position).

This setting enables recording with a clear stereo field and less phase difference.

If you open or close the microphone pair while using the built-in stereo microphone and the left-right setting does not suit the angle of the microphone, a pop-up message appears to ask whether you want to change the mic left-right setting. (See “File information page (FILE)” on page 54)

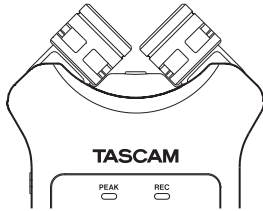

### CAUTION

Set the built-in stereo mic to setting to R-L.

When using the built-in stereo microphone in a closed state and the left-right setting is not R-L, **RL** appears as light on dark on the Home Screen. (See “Adding marks manually” on page 48)

## Swapping the left-right channels of the built-in microphone pair

Swap the left and right mics according on the mic angle setting.

When the microphone pair is open, the left mic should be set to the left channel and the right mic should be set to the right channel (A-B position: L-R). When the microphone pair is closed, the left mic should be set to the right channel and the right mic should be set to the left channel (X-Y position: R-L).

When using the built-in stereo microphone and this setting is not set, **RL** appears as light on dark on the Home Screen.

1. Press the **RECORD** [●] button to begin recording standby.  
The **REC** indicator flashes red and the recording screen opens.
2. Press the **QUICK** button.  
The Quick menu will open.

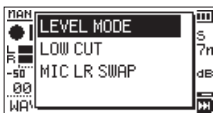

3. Use the + or – button to select (highlight) **MIC L-R SWAP**, and press the ► button.  
The L-R swap pop-up screen will open.

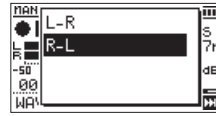

4. Use the + button or – button to select (highlight) L-R or R-L according to the **MIC** pair angle.
5. Press the ► button to fix the setting, and to return to the Home Screen.

## Microphone position detection

The following pop-up message appears automatically whenever the built-in stereo mic is opened or closed and the left-right channel setting does not suit the mic angle.



Press the ►► button to change the setting.

Press the ◀◀ button to leave the setting as it is.

### NOTE

- This screen appears automatically when the left mic is opened or closed. If only the right microphone is opened or closed, it does not appear.
- When you change the microphone angle setting and the pop-up message appears, you must press the ►► button to change the L-R setting, press the ◀◀ button to keep this setting as is, or restore the previous microphone angle to close the pop-up message before you can begin recording.
- The pop-up message does not appear if you change the microphone position when recording. If necessary, use the **MIC L-R SWAP** setting by pressing the **QUICK** button to switch the setting after change the setting to recording standby mode by pressing the **RECORD** [●] button. (See “Swapping the left-right channels of the built-in microphone pair” on page 19)

## 4 – Recording

In addition to the built-in microphone, an external microphone or external audio device (i.e. CD player) can also be used for recording. You can select among MP3 (44.1/48 kHz, 32–320 kbps) and WAV (44.1/48/96 kHz, 16/24-bit) audio recording formats.

Since the unit is compatible with the BWF format for WAV files, marks added to WAV files during recording are available when playing them back with BWF-compatible software, for example.

With this unit, you can mix and record a sound input through the built-in mic or the input jack with an audio file that is played back using the overdubbing function.

### Setting file format, sampling frequency, type and maximum file size

Select the audio file type that you want to record before you start recording.

1. Press the **MENU** button to open the **MENU** screen.
2. Use the + or – button to select (highlight) the **REC SETTING** menu item, and press the **▶** button.

The **REC SETTING** screen opens.

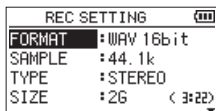

3. Use the + or – button to select (highlight) **FORMAT**, and press the **▶▶** or **▶** button.

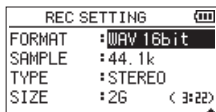

Set the recording format here.

Set the file format with the + or – button to one of the following options.

**Options:** WAV 16bit (default), WAV 24bit, MP3 32k, MP3 64k, MP3 96k, MP3 128k, MP3 192k, MP3 256k, MP3 320k

#### NOTE

- WAV formats provide better recording quality than MP3.
- MP3 formats enable longer recording times than WAV.
- MP3 formats with higher values provide better recording quality.

4. Press the **◀◀** button to enable selection of settings.
5. Use the + or – button to select (highlight) **SAMPLE**, and press the **▶▶** or **▶** button.

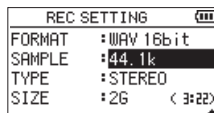

Set the sampling frequency.

Use the + or – button to select 44.1k (default), 48k or 96k.

#### NOTE

96k cannot be selected if **FORMAT** is set to MP3.

6. Press the **◀◀** button to enable selection of settings.
7. Use the + or – button to select (highlight) **TYPE**, and press the **▶▶** or **▶** button.

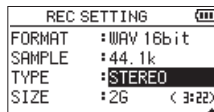

Now, select stereo or mono file type.

Use the + or – button to select **STEREO** (default) or **MONO**. If **MONO** is selected, a mono file is created, and the same signals are sent to both L and R level meters and output channels.

If set to record in **MONO** in WAV format, the file size will be half that when recorded in **STEREO**, allowing longer recording times.

8. Press the **◀◀** button to enable selection of settings.
9. Use the + or – button to select (highlight) **SIZE**, and press the **▶▶** or **▶** button.

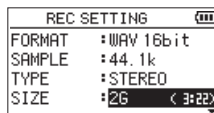

Set the maximum file size with the + or – button to 64M, 128M, 256M, 512M, 1G or 2G (default),

#### NOTE

- If the maximum set file size is exceeded during recording, the unit will automatically continue recording in a new file.
  - Depending on the file format, the amount of recording time will differ for the same file size. The amount of recording time is shown to the right of the setting value (in parentheses).
  - If the recording time exceeds 24 hours, the unit will automatically continue recording in a new file.
10. After completing the setting, press the **⏪** (**HOME**) **[■]** button to return to the Home Screen.

## Setting where files are saved

Set the folder where recorded files are saved.

Recorded files will be saved in the currently selected folder. For details, see the **SELECT** pop-up menu item in “Folder operations” on page 33.

If no setting is made, new recording files are created in the **MUSIC** folder.

## Making input settings

1. Press the **MENU** button to open the **MENU** screen.
2. Use the + or – button to select (highlight) the **REC SETTING** menu item, and press the **▶** button. The **REC SETTING** screen opens.

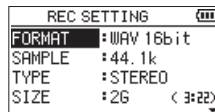

The following input settings are made on this screen.

Set each item using the **◀◀**, **▶▶**, **+** and **-** buttons.

### MIC POWER

When connecting a microphone that requires plug-in power, set this to **ON**. (Default: **ON**)

### LOW CUT

Set the cutoff frequency of the low-cut filter during input.

**Options:** OFF (default), 40Hz, 80Hz, 120Hz, 220Hz

### CAUTION

- Set **MIC POWER** to **OFF** when connecting a dynamic microphone, microphone with a built-in battery, or external audio device. If set to **ON**, the plug-in power may damage such microphones or generate noise.
- Use headphones to monitor when you are recording with a microphone. If you use speakers to monitor, the sound output from the speakers may also be recorded, causing a poor recording and even feedback.

### NOTE

**MIC POWER** and **LOW CUT** can be set even when recording or in recording standby.

### TIP

- The low cut filter can reduce noise such as unpleasant wind noise from air-conditioners and projectors.
- Use the built-in effects of this unit as necessary on the input source. (See “Setting the effect” on page 49)

### Placing the unit and making connections

#### Recording with the built-in mics

Point the mics at the sound source and place the unit in a stable location where there is little vibration.

#### Recording with external mics (MIC IN)

Connect an external mic to the **MIC/EXT IN** connector.

Point the mic at the sound source and place the unit in a stable location where there is little vibration.

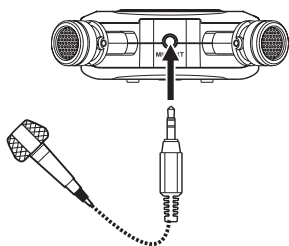

#### NOTE

The setting of left-right channels is disabled if an external mic is connected to the **MIC/EXT IN** jack.

#### Recording an external device (EXT IN)

Use a stereo miniplug cable to connect to the output of an external audio device.

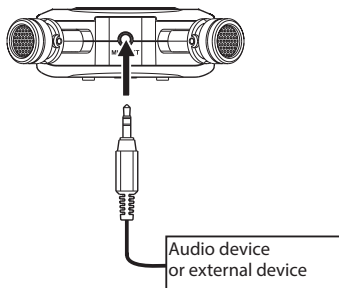

#### CAUTION

- If the input sound is still distorted after adjusting the input level of the unit, reduce the playback sound of the external device.
- If an external audio device with a fixed output line level is connected, it might not be possible to control the gain level of excessively loud input signals. In such cases, use the headphone jack or other level-controllable output for connection to the unit.

#### NOTE

The setting of left-right channels is disabled if an external mic is connected to the **MIC/EXT IN** jack.

### Adjusting the input level

Before starting recording, the input level should be adjusted to prevent the recorded sounds from being distorted due to excessively loud input signals or from being inaudible due to excessively small input signals being masked by noise.

In addition to making manual adjustments, you can use the available limiter, automatic peak reduction and automatic level adjustment functions as you like.

#### TIP

In addition to adjusting the **INPUT** level, try changing the distance and angle between the microphone and the sound source. The angle and distance of the microphone can also change the character of the recorded sound.

### Manually adjusting the input level

The input level can be adjusted.

To adjust the input level manually, the **LEVEL MODE** function must be set to **MANUAL**.

#### Setting the LEVEL MODE function on the MENU screen

1. Press the **MENU** button to open the **MENU** screen.
2. Use the + or – button to select (highlight) the **I/O SETTING** menu item, and press the ► button. The **I/O SETTING** screen will open.

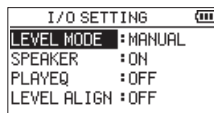

3. Use the + or – button to select (highlight) the **LEVEL MODE** and press the ► button.

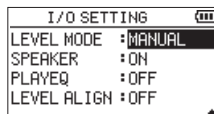

4. Use the + or – button to change the **LEVEL MODE** setting to **MANUAL**.
5. When setting is complete, press the ⏪ (**HOME**) button to return to the Home Screen.

## Setting the LEVEL MODE function from the Quick menu

1. Press the **RECORD** [●] button to begin recording standby.  
The **REC** indicator flashes red and the recording screen appears.
2. Press the **QUICK** button to open the quick menu.



3. Use the + or – button to select (highlight) **LEVEL MODE**, and press the ► button.  
This opens the **LEVEL MODE** setting screen.



4. Use the + or – button to change the **LEVEL MODE** setting to **MANUAL**.
5. Use the + or – button to select (highlight) a mode, and press the ► button to enable the mode and return to the recording screen.  
The selected mode is shown with an icon on the recording screen.

## Adjusting the input level

1. Press the **RECORD** [●] button to begin recording standby.  
The **REC** indicator flashes red and the recording screen appears.

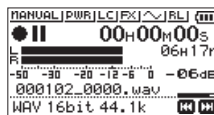

2. Use the ◀◀ or ▶▶ button to adjust the input level.  
Press the ◀◀ or ▶▶ button to show a pull-up **MENU** screen for input level setting.

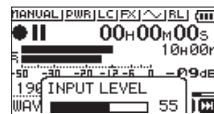

If the input is too high, the **PEAK** indicator on the upper left above the display lights.

A ▲ mark is provided at -12dB on the level meters. Set the input level so that the indicator bars fluctuate centered on this mark without causing the **PEAK** indicator to light red when the loudest sounds occur.

### NOTE

- Press the ◀/I (HOME) [■] button to exit recording standby.
- When in recording standby or recording, the speaker will not output sound even if the I/O SETTING screen **SPEAKER** setting is on.

If you need to monitor sound to adjust the input level and make recordings, connect the headphone to the ◀/LINE OUT jack.

Use the + or – button on the Home Screen to adjust the monitoring volume. This does not affect the sound to be recorded.

### Using the LEVEL MODE function

#### Operation from the MENU screen

1. Press the **MENU** button to open the MENU screen.
2. Use the + or – button to select (highlight) the **I/O SETTING** menu item, and press the ► button. The **I/O SETTING** screen will open.
3. Use the + or – button to select (highlight) the **LEVEL MODE** and press the ► button.

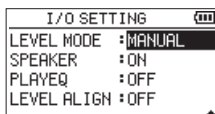

4. Use the + or – button to set the **LEVEL MODE** function.  
**Options:** **MANUAL** (default), **LIMITER**, **PEAK REDUCTION**, **AUTO LEVEL**
5. After completing the setting, press the **⏪/1 (HOME) [■]** button to return to the Home Screen.

#### Operation from the Quick menu

1. Press the **RECORD [●]** button to begin recording standby. The **REC** indicator flashes red and the recording screen opens.
2. Press the **QUICK** button. The Quick menu will open.

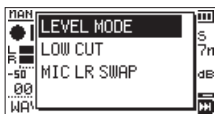

3. Select (highlight) **LEVEL MODE**, and press the ► button. This opens the **LEVEL MODE** setting screen.

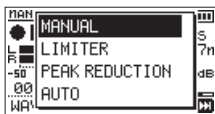

**Options:** **MANUAL** (default), **LIMITER**, **PEAK REDUCTION**, **AUTO LEVEL**

4. Use the + or – button to select (highlight) a mode, and press the ► button to enable the mode and return to the recording screen. The selected mode is shown with an icon in the recording screen.

#### MANUAL

Manually adjusting the input level

#### LIMITER

This function prevents distortion when signals that are too loud are input suddenly.

This mode is also suited for recording live performances with large volume changes.

In this mode, the input level can be changed manually during recording.

#### CAUTION

Distortion of sounds may occur when excessively large input signals are input even if the **LIMITER** function is activated. In such a case, lower the input level or increase the distance between the unit and the source.

#### PEAK REDUCTION

If the input sound is too loud, the input level is automatically lowered to a suitable level. This function makes handling difficult input level settings easier.

The input level can be raised manually if required.

#### TIP

When recording live performances, for example, you could test **PEAK REDUCTION** before the actual recording.

Select the **PEAK REDUCTION** mode in recording standby, and maximize the input level. By conducting a rehearsal performance, the input gain will be reduced to an appropriate level for recording, setting an optimum input level for the performance.

This set input level can be used for recording by turning this mode off before starting recording. Otherwise, the input level will continue to be adjusted automatically in response to the input signal during recording.

#### AUTO LEVEL

Low input levels are raised and high input levels are lowered automatically, making this useful for recording meetings, for example. In this mode, the recording level cannot be changed manually.



## Recording

The following operation procedures assume that the input source is set, input level adjustment is complete, and the Home Screen is open.

1. Press the **RECORD** [●] button to begin recording standby.

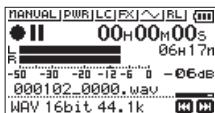

The screen shows the recording file name, the recording audio file type and sampling frequency. Confirm that these are as desired before starting recording.

2. To start recording, press the **RECORD** [●] button again. Normal recording starts.

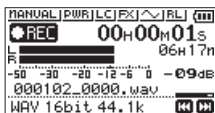

When recording starts, the **REC** indicator lights continuously, and the display shows the elapsed recording time and the remaining recording time.

3. To stop recording, press the **HOME** [■] button. To pause recording, press the **RECORD** [●] button. Press the **RECORD** [●] button again to restart recording in the same file.

If you press the **HOME** [■] button while paused, a recorded audio file up to the moment that you paused recording is created.

### CAUTION

Noise may occur when recording with a microphone if the unit is too close to the AC adapter. In such a case, keep sufficient distance between the AC adapter and the unit.

## Recording playback and input sounds together (overdubbing)

By overdubbing, you can play an instrument or sing as you play back a saved track and mix and record both sounds in a new file.

### NOTE

- The prerecording function is disabled when in overdubbing mode.
- The auto-recording function is disabled when in overdubbing mode.
- When overdub recording, you cannot start new files manually.
- Pausing is not possible in overdubbing mode (**RECORD** [●] button is disabled).
- The sampling frequency of the playback file is preserved regardless of the sampling frequency setting for overdub recording.
- You cannot make an mp3 file when overdubbing a WAV file with a sampling frequency of 96kHz.

## Select the file you want to overdub

Use the **◀** and **▶** buttons and the **BROWSE** screen to select that files that you want to overdub.

### NOTE

See "5 – Working with Files and Folders (BROWSE screen)" on page 32 for selecting files using the **BROWSE** screen.

## Selecting file format

1. Press the **MENU** button to open the **MENU** screen.
2. Use the + or – button to select (highlight) the **REC SETTING** menu item, and press the **▶** button. The **REC SETTING** screen opens.

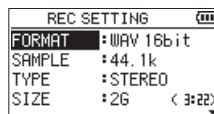

3. Use the + or – button to select (highlight) the **FORMAT** menu item, and press the **▶** or **▶** button.
4. Set the file format with the + or – button.
5. After completing the setting, press the **HOME** [■] button to return to the Home Screen.

### Enabling overdubbing mode

In overdubbing mode, the mixed input and playback sounds can be monitored.

#### CAUTION

When in overdubbing mode, sound will not be output from the speaker even if the speaker setting is on.

1. Press the **MENU** button to open the MENU screen.
2. Use the + or – button to select (highlight) the **OVERDUBBING** and press the **▶** button. The **OVERDUBBING** screen will open.

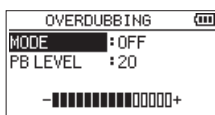

3. Use the + or – button to select (highlight) the **MODE** item, and press the **▶▶** or **▶** button.

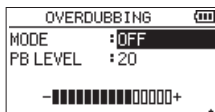

4. Use the + or – button to select **ON**. (Default: OFF)  
Monitoring of input sound is now enabled.
5. Press the **◀◀** button to enable selection of settings.
6. Use the + or – button to select (highlight) the **PB INPUT** menu item, and press the **▶▶** or **▶** button.

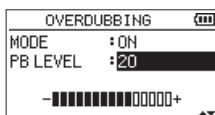

7. Use the + or – button to adjust the playback volume level.  
This can be set from 0 - 30. (Default: 20)  
When set to 20, the playback level will be the same as it was when recorded.

8. After completing the setting, press the **⏠/1 (HOME)** button to return to the Home Screen.

When in overdubbing mode, **OVERDUBBING** appears on the screen.

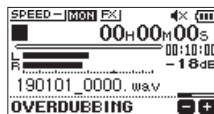

#### TIP

When in overdubbing mode, the playback control function can be used to practice singing or playing an instrument along with the playback sound.

### Adjusting the input level

When in overdubbing mode, press the **QUICK** button to enable input level adjustment.

1. Press the **QUICK** button while the Home Screen is open during playback or when stopped.  
The Quick menu will open.



Quick menu when stopped

2. While listening to the input sound, use the **◀◀** or **▶▶** button to adjust the input level.

#### CAUTION

- When the Quick menu is open, the level meters cannot be viewed while making adjustments.
- At the level when distortion of the input sound is about to occur, the **PEAK** indicator on the left above the display will light. Adjust the input level so the **PEAK** indicator does not light.

#### NOTE

When in overdubbing mode, the **PEAK** indicator lights when the combined input and playback signals become higher than the set level.

## Conducting overdubbing

1. Press the **RECORD** [●] button to begin recording standby.

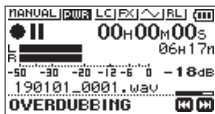

The following error message appears if the selected file cannot be played back.

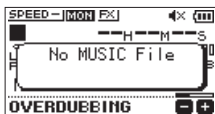

2. Press the **RECORD** [●] button to start overdubbing. Overdubbing will start. When recording starts, the **REC** indicator lights and the display shows the elapsed and remaining recording times.
3. To stop recording, press the **⏪/I (HOME)** [■] button.

## Recording automatically (AUTO REC)

This function starts and pauses recording, starts new files, and sets marks automatically according to the input signal level.

1. Press the **MENU** button to open the MENU screen.
2. Use the + or – button to select (highlight) the **REC SETTING** menu item, and press the **▶** button. The **REC SETTING** screen opens.

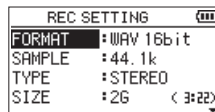

3. Use the + or – button to select (highlight) the **MODE** item, and press the **▶▶/I** or **▶** button.
4. Use the + or – button to set the **AUTO REC** mode.

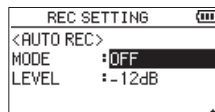

OFF (Default): Off

NEW FILE: Records and pauses automatically

MARK: Sets marks automatically during recording

5. Press the **I◀◀** button to enable selection of settings.
6. Use the + or – button to select (highlight) the **LEVEL** item, and press the **▶▶/I** or **▶** button.

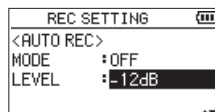

7. Use the + or – button to set the level that signal is judged to have been input to -6dB, -12dB (default), -24dB or -48dB.
8. After completing the setting, press the **⏪/I (HOME)** [■] button to return to the Home Screen.
9. Press the **RECORD** [●] button to begin recording standby. Recording starts automatically when the input signal exceeds the **LEVEL** setting.

## 4 – Recording

- Recording operation changes according to the **MODE** setting.

### NEW FILE

If the input signal level falls below the standard level set by **LEVEL** for more than five seconds, the unit enters recording standby. When the input signal level becomes higher than the standard level, the unit starts recording a new file.

### MARK

If the input signal level falls below the standard level set by **LEVEL** for more than five seconds, the unit adds a mark when the input signal level becomes higher than the standard level again.

- Press the **⏪/I (HOME) [■]** button to stop automatic recording.

### TIP

By using this in combination with the **PRE REC** function, you can record events without losing the beginnings of sounds.

### CAUTION

- The self-timer function cannot be used when using the **AUTO REC** function.
- The automatic recording function cannot be used when in overdubbing mode or during overwrite recording.

## Continuing to record in a new file (track incrementing)

Recording of the current file can be stopped and recording continued in a new file automatically. This can be done manually or when the maximum file size set on the **REC SETTING** screen is reached during recording (track incrementation function).

## Manual track incrementation during recording

During recording, you can manually start a new file and continue recording.

- Press the **QUICK** button while recording.

### NOTE

Numbers at the end of file name will increment each time when a new file is created.

### CAUTION

- A new file cannot be created if the total number of files and folders would exceed 5000.
- Files shorter than 2 seconds cannot be created. (4 seconds if the sampling frequency is 96kHz).
- If the name of a newly created file would be the same as that of an existing file, the number will be incremented until the new file has a unique name.
- Track incrementing is not possible during overdub or overwrite recording.

## Automatic track incrementation by file size

Recording of the current file can be stopped and recording continued in a new file automatically when the maximum file size set on the **REC SETTING** screen is reached during recording.

Follow the procedures below to set the maximum file size.

- Press the **MENU** button to open the **MENU** screen.
- Use the + or – button to select (highlight) the **REC SETTING** menu item, and press the **▶** button. The **REC SETTING** screen opens.

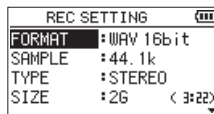

- Use the + or – button to select (highlight) the **SIZE** item, and press the **▶▶** or **▶** button. Use the + or – button to set the maximum file size at which track incrementing takes place to 64M, 128M, 256M, 512M, 1G or 2G (default).
- After completing the setting, press the **⏪/I (HOME) [■]** button to return to the Home Screen.

### CAUTION

A new file cannot be created if the total number of files and folders would exceed 5000.

### NOTE

Depending on the file format, the amount of recording time will differ for the same file size.

## Capturing a few seconds before starting recording (PRE REC)

By using prerecording, when the unit is in recording standby you can record up to two seconds of the signal input before the **RECORD** [●] button is pushed to start recording.

1. Press the **MENU** button to open the **MENU** screen.
2. Use the + or – button to select (highlight) the **REC SETTING** menu item, and press the ► button. The **REC SETTING** screen opens.
3. Use the + or – button to select (highlight) the **PRE REC** menu item, and press the ►► or ► button.
4. Use the + or – button to select **ON**. (Default: **OFF**)

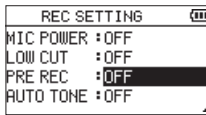

5. After completing the setting, press the **⏻/1 (HOME)** [■] button to return to the Home Screen.

### TIP

By using this in combination with the **AUTO REC** function, you can record events without losing the beginnings of sounds.

### NOTE

- If you start recording within two seconds from when the record standby mode is turned **ON**, recording will begin from the moment of record standby.
- The pre-recording function cannot be used during overdub or overwrite recording.

## Self-timer

Similar to a camera, the DR-07X has a self-timer function to begin recording after a set period of time.

1. Press the **RECORD** [●] button when stopped or playing back to set the unit in recording standby, and press the **PB CONT** button.
2. The self-timer icon ⌚ appears with the time shown to the right on the recorder status screen. Each time you press the **PB CONT** button, the setting changes as follows.  
⌚ Time shown to the right of the icon  
**OFF** (default) → **5S** (5 seconds) → **10S** (10 seconds) → **OFF**

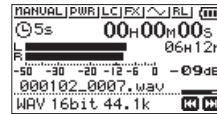

3. Set the time period, and press the **RECORD** [●] or ► button. Recording will start after the set time period.

### NOTE

- When the set time is elapsing, the **REC** indicator blinks faster.
- The self-timer cannot be used when recording is paused.
- The self-timer function cannot be used when using the **AUTO REC** function.
- During overwrite recording, the self-timer cannot be used.

## Using tone output

The tone output function can be used to automatically insert a tone signal whenever recording starts and stops.

By connecting the  $\Omega$ /LINE OUT jack on the left side of the unit and the external mic input jack of a digital SLR camera and using the auto tone function, the same tone signal will be recorded to files on both units. These tones can be used as guides when synchronizing the files in video editing software.

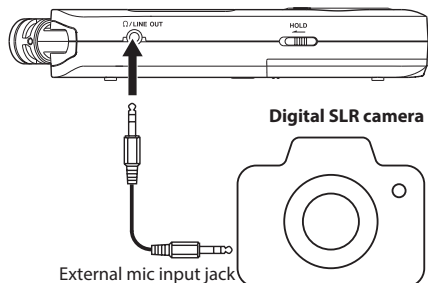

Connection example

## Setting the AUTO TONE

1. Press the **MENU** button to open the MENU screen.
2. Use the + or – button to select (highlight) the REC SETTING menu item, and press the ► button. The REC SETTING screen opens.
3. Use the + or – button to select (highlight) the AUTO TONE item, and press the ►► or ► button.
4. Use the + or – buttons to set when tone signals are inserted.

**Options:** OFF (default), HEAD (recording start only), HEAD+TAIL (recording start and stop)

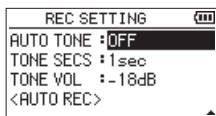

5. After completing the setting, press the  $\phi$ /I (HOME) [■] button to return to the Home Screen.

### CAUTION

- When recording is stopped by the AUTO REC function, no tone signal will be recorded when it stops.
- During overwrite recording, the automatic tone function cannot be used.

## Setting the AUTO TONE length

You can set the length of the AUTO TONE.

1. Press the **MENU** button to open the MENU screen.
2. Use the + or – button to select (highlight) the REC SETTING menu item, and press the ► button. The REC SETTING screen opens.
3. Use the + or – button to select (highlight) the TONE SECS item, and press the ►► or ► button.
4. Use the + or – buttons to set the tone length.

**Options:** 0.5sec, 1sec (default), 2sec, 3sec

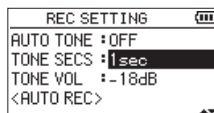

5. After completing the setting, press the  $\phi$ /I (HOME) [■] button to return to the Home Screen.

## Adjusting the AUTO TONE volume

You can adjust the volume of the AUTO TONE.

1. Press the **MENU** button to open the MENU screen.
2. Use the + or – button to select (highlight) the REC SETTING menu item, and press the ► button. The REC SETTING screen opens.
3. Use the + or – button to select (highlight) the TONE VOL item, and press the ►► or ► button.
4. Use the + or – buttons to adjust the tone volume.

**Options:** -12dB, -18dB (default), -24dB, -30dB, -36dB

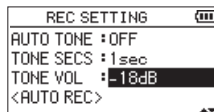

5. After completing the setting, press the  $\phi$ /I (HOME) [■] button to return to the Home Screen.

## Recording duration

The table below shows the maximum recording time on microSD/microSDHC/microSDXC cards of different capacities and recording formats.

Recording format			microSD/microSDHC/microSDXC card capacity (hours:minutes)			
			1GB	2GB	4GB	8GB
16-bit WAV (stereo)	44.1 kHz		1:41	3:22	6:44	13:28
	48 kHz		1:33	3:06	6:12	12:24
	96 kHz		0:46	1:33	3:06	6:12
24-bit WAV (stereo)	44.1 kHz		1:07	2:15	4:30	9:00
	48 kHz		1:02	2:04	4:08	8:16
	96 kHz		0:31	1:02	2:04	4:08
MP3 (stereo/mono)	32 kbps	44.1 kHz/48 kHz	74:32	149:04	298:08	596:16
	64 kbps	44.1 kHz/48 kHz	37:16	72:32	149:04	298:08
	96 kbps	44.1 kHz/48 kHz	24:50	49:40	99:20	198:40
	128 kbps	44.1 kHz/48 kHz	18:38	37:16	74:32	149:04
	192 kbps	44.1 kHz/48 kHz	12:25	24:50	49:40	99:20
	256 kbps	44.1 kHz/48 kHz	9:19	18:37	37:16	74:32
	320 kbps	44.1 kHz/48 kHz	7:27	14:54	29:48	59:36

- The recording times shown above are estimates. They might differ depending on the microSD/microSDHC/microSDXC card in use.
- The recording times shown above are not continuous recording times, but rather they are the total possible recording times for the microSD/microSDHC/microSDXC card.
- If the recording time exceeds 24 hours, the unit will automatically continue recording in a new file.
- If recorded in mono in WAV files, the maximum recording time will be double the figures above.

## 5 – Working with Files and Folders (BROWSE screen)

On the BROWSE screen, you can view the contents of the **MUSIC** Folder, which contains the audio files on the microSD card that you can use with the unit. On this screen, you can also play and erase selected audio files, create folders, add tracks to the playlist and so on. (See “Using the playlist” on page 36)

### TIP

If you connect the unit with a computer by USB or mount the microSD card on a computer using a card reader or other input, you can use the computer to change the folder structure within the **MUSIC** folder and erase files as you would the contents of a hard drive. Furthermore, you can change file names from the computer.

To open the BROWSE screen, press the **MENU** button to open the **MENU** screen. Use the + or – button to select **BROWSE** and press the ► button.

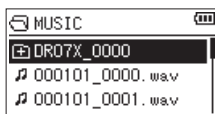

The contents of the folder that contains the file that was selected on the Home Screen before the BROWSE screen was opened appears on the display.

## Screen navigation

On the BROWSE screen, folders and music files appear in a hierarchical structure much like they would appear on a computer. Only two levels of folders can be created.

- Use the + or – button to select files and folders.
- When a folder is selected, press the ►► button to show the contents of that folder.
- When a file or folder is selected, press the ◀◀ button to exit the currently open folder and go up a level in the folder structure.
- When a file or folder is selected, press the **QUICK** button to open the pop-up window.
- When a file is selected, press the ► button to return to the Home Screen and play the file.

This folder that contains this file becomes the current folder, and new recorded file will be saved in this folder. If the playback area has been set to **FOLDER**, this folder becomes the new playback area.

- When a folder is selected, press the ► button to return to the Home Screen. The first file in the folder (shown at the top of the file list) will be played.

This folder becomes the current folder, and new recorded files will be saved in this folder. Regardless of the previous setting, the playback area is set to **FOLDER**, and this folder becomes the new playback area.

## Icons on the BROWSE screen

The meanings of icons that appear on the BROWSE screen are as follows.

### 📁 Root Music Folder (MUSIC)

The **MUSIC** Folder is the highest (root) level folder in the hierarchy shown on the BROWSE screen.

### 🎵 Audio file

The 🎵 icon appears before the names of music files.

### 📁 Plus folder

This is a folder that contains subfolders.

### 📁 Plain folder

This is a folder that does not contain subfolders.

### 📁 Open folder (📁)

The contents of the folder marked with this icon currently appear on this screen.

## File operations

Select the desired audio file on the BROWSE screen and press the **QUICK** button to open the pop-up window that is shown below.



Use the + or – button to select the item you want from the following list and press the ► button to execute it.

## INFORMATION

Information (date/time, size) about the selected file appears. Press the ◀◀ button to return to the BROWSE screen.

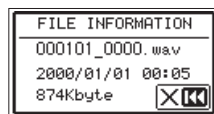



## ADD PLAYLIST

Adds the selected file to the playlist. (See “Using the playlist” on page 36)

## DELETE

A message appears to confirm that you want to delete the file.

To delete the file, press the ►► button. To cancel deletion, press the ◀◀ button.



### NOTE

The pop-up menu can also be closed by pressing the QUICK button.

## Folder operations

Select the desired folder on the BROWSE screen and press the QUICK button to open the pop-up window that is shown below.

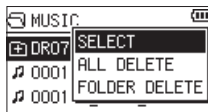

Use the + or – button to select the item you want from the following list and press the ► button to execute it.

## SELECT

Returns to the Home Screen and selects the first file in the folder. Regardless of the previous setting, the playback area is set to FOLDER, and this folder becomes the new playback area. When recording, files are created in this folder.

## ALL DELETE

A pop-up message appears to confirm that you want to delete all the files in the selected folder at once.

To delete the file, press the ►► button. To cancel deletion, press the ◀◀ button.



## FOLDER DELETE

A pop-up message appears to confirm immediate deletion of the selected folder and all files in it.

Press the ►► button to delete the folder and all files in it. Press the ◀◀ button to cancel deletion.

### NOTE

- You cannot erase read-only files and files that are not recognized by this unit.
- The pop-up menu can also be closed by pressing the QUICK button.

## Creating a new folder

In the file list, NEW FOLDER appears at the bottom.

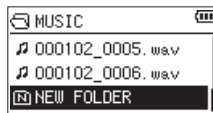

Select (highlight) NEW FOLDER, and press the ► button. It shows a message to confirm creation of a new folder.



Press the ►► button to create a new folder or press the ◀◀ button to cancel.

Since this unit supports only a two-level folder structure, the NEW FOLDER function is not available in second-level folders.

A newly created folder becomes the current folder (currently selected folder), and recorded files are saved in this folder.

If the playback area has been set to FOLDER, this folder becomes the playback area.

# 6 – Playback

On the Home Screen, you can use the ◀◀ and ▶▶ buttons to select the playback track. The files that you can select are determined by the playback area setting. Limiting the playback area makes track selection easier when you have numerous recorded and copied tracks on the microSD card. On the PLAY SETTING screen, you can select all files, the current folder or the playlist as the playback area. You can also use the BROWSE screen to set a folder as the playback area.

### NOTE

On the BROWSE screen, regardless of the playback area setting, you can select any file on the card that you want.

## Adjusting the playback volume

The volume of output through the built-in speaker or the Ω/LINE OUT connector can be adjusted using the + or – button while the Home Screen is open.

A pull-up volume indicator appears.

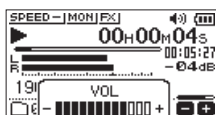

## Setting the playback area (AREA)

Set the playback area for repeat and ordinary playback on the PLAY SETTING screen.

1. Press the **MENU** button to open the MENU screen.
2. Use the + or – button to select (highlight) the **PLAY SETTING** menu item, and press the ▶ button. This opens the **PLAY SETTING** screen.

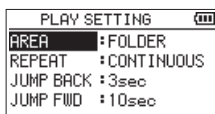

3. Use the + or – button to select (highlight) the **AREA** item, and press the ▶▶ or ▶ button.

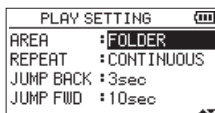

4. Use the + or – button to set the playback area.

### ALL FILES

Set the playback area as all files in the Music Folder on the microSD card.

### FOLDER (default)

Set the playback area as all the files in the currently selected folder.

### PLAYLIST

Set the playback area as the files in the playlist. (See “Using the playlist” on page 36)

If there is no playlist defined, a No PLAYLIST pop-up appears.



5. After completing the setting, press the ◀/| (HOME) [■] button to return to the Home Screen.

### NOTE

The current playback area setting appears in the lower left of the Home Screen.

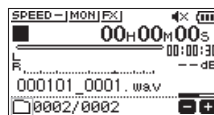

Playback area indication

## Selecting a folder for the playback area (1)

Regardless of the current playback area, if you select a folder on the BROWSE screen, the playback area changes to the selected folder.

1. Press the **MENU** button to open the MENU screen.
2. Use the + or – button to select **BROWSE**, and press the ► button.  
The BROWSE screen will open.

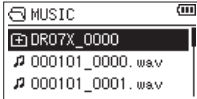

The content of the folder that contains the file selected on the Home Screen is displayed.

3. Use the ◀◀ or ▶▶ button to select a folder level, and use the + or – button to select a folder.  
For an explanation of how to use the BROWSE screen, see “Screen navigation” on page 32.
4. Press the **QUICK** button to open the following pop-up window.



Use the + or – button to select **SELECT**, and press the ► button.

The Home Screen reopens with the first file in the folder selected, and the unit is stopped.

Regardless of the previous setting, the playback area is set to **FOLDER**, and this folder becomes the playback area. This folder becomes the current folder, and new recorded files will be saved in this folder.

## Selecting a folder for the playback area (2)

When the playback area is set to **FOLDER**, if you select a file on the BROWSE screen, the folder that contains the selected file becomes the playback area.

1. Press the **MENU** button to open the MENU screen.
2. Use the + or – button to select **BROWSE**, and press the ► button.  
The BROWSE screen will open.

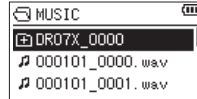

The content of the folder that contains the file selected on the Home Screen is displayed.

3. Use the ◀◀ or ▶▶ button to select a folder level, and use the + or – button to select the folder that contains the track (file) you want to play.  
For an explanation of how to use the BROWSE screen, see “Screen navigation” on page 32.
4. Press the ▶▶ button.
5. Use the + or – button to select the desired file.

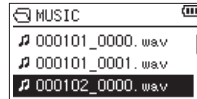

6. Press the ► button.  
The display returns to the Home Screen, and the selected track starts playing. This folder becomes the current folder, and new recorded files will be saved in this folder.  
In addition, the folder that contains this file becomes the playback area regardless of the playback area folder set previously.

## Using the playlist

You can make a list of files for playback (playlist).

On the **PLAY SETTING** screen if you select **PLAYLIST** for the **AREA** item, you can set playback to just the tracks in your playlist.

## Adding files to the playlist

1. Press the **MENU** button to open the **MENU** screen.
2. Use the + or – button to select **BROWSE**, and press the ► button.

The **BROWSE** screen will open.

### NOTE

For an explanation of how to use the **BROWSE** screen, see “5 – Working with Files and Folders (**BROWSE** screen)” on page 32.

3. Use the + or – button to select the file you want to add to the playlist, and press the **QUICK** button.  
A pop-up window appears.

### NOTE

For details about how to select the file, see “Screen navigation” on page 32.

4. Use the + or – button to select **ADD LIST**.



5. Press the ► button.  
The track is added to the playlist and the pop-up window closes.
6. Repeat steps 3, 4, and 5 as necessary to add more tracks to the playlist. The tracks are numbered in the order that they are added.

## Editing the playlist

You can view and edit the playlist you have made on the **PLAYLIST** screen. You can also use this screen to play tracks and to edit the playlist.

1. Press the **MENU** button to open the **MENU** screen.
2. Use the + or – button to select **BROWSE**, and press the ► button.  
The **BROWSE** screen will open.
3. Use the ◀◀ button to move to the top folder level.

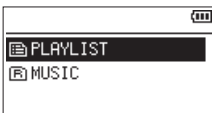

4. Use the + or – button to select **PLAYLIST**, and press the ►► button.  
This opens the **PLAYLIST** screen.



5. Use the + or – button to select the file you want to edit, and press the **QUICK** button.  
A pop-up window appears.



6. Use the + or – button to select the item you want from the following list and press ► button to execute it.  
**MOVE**  
Select this to change the order of tracks in the playlist. In addition to the file name, the track number also appears highlighted in inverse.  
• Use the + or – button to move the selected track to a different position in the playlist.

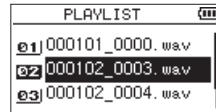

In the above example, the 4th track has been moved to the 3rd track position.

- Press the ► button.  
This completes movement and reopens the **PLAYLIST** screen.

### DELETE (Remove)

Remove the selected track from the playlist. The file is removed from the playlist, but it is not erased from the microSD card.

### ALL CLEAR

A confirmation message appears to confirm that you want to remove all the files from the playlist. Press the ►► button to clear the files. Press the ◀◀ button to cancel removal.

For this operation, it does not matter which track you select in step 3. All the files are removed from the playlist, but they are not erased from the microSD card.



## Selecting files for playback (skipping)

When the Home Screen is open, use the **I◀◀** and **▶▶I** buttons to select the file for playback.

If you press the **I◀◀** button when the playback position is located at the middle of a file, it will return to the beginning of that file. If you press the **I◀◀** button when located at the beginning of a file, the playback position will skip to the beginning of the previous file.

If you press the **▶▶I** button when located at the beginning of or middle of a file, the playback position will skip to the beginning of the next file.

### NOTE

- Files in the playback area can be played.
- The track name, file number and other file information for the currently playing file appear on the display.
- When the IN and OUT points are set between the current position and the end of the track, pressing this button skips to those points. Use the **I◀◀** and **▶▶I** buttons if you want to move between songs.

## Playing recordings

When the Home Screen is open and playback is stopped, press the **▶** button to start playback.

### NOTE

- Files in the playback area can be played.
- You can also choose files for playback by name on the BROWSE screen.

## Pausing

When the Home Screen is open and a file is playing back, press the **⏸ (HOME) [■]** button to pause playback at the current position.

Press the **▶** button again to restart playback from that position.

## Stopping

When the Home Screen is open and a file is playing back, press the **⏸ (HOME) [■]** button to pause playback. Press the **⏸ (HOME) [■]** button again to return to the beginning of the file.

## Searching backward and forward

When the Home Screen is open and a file is playing back or stopped, press and hold the **I◀◀** or **▶▶I** button to search the playback file backward or forward.

### NOTE

Press and hold the **I◀◀** or **▶▶I** button to accelerate the search speed.

## Repeat playback (REPEAT)

You can repeatedly play one file or multiple files within a designated area.

- Press the **MENU** button to open the MENU screen.
- Use the **+** or **-** button to select (highlight) the **PLAY SETTING** menu item, and press the **▶** button. This opens the **PLAY SETTING** screen.
- Use the **+** or **-** button to select (highlight) the **REPEAT** item, and press the **▶▶I** or **▶** button.

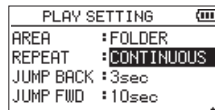

- Use the **+** or **-** button to select a repeat mode.
  - CONTINUOUS (default)**  
All files in the playback area are played in sequence one time. (This setting is the ordinary playback mode.)
  - SINGLE**  
The selected track is played once without repeating. The **▶** icon appears on the Home Screen.
  - 1 REPEAT**  
The current file is played repeatedly. The **▶** icon appears on the Home Screen.
  - ALL REPEAT**  
All files in the selected playback area are played back repeatedly. The **▶** icon appears on the Home Screen.

### NOTE

If you start loop playback, the repeat operation automatically switches to **CONTINUOUS** if it is in **SINGLE**, **1 REPEAT**, or **ALL REPEAT** mode.

- After completing the setting, press the **⏸ (HOME) [■]** button to return to the Home Screen and start playback.

### Special playback control functions

The unit has some special playback control functions. For example, you can play a selected section of a file repeatedly or change the tempo of music without changing the pitch. You can also enhance the perceived overall sound pressure for comfortable listening when the playback sound is difficult to hear.

These playback control functions enable effective practice and analysis of musical passages.

### Playback Control screen

Use the Playback Control screen to set the playback control functions.

While the Home Screen is open when stopped or playing back, press the **PB CONT** button to open the Playback Control screen.

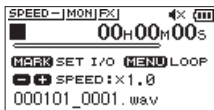

This screen can be used to make settings for the playback speed and loop playback.

After you finish making settings on this screen, press the  $\phi$ /I (**HOME**) [■] or **PB CONT** button to return to the Home Screen.

### Loop playback of a selection

With this function, you can continuously repeat (loop) the playback of a selection that you make.

1. While the Home Screen is open when stopped or playing back, press the **PB CONT** button to open the Playback Control screen.

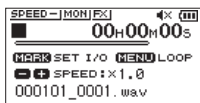

2. Press the **▶** button to start playback, and press the **MARK** button at the start point of the section that you want to play repeatedly.

This position is set as the IN (start) point.



3. Press the **MARK** button at the end point of the section that you want to play repeatedly.

This position is set as the OUT (end) point, and loop playback of the section between the IN and OUT points starts.

During loop playback the  $\phi$ I/O indicator also appears. Press the **PB CONT** button to return to the Home Screen while maintaining the IN (start) and OUT (end) point and loop settings.

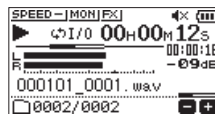

#### NOTE

- The I/O Too Short pop-up message appears if the section between the IN and OUT points is too short. Set them again. The section should be 1 second or longer.
- Press the **MARK** button again to clear the IN and OUT points.
- To stop loop playback, press the **MENU** button when the Playback Control screen is open. Press the **MENU** button again to start loop playback between the set IN and OUT points.
- You cannot set the IN and OUT points in different files.
- The previous IN and OUT point settings are lost when you set the IN point on a different file.
- Accurate assignment of IN and OUT points is not always possible for variable bit rate (VBR) MP3 files.

## Changing the playback speed (VSA)

This unit has a built-in variable speed audition (VSA) function to change the playback speed without changing its pitch.

### CAUTION

The VSA function will not work when you select a file recorded with a sampling rate of 96kHz. At this time, **SPEED X** will appear on the Home Screen. However, the playback speed can be changed.

Even though it will not affect this file, the playback speed adjustment will become effective when a 44.1/48kHz file is selected using the **I◀◀** or **▶▶I** button on the Home Screen.

When the Playback Control screen is open, press the + or – button to increase or decrease the playback speed.



The VSA function can change the playback speed in the range from 0.5 (50%) to 2.0 (200%) times (in 0.1 increments) the normal speed.

Press the **PB CONT** button to return to the Home Screen while maintaining the set playback speed.

The **SPEED▲** or **SPEED▼** icon appears if the playback speed is set to a value larger or smaller than 1.0, respectively.

## Setting the playback equalizer

You can choose from different sound equalization settings to enhance listenability (PLAY EQ).

Use the **PLAY EQ** item on the I/O SETTING screen or the Quick menu to set the playback equalization.

### Operation from the MENU screen

1. Press the **MENU** button to open the MENU screen.
2. Use the + or – button to select (highlight) **I/O SETTING** and press the **▶** button.  
The **I/O SETTING** screen will open.
3. Use the + or – button to select (highlight) the **PLAY EQ** menu item, and press the **▶** button.

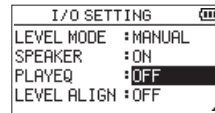

4. Use the + and – buttons to adjust the playback equalization.  
**TREBLE**, **MIDDLE**, and **BASS** indicate that adjustment in the high, middle, or low frequency range is enabled, and + and – indicate that the sound level in that range is increased or decreased, respectively.  
**Options:** OFF (default), **TREBLE +**, **TREBLE -**, **MIDDLE +**, **MIDDLE -**, **BASS +**, **BASS -**
5. After completing the setting, press the **⏏ (HOME)** [■] button to return to the Home Screen.

### Operation from the Quick menu

1. During playback when the Home Screen is open, press the **QUICK** button to open the Quick menu.



2. Use the + or – button to select (highlight) the **PLAY EQ** menu item, and press the **▶** button.  
This opens the **PLAY EQ** screen.

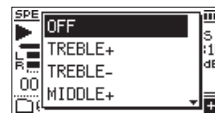

**Options:** OFF (default), **TREBLE +**, **TREBLE -**, **MIDDLE +**, **MIDDLE -**, **BASS +**, **BASS -**

3. Use the + or – button to select (highlight) a setting, and press the **▶** button to enable it and return to the Home Screen.

### Increasing the perceived overall sound pressure to enhance listenability (LEVEL ALIGN)

If the playback sound is very small and indiscernible, the perceived overall sound pressure can be increased to enhance listenability. (Level Alignment)

#### Operation from the MENU screen

1. Press the **MENU** button to open the MENU screen.
2. Use the + or – button to select (highlight) the I/O SETTING menu item, and press the ► button. The I/O SETTING screen will open.
3. Use the + or – button to select LEVEL ALIGN and press the ► button.

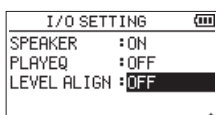

4. Use the + and – buttons to set the LEVEL ALIGN function.  
**Options:** OFF (default), ON
5. After completing the setting, press the ⏪/1 (HOME) [■] button to return to the Home Screen.

#### Operation from the Quick menu

1. During playback when the Home Screen is open, press the **QUICK** button to open the Quick menu.



2. Use the + or – button to select LEVEL ALIGN and press the ► button.
3. A screen to enable/disable the level alignment function appears.



4. Use the + or – button to select (highlight) ON, and press the ► button to enable the level alignment function. Select (highlight) OFF and press the ► button to disable the level alignment function.

#### NOTE

The level alignment function might not have much effect depending on the source of the sound (for example, a music file that has already had sound pressure adjusted).

### Using the jump function

During playback, you can jump backward or forward from the current playback position by a set amount of time.

The same playback status will be retained after jumping.

The jump forward function can only be used during dictation playback mode, overwrite recording mode and with the file division function. Operation differs in these modes.

Use the JUMP BACK and JUMP FWD settings to set the backward and forward times.

#### JUMP BACK

**Options:** OFF, 1sec, 3sec (default), 5sec, 10sec, 30sec, 1min, 5min, 10min

#### JUMP FWD

**Options:** OFF, 1sec, 3sec, 5sec, 10sec (default), 30sec, 1min, 5min, 10min

### Operation when not using dictation playback mode, overwrite recording mode or the file division function

#### Jump back

During playback, press the ► button to jump back from the current position by the set JUMP BACK time.

### Operation when using dictation playback mode, overwrite recording mode or the file division function

#### Jump back

During playback, press the ◀◀ button to jump back from the current position by the set JUMP BACK time.

#### Jump forward

During playback, press the ▶▶ button to jump forward from the current position by the set JUMP FWD time.

#### NOTE

When jumping back, if the amount of time from the current playback position to the beginning of the file is less than the set "JUMP BACK" time, playback will jump to the beginning of the file. When jumping forward, if the amount of time from the current playback position to the end of the file is less than the set "JUMP FWD" time, playback will jump to the end of the file and pause.



## Setting the jump back time

### Operation from the MENU screen

1. Press the **MENU** button to open the MENU screen.
2. Use the + or – button to select (highlight) the **PLAY SETTING** menu item, and press the ► button. This opens the **PLAY SETTING** screen.
3. Use the + or – button to select the **JUMP BACK** menu item, and press the ► button.

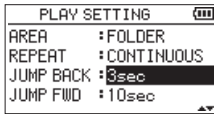

4. Use the + and – buttons to set the jump back time.
5. After completing the setting, press the **⏪/1 (HOME) [■]** button to return to the Home Screen.

#### NOTE

If the amount of time to the beginning of the file is less than the set time, playback will jump to the beginning of the file and continue playing or pause.

### Operation from the Quick menu

1. Switch the operation mode of the unit to dictation playback mode. (See “Enabling DICTATION PLAY mode” on page 45)
2. During playback when in dictation playback mode, press the **QUICK** button to open the Quick menu.



3. Use the + or – button to select the **JUMP BACK** menu item, and press the ► button. The **JUMP BACK** time setting screen will open.



4. Use the + or – button to select (highlight) a setting, and press the ► button to enable it and return to the Home Screen.

## Setting the jump forward time

### Operation from the MENU screen

1. Press the **MENU** button to open the MENU screen.
2. Use the + or – button to select (highlight) the **PLAY SETTING** menu item, and press the ► button. This opens the **PLAY SETTING** screen.
3. Use the + or – button to select the **JUMP FWD** menu item, and press the ► button.



4. Use the + and – buttons to set the jump forward time.
5. After completing the setting, press the **⏪/1 (HOME) [■]** button to return to the Home Screen.

#### NOTE

If the amount of time to the end of the file is less than the set time, playback will jump to the end of the file and pause.

### Operation from the Quick menu

1. During playback when in dictation playback mode, press the **QUICK** button to open the Quick menu.

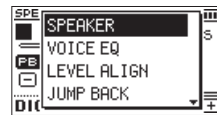

2. Use the + or – button to select the **JUMP FWD** menu item, and press the ► button. The **JUMP FWD** time setting screen will open.



3. Use the + or – button to select (highlight) a setting, and press the ► button to enable it and return to the Home Screen.

# 7 – Quick Operations

## Features of the QUICK button

The **QUICK** button can be used for the following functions.

The functions of the **QUICK** button for different screens and states are as follows.

Screen	State	Menu item	Action	Page
Home Screen	Stopped/ paused	DELETE	Delete the current file.	see page 43
		DIVIDE	Divide the current file.	see page 43
		OVERWRITE	Record over (overwrite) the current file.	see page 44
		DICTIONATION PLAY	Enable dictation playback mode.	see page 45
	During playback	SPEAKER	Turn the built-in speaker on/off.	see page 18
		PLAYEQ	Set playback equalization.	see page 39
		LEVEL ALIGN	Increase the perceived overall sound pressure to enhance listenability.	see page 40
	Recording Standby	LEVEL MODE	Set the LEVEL MODE function.	see page 24
		LOW CUT	Set the low-cut filter.	see page 21
MIC LR SWAP		Set mic left/right reversal.	see page 19	
Home Screen DICTIONATION PLAY mode	SPEAKER	Turn the built-in speaker on/off.	see page 18	
	VOICE EQ	This function enhances the vocal frequency range to make voices easier to hear in the playback sound.	see page 45	
	LEVEL ALIGN	Increase the perceived overall sound pressure to enhance listenability.	see page 40	
	JUMP BACK	Set the jump back time.	see page 41	
	JUMP FWD	Set the jump forward time.	see page 41	
	MODE EXIT	Exit DICTIONATION PLAY mode.	see page 45	
Playback Control screen	SPEAKER	Turn the built-in speaker on/off.	see page 18	
	PLAYEQ	Set playback equalization.	see page 39	
	LEVEL ALIGN	Increase the perceived overall sound pressure to enhance listenability.	see page 40	
BROWSE	When file selected	FILE INFORMATION	Show file information for the selected file.	see page 32
		ADD PLAYLIST	Add the selected file to the playlist.	
		DELETE	Delete the selected file.	
	When folder selected	SELECT	Select the first file in the selected folder.	see page 33
		ALL DELETE	Deletes all files in the selected folder.	
		FOLDER DELETE	Delete the selected folder and all files in it.	
PLAYLIST screen	MOVE	Change the order of files that have been added to the playlist.	see page 36	
	DELETE	Remove a file that has been added to the playlist.		
	ALL CLEAR	Remove all files that have been added to the playlist.		
TUNER			Switch between CALIB and INPUT LEVEL items	see page 50
OVERWRITE MODE	TO EDIT POINT	Move to where overwrite recording started.	see page 44	
	UNDO	Restore to state before most recent overwrite recording.	see page 44	
	MODE EXIT	Exit OVERWRITE mode.	see page 44	

## Quick menu

Press the **QUICK** button to open the Quick menu when you want to use it.

The content of the Quick menu differs according to the recorder status and operation mode.

Press the **QUICK** or **⏏/I (HOME) [■]** button to close the Quick menu.



Quick menu when playback is stopped or paused

## Deleting files

The currently selected file can be deleted without using the **BROWSE** screen.

- To delete a file, select it using the **⏪** or **⏩** button or the **BROWSE** screen.
- While the Home Screen is open when stopped, press the **QUICK** button to open the Quick menu.



- Use the **+** or **-** button to select **DELETE**.
- Press the **▶** button to open a confirmation screen for file deletion.



To delete the file, press the **▶▶** button. To cancel deletion, press the **⏪⏪** button.

## Dividing the selected file (DIVIDE)

A recorded file can be divided into two at a specified position.

- Select a file to be divided using the **⏪⏪** or **⏩⏩** button or the **BROWSE** screen.
- While the Home Screen is open when stopped, press the **QUICK** button to open the Quick menu.

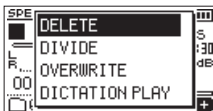

- Use the **+** or **-** button to select **DIVIDE**, and press the **▶** button.  
The **DIVIDE** screen will open.

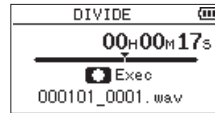

- Use the **+** or **-** button to specify the position for file division, and press the **RECORD [●]** button.  
The following pop-up window appears.



- Press the **▶▶** button to divide the file.  
If you press the **⏪⏪** button, the file will not be divided and the **DIVIDE** screen will reopen.

### NOTE

- When the **DIVIDE** screen is open, you can press the **▶** button and set the divide position while playing the track.
- When the **DIVIDE** screen is open, press the **▶** button to start/pause playback and press the **⏪⏪** / **⏩⏩** button to move to the beginning/end of the track. Adjust the position for file division using the **+** or **-** button. Press and hold the **+** or **-** button to move the position continuously.
- After dividing a file, two new files with “\_a” and “\_b” added to the end of the original file name are created.

### Examples

File name before division

000101\_0001.wav

File names after division

000101\_0001\_a.wav (part before division point)

000101\_0001\_b.wav (part after division point)

### CAUTION

- MP3 files cannot be divided.
- If the microSD card has insufficient open space, division might not be possible.
- Division is not possible if the file name would become more than 200 characters long.
- Division is not possible if the name that would be given to a new file is the same as the name of an existing file.

### TIP

Add marks during recording at positions where you want to divide a file. By opening the **DIVIDE** screen after moving to a mark, you can divide at its position. (See “Adding marks manually” on page 48)

## Overwrite recording

A recorded file can be overwritten from a desired position.

### Selecting a file to overwrite record

On the BROWSE screen, select the file to overwrite record.

#### NOTE

File skipping cannot be used to select files in overwrite recording mode.

### Activating overwrite recording mode

1. While the Home Screen is open when stopped, press the **QUICK** button to open the Quick menu.

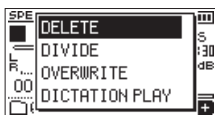

2. Use the + or – button to select the **OVERWRITE** menu item, and press the ► button. This will activate overwrite recording mode.



3. Use the ◀◀, ▶▶ and ► buttons to stop at the position where you want to start overwrite recording. At this time, using the ◀◀ or ▶▶ button will jump. (See “Using the jump function” on page 40)

## Conducting overwrite recording

1. Press the **RECORD** [●] button. The following pop-up window appears.



Press the ►▶ button to close the pop-up window and start recording standby.

2. Press the **RECORD** [●] button again to start overwrite recording.
3. Press the ◀/| (**HOME**) [■] button to stop overwrite recording. After stopping recording, the unit will return to the overwrite recording starting point and stop.

## Checking the result of recording

Play the recorded file to check it.

#### NOTE

To return to the starting point of overwrite recording, you can select **T0 EDIT POINT** from the Quick menu.

## Undoing and redoing

In overwrite recording mode, you can undo an overwrite recording once to return to the immediately previous state. You can also restore (REDO) an undone change.

#### CAUTION

- Overwrite recording does not change the file name.
- Overwrite recording can be done as many times as you like, but only the file before the most recent overwritten recording will be retained. Overwriting again will delete the earlier file.

## Ending overwrite recording mode

When the Home Screen is open and the unit is stopped, use the Quick menu to select **MODE EXIT**, and press the ► button.

This ends overwrite recording mode.

#### CAUTION

Ending overwrite recording mode will delete any file available for **UNDO** (REDO) operations.

## Transcribing recorded files (DICTATION PLAY)

The DICTATION PLAY mode allows you to search for the parts of the selected file that you want to hear during playback, making it useful for transcribing meeting minutes, for example.

In DICTATION PLAY mode, the file skip function is disabled to prevent accidentally moving to the previous or next file. Select the file before enabling DICTATION PLAY Mode.

### Enabling DICTATION PLAY mode

1. While the Home Screen is open when stopped, press the **QUICK** button to open the Quick menu.

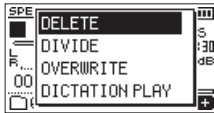

2. Use the + or – button to select (highlight) the **DICTATION PLAY** menu item, and press the ► button. This will activate DICTATION PLAY mode.

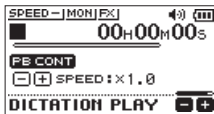

### Adjusting the playback equalization

Using the Quick menu, you can make the audio easier to hear.

**VOICE EQ:** This makes the vocal frequency range easier to hear.

**LEVEL ALIGN:** The overall sound pressure is increased to enhance listenability.

### Changing the playback position

Press ◀◀ briefly: jump back

Press ▶▶ briefly: jump forward

You can set the jump back and jump forward times from the Quick menu when stopped.

## Changing the playback volume and speed

Press the **PB CONT** to switch between changing the volume and speed of playback.



Playback speed adjustment mode

Use the + and – buttons to change the playback volume/speed.

### Exiting DICTATION PLAY mode

When the Home Screen is open and the unit is stopped, use the Quick menu to select **MODE EXIT**, and press the ► button.

This exits DICTATION PLAY mode.

#### NOTE

- Recording is not possible in DICTATION PLAY mode.
- Menu operations are not possible in DICTATION PLAY mode.
- To use a menu, exit DICTATION PLAY mode temporarily.

## 8 – Timer recording functions

Recording can be started and stopped at set times. Make date and time, recording level and other recording settings before using the timer recording functions.

### NOTE

When timer recording is enabled, the following functions are disabled.

- Auto recording
- Pre-recording
- Auto tone
- Automatic power saving

## Opening the timer recording screen

Open the **TIMER REC** screen to set the timer recording functions.

1. Press the **MENU** button to open the **MENU** screen, and select the **TIMER REC** item.

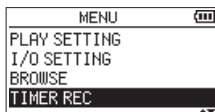

2. Press the **▶** button to open the **TIMER REC** screen.

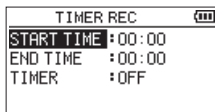

## Setting start and end times for timer recording

1. Use the + and – buttons to select **START TIME** or **END TIME**, and press the **▶▶▶** or **▶** button. An  will appear to the right of the time being set.

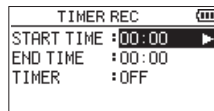

2. Press the **▶** button to open the time setting screen.



START TIME screen

3. Use the **◀◀◀** and **▶▶▶** buttons to move the cursor, and use the + and – buttons to change the hour and minute.
4. After making the setting, press the **▶** button to confirm.

### NOTE

- Always press the **▶** button to confirm the setting. Pressing the **MENU** or **⏪** (**HOME**) [] button will discard the changes.
- The time is displayed in 24-hour format.
- A setting of no time, which is shown as --:-- can be set by setting the start or end time on a time setting screen to a value higher than 23.

No START TIME set	Recording will start as soon as timer recording is executed.
No STOP TIME set	Recording will continue until the card is full or the batteries die.

## Executing timer recording

- Use the + and – button to select **TIMER** and press the ►► or ► button.

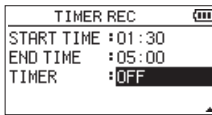

- Use the + or – button to select the function. When the setting is being changed, [ ] appears to the right of the setting option.

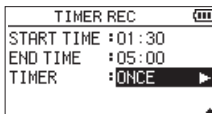

Option	Meaning
OFF	Timer recording is disabled.
ONCE	Timer recording will occur once at the specified time.
DAILY	Timer recording will occur every day at the specified time.

### NOTE

- If either the **START TIME** or **END TIME** is left unset, the options available will be **OFF** and **ONCE**.
- Timer recording is not possible if neither the **START TIME** nor the **END TIME** is set (--:-- shown).

### TIP

Generally, recording for several hours should be possible (44.1kHz/16-bit WAV) after standing by for 24 hours. When the standby time is long or the setting is **DAILY**, use a TASCAM PS-P520E AC adapter or a TASCAM BP-6AA external battery.

- Press the ► button again to open a confirmation message.



- Press the ►► button to execute timer recording.



### NOTE

If the **START TIME** has not been set, recording will start immediately.

### Recording will start at the set time.

During timer recording, **TIMER REC** appears on the screen.

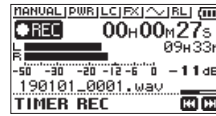

### Canceling timer recording when in standby

Press the ◻/I (**HOME**) [ ] button to open a confirmation message.



Press the ►► button to cancel timer recording and return to the Home Screen. Canceling will set timer recording to **OFF**.

### Recording will stop at the set time.

What happens after recording stops depends on the set operation mode.

Option	Meaning
ONCE	The unit will turn off after recording stops.
DAILY	The unit will enter standby mode again after recording stops.

### Canceling scheduled recordings during timer recording

Press the ◻/I (**HOME**) [ ] button to open a confirmation message.



Press the ►► button to cancel timer recording and return to the Home Screen. Canceling will set timer recording to **OFF**.

### NOTE

- If the batteries die or power is cut off when in standby, timer recording will not be executed.
- When in standby, operations other than the pressing the ◻/I (**HOME**) [ ] are disabled.
- If the **HOLD** switch is set in the direction of the arrow, disable the hold function before operating.
- The **START TIME** or **END TIME** settings are retained after timer recording completes. The **START TIME** or **END TIME** settings are also retained when timer recording is canceled.

## 9 – Mark functions

### Adding marks manually

When playing, recording or in recording standby, press the **MARK** button to add a mark at any point.

When a mark is added, a pull-up appears at the bottom of the display.

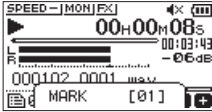

#### NOTE

- Mark information is stored in the file with numbers between 01–99. The maximum number of marks in a file is 99.
- Since the unit is compatible with BWF format WAV files, marks added to a WAV file during recording are stored in it. Marks stored in the file are available when playing back the file using BWF-compatible software, for example.

### Adding marks automatically to a recording

This function allows the unit to add marks automatically using AUTO REC.

On the REC SETTING screen, set the AUTO REC MODE to MARK.

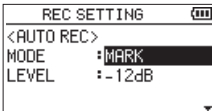

For details, see “Recording automatically (AUTO REC)” on page 27.

### Moving to mark positions

When stopped, paused or playing back, press the **I◀◀** or **▶▶I** button while pressing the **MARK** button to move (skip) to the previous or next mark in the selected file.

You can use this function to go to the beginning of a song, similar to an index.

#### NOTE

You cannot move to a cue mark of a different file.

### Clearing marks

When stopped or paused, move to a mark. Then, press the **MARK** button to clear that mark.



This unit has built-in effects.

Effects can be applied to the input signal during recording and practice as well as to the signal during playback.

When an effect is on, the **FX** icon appears as light letters on a dark background (**FX**) at the top of the Home Screen.

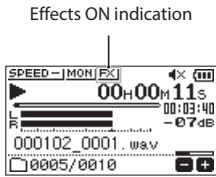

4. Use the + or – button to select the desired item and press the **▶▶** button or **▶** button to access that item's settings.
5. Use the + or – button to set the desired value.
6. Press the **◀◀** button when you are done making the setting to return to item selection status.
7. After completing the setting, press the **⏪** (**HOME**) [**■**] button to return to the Home Screen.

### CAUTION

When the sampling frequency is set to 96 kHz, or a WAV file with a sampling frequency of 96 kHz is played, the built-in effects do not work. However, you can still set the built-in effects.

## Setting the effect

1. Press the **MENU** button to open the **MENU** screen.
2. Use the + and – buttons to select (highlight) the **OTHERS** menu item, and press the **▶** button to open the **OTHERS** screen.
3. Use the + or – button to select **EFFECT**, and press the **▶** button.

The **EFFECT** screen will open.

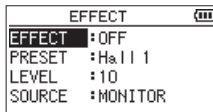

As shown in the above illustration, there are four setting items on the **EFFECT** screen.

Set each item using the **◀◀**, **▶▶**, + and – buttons.

#### EFFECT

Use this to turn the effect on or off.

(Default: **OFF**)

#### PRESET

Select the preset for the effect being used. See the "Effects Preset List" on page 49 for details about the preset effects.

#### LEVEL

Use this to change the output level of the preset effect selected in the **PRESET** item. Setting range: 0 – 20 (Default: 10)

#### SOURCE

Use this to set whether the effect is applied to the input signal (**INPUT**) or the output signal (**MONITOR**). (Default: **MONITOR**)

## Effects Preset List

Preset name	Effects
Hall 1 (default)	This is a bright reverb modeled after a large hall-like space.
Hall 2	This is a warm reverb modeled after a large hall-like space.
Room	This reverb is modeled on a small indoor space.
Studio	This reverb is modeled on a studio-like space.
Plate 1	This is a bright plate reverb.
Plate 2	This is a warm plate reverb.

# 11 – Tuning an instrument

This unit has a built-in tuner. By inputting sound from a musical instrument, you can tune it accurately while viewing the tuning meter shown in the display.

## Using the tuner

### Setting the tuner

1. Press the **MENU** button to open the **MENU** screen.
2. Use the + and – buttons to select (highlight) the **OTHERS** menu item, and press the **▶** button to open the **OTHERS** menu.
3. Use the + or – button to select **TUNER**, and press the **▶** button.

The **TUNER** screen will open.

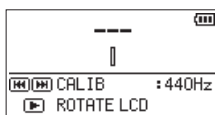

The **TUNER** screen contains a **CALIB** option to set the frequency of A. Press the **◀◀** or **▶▶** button to decrease or increase the fundamental frequency.

**Setting range:** 435Hz - 445Hz

(in 1 Hz increments, default: 440Hz)

#### NOTE

When the **TUNER** screen is open, press the **▶** button to reverse the screen orientation.

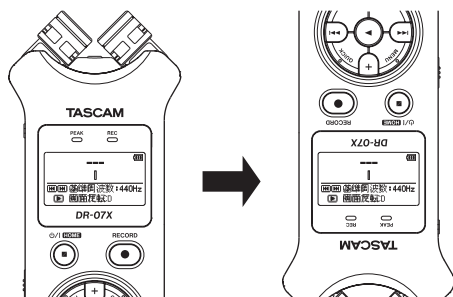

## Tuning a musical instrument

1. Open the **TUNER** screen, and sound a note near the unit. The closest pitch name will be shown above the center of the meter.
2. Tune the instrument so that the target pitch name appears and the center of the tuner lights. A bar appears to the left or right of center if the sound is lower or higher than the target pitch. The bar becomes longer the more the input pitch differs from the target pitch.

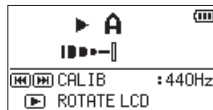

## Adjusting the input level for tuning

1. Press the **QUICK** button to switch **CALIB** to **INPUT LEVEL** in the bottom of the **TUNER** screen.
2. Use the **◀◀** or **▶▶** button to adjust the input level. During adjustment, a pull-up with meters showing the input level will appear at the bottom of the display. Adjustment is the same as explained in "Adjusting the input level" on page 26.

By connecting this unit with a computer using a USB cable, you can power the unit with USB bus power, and use the unit as an SD card reader and as a USB audio interface.

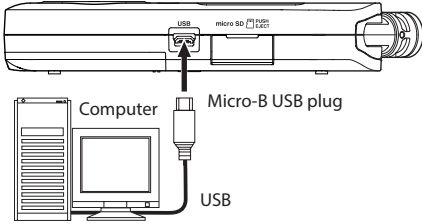

### CAUTION

The unit should be connected directly with the computer instead of via a USB hub.

## Powering the unit with USB bus power

### When the unit is off

1. Connect the computer and the unit with a USB cable, and turn the unit on to open the USB screen.

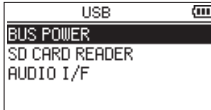

2. Use the + or – button to select **BUS POWER** and press the ► button to select power from the **USB** port and reopen the Home Screen.

### When the unit is on

When operating on batteries, if you connect the computer and the unit with a USB cable, the unit will be powered from its **USB** port (USB bus power is used first).

### NOTE

The same thing will also happen when using an AC adapter.

## Using as an SD card reader

By connecting this unit with a computer using a USB cable, you can use it as an SD card reader.

You can transfer recorded audio files to a computer and also transfer audio files from a computer to the unit.

### When the unit is off

1. Connect the computer and the unit with a USB cable, and turn the unit on to open the USB screen.

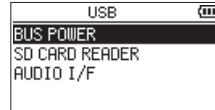

2. Use the + or – button to select **SD CARD READER** and press the ► button.

The **SD CARD READER** screen will open.



### When the unit is on

When operating on batteries, connect the unit and the computer with a USB cable

1. Press the **MENU** button to open the MENU screen.
2. Use the + or – button to select **USB**, and press the ► button to open the USB screen.

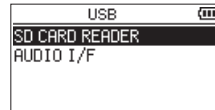

3. Use the + or – button to select (highlight) the **SD CARD READER** item and press the ► button.

The **SD CARD READER** screen will open.



### Disconnecting the unit from a computer

Before disconnecting the computer and the unit, use the proper procedures for the computer to unmount the unit, and press the ◀◀ button.

Disconnect from the computer and return to the Home Screen.

### Transferring files from a computer

1. Click the “DR-07X” drive on the computer screen to show the “MUSIC” and “UTILITY” folders.
2. Drag and drop files on the computer that you want to transfer to the unit to the “MUSIC” folder.

#### TIP

- You can manage the “MUSIC” folder from the computer.
- You can create subfolders in the “MUSIC” folder up to the second level for use with this unit. Only two levels of folders can be created. This unit cannot recognize subfolders and audio files on the third level or below.
- Since you can set the DR-07X to only play the contents of a specific folder, you can organize files into genres, artists or other categories as you like.
- If you name the subfolders and music files, these names will appear on the screen of this unit.

### Using as a USB audio interface

By connecting this unit with a computer using a USB cable, you can use it as a USB audio interface.

### Opening the AUDIO I/F screen

#### When the unit is off

1. Connect the computer and the unit with a USB cable, and turn the unit on to open the USB screen.

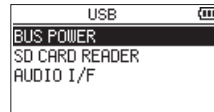

2. Use the + or – button to select (highlight) AUDIO I/F, and press the ► button.

The AUDIO I/F screen will open.

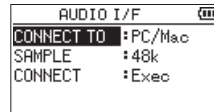

#### When the unit is on

When operating on batteries, connect the unit and the computer with a USB cable.

1. Press the **MENU** button to open the MENU screen.
2. Use the + or – button to select USB, and press the ► button to open the USB screen.

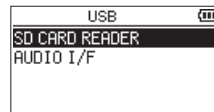

3. Use the + or – button to select (highlight) the AUDIO I/F item and press the ► button.

The AUDIO I/F screen will open.

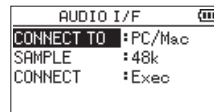

## Setting the connected device type

1. When the **AUDIO I/F** screen is open, use the + or – button to select (highlight) the **CONNECT TO** menu item, and press the ► button.

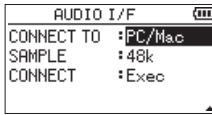

2. Use the + and – buttons to set the type of connected device.

**Options:** PC/Mac (default), iOS

### NOTE

- With Windows, an ASIO driver for the DR-X series can be used. Check the page for this product on the TASCAM website (<https://tascam.com/us/>) for details.
- With a Mac, the standard OS driver will be used, so there is no need to install any software.
- If the connected device type is iOS, this unit will operate on batteries.
- Lightning to USB Camera Adapter, for example, is necessary to connect to an iOS device.

## Connecting

1. When the **AUDIO I/F** screen is open, use the + or – button to select (highlight) the **CONNECT** menu item, and press the ► button.

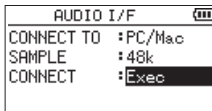

2. Press the ► button to enable audio interface mode and return to the Home Screen.

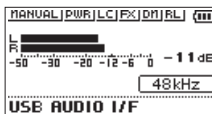

### NOTE

When in audio interface mode, press the **MENU** button to access the following functions.

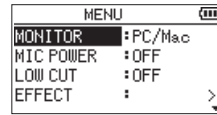

- **MONITOR:** Set to **DIRECT** to mix the mic input and computer output sounds, enabling input monitoring without lag.
- **MIC POWER:** When connecting a microphone that requires plug-in power, set this to **ON**.
- **LOW CUT:** Set the cutoff frequency of the low-cut filter during input.
- **EFFECT:** Open the effect settings screen.
- **DISCONNECT:** End the USB audio interface mode connection.

# 13 – Settings and Information

## Viewing information (INFORMATION)

Use the **INFORMATION** screen to view various types of information about this unit.

Follow the steps below to display the **INFORMATION** screen.

1. Press the **MENU** button to open the **MENU** screen.
2. Use the + and – buttons to select (highlight) the **OTHERS** menu item, and press the ► button to open the **OTHERS** screen.
3. Use the + or – button to select **INFORMATION**, and press the ► button.

The **INFORMATION** screen contains the following three pages. Use the + or – button to move through the pages.

- **File information page (FILE)**  
Shows information about the currently loaded file.
- **Card information page (CARD)**  
Shows the use status of the currently inserted microSD card
- **System information page (SYSTEM)**  
Shows the unit's system setting information and firmware version.

## File information page (FILE)

The **FILE** page shows information about the currently selected file.

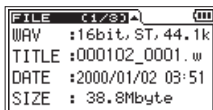

FILE	C1/S1	⏏
WAV	:16bit, ST, 44.1k	
TITLE	:000102_0001.w	
DATE	:2000/01/02 03:51	
SIZE	: 38.8Mbyte	

### WAV/MP3

This shows the audio file format.

For WAV files, bit length, stereo/mono, and sampling frequency (Hz) also appear.

For MP3 files, the bit rate (kbps), CBR (constant bit rate) or VBR (variable bit rate) type, and sampling frequency (Hz) also appear.

### TITLE

Shows the file name.

If an MP3 file has ID3 tag title information that information appears.

### DATE

Date of file creation

### SIZE

File size

## Card information page

The **CARD** page shows the status of the currently inserted microSD card.

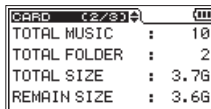

CARD	C2/S3	⏏
TOTAL MUSIC	: 10	
TOTAL FOLDER	: 2	
TOTAL SIZE	: 3.7G	
REMAIN SIZE	: 3.6G	

### TOTAL MUSIC

Shows the number of playable files in the **MUSIC** Folder.

### TOTAL FOLDER

Shows the total number of folders in the **MUSIC** folder.

### TOTAL SIZE

Shows the total microSD card capacity.

### REMAIN SIZE /USED SIZE

Shows the amount of unused/used capacity on the microSD card.

Press the ◀◀ or ▶▶ button to switch between **REMAIN SIZE** and **USED SIZE**.

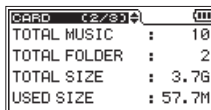

CARD	C2/S3	⏏
TOTAL MUSIC	: 10	
TOTAL FOLDER	: 2	
TOTAL SIZE	: 3.7G	
USED SIZE	: 57.7M	

## System information page

The **SYSTEM** page shows information about the unit's system settings and firmware version.

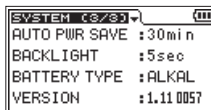

SYSTEM	C3/S3	⏏
AUTO PWR SAVE	:30min	
BACKLIGHT	:5sec	
BATTERY TYPE	:ALKAL	
VERSION	:1.11 0057	

### AUTO PWR SAVE

Shows the automatic power OFF setting.

### BACKLIGHT

Shows the automatic backlight OFF setting.

### BATTERY TYPE

Shows the battery type setting.

### VERSION

Shows the system firmware version.

## System Settings

From the **SYSTEM** screen, you can change various settings to optimize the device for your use environment and other requirements.

Follow the steps below to display the **SYSTEM** screen.

1. Press the **MENU** button to open the **MENU** screen.
2. Use the + or – button to select (highlight) the **SYSTEM** menu item, and press the ► button. This opens the **SYSTEM** screen.

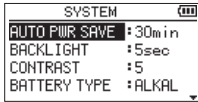

The following settings can be made for the items on the **SYSTEM** screen.

Use the ◀◀ or ▶▶ button and the + or – button to set each item.

### Setting the automatic power saving function

You can use the **AUTO PWR SAVE** item to set the amount of time from when the unit last operated or was used until the power turns off (enters standby) automatically.

**Options:** OFF (does not turn off automatically), 3min, 5min, 10min, 30min (default)

### Setting the backlight

Use the **BACKLIGHT** item to set the time after the last operation until the backlight automatically turns off.

**Options:** OFF (backlight off), 5sec (default), 10sec, 15sec, 30sec, ALWAYS (always on)

### Adjusting the display contrast

Use **CONTRAST** to adjust the display contrast.

**Options:** 1–20 (default: 5)

### Setting the battery type

Use the **BATTERY TYPE** item to set the battery type. This setting is used to display the remaining battery power and to calculate the minimum capacity for normal operation.

**Options:** ALKAL (alkaline batteries, default), Ni-MH (nickel-metal hydride batteries)

## Set the language

Use the **LANGUAGE** item to set the language shown on the display.

1. Use the + or – button to select (highlight) the **LANGUAGE** item and press the ► button.

#### Options:

ENG: use English  
 日本語: use Japanese  
 FRA: use French  
 ESP: use Spanish  
 DEU: use German  
 ITA: use Italian  
 POR: use Portuguese  
 RUS: use Russian  
 中文: use Chinese  
 한글: use Korean

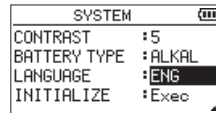

2. Press the ► button to open a pop-up confirmation window.



3. Press the ▶▶ button to confirm the language selection. To cancel language selection, press the ◀◀ button.

### Setting the language if the wrong was set

After pressing the ◀/I (**HOME**) [■] button to turn the unit off, press the ◀/I (**HOME**) [■] button while pressing and holding the **MENU** button. The language selection menu will appear, and you will be able to select the language.

## Restoring the factory settings

Use the **INITIALIZE** item to restore the various settings of this unit to their factory settings.

1. Use the + or – button to select **INITIALIZE**, and press the ► button to highlight **Exec.**
2. Press the ► button to open a pop-up confirmation window.



3. Press the ►► button to initialize the unit. Press ◀◀ button to cancel initialization.

## Formatting microSD cards

Use the **QUICK FORMAT** item to format a microSD card. Formatting a microSD card erases all music files on the card and automatically creates new "MUSIC" and "UTILITY" folders as well as a "dr-1.sys" file.

1. Use the + or – button to select **QUICK FORMAT**, and press the ► button to highlight **Exec.**
2. Press the ► button to open a pop-up confirmation window.



3. Press the ►► button to start formatting the microSD card. Press the ◀◀ button to cancel formatting the microSD card.

## Completely formatting SD cards

Use the **FULL FORMAT** item to completely format a microSD card.

Full formatting checks the memory for errors while formatting, so it takes more time than quick formatting.

Full formatting a microSD card erases all music files on the card and automatically creates new "MUSIC" and "UTILITY" folders as well as a "dr-1.sys" file.

1. Use the + or – button to select **FULL FORMAT**, and press the ► button to highlight **Exec.**
2. Press the ► button to open a pop-up confirmation window.



3. Press the ►► button to start full formatting of the microSD card. Press the ◀◀ button to cancel full formatting of the microSD card.

### CAUTION

When formatting a microSD card, the unit should be operating on power supplied by a PS-P520E adapter (sold separately), computer USB bus power or batteries with sufficient remaining power.

If the power fails during formatting, the formatting may not occur correctly.

### NOTE

- Using the **FULL FORMAT** option might restore an SD card that has decreased writing performance due to repeated use.
- **FULL FORMAT** checks the memory for errors while formatting, so it takes more time than **QUICK FORMAT**.



## Setting the file name format

You can select the format of names given to files recorded by this unit.

1. Press the **MENU** button to open the **MENU** screen.
2. Use the + and – buttons to select (highlight) the **OTHERS** menu item, and press the **▶** button to open the **OTHERS** screen.
3. Use the + or – button to select **FILE NAME**, and press the **▶** button.

The **FILE NAME** screen will open.



Set each item using the **◀◀**, **▶▶**, + and – buttons. On this screen you can make the following settings for each item.

### File name format

The **TYPE** item can be set to either **WORD** or **DATE**.

**Options:** **WORD**, **DATE** (default)

**WORD:** The six characters set in **WORD** will be included in file name.

Example: DR0000\_0000.wav

**DATE:** The date is used as the file name (in yymmdd format).

Example: 110101\_0000.wav

#### NOTE

The date is set using the unit's internal clock. (See "Setting the date and time" on page 16)

### Setting the WORD item

To set the **WORD** item, use the **◀◀** and **▶▶** buttons to move the cursor, and use the + or – button to select the character.

In addition to the alphabet and numbers, the following characters can be used.

! # \$ % & ' ( ) + , - . ; = @ [ ] ^ \_ ` { } ~

# 14 – Messages

The following is a list of pop-up messages.

Refer to this list if one of these pop-up messages appears on the DR-07X and you want to check the meaning or determine a proper response.

Message	Details and responses
File Name Err	The DIVIDE function would cause the file name to exceed 197 characters. Before choosing the DIVIDE function, connect the unit to a computer and edit the file name to less than 196 characters.
Dup File Name	The DIVIDE function would cause the file name to be the same as that of an existing file in the same folder. The DIVIDE function adds "_a" or "_b" to the end of the file name. Before choosing the DIVIDE function, connect the unit to a computer and edit the file name.
File Not Found	The file added to the playlist cannot be found or a file could be damaged. Please check that file.
Non-Supported	The audio file is not a supported format. Please see "Recording/playback format" on page 61 for file formats that this unit can use.
Battery Empty	The batteries are almost out of power. Replace the batteries.
I/O Too Short	The IN and OUT points are too close together. Set them with at least 1 second between them.
File Not Found PLAYLIST	A file in the Playlist cannot be found. Please confirm that the file is still in the Music folder.
No PLAYLIST	No files have been added to the Playlist. Add a file to the Playlist or change the play mode to something besides PLAYLIST.
PLAYLIST FULL	The playlist is full. You cannot add more than 99 tracks to the Playlist.
MBR ERROR Init CARD	The card is not formatted properly or the formatting is broken. Change the card or press the ► button while this message is being shown to FAT format the card. CAUTION: Execution of FAT formatting erases all data currently on the card.
Format Error Format Card Are you sure?	The FAT formatting of the card is abnormal or broken. This message also appears if you FAT formatted the card using a computer connected by USB and if a new card is inserted in the unit. Always use the DR-07X to conduct formatting. Change the card, or press the ► button while this message is being shown to FAT format the card. CAUTION: Execution of FAT formatting erases all data currently on the card.
File Not Found Make Sys File	The system file is missing. When this message appears, press the ► button to automatically create a system file.
Invalid SysFile Make Sys File	The system file required to operate this unit is invalid. When this message appears, press the ► button to automatically create a new system file.
Invalid card Change Card	Something might be wrong with the card. Change the card.
Write error REC continue	Writing to the SD card was not in time. This has caused audio to be interrupted and noise to occur. A mark is added at the point when audio was interrupted.
Card slow Check BOF mark	SD card writing performance has become worse. A mark has been added at the point when audio was interrupted because writing to the SD card timed out. Check the audio around the mark. Execute the full format function or change the SD card.
Card Full	The card has no remaining capacity. Erase unnecessary files or move them to your computer to make open space.
Can't Divide	The selected division point is not suitable. (It is too close to the beginning or end of the track.)
Max File Size	The file is larger than the designated size, or the recording time has exceeded 24 hours when the total number of folders and files was already at the limit (5000).
File Full	The total number of folders and files exceeds 5000. Delete unnecessary folders and files or move them to a computer.
Card Error	The card could not be recognized properly. Change the card.

Message	Details and responses
Current File MP3	MP3 files cannot be divided.
File Protected	The file is read only and cannot be erased.
No Card	No microSD card is in the unit.
No PB File	There is no file that can be played back. The file might be damaged.
No MUSIC File	There is no playback file, so dividing or overdubbing cannot be executed.
Cannot overdub! See REC setting	You cannot make an mp3 file when overdubbing a WAV file with a sampling frequency of 96kHz. Change the recording format to WAV.
Not Continued	<p>If any of these errors occurs, turn the unit's power off and restart it.</p> <p>If the power cannot be turned off, remove the batteries, disconnect the AC adapter (TASCAM PS-P520E), and/or disconnect the USB cable if using USB bus power.</p> <p>If these error messages continue to appear frequently, please contact the store where you purchased this unit or TASCAM customer support service.</p>
File Error	
Can't Save Data	
Player Error	
Device Error	
Writing Failed	
Sys Rom Err	
System Err 50	
System Err 1	
System Err 2	
System Err 3	
System Err 4	
System Err 5	
System Err 6	
System Err 7	
System Err 8	
System Err 9	

# 15 – Troubleshooting

If you are having trouble with the operation of this unit, please try the following before seeking repair. If these measures do not resolve the issue, please contact the retailer where you purchased this unit or a TASCAM customer support service.

## The unit does not turn on.

- Confirm that batteries are installed correctly.
- Confirm that the **HOLD** switch is not set.

## The unit turns off automatically.

- Check the automatic power saving function setting. Set it to "Off" to prevent the power from turning off automatically. (See "Setting the automatic power saving function" on page 55)

## The microSD card is not recognized.

- Check that the microSD card is inserted correctly.

## No sound is output or sound is not output from the speaker.

- Confirm that the output volume is not lowered too much.
- Confirm that the speaker setting is on. Even if the speaker is on, sound will not be output from the speaker in the following cases.
  - Headphones are connected
  - When recording or in recording standby
  - When in overdubbing mode (See "Enabling overdubbing mode" on page 26)

## Recording is not possible.

- Confirm that the **REC** indicator is lit. If the **REC** indicator is blinking, the unit is in recording standby.
- Check the remaining available recording time shown on the Recording Screen.

## The recorded sound is quiet or distorted.

- Check the input level setting.

## The unit is not recognized by a computer connected using a USB cable.

- Confirm that the connected computer uses a compatible operating system.
- The USB function used must be selected from the menu to enable a computer to recognize this unit.
- Confirm that the USB cable is not designed only for charging.
- Confirm that the connection is not being made through a USB hub.

## Sound skips or noise occurs when in USB audio interface mode.

For Windows

- Performance options  
Select "Adjust for best performance".
- Power options  
Select "High performance".
- Use an ASIO driver for the DR-X series.  
Check the page for this product on the TASCAM website (<https://tascam.com/us/>) for details.

## The wrong language was set accidentally.

- After pressing the  $\odot/1$  (**HOME**) [■] button to turn the unit off, press the  $\odot/1$  (**HOME**) [■] button while pressing and holding the **MENU** button.  
The language selection menu will appear, and you will be able to select the language.

---

## General

---

### Recording media

- microSD card (64 MB - 2 GB)
- microSDHC card (4 GB - 32 GB)
- microSDXC card (48 GB - 128 GB)

### Recording/playback format

- WAV: 44.1/48/96 kHz, 16/24-bit
- MP3: 44.1/48 kHz, 32/64/96/128/192/256/320 kbps

### Number of channels

- 2 channels (stereo)

---

## Input/output ratings

---

### Analog audio input/output ratings

#### MIC/EXT IN jack (can provide plug-in power)

- Connector: 1/8" (3.5mm) stereo mini jack
- Input impedance: 18 k $\Omega$  or higher (PLUG IN PWR = OFF)  
2 k $\Omega$  or higher (PLUG IN PWR = ON)
- Nominal input level: -20 dBV
- Maximum input level: -4 dBV

#### $\Omega$ /LINE OUT jack

- Connector: 1/8" (3.5mm) stereo mini jack
- Output impedance: 12  $\Omega$
- Nominal output level: -14 dBV (with 10 k $\Omega$  load)
- Maximum output level: +2 dBV (with 10 k $\Omega$  load)
- Maximum output: 20 mW + 20mW (32 $\Omega$  load)

### Built-in speaker

- 0.3 W (mono)

---

## Control input/output ratings

---

### USB port

- Connector type: Micro-B
- Format
  - USB 2.0 HIGH SPEED mass storage class
  - USB1.1 FULL SPEED audio class

---

## Audio performance

---

### Frequency response

- 20 Hz - 20 kHz +0/-1 dB  
(EXT IN to LINE OUT, 44.1 kHz sampling frequency, JEITA)
- 20 Hz -22 kHz +0/-1 dB  
(EXT IN to LINE OUT, 48 kHz sampling frequency, JEITA)
- 20 Hz - 40 kHz +0/-1.5 dB  
(EXT IN to LINE OUT, 96 kHz sampling frequency, JEITA)

### Distortion

- 0.01% or less (EXT IN to LINE OUT, 44.1/48/96 kHz sampling frequency, JEITA)

### S/N ratio

- 94 dB or higher (EXT IN to LINE OUT, 44.1/48/96 kHz sampling frequency, JEITA)

Note: based on JEITA CP-2150

---

## Other specifications

---

### Power

- 2 AA batteries (alkaline or NiMH)
- USB bus power from a computer
- AC adapter (TASCAM PS-P520E, sold separately)

### Power consumption

- 1.7 W (maximum)

## Battery operation time (continuous operation)

### • Using alkaline batteries (EVOLTA)

Recording/ playback	Recording format	Operation time	Note
Recording	WAV 96kHz, 24-bit	About 15.5 hours	With built-in stereo mic input
Recording	WAV 44.1kHz, 16-bit	About 17.5 hours	With built-in stereo mic input
Recording	MP3 44.1kHz, 128Kbps	About 16.5 hours	With built-in stereo mic input
Recording	MP3 48kHz, 320Kbps	About 11 hours	With built-in stereo mic input
Playback	WAV 96kHz, 24-bit	About 14 hours	Using headphones
Playback	WAV 96kHz, 24-bit	About 14 hours	Using built-in speaker
Playback	WAV 44.1kHz, 16-bit	About 16.5 hours	Using headphones
Playback	WAV 44.1kHz, 16-bit	About 16.5 hours	Using built-in speaker
Playback	MP3 44.1kHz, 128Kbps	About 16.5 hours	Using headphones
Playback	MP3 44.1kHz, 128Kbps	About 16.5 hours	Using built-in speaker
Playback	MP3 48kHz, 320Kbps	About 15.5 hours	Using headphones
Playback	MP3 48kHz, 320Kbps	About 15.5 hours	Using built-in speaker

Recording: JEITA recording time

Playback: JEITA music playback time

### • Using NiMH batteries (eneloop)

Recording/ playback	File format (recording setting)	Operation time	Note
Recording	WAV 96kHz, 24-bit	About 12.5 hours	With built-in stereo mic input
Recording	WAV 44.1kHz, 16-bit	About 14.5 hours	With built-in stereo mic input
Recording	MP3 44.1kHz, 128Kbps	About 13 hours	With built-in stereo mic input
Recording	MP3 48kHz, 320Kbps	About 10 hours	With built-in stereo mic input
Playback	WAV 96kHz, 24-bit	About 13 hours	Using headphones
Playback	WAV 96kHz, 24-bit	About 12 hours	Using built-in speaker
Playback	WAV 44.1kHz, 16-bit	About 14 hours	Using headphones
Playback	WAV 44.1kHz, 16-bit	About 15 hours	Using built-in speaker
Playback	MP3 44.1kHz, 128Kbps	About 13.5 hours	Using headphones
Playback	MP3 44.1kHz, 128Kbps	About 13 hours	Using built-in speaker
Playback	MP3 48kHz, 320Kbps	About 13.5 hours	Using headphones
Playback	MP3 48kHz, 320Kbps	About 13 hours	Using built-in speaker

Recording: JEITA recording time

Playback: JEITA music playback time

#### NOTE

The battery operation times (during continuous operation) could vary depending on the media being used.

**Dimensions (W × H × D)**

68 × 158 × 26 mm (2.67" × 6.22" × 1.02") (when the microphone pair is closed)

90 × 158 × 26 mm (3.54" × 6.22" × 1.02") (when the microphone pair is open)

**Weight**

130 g (4.59 oz) (not including batteries)

171 g (6.03 oz) (including batteries)

**Operating temperature**

0°C–40°C (32°F–104°F)

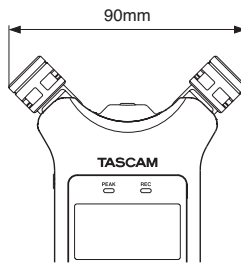
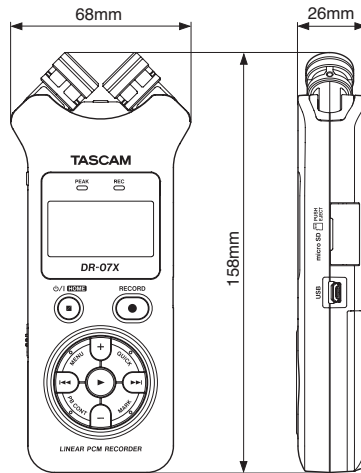
**Dimensional drawings**

Opened mic dimension

- Illustrations in this manual might differ in part from the actual product.
- Specifications and external appearance might be changed without notification to improve the product.

# TASCAM

## TEAC CORPORATION

Phone: +81-42-356-9143  
1-47 Ochiai, Tama-shi, Tokyo 206-8530 Japan

---

<https://tascam.jp/jp/>

## TEAC AMERICA, INC.

Phone: +1-323-726-0303  
10410 Pioneer Blvd. Suite #1 Santa Fe Springs, California 90670, U.S.A.

---

<https://tascam.com/us/>

## TEAC UK Ltd.

Phone: +44-1923-797205  
Meridien House, Ground Floor, 69 - 71, Clarendon Road, Watford, Hertfordshire, WD17 1DS, United Kingdom

---

<https://www.tascam.eu/en/>

## TEAC EUROPE GmbH

Phone: +49-611-71580  
Bahnstrasse 12, 65205 Wiesbaden-Erbenheim, Germany

---

<https://www.tascam.eu/de/>

## TEAC SALES & TRADING(SHENZHEN) CO., LTD

Phone: +86-755-88311561~2  
Room 817, Xinian Center A, Tairan Nine Road West, Shennan Road, Futian District, Shenzhen, Guangdong Province 518040, China

---

<https://tascam.cn/cn/>