

Install Speakers

ATHENS

TCS122/64

Arrayable 2 Way
12" Full Range Loudspeaker with
Dendritic Waveguide for
Installation Applications,
60° H x 40° V Dispersion

- Arrayable 2 way full range loudspeaker for installation applications
- Rotatable Dendritic waveguide with 60° H x 40° V dispersion
- 600 Watts continuous, 2,400 Watts peak power
- Glass fibre loaded 12" low frequency driver with aluminium voice coil for improved transient response
- Titanium dome 1.4" neodymium motor compression driver
- Multiple array configurations for extended coverage
- Switchable passive/bi-amp operation for flexibility of use
- Trapezoidal cabinet shape enables visually unobtrusive loudspeaker arrays
- Multiple internal rigging points allow bracket mount and suspension in any orientation
- 15 mm (5/8") birch plywood enclosure with hard wearing semi matt black paint finish
- Architecturally styled powder coated perforated steel mesh grille
- Neutrik speakON* NL4 and barrier strip connectors
- 3-Year Warranty Program**
- Designed and engineered in England



The 2 way full range TCS122/64 is a switchable passive/bi-amp 12" 2,400 Watt arrayable loudspeaker system that is ideally suited for a wide range of speech and music sound reinforcement applications. The TCS122/64 is designed to work in conjunction with **TURBOSOUND** loudspeaker management systems, providing optimal FOH performance, as well as offering considerable flexibility to readily adapt to varying venue requirements.



The TCS122/64 arrayable loudspeaker features a glass fibre loaded 12" low frequency driver with inside/outside wound coil with low mass voice coil for improved transient response, and a titanium dome 1.4" neodymium motor compression driver mounted on a 60° horizontal by 40° vertical Dendritic waveguide. All drivers are matched with an internal passive crossover network in a reflex-loaded enclosure, and bi-amp mode can be enabled by means of a rear panel switch. The rear panel connector plate carries Neutrik speakON* NL4 and barrier strip connectors for input and link connections to additional enclosures.

*All third-party trademarks are the property of their respective owners. Their use neither constitutes a claim of the trademark nor affiliation of the trademark owners with MUSIC Group. Product names are mentioned solely as a reference for compatibility, effects and/or components.

**Warranty details can be found at music-group.com.

Install Speakers

ATHENS

TCS122/64

Arrayable 2 Way
12" Full Range Loudspeaker with
Dendritic Waveguide for
Installation Applications,
60° H x 40° V Dispersion

TURBOSOUND's proprietary HF Dendritic waveguide features multiple hornlets with identical path lengths, which are designed to provide a flat constant-phase wavefront with a 60° horizontal by 40° vertical dispersion pattern. When the waveguide is rotated 90° from the standard position, a 40° horizontal by 60° vertical dispersion is achieved, making the TCS122/64 ideal for an even broader range of applications.

Finished in a highly durable semi matt black paint, the cabinet is constructed from 15 mm (5/8") birch plywood – and includes a rugged powder coated perforated steel mesh grille backed with reticulated foam. Internal M10 threaded rigging points are provided for suspension in any orientation, or mounting with dedicated brackets – available separately. A dedicated range of fly plates and coupler kits are also available separately for constructing tightly packed custom full-range and subwoofer enclosure arrays for aesthetically pleasing and venue specific coverage requirements.

Install Speakers

ATHENS TCS122/64

Arrayable 2 Way
12" Full Range Loudspeaker with
Dendritic Waveguide for
Installation Applications,
60° H x 40° V Dispersion

Frequency Response Sensitivity 1 W / 1 m

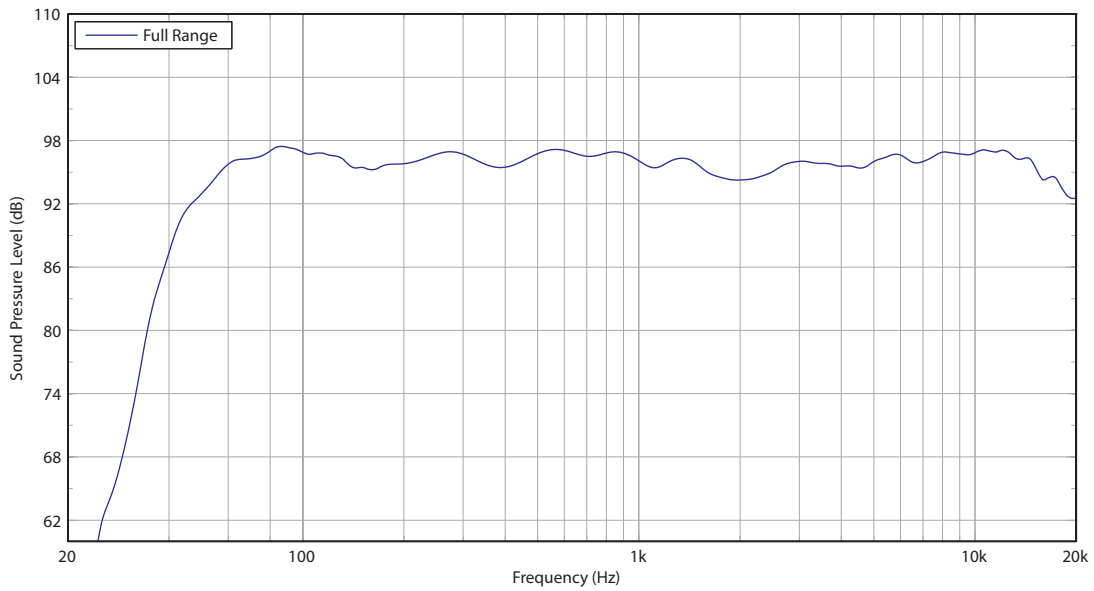

Impedance

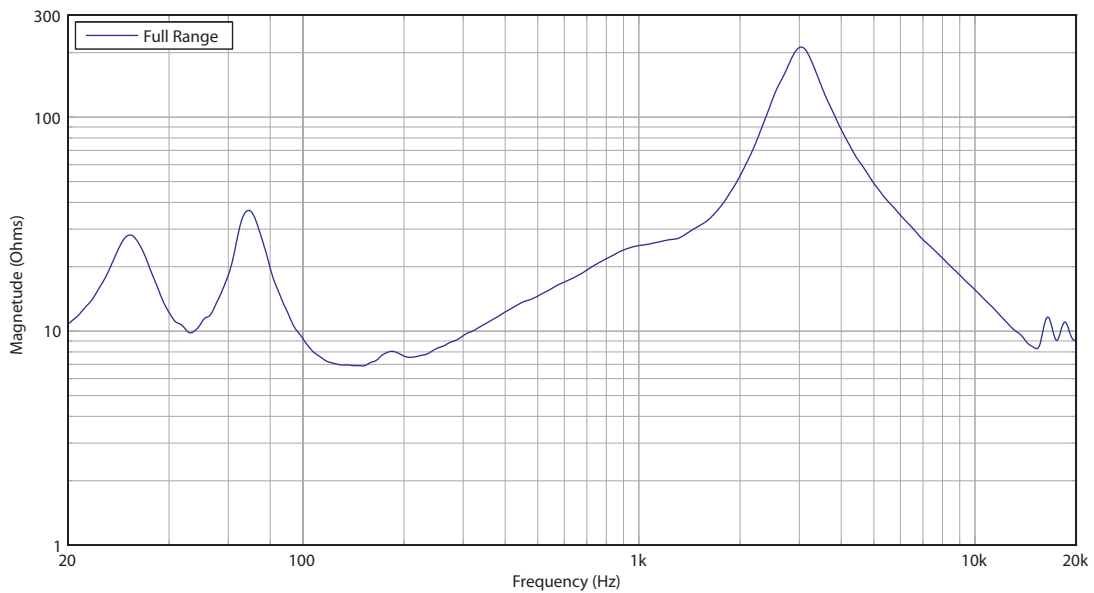

Install Speakers

ATHENS TCS122/64

Arrayable 2 Way
12" Full Range Loudspeaker with
Dendritic Waveguide for
Installation Applications,
60° H x 40° V Dispersion

Horizontal Beamwidth

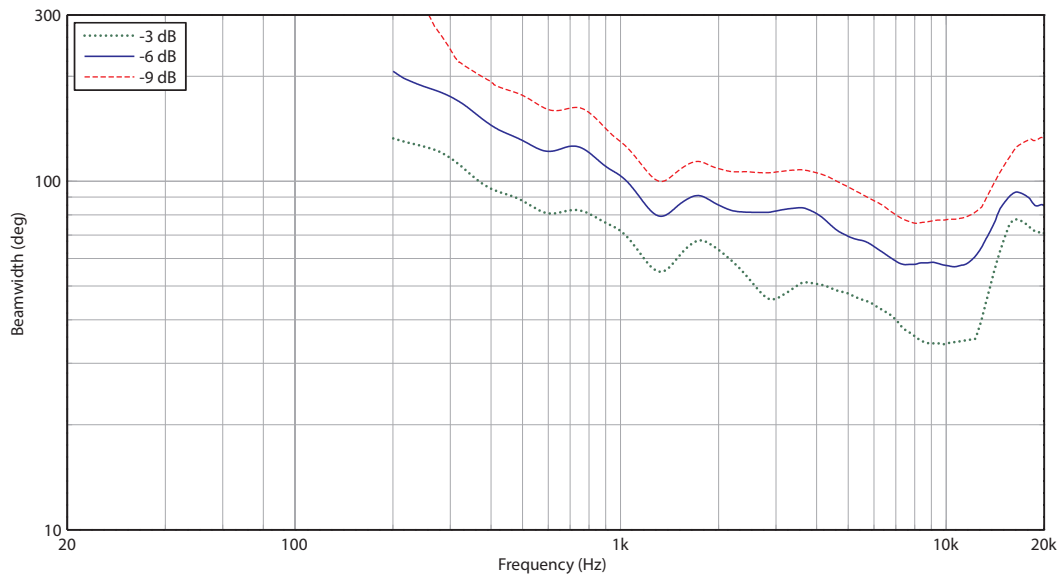

Vertical Beamwidth

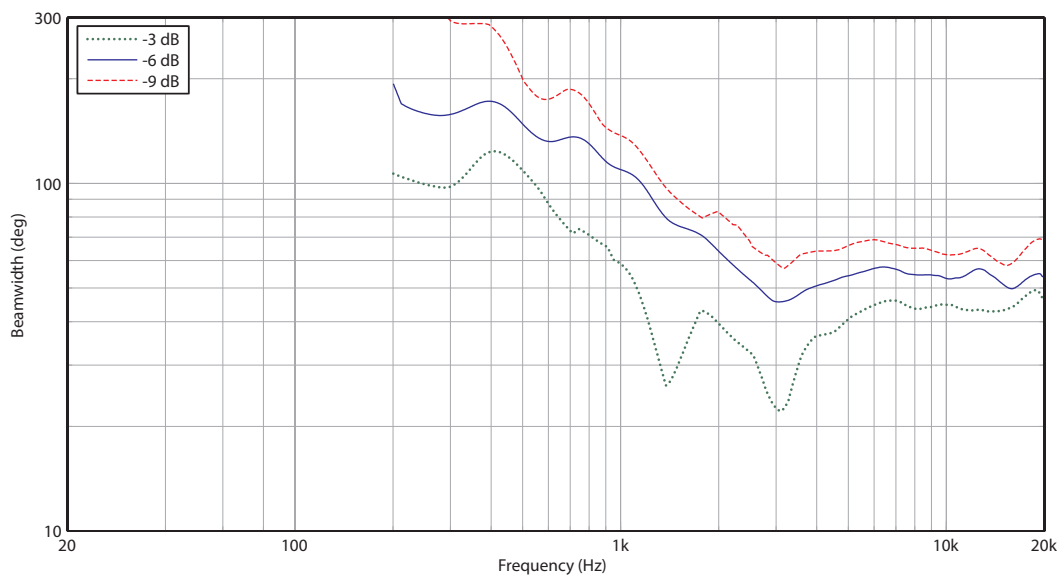

Install Speakers

ATHENS

TCS122/64

Arrayable 2 Way
12" Full Range Loudspeaker with
Dendritic Waveguide for
Installation Applications,
60° H x 40° V Dispersion

Horizontal Polar Plots

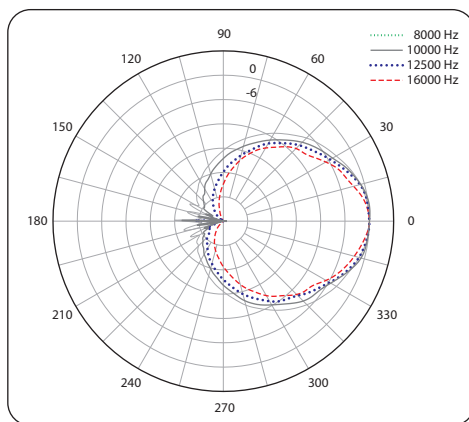
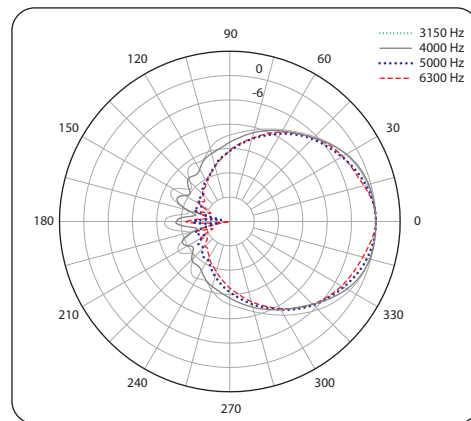
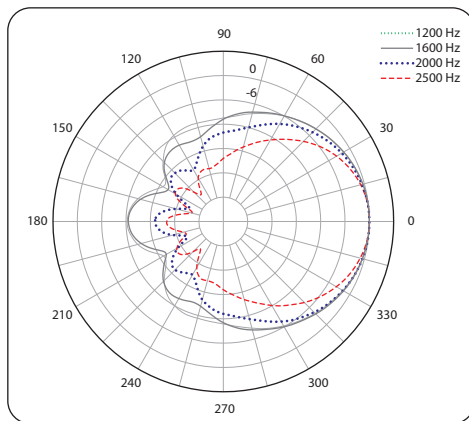
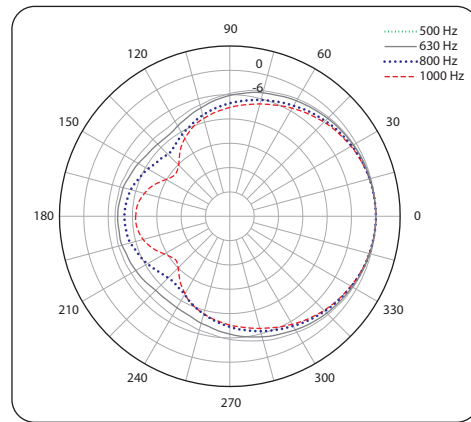
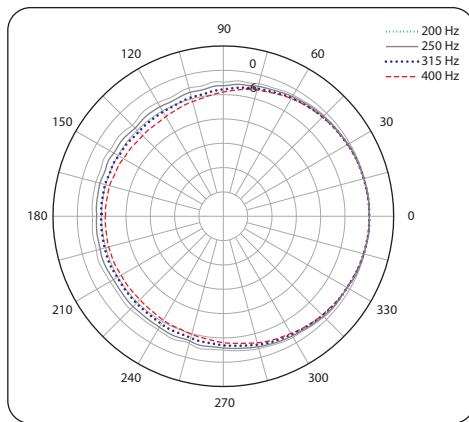

Install Speakers

ATHENS TCS122/64

Arrayable 2 Way
12" Full Range Loudspeaker with
Dendritic Waveguide for
Installation Applications,
60° H x 40° V Dispersion

Vertical Polar Plots

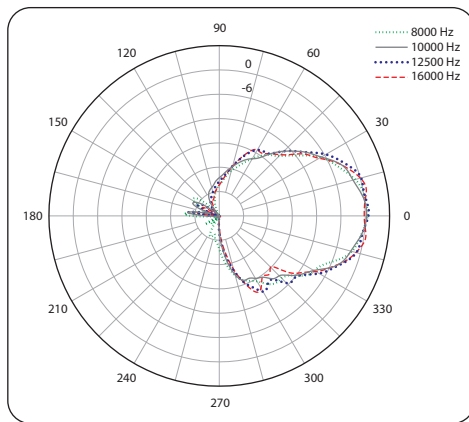
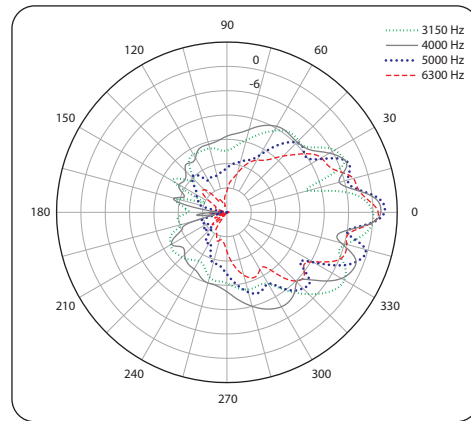
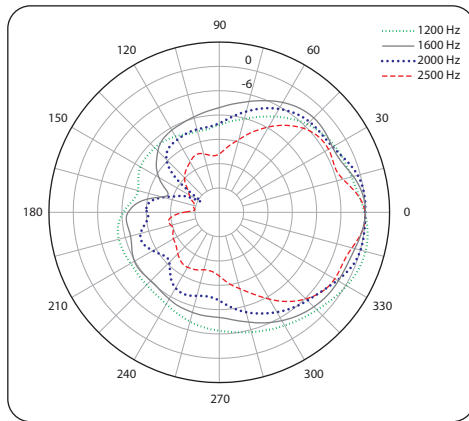
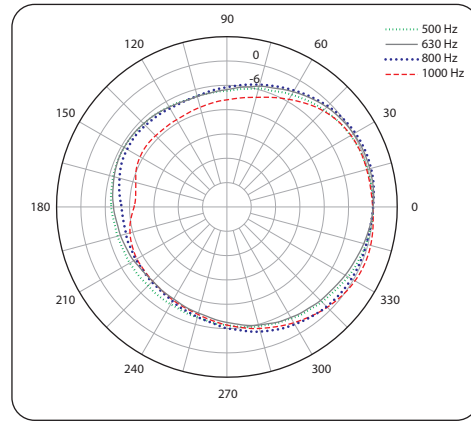
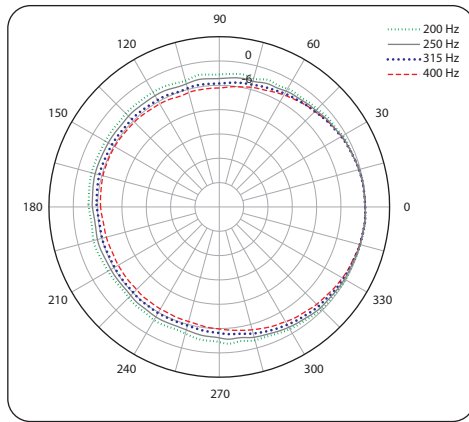

Install Speakers

ATHENS

TCS122/64

Arrayable 2 Way
 12" Full Range Loudspeaker with
 Dendritic Waveguide for
 Installation Applications,
 60° H x 40° V Dispersion

Dimensions

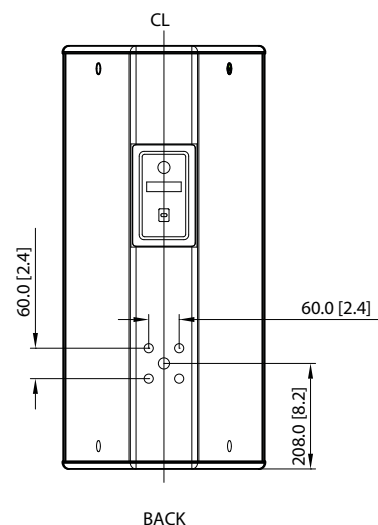
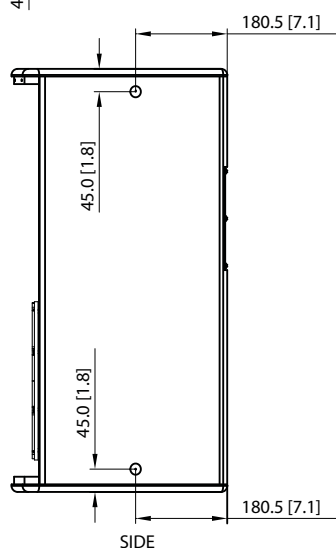
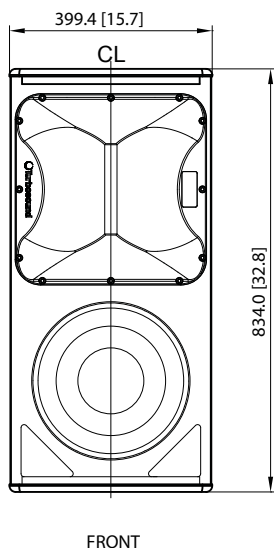
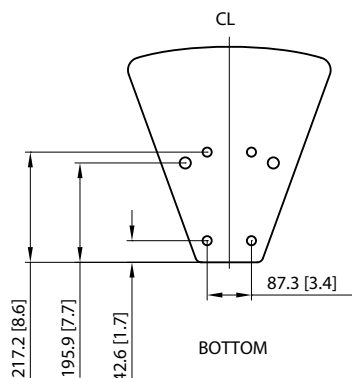
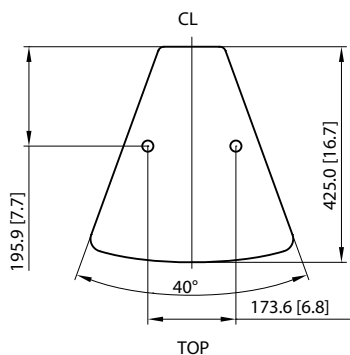

Install Speakers

ATHENS

TCS122/64

Arrayable 2 Way
 12" Full Range Loudspeaker with
 Dendritic Waveguide for
 Installation Applications,
 60° H x 40° V Dispersion

Mounting and Rigging

The cabinet is fitted with M8 x 8 and M10 x 9 internally-threaded rigging points that allow it to be rigged with optional shoulder eyebolts and mounted in many different configurations in permanent installations. The simplest method of rigging is to use the two M10 rigging points on the top, and a single pull-back rigging point in the centre of the rear panel. Adjustment of the length of the rear cable allows the cabinet to be angled for optimum room coverage.

Cabinets may also be hung upside down if required. The cabinet is compatible with industry standard wall and ceiling brackets which use 60 mm x 60 mm hole spacing.

An array of two or more cabinets can be configured using optional Turbosound flyplates and inter-cabinet couplers. These are fixed to the cabinet sides through the M10 rigging points, and assembled together in a 'daisy chain' fashion to build up the required array. The horns of each cabinet may be rotated through 90 degrees to optimise the coverage.

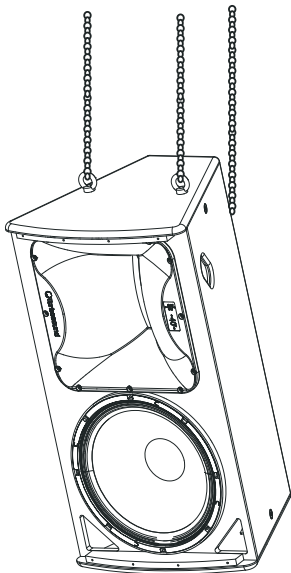

Suspension using M10 shoulder eyebolts on top and one at the rear.

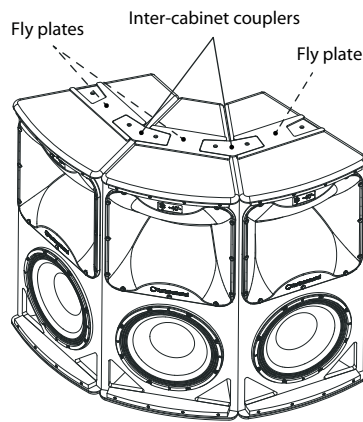

Horizontal clusters using fly plates and inter-cabinet couplers on top and bottom.

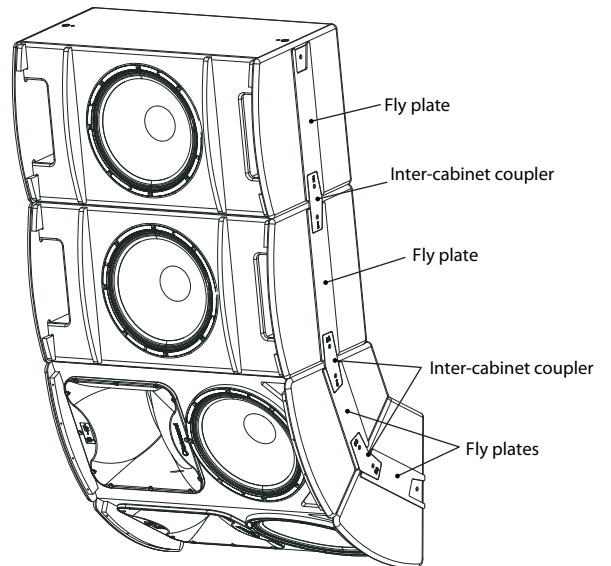

Vertical array using fly plates and inter-cabinet couplers on left and right.

Install Speakers

ATHENS

TCS122/64

Arrayable 2 Way
12" Full Range Loudspeaker with
Dendritic Waveguide for
Installation Applications,
60° H x 40° V Dispersion

Technical Specifications

System

Frequency Response	50 Hz - 18 kHz \pm 3 dB 45 Hz - 20 kHz -10 dB
Nominal Dispersion	60° H x 40° V @ -6 dB points, rotatable
Directivity Factor (Q)	18.3
Directivity Index (DI)	12.6
Power Handling (IEC)	
Passive	600 W continuous, 2400 W peak
Bi-amp	LF: 600 W continuous, 2400 W peak HF: 75 W continuous, 300 W peak
Sensitivity	96 dB (1 W @ 1 m)
Maximum SPL	
Passive	124 dB continuous, 130 dB peak
Bi-Amp	LF: 124 dB continuous, 130 dB peak HF: 128 dB continuous, 134 dB peak
Impedance	
Passive	8 Ω
Bi-Amp	LF: 8 Ω HF: 6 Ω
Crossover Type	Passive / bi-amp, switchable
Components	1 x 12" (312 mm) LF driver 1 x 1.4" (36 mm) HF compression driver

Enclosure

Connectors	1 x Neutrik speakON* NL4, 1 x barrier strip terminals
Wiring	
Passive	Pins 1+ / 1- input, pins 2+ / 2- link
Bi-Amp	Pins 1+ / 1- LF, pins 2+ / 2- HF
Dimensions HWD	834 x 399 x 425 mm (32.8 x 15.7 x 16.7")
Net Weight	26.5 kg (58.4 lbs)
Construction	15 mm (5/8") birch plywood
Finish	Semi matt black paint
Grille	Powder coated perforated steel
Flying Hardware	M10 x 9, M8 X 8 points

Accessories

TCS122-FP (WH) fly plate kit for TCS122

TCS-FK1 (WH) inter-cabinet coupler kit for TCS122 or TCS152

TCS-FK2 (WH) inter-cabinet coupler kit for TCS115B with TCS122 or TCS152

Install Speakers

ATHENS

TCS122/64

Arrayable 2 Way
12" Full Range Loudspeaker with
Dendritic Waveguide for
Installation Applications,
60° H x 40° V Dispersion

Architecture & Engineering Specifications

The speaker shall be of the full range, two-way switchable bi-amp/passive type consisting of one 12" (312 mm) LF driver and one 1.4" (36 mm) HF compression driver. Performance specifications of a typical production unit shall meet or exceed the following: frequency response, measured with swept sine wave input, shall be flat within ± 3 dB from 50 Hz to 18 kHz and within -10 dB from 45 Hz to 20 kHz. Nominal dispersion, at -6 dB points, shall average 60° H x 40° V, rotatable. Nominal impedance shall be HF: 6 Ohms, LF: 8 Ohms; passive: 8 Ohms. Power handling shall be HF: 75 Watts continuous, 300 Watts peak, LF: 600 Watts continuous, 2,400 Watts peak; passive: 600 Watts continuous, 2,400 Watts peak. Sensitivity, measured on axis, mean averaged over stated bandwidth, shall be 96 dB, 1 Watt @ 1 metre. Maximum SPL (peak), measured at 1 metre with music program at stated amplifier input, shall be HF: 134 dB, LF: 130 dB; passive: 130 dB. Dimensions: 834 mm high x 399 mm wide x 425 mm deep (32.8" x 15.7" x 16.7"). Net weight: 26.5 kg (58.4 lbs). The loudspeaker system shall be the TURBOSOUND TCS122/64. No other loudspeaker shall be acceptable unless submitted data from an independent test laboratory verifies that the above combined performance / size specifications are equaled or exceeded.

Install Speakers

ATHENS TCS122/64

Arrayable 2 Way
12" Full Range Loudspeaker with
Dendritic Waveguide for
Installation Applications,
60° H x 40° V Dispersion



Install Speakers

ATHENS

TCS122/64

Arrayable 2 Way
12" Full Range Loudspeaker with
Dendritic Waveguide for
Installation Applications,
60° H x 40° V Dispersion

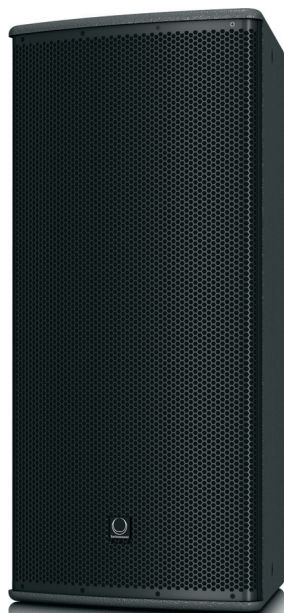

Install Speakers

ATHENS TCS122/64

Arrayable 2 Way
12" Full Range Loudspeaker with
Dendritic Waveguide for
Installation Applications,
60° H x 40° V Dispersion

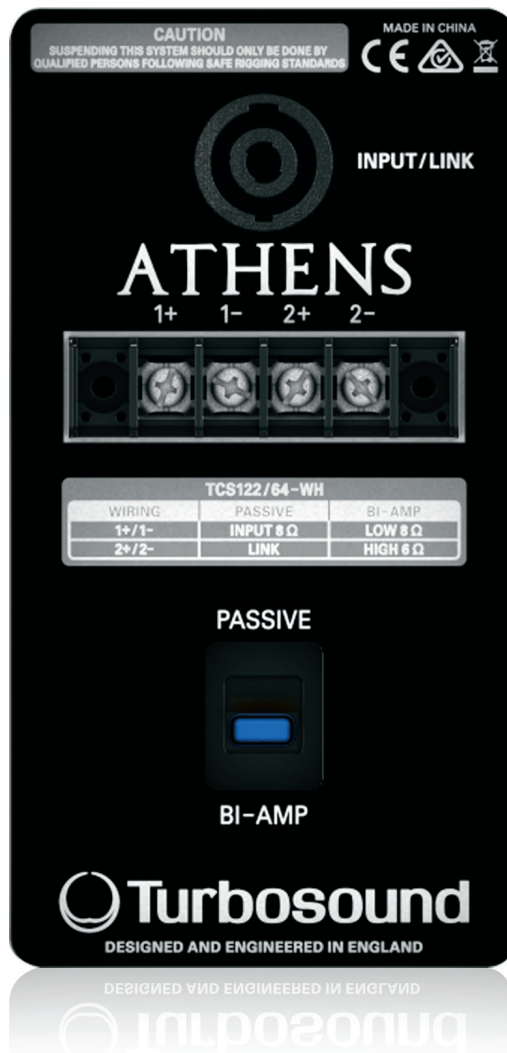

For service, support or more information contact the TURBOSOUND location nearest you:

Europe
MUSIC Group Services UK
Tel: +44 156 273 2290
Email: CARE@music-group.com

USA/Canada
MUSIC Group Services NV Inc.
Tel: +1 702 800 8290
Email: CARE@music-group.com

Japan
MUSIC Group Services JP K.K.
Tel: +81 3 6231 0454
Email: CARE@music-group.com

MUSIC Group accepts no liability for any loss which may be suffered by any person who relies either wholly or in part upon any description, photograph, or statement contained herein. Technical specifications, appearances and other information are subject to change without notice. All trademarks are the property of their respective owners. MIDAS, KLARK TEKNIK, TURBOSOUND, BEHRINGER, BUGERA and DDA are trademarks or registered trademarks of MUSIC Group IP Ltd. © MUSIC Group IP Ltd. 2015 All rights reserved.

This file was downloaded from the site
mans.io

Instruction manuals and user guides

[Samsung](#)

[Pioneer](#)

[Alpine](#)

[LG](#)

[Dell](#)

[Sharp](#)

[Sony](#)

[Philips](#)

[Epson](#)

[Netgear](#)