

# WIR SYS 3

## SoundPlus® Value Courtroom System ADA Courtroom Assistive Listening System



The Value Courtroom System, model WIR SYS 3, is the ideal hearing assistance package for courtrooms with limited budget resources. Participants wear headset style receivers to listen to the courtroom proceeding at the volume of their comfort level anywhere up to 28,000 sq. ft. For the severely hard of hearing, the RX22-4 receiver can be used with a neckloop (included) to amplify the participant's telecoil equipped hearing aid. SoundPlus infrared technology ensures privacy and security: the message of the proceeding will not travel outside the walls of the courtroom.

Each WIR SYS 3 package includes: one (1) TX9 emitter, one (1) MOD 232 modulator, three (3) underchin RX18 receivers, one (1) RX22-4 receiver, one (1) EAR 022, one (1) CHG 518 charger, one (1) NKL 001 neckloop and one (1) RPK 005 rack panel kit. The WIR SYS 3 meets and exceeds government ADA regulations for public hearing assistance, and is backed by a five-year warranty.\*

# SoundPlus® Value Courtroom System

## MOD 232 Modulator

<b>Size, Weight:</b>	8.5" W x 8.2" D x 1.7" H (21.5 cm x 20.8 cm x 4.4 cm), 31 lbs (1.5 kg)
<b>Color:</b>	Black epoxy paint with white legends (optional white enclosure available)
<b>Rack Mount:</b>	1/2 rack space wide, 1 rack space high, one or two modulators may be mounted in a single IEC rack space with RPK 005 (single) or RPK 006 (double) Rack Mount Kits
<b>Power Supply:</b>	Wall Transformer, 24VAC, 50-60 Hz, 15VA North America: TFP 016, UL/CSA Europe: TFP 027-01, 2-pin Schuko plug, CE UK: TFP 027-02, 3-pin UK plug, CE
<b>Modulation:</b>	FM Wideband, +50kHz deviation, 50uS pre-emphasis
<b>Carrier Frequency:</b>	Channel A: Selectable, 2.3/2.8/3.3/3.8 MHz, Channel B: Selectable, 2.3/2.8/3.3/3.8 MHz
<b>Signal-to-Noise Ratio:</b>	More than 60dB
<b>Frequency Response:</b>	30 to 16,000 Hz, +1 dB, -3 dB, electrical response
<b>Total Harmonic Distortion:</b>	Less than 2%, electrical response
<b>Audio Processing:</b>	Compression (slope) adjustable from 1:1 or 2:1 Switchable compression gain: Moderate: 16 dB. Max: 33 dB
<b>Auto Carrier Shut-Off:</b>	15-minute timer shuts off carrier when no audio is present (can be disabled)

## MOD 232 Front Panel

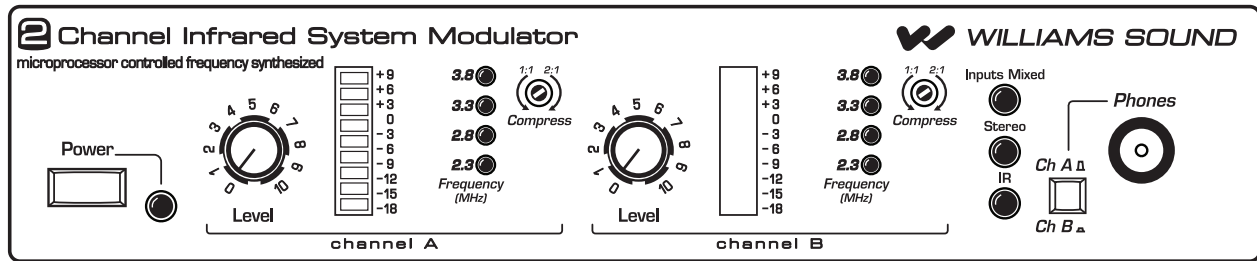

A133

<b>Power Switch:</b>	Two-position push button, ON/OFF
<b>Power Indicator:</b>	Green LED
<b>Audio Level Controls:</b>	CHA and CHB Input Level, rotary knobs
<b>Audio Indicators:</b>	CHA and CHB Audio Level, 10-segment LED's
<b>Carrier LEDs:</b>	4 green LED carrier "on" indicators per channel (indicates frequency, malfunctions)
<b>Compress Control:</b>	1:1 or 2:1
<b>Input Mix LED:</b>	Indicates inputs A and B audio are mixed and transmitted by CHA, CHB off
<b>Stereo LED:</b>	Indicates stereo mode
<b>Phones Switch:</b>	Selects CH1 or CH2 for phones when not in stereo mode
<b>Phones Output:</b>	1/4" TRS headphone jack. Accepts stereo, mono, and any impedance phones.
<b>Infrared Test LED:</b>	IR LED for receiver testing, monitoring, and audio signal testing.

**NOTE: SPECIFICATIONS SUBJECT TO CHANGE WITHOUT NOTICE!**

\*90 days on accessories

# SoundPlus® Value Courtroom System

## MOD 232 Rear Panel

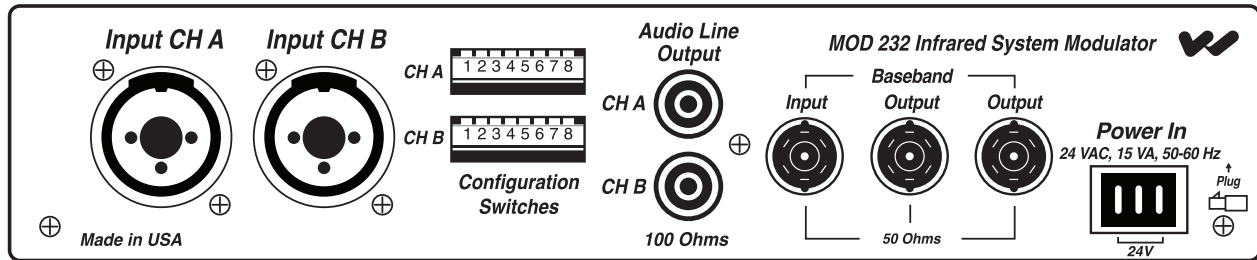

A134

<b>Power Input:</b>	3-Pin Molex, 24 VAC, 50-60 Hz, 15 VA
<b>Audio Input Jack:</b>	CHA and CHB combination XLR/TRS jack
<b>Mic Level:</b>	Balanced, Lo-Z, 100 $\mu$ V min. to 90 mV max., 1mV nominal, 3 k $\Omega$ input impedance, supplies switchable simplex power per DIN 45596 for condenser mics
<b>Line Level:</b>	Balanced or unbalanced, 21 mV min. to 10 V max., 212 mV nominal, 100 k $\Omega$
<b>Audio Line Output Jacks:</b>	RCA Jack, CHA and CHB, 500 mV, unbalanced, 100 $\Omega$ source impedance, load impedance must be greater than 1k $\Omega$
<b>Configuration Switches:</b>	CHA and CHB 8-position DIP switch, selects Mic/Line input, compressor gain, simplex power, discrete or mixed inputs, carrier frequency, channel disable, auto shut-off timer
<b>Baseband Input Jack:</b>	BNC, allows mixing with additional MOD 232 Modulator (4CH operation), 100mV, 50 $\Omega$ input impedance, use with MOD 232, BNC, RG-58 Cable
<b>Baseband Output Jack:</b>	Two BNC jacks carry baseband signal, 100 mV/channel, 50 $\Omega$ source impedance, for use with WIR TX9 or MOD 232 only
<b>Approvals:</b>	CE, FCC, RoHS, WEEE
<b>Operating Requirements:</b>	0-50° C ambient temperature, non-condensing, non-corrosive atmosphere
<b>Warranty:</b>	5 years on modulator, 90 days on accessories

## WIR TX9 Emitter:

<b>Dimensions, Weight:</b>	11.25" W x 6.25" H x 2.125" D (28.6 cm x 15.9 cm x 5.4 cm), 1.9 lbs (0.9 kg)
<b>Color:</b>	Black with white legends, red acrylic lens (optional white enclosure available)
<b>Power Supply:</b>	Wall Transformer, 24 VAC, 50-60 Hz, 35 VA, 3-pin MOLEX Connector North America: TFP 010, UL/CSA Europe: TFP 027-01, 2-pin Schuko plug, CE UK: TFP 027-02, 3-pin UK plug, CE Note: Each WIR TX9 requires its own power supply
<b>Power Cable:</b>	NEC Class 2 wiring, two-conductor, 18 ga, 200' (61 m) max. length
<b>Indicators:</b>	Green LED power indicator, red LED baseband indicator
<b>Carrier Frequency:</b>	50 kHz to 8 MHz
<b>Emitter IR Power:</b>	3.5 watts
<b>Coverage Area:</b>	Up to 28,000 sq.ft. (2,600 m <sup>2</sup> ) in single-channel mode when using the RX22-4 Receiver Up to 18,000 sq.ft. (1,700 m <sup>2</sup> ) in two-channel mode when using the RX22-4 Receiver Up to 3,063 sq.ft. (285 m <sup>2</sup> ) in single-channel mode when using the RX18 Receiver (See coverage area diagrams)
<b>Baseband Input:</b>	BNC, 100 mV per carrier, 50 $\Omega$ , for use with WIR TX9 or MOD 232 only
<b>Baseband Output:</b>	BNC, 50 $\Omega$ , for use with TX9 only
<b>Baseband Cable:</b>	RG 58 Coax, BNC connectors, maximum 1000' (300 m) length
<b>Operating Requirements:</b>	0-50° C ambient temperature, non-condensing, non-corrosive atmosphere
<b>Mounting Kits:</b>	Wall or Ceiling Mount: BKT 024 Omnidirectional mount, Mic Stand Kit: SS-11 or SS-6
<b>Warranty:</b>	5 years on Emitter, 90 days on accessories
<b>Approvals:</b>	CE, FCC, RoHS, WEEE
<b>Compatible Receivers:</b>	WIR RX22-4 Four-Channel Receiver, RX18 two-Channel Receiver

**NOTE: SPECIFICATIONS SUBJECT TO CHANGE WITHOUT NOTICE!**

# SoundPlus® Value Courtroom System

## WIR TX9 Rear Panel

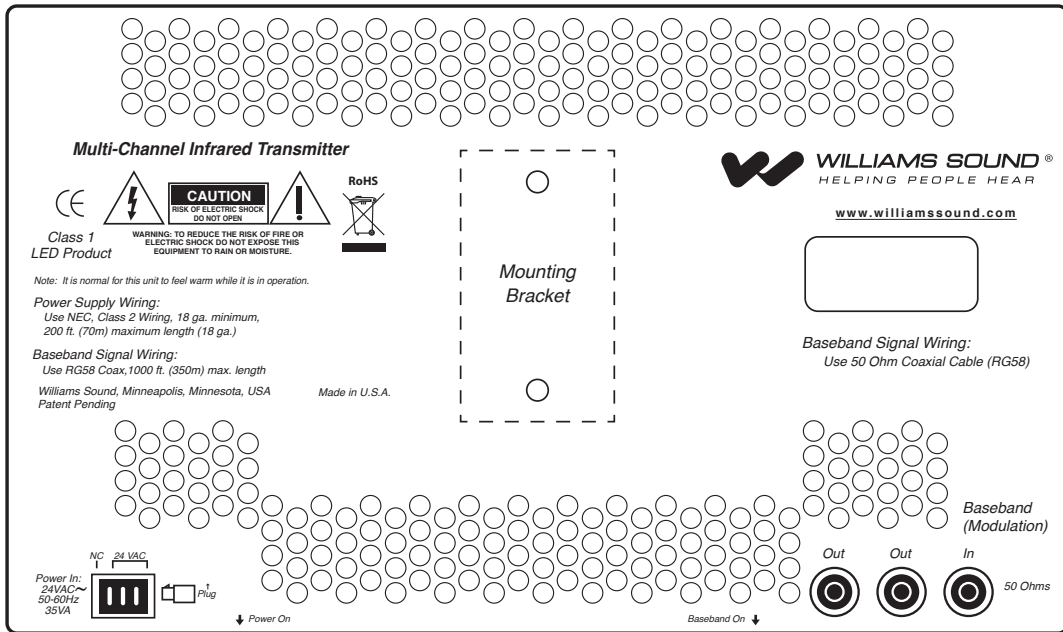

A135

## Receiver Coverage Area with TX9 Emitter in Single Channel Mode

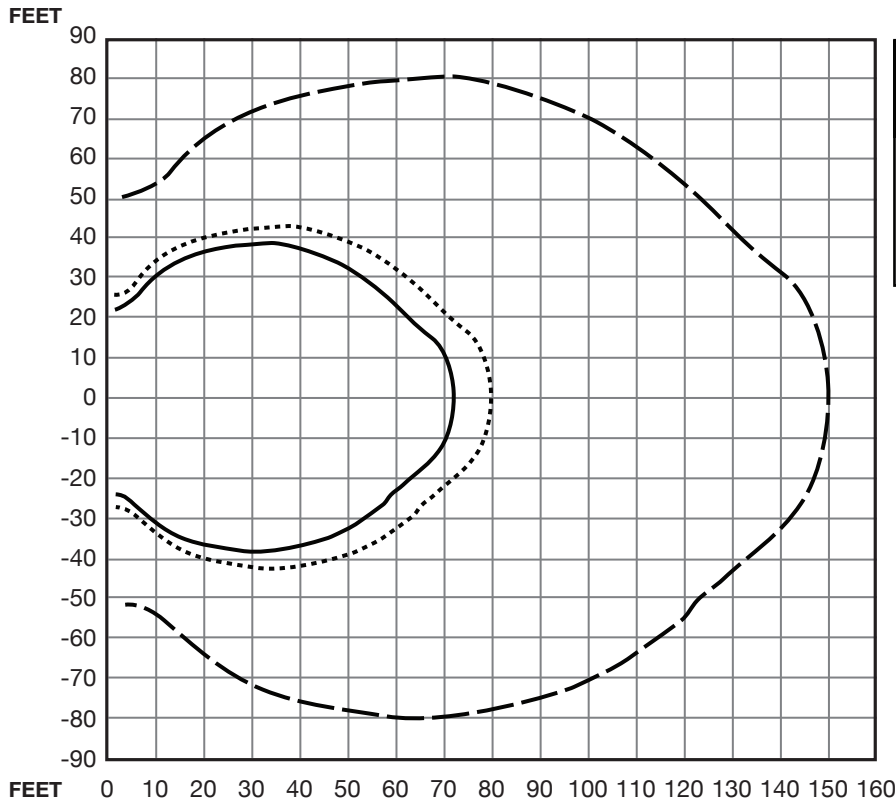

**RECEIVER COVERAGE AREA WITH TX9 OR TX90 TRANSMITTER IN SINGLE CHANNEL MODE**

- — — RX22-4 RECEIVER
- ..... RX15-2 RECEIVER
- RX18 RECEIVER

A136

The coverage area for the TX9 will vary depending on the receiver being used. The diagram above demonstrates the receiver coverage when operating a single TX9 emitter in single channel mode. Patterns are direct radiation patterns.

**Note: Reflections of the infrared light from walls, ceilings and floors may change these patterns.**

# SoundPlus® Value Courtroom System

## WIR RX22-4 Receiver

**RX22-4 TOP**

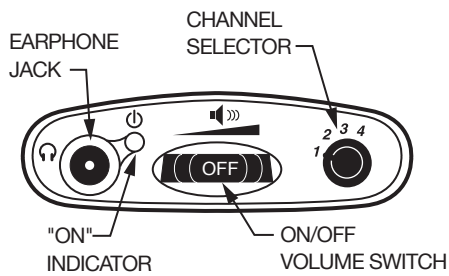

**RX22-4 FRONT**

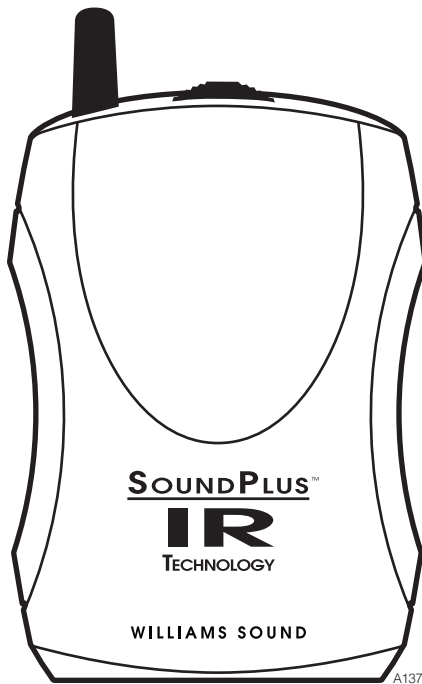

<b>Receiver Style:</b>	Body-Pack, dual-lens detector, lanyard
<b>Size:</b>	4.5" L x 2.85" W x 1.2" H (114.3 mm x 72.4 mm x 30.4 mm)
<b>Weight:</b>	4.6 oz (130 g) with batteries
<b>Color and Material:</b>	Black
<b>Lanyard:</b>	3 ft (.91 m), allows receiver to be worn around the neck
<b>Operating Temperature:</b>	-10° C to +50° C
<b>Battery Type:</b>	2 x AA, alkaline (BAT 001) or NiMH (BAT 026)
<b>Battery Life:</b>	Alkaline: 60 hours, NiMH: 30 hours/charge
<b>Battery Drain:</b>	25 mA, nominal
<b>Charging Contacts:</b>	For use only with CHG 3512
<b>Carrier Frequency:</b>	Channel 1: 2.3 MHz, Channel 2: 2.8 MHz Channel 3: 3.3 MHz, Channel 4: 3.8 MHz
<b>De-Emphasis:</b>	50 uS
<b>FM Deviation:</b>	±50 kHz
<b>Signal-to-Noise Ratio:</b>	60dB min.
<b>Squelch:</b>	Receiver squelches (mutes) at 40 dB S/N ratio
<b>Frequency Response:</b>	25 Hz to 16 KHz, +1 dB, -3 dB, electrical response
<b>Total Harmonic Distortion:</b>	Less than 1%, electrical response
<b>Controls:</b>	ON/OFF/VOLUME: combination thumbwheel knob Channel Selector: four-position rotary switch
<b>Indicators:</b>	Red LED "ON" indicator, flashes to indicate Low battery
<b>Audio Output Jacks:</b>	3.5 mm stereo mini phone jack Accepts 3.5 mm mono or stereo phone plug
<b>Audio Output Power:</b>	15 mW max at 32 Ω
<b>Acoustic Output:</b>	110 dB SSPL90 w/ EAR 013
<b>Sensitivity:</b>	Better than 1 nW/cm <sup>2</sup> for 40 dB signal-to-noise ratio
<b>Approvals:</b>	CE, FCC, RoHS, WEEE
<b>Warranty:</b>	5 years on receiver, 90 days on accessories
<b>Compatible Headphones/ Earphones:</b>	Mono or stereo, 8-32 ohms, 3.5 mm mini phone plug, HED 021, HED 026, EAR 013, EAR 014, EAR 022, NKL 001

# SoundPlus® Value Courtroom System

## WIR RX18 Receiver

<b>Weight:</b>	2.0 oz (56 g) with battery
<b>Material and Color:</b>	ABS plastic, Black and Grey
<b>Battery Type, Life:</b>	BAT AP07D NIMH Battery Pack, 7 hours
<b>Operating Range:</b>	3,063 sq ft (285 m <sup>2</sup> ) when used with the TX9 emitter or TX90 transmitter in single-channel mode
<b>Modulation Frequency:</b>	2.3 MHz or 2.8 MHz or stereo
<b>Frequency Response:</b>	200 Hz to 8 kHz, ± 5 dB
<b>Signal to Noise Ratio:</b>	60 dB at 10 m
<b>Controls:</b>	Volume control thumbwheel 3-position selection switch (2.3 MHz, 2.8 MHz, stereo)
<b>Acoustic Output:</b>	120 dB MAX SSPL90 with 2 cc coupler
<b>Compatibility:</b>	Compatible with 2.3 MHz and 2.8 MHz IR transmitters, WIR TX900 and WIR TX925 systems
<b>Battery Charger:</b>	CHG 518
<b>Power Switch:</b>	Built into receiver "arms"
<b>Ear pads:</b>	Uses EAR 240 silicon eartips
<b>Approvals:</b>	CE, RoHS
<b>Warranty:</b>	5 years (90 days on battery)

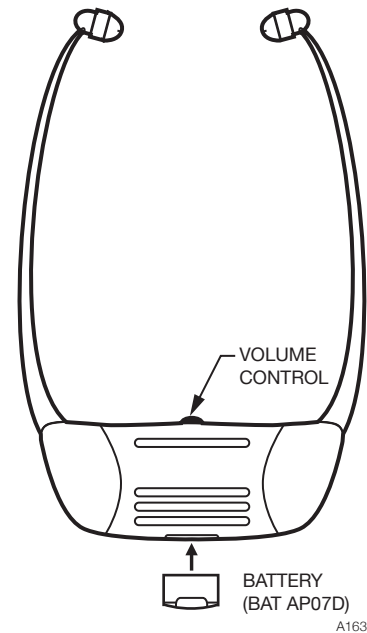
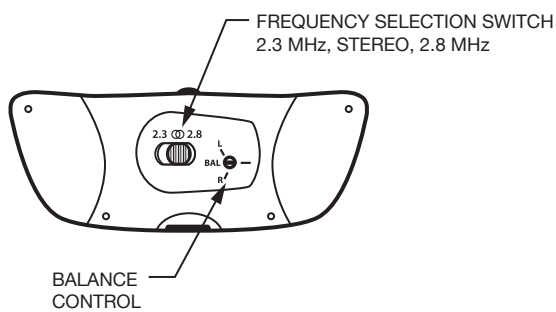

# SoundPlus® Value Courtroom System

## Two-Channel System Diagram

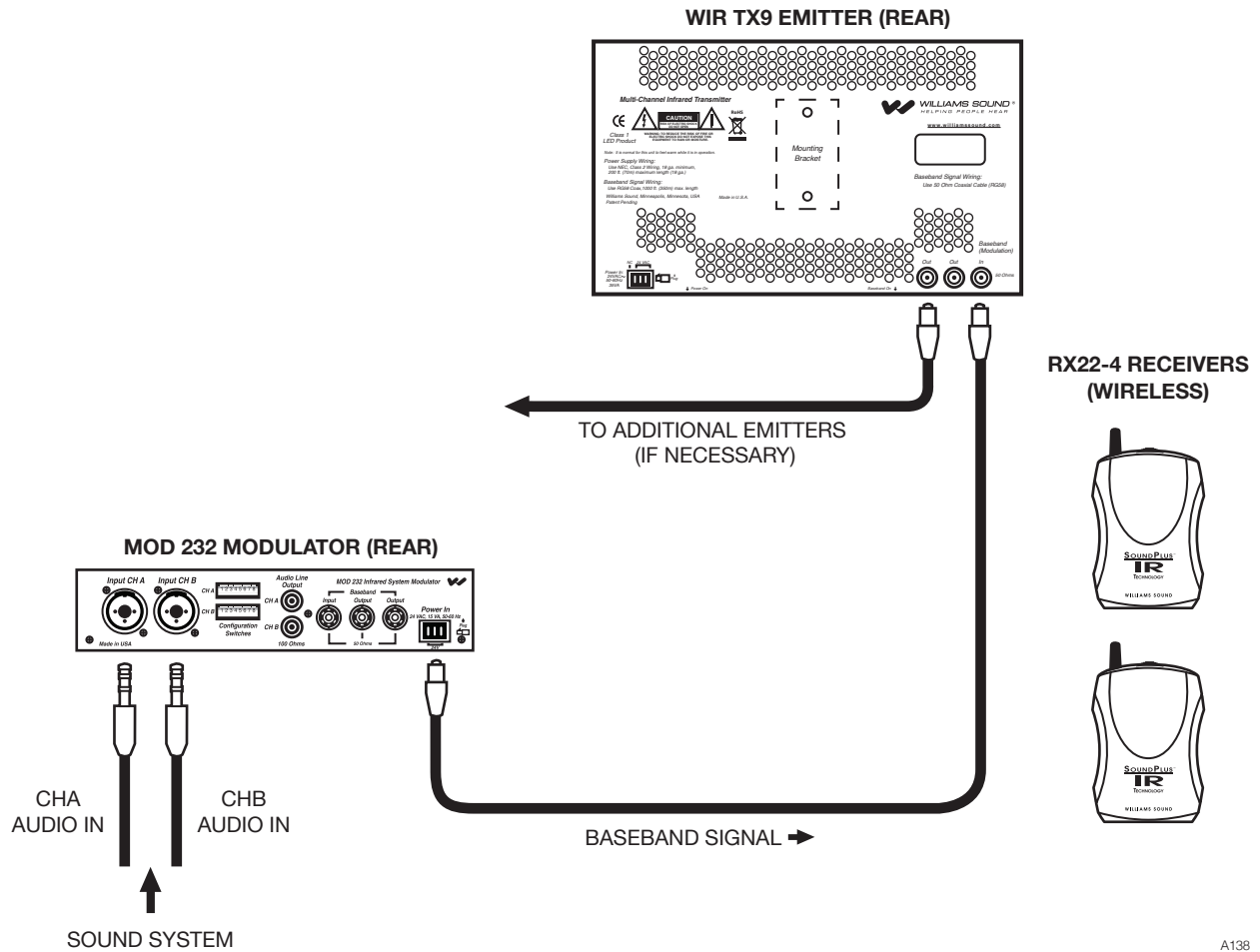

A138

# SoundPlus® Value Courtroom System

## Bid Specs

### Modulator, Model MOD 232

The infrared system shall consist of separate modulator and emitter units, with portable receivers. The modulator unit shall be a half-rack style, metal enclosure. A rack panel shall be available to mount one or two modulator units within a single EIA rack space. An adjustable floor stand and mounting bracket shall be available to mount the modulator and emitter together for portable operation.

The modulator shall provide two channels of selectable FM carrier signals; 2.3/2.8/3.3/3.8 MHz, so that a single modulator can be used to simultaneously transmit up to two channels, and two modulators can be ganged together to transmit up to four channels simultaneously. The carrier signals shall use 50 kHz deviation and 50  $\mu$ S pre-emphasis. The carrier signals (baseband) shall be transmitted to one or more emitters by 50 ohm RG58 coaxial cable with BNC-type connectors. A BNC-type baseband input jack and baseband output jack shall be provided on the modulator.

The modulator shall be powered by an external 24 VAC, 10 VA, 50-60 Hz power supply, connected via a three-pin Molex power connector. It shall have a rocker-type power switch, power LED indicator, four carrier indicator LEDs and two bar graph-type LED audio indicators. The modulator shall have a modulated IR LED on the front panel for testing purposes, and a headphone jack that accommodates mono and stereo 1/4" headphones, and channel monitoring switch. The modulator shall have two rotary audio input level controls, and a screwdriver adjustable control for varying the input compression from 1:1 or 2:1. The modulator shall have two timers that automatically shut off the carriers when there is no audio signal present for 15 minutes. The modulator shall have two combination input jacks that accept 3-pin XLR plugs for balanced microphone input or 1/4" TRS plugs for balanced or unbalanced line-level inputs. The XLR inputs shall be low impedance, accept signal levels from 100  $\mu$ V to 90 mV and supply 15 V simplex power per DIN45596. The TRS jacks shall accept balanced or unbalanced audio signal levels from 21 mV to 10 V. The modulator shall have CE, FCC, RoHS, and WEEE approval and carry a five-year parts and labor warranty.

The modulator shall be the Williams AV model MOD 232.

### Emitter, Model TX9

The emitter shall be contained in a metal enclosure with a shatter-resistant lens. The emitter shall include an omni-directional mounting bracket for permanent installation and a bracket shall be available for mounting on a floor stand for portable installations. Each emitter shall be powered by a 24 VAC, 50 VA, 50-60 Hz power supply. The power connector shall be a 3-pin Molex-type. The emitter shall have a BNC-type 50 ohm baseband input and a BNC-type baseband 50 ohm output jack. The emitter shall have a repeater circuit to allow multiple numbers of emitters to operate from the baseband signal. The emitter shall have a visible LED indicator for power and for baseband signal. Carrier frequency is 50KHz to 8 MHz. The emitter shall shut off when the baseband signal is not present. The emitter shall provide an effective coverage area of up to 28,000 sq ft (2,600 sq m) in single channel mode and up to 18,000 sq ft (1,700 sq m) in two channel mode when using the RX22-4 receiver. The emitter shall be convection-cooled, without fans. The emitter shall have CE, FCC, RoHS, and WEEE approval and carry a five-year warranty on parts and labor.

The emitter shall be Williams AV model WIR TX9.

### Receiver, Model WIR RX18

The receiver shall be an under-chin stetho style with an IR detector lens in the face of the unit. The receiver shall have a rotary type volume control and the power switch shall be built into the arms of the unit so it will automatically shut off when not in use. The receiver shall operate for seven hours per charge with the BAT AP07D NiMH battery pack. The receiver shall be housed in a black and grey plastic case. The receiver shall have a three position selector switch for 2.3 MHz, stereo or 2.8 MHz modulated IR signals. The receiver shall provide 120dB SSPL90 output. The system electrical frequency response shall be 200Hz to 8kHz and the S/N ratio shall be 60dB at 10m. The receiver shall have CE, RoHS and WEEE approval and be covered by a five-year parts and labor warranty (90 days on battery pack).

The receiver shall be the Williams AV model WIR RX18.

### Four-Channel Receiver, Model RX22-4

The receiver shall be a body-pack type with IR detector lens behind face of the unit. The unit shall have a lanyard for hands-free operation. The receiver shall have a rotary-type volume control. The receiver shall operate for 60 hours with two AA alkaline batteries and for 30 hours per charge with NiMH AA batteries. The receiver shall be charged without battery removal via charger contacts in the case. A drop-in charger accessory shall recharge the batteries in 8 hours when used with CHG 3512 charger.

The receiver shall be the Williams AV model WIR RX22-4

**NOTE: SPECIFICATIONS SUBJECT TO CHANGE WITHOUT NOTICE!**

#### Domestic Sales

Williams AV  
10300 Valley View Rd  
Eden Prairie, MN 55344  
Ph: 800-328-6190 / 952-943-2252  
FAX: 952-943-2174  
Email: [info@williamsav.com](mailto:info@williamsav.com)  
Web: [www.williamsav.com](http://www.williamsav.com)

#### International Sales

International Sales Department  
Williams AV  
10300 Valley View Rd  
Eden Prairie, MN 55344 USA  
Phone: +1 952 943 2252  
Fax: +1 952 943 2174  
Email: [info@williamsav.com](mailto:info@williamsav.com)  
Web: [www.williamsav.com](http://www.williamsav.com)

# WILLIAMS AV

[info@williamsav.com](mailto:info@williamsav.com) / [www.williamsav.com](http://www.williamsav.com)  
800-843-3544 / INTL: +1-952-943-2252