

PPM1008

8-Channel, 2 x 800 W Professional Powered Mixer

OWNER'S MANUAL

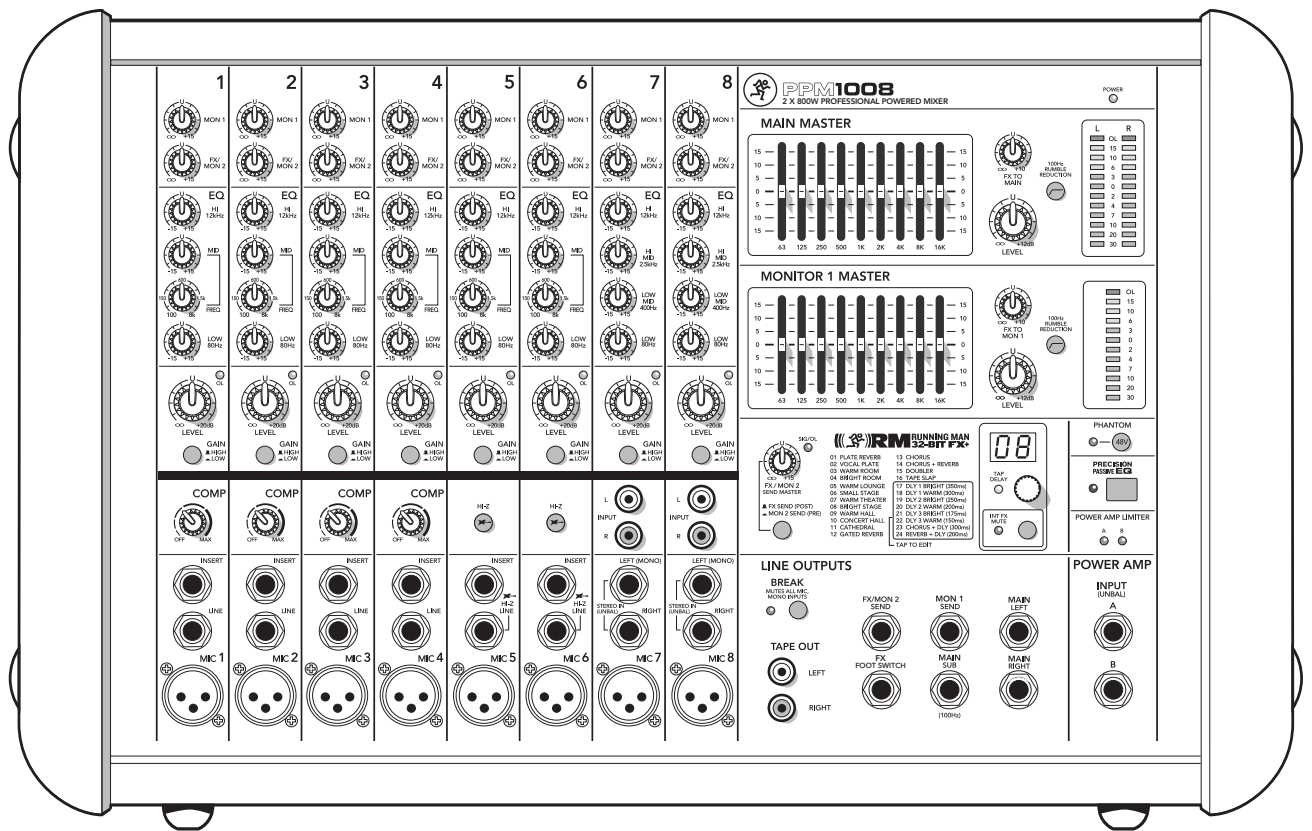

MACKIE®

Important Safety Instructions

1. Read these instructions.
2. Keep these instructions.
3. Heed all warnings.
4. Follow all instructions.
5. Do not use this apparatus near water.
6. Clean only with a dry cloth.
7. Do not block any ventilation openings. Install in accordance with the manufacturer's instructions.
8. Do not install near any heat sources such as radiators, heat registers, stoves, or other apparatus (including amplifiers) that produce heat.
9. Do not defeat the safety purpose of the polarized or grounding-type plug. A polarized plug has two blades with one wider than the other. A grounding-type plug has two blades and a third grounding prong. The wide blade or the third prong are provided for your safety. If the provided plug does not fit into your outlet, consult an electrician for replacement of the obsolete outlet.
10. Protect the power cord from being walked on or pinched particularly at plugs, convenience receptacles, and the point where they exit from the apparatus.
11. Only use attachments/accessories specified by the manufacturer.
12. Unplug this apparatus during lightning storms or when unused for long periods of time.
13. Refer all servicing to qualified service personnel. Servicing is required when the apparatus has been damaged in any way, such as power-supply cord or plug is damaged, liquid has been spilled or objects have fallen into the apparatus, the apparatus has been exposed to rain or moisture, does not operate normally, or has been dropped.
14. Do not overload wall outlets and extension cords as this can result in a risk of fire or electric shock.
15. This apparatus shall not be exposed to dripping or splashing, and no object filled with liquids, such as vases or beer glasses, shall be placed on the apparatus.
16. This apparatus has been designed with Class-I construction and must be connected to a mains socket outlet with a protective earthing connection (the third grounding prong).
17. This apparatus has been equipped with an all-pole, rocker-style AC mains power switch. This switch is located on the rear panel and should remain readily accessible to the user.

	CAUTION AVIS	
RISK OF ELECTRIC SHOCK. DO NOT OPEN RISQUE DE CHOC ELECTRIQUE. NE PAS OUVRIR		
CAUTION: TO REDUCE THE RISK OF ELECTRIC SHOCK DO NOT REMOVE COVER (OR BACK) NO USER-SERVICEABLE PARTS INSIDE. REFER SERVICING TO QUALIFIED PERSONNEL. ATTENTION: POUR EVITER LES RISQUES DE CHOC ELECTRIQUE, NE PAS ENLEVER LE COUVERCLE. AUCUN ENTRETIEN DE PIECES INTERIEURES PAR L'USAGER. CONFIER L'ENTRETIEN AU PERSONNEL QUALIFIE. AVIS: POUR EVITER LES RISQUES D'INCENDIE OU D'ELECTROCUTION, N'EXPOSEZ PAS CET ARTICLE A LA PLUIE OU A L'HUMIDITE		



The lightning flash with arrowhead symbol within an equilateral triangle is intended to alert the user to the presence of uninsulated "dangerous voltage" within the product's enclosure, that may be of sufficient magnitude to constitute a risk of electric shock to persons.
Le symbole éclair avec point de flèche à l'intérieur d'un triangle équilatéral est utilisé pour alerter l'utilisateur de la présence à l'intérieur du coffret de "voltage dangereux" non isolé d'ampleur suffisante pour constituer un risque d'électrocution.



The exclamation point within an equilateral triangle is intended to alert the user of the presence of important operating and maintenance (servicing) instructions in the literature accompanying the appliance.
Le point d'exclamation à l'intérieur d'un triangle équilatéral est employé pour alerter les utilisateurs de la présence d'instructions importantes pour le fonctionnement et l'entretien (service) dans le livret d'instruction accompagnant l'appareil.

WARNING — To reduce the risk of fire or electric shock, do not expose this apparatus to rain or moisture.



Correct disposal of this product. This symbol indicates that this product should not be disposed of with your household waste, according to the WEEE Directive (2012/19/EU) and your national law. This product should be handed over to an authorized collection site for recycling waste electrical and electronic equipment (EEE). Improper handling of this type of waste could have a possible negative impact on the environment and human health due to potentially hazardous substances that are generally associated with EEE. At the same time, your cooperation in the correct disposal of this product will contribute to the effective usage of natural resources. For more information about where you can drop off your waste equipment for recycling, please contact your local city office, waste authority, or your household waste disposal service.

- 18. NOTE:** This equipment has been tested and found to comply with the limits for a Class B digital device, pursuant to part 15 of the FCC Rules. These limits are designed to provide reasonable protection against harmful interference in a residential installation. This equipment generates, uses, and can radiate radio frequency energy and, if not installed and used in accordance with the instructions, may cause harmful interference to radio communications. However, there is no guarantee that interference will not occur in a particular installation. If this equipment does cause harmful interference to radio or television reception, which can be determined by turning the equipment off and on, the user is encouraged to try to correct the interference by one or more of the following measures:

- Reorient or relocate the receiving antenna.
- Increase the separation between the equipment and the receiver.
- Connect the equipment into an outlet on a circuit different from that to which the receiver is connected.
- Consult the dealer or an experienced radio/TV technician for help.

CAUTION: Changes or modifications to this device not expressly approved by LOUD Technologies Inc. could void the user's authority to operate the equipment under FCC rules.

- 19.** This apparatus does not exceed the Class A/Class B (whichever is applicable) limits for radio noise emissions from digital apparatus as set out in the radio interference regulations of the Canadian Department of Communications.

ATTENTION — *Le présent appareil numérique n'émet pas de bruits radioélectriques dépassant les limites applicables aux appareils numériques de class A/de class B (selon le cas) prescrites dans le règlement sur le brouillage radioélectrique édicté par les ministères des communications du Canada.*

- 20.** Exposure to extremely high noise levels may cause permanent hearing loss. Individuals vary considerably in susceptibility to noise-induced hearing loss, but nearly everyone will lose some hearing if exposed to sufficiently intense noise for a period of time. The U.S. Government's Occupational Safety and Health Administration (OSHA) has specified the permissible noise level exposures shown in the following chart. According to OSHA, any exposure in excess of these permissible limits could result in some hearing loss. To ensure against potentially dangerous exposure to high sound pressure levels, it is recommended that all persons exposed to equipment capable of producing high sound pressure levels use hearing protectors while the equipment is in operation. Ear plugs or protectors in the ear canals or over the ears must be worn when operating the equipment in order to prevent permanent hearing loss if exposure is in excess of the limits set forth here.

Duration, per day in hours	Sound Level dBA, Slow Response	Typical Example
8	90	Duo in small club
6	92	
4	95	Subway Train
3	97	
2	100	Very loud classical music
1.5	102	
1	105	Greg and Ben screaming at Troy about deadlines
0.5	110	
0.25 or less	115	Loudest parts at a rock concert

Read This Page!



We realize that you must be keen to try out your new powered mixer, but please read the safety instructions on page 2, and this page first.

Setup

The PPM1008 powered mixer is designed to be easy to operate, and to be set up quickly.

Place the powered mixer in a position where it is easy to reach the controls. All the controls and input connection points are located on the front panel so you can make quick adjustments and connections on stage.

Make sure there is at least 6 inches of airspace behind the powered mixer for ventilation. There are two fans inside the cabinet to cool the power amplifier section. Use the powered mixers in a nice clean and dry environment, free from dryer lint and dust bunnies.

Connections

1. Be sure the rear-panel power switch is off before making any connections.
2. Push the linecord securely into the IEC connector on the rear panel, and plug it into a 3-prong AC outlet that is properly configured for the voltage of your powered mixer.
3. Plug a balanced microphone into one of the mic XLR (3-pin) connectors on the front panel. Or you can connect any line-level signal (keyboard, or guitar preamp) to a line-level input using a TS or a TRS 1/4" plug.
4. You can connect a guitar directly to inputs 5 or 6 without need for a DI box, if you press the hi-z switch on these channels.
5. The insert jacks can be used to connect an external effects or dynamics processor into the signal chain. See page 13 for more details.
6. Plug the speakers (4 ohms or greater) into the speaker output jacks on the rear panel. If you plug two speakers in one side, each speaker must be 8 ohms or greater to maintain a 4-ohm minimum load on the amplifier. Use at least 18 gauge speaker cable with 1/4" TS plugs or Speakon® plugs. For now, set the rear panel power amp mode switch to stereo mains.



Don't use guitar cords for speaker cables! They're not designed to handle speaker-level signals and could overheat.

Ready, steady, go!

1. Turn the channel level, mon 1, and FX/mon 2 controls fully down.
2. Turn down the compressor controls (ch. 1–4).
3. Set all the EQ controls to the center, including the graphic EQ sliders.
4. Turn down the main level and monitor 1 level controls.
5. For each channel, press the gain switch in (low gain) if you are using a line-level source. Press it out (high gain) if you are using a microphone or other low-level source.
6. For condenser mics, push in the phantom power switch. If you are using both condenser and dynamic mics, don't worry. Phantom power will not hurt most dynamic mics. Check the microphone's user manual if you're not sure.
7. Play something into an input at real-world levels, and turn up the channel level to U (unity).
8. In normal playing, the channel's OL LED should only light occasionally. If it stays on for a large portion of your performance, check that the gain switch is set correctly.
9. Slowly turn up the main level control until you hear the signal in your speakers.
10. Repeat steps 5 to 8 for the remaining channels.
11. If needed, apply some EQ wisely.
12. Adjust the levels to get the best mix. Keep the level controls fully down on unused channels.

Other Notes

- Only connect the powered mixer's speaker-level outputs to passive loudspeakers.
- When shutting down, turn off any external amplifiers or powered loudspeakers first. When powering up, turn on any external amplifiers or powered loudspeakers last.
- Save the shipping box!

Please write your serial number here for future reference (i.e., insurance claims, tech support, return authorization, make dad proud, etc.)

Purchased at:

Date of purchase:

Introduction

It is possible that only one person will read this manual all the way through. Hello mom. Here's another manual from your boy.

Thank you for choosing a Mackie professional powered mixer. These powerful mixers are designed to meet the needs of almost any small to medium-sized club, meeting room, sanctuary, or outdoor gathering.

At Mackie, we know what it takes to be roadworthy. After all, our mixers have traveled all over the world under the worst of conditions and the best of conditions, and we've applied what we've learned to the mechanical design of our powered mixers.

Reliability is paramount to sound reinforcement. That's why our engineers have subjected our powered mixers to the most rigorous and fiendish tests imaginable to fine-tune the design and extend its limits beyond those of ordinary mixers or amplifiers.

Features

- Two internal power amplifiers each rated at 800 watts peak at 4 ohms
- Three selectable amplifier modes (stereo main, mono-main/monitor 1, or mon 1/mon 2)
- 8 channels (6 mono, 2 stereo)
- Mic inputs on all channels
- Line-level inputs (6 mono, 2 stereo)
- RCA inputs on stereo channels
- Insert jacks on mono channels
- Channels 5 and 6 allow direct connection of guitars and basses without a DI box
- 3-band EQ with sweepable mid-range frequency on mono channels
- 4-band EQ on stereo channels
- Monitor 1 send
- Main mix stereo line outputs
- Main mix mono sub out
- Amplifier line-level inputs allow the connection of external mixers if more channels are needed
- Footswitch connection for FX mute/unmute
- FX/monitor 2 send (selectable pre/post)
- +48v Phantom power can be applied to all mics
- Built-in compressors on the first 4 mono inputs (dedicated in-line compression)
- 24 built-in Running Man 32-bit effects with input gain, tap delay, and footswitch mute/unmute

- Independent 9-band graphic EQs with constant-Q filters on main and monitor outputs
- Tape/CD stereo RCA outputs
- 12-segment stereo output meters on main mix, and mono meter on monitor 1
- Break switch mutes all mono channels
- Speakon and 1/4" power amp outputs
- Precision passive switch for enhanced clarity and LF response with key Mackie passive speakers
- Polycarbonate sides with built-in metal handles
- Modern and splendidly-stylish powered rabbit hutch design

How To Use This Manual

The first pages after the table of contents are the hookup diagrams. These show typical setups for fun times with your powered mixer.

Next is a detailed tour of the entire mixer. The descriptions are divided into sections, just as your mixer is organized into distinct zones:

- Rear panel: The AC input, power switch, speaker-level outputs and amplifier mode switch
- Patchbay: The lower front section, where you connect microphones and guitars etc.
- Channel Strips: The channel strips where you adjust and control each channel
- Master Section: The section on the right, with graphic EQs and main level controls
- Stereo Effects Processor

Throughout these sections you'll find illustrations with each feature numbered and described in nearby paragraphs.



This icon marks information that is critically important or unique to the mixer. For your own good, read them and remember them.



This icon will lead you to some explanations of features and practical tips. Go ahead and skip these if you need to leave the room in a hurry.

Appendix A: Service information.

Appendix B: Connectors.

Appendix C: Technical information.

Appendix D: Table of Effects Presets

The thickness of the manual makes it ideal for fitting under wobbly table legs. Mackie's technical writers also wear them on their heads, as they make an excellent shield from Venusian mind-probes.

Contents

IMPORTANT SAFETY INSTRUCTIONS	2	MASTER CONTROLS	
READ THIS PAGE!.....	3	36. MAIN MASTER GRAPHIC EQ	20
INTRODUCTION	4	37. FX TO MAIN.....	20
HOOKUP DIAGRAMS.....	6	38. MAIN LEVEL.....	20
REAR PANEL FEATURES	10	39. 100 HZ RUMBLE REDUCTION SWITCH.....	21
1. POWER CONNECTION.....	10	40. MAIN MIX METERS	21
2. POWER SWITCH.....	10	41. MONITOR 1 MASTER GRAPHIC EQ.....	21
3. SPEAKER-LEVEL OUTPUTS.....	10	42. FX TO MON 1	21
4. POWER AMP MODE SWITCH	11	43. MONITOR 1 LEVEL	21
5. VENTILATION AND REAR PANEL.....	11	44. 100 HZ RUMBLE REDUCTION SWITCH.....	21
6. HANDLES	11	45. MONITOR 1 METER	21
FRONT PANEL FEATURES	12	46. PHANTOM SWITCH	22
PATCHBAY		47. PRECISION PASSIVE EQ	22
7. MIC INPUTS.....	12	48. POWER AMP LIMITER LED.....	22
8. MONO LINE INPUTS (CH. 1 TO 4).....	13	STEREO EFFECTS PROCESSOR	
9. LINE/INSTRUMENT INPUTS (CH. 5, 6).....	13	49. FX/MON 2 SEND MASTER.....	22
10. STEREO LINE INPUTS (CH. 7 AND 8).....	13	50. SIG/OL LED	22
11. RCA INPUTS (CH. 7 AND 8)	13	51. FX SEND (POST)/MON 2 SEND (PRE).....	23
12. INSERT (CH. 1 TO 6).....	13	52. PRESET DISPLAY	23
13. TAPE OUTPUTS	13	53. PRESET SELECTOR, TAP DELAY AND LED...	23
14. BREAK SWITCH AND LED	13	54. INTERNAL FX MUTE.....	23
15. FX/MON 2 SEND OUTPUT	14	APPENDIX A: SERVICE INFORMATION.....	24
16. FX FOOTSWITCH	15	APPENDIX B: CONNECTIONS.....	25
17. MON 1 SEND	15	APPENDIX C: TECHNICAL INFORMATION	27
18. MAIN SUB	15	APPENDIX D: TABLE OF EFFECTS PRESETS.....	30
19. MAIN OUTPUTS	15	PPM1008 LIMITED WARRANTY	31
20. POWER AMP INPUTS	15		
CHANNEL CONTROLS			
21. MON 1	17		
22. FX/MON 2	17		
23. HIGH EQ.....	17		
24. MID EQ LEVEL (CH. 1 TO 6).....	17		
25. MID EQ FREQUENCY (CH. 1 TO 6)	17		
26. HIGH MID EQ LEVEL (CH. 7 AND 8).....	17		
27. LOW MID EQ LEVEL (CH. 7 AND 8).....	17		
28. ICE CREAM DISPENSER	17		
29. LOW EQ.....	18		
30. OVERLOAD (OL) LED.....	18		
31. CHANNEL LEVEL	18		
32. GAIN SWITCH	18		
33. COMPRESSOR.....	19		
34. HI-Z SWITCH	19		
35. POWER LED	20		

Need help with your mixer?

- Visit www.mackie.com and click Support to find: FAQs, manuals, addendums, and documentation.
- Email us at: techmail@mackie.com.
- Telephone 1-800-898-3211 to speak with one of our splendid technical support chaps (Monday through Friday, normal business hours, Pacific Time).

Hookup Diagrams

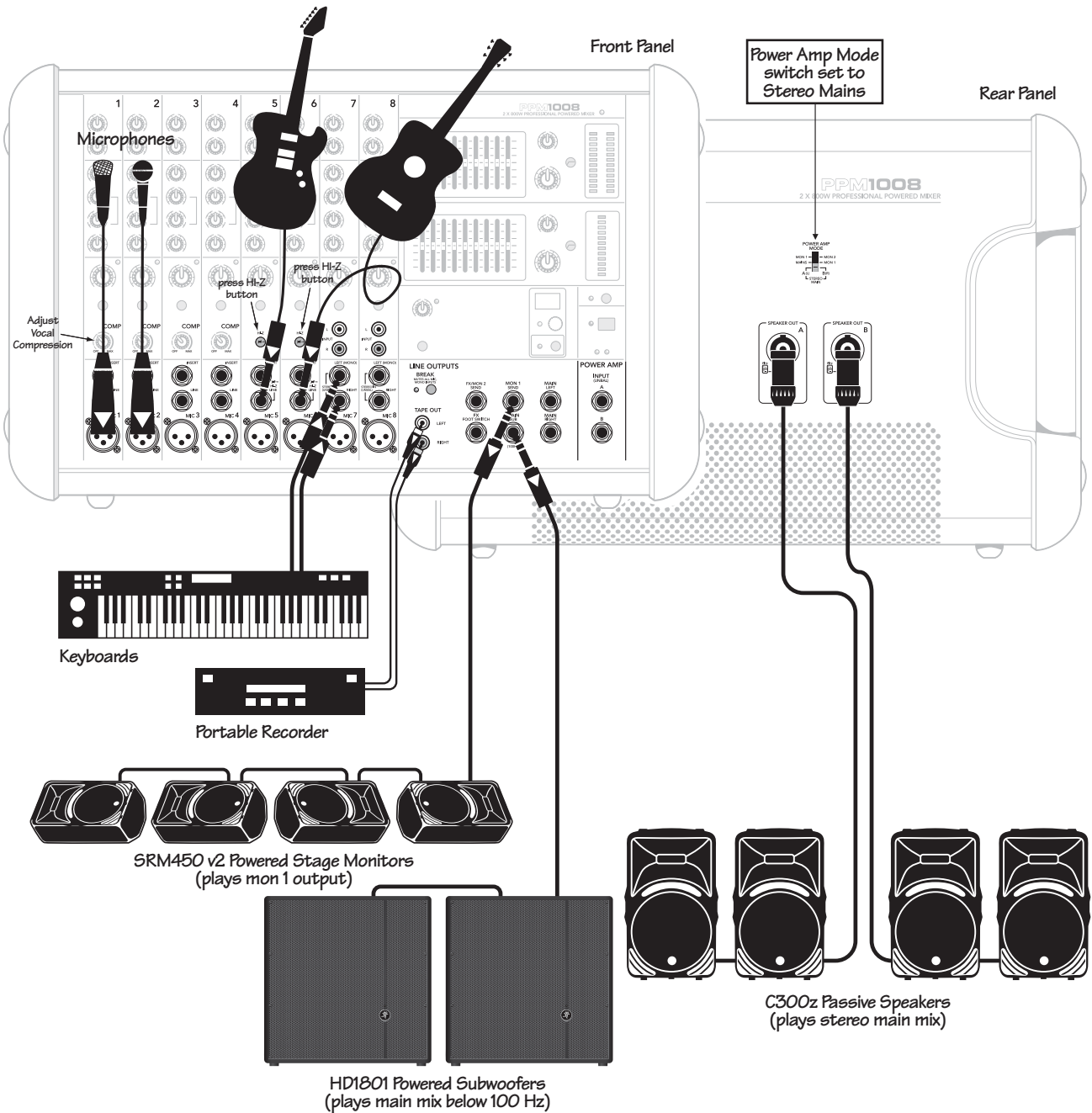

This diagram shows microphones attached to channels 1 and 2, electric guitars connected directly to channels 5 and 6 (with hi-z switch pressed in), and a keyboard attached to channel 7's stereo inputs. A portable recorder is attached to the stereo tape outputs to record the performance.

Mackie SRM450v2 powered monitors are connected to the monitor 1 send, and play as stage monitors. The mon 1 controls of each channel allow you to set up a stage monitor mix that is independent of the main mix.

C300z passive speakers are connected to the speaker-level power output of the powered mixer, and they play the main stereo mix to your audience. HD1801 powered subwoofers are connected to the main mix sub out, to reinforce the low end in your system.

Small Club System

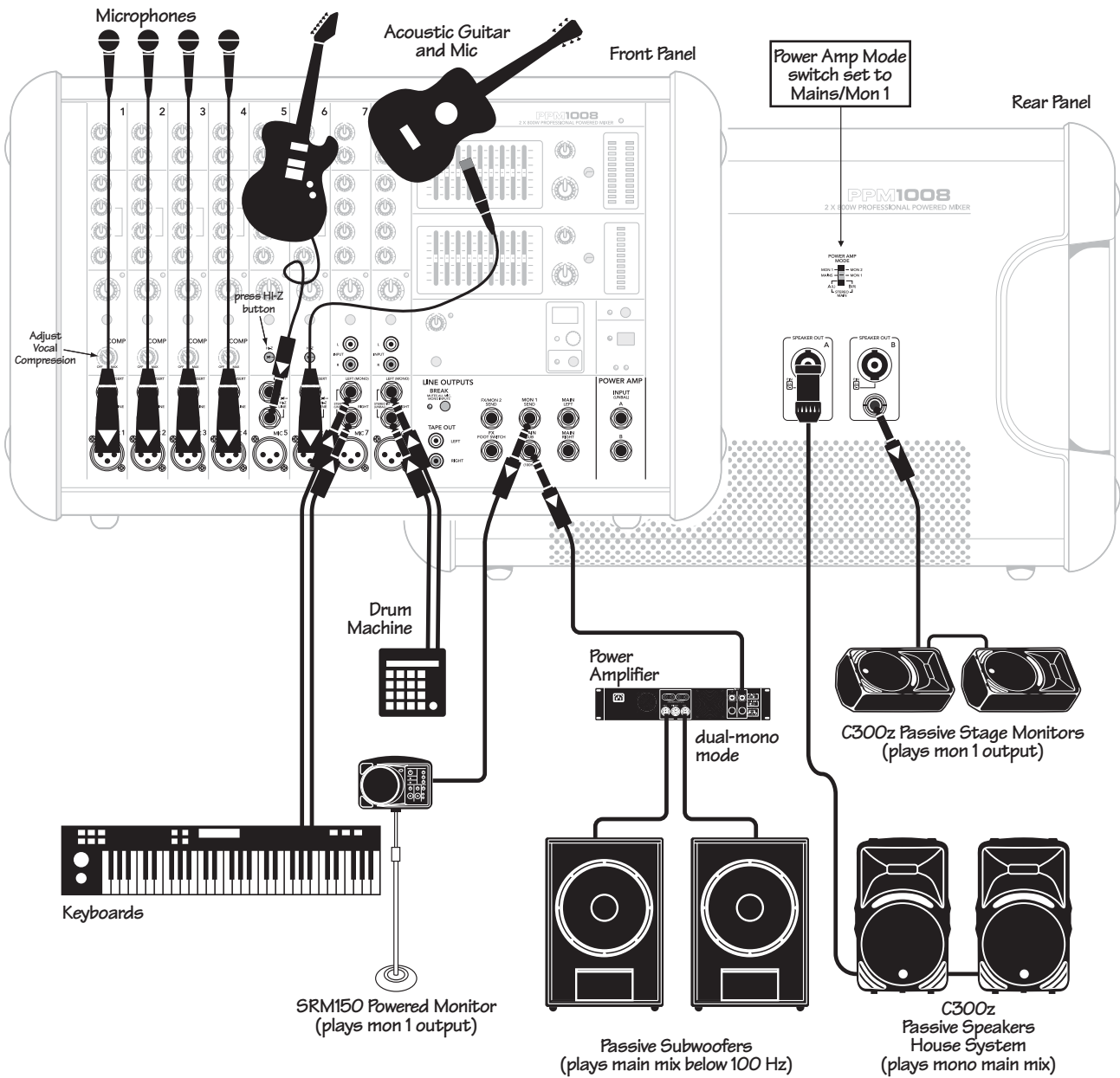

This diagram shows microphones attached to the mic inputs of channels 1 to 4, an electric guitar connected directly to channel 5 (with hi-z switch pressed in), an acoustic guitar mic connected to channel 6 mic in, a keyboard attached to channel 7's stereo inputs, and a drum machine to channel 8.

A Mackie SRM150 powered monitor is connected to the monitor 1 send, and acts as a personal stage monitor to the keyboard player. The mon 1 knobs of each channel allow you to set up a monitor mix that is independent of the main mix.

The power amp mode switch is set to play the mono main mix on ch. A, and monitor 1 mix on ch. B.

C300z passive speakers are connected to the channel A speaker-level power output of the powered mixer, and they play the main mono mix to your audience.

C300z passive stage monitors are connected to the channel B speaker-level power output of the powered mixer. These play the stage monitor mix 1 to your performers.

Passive subwoofers are powered by an amplifier connected to the main mix sub out, to reinforce the low end in your main mix.

House of Worship System

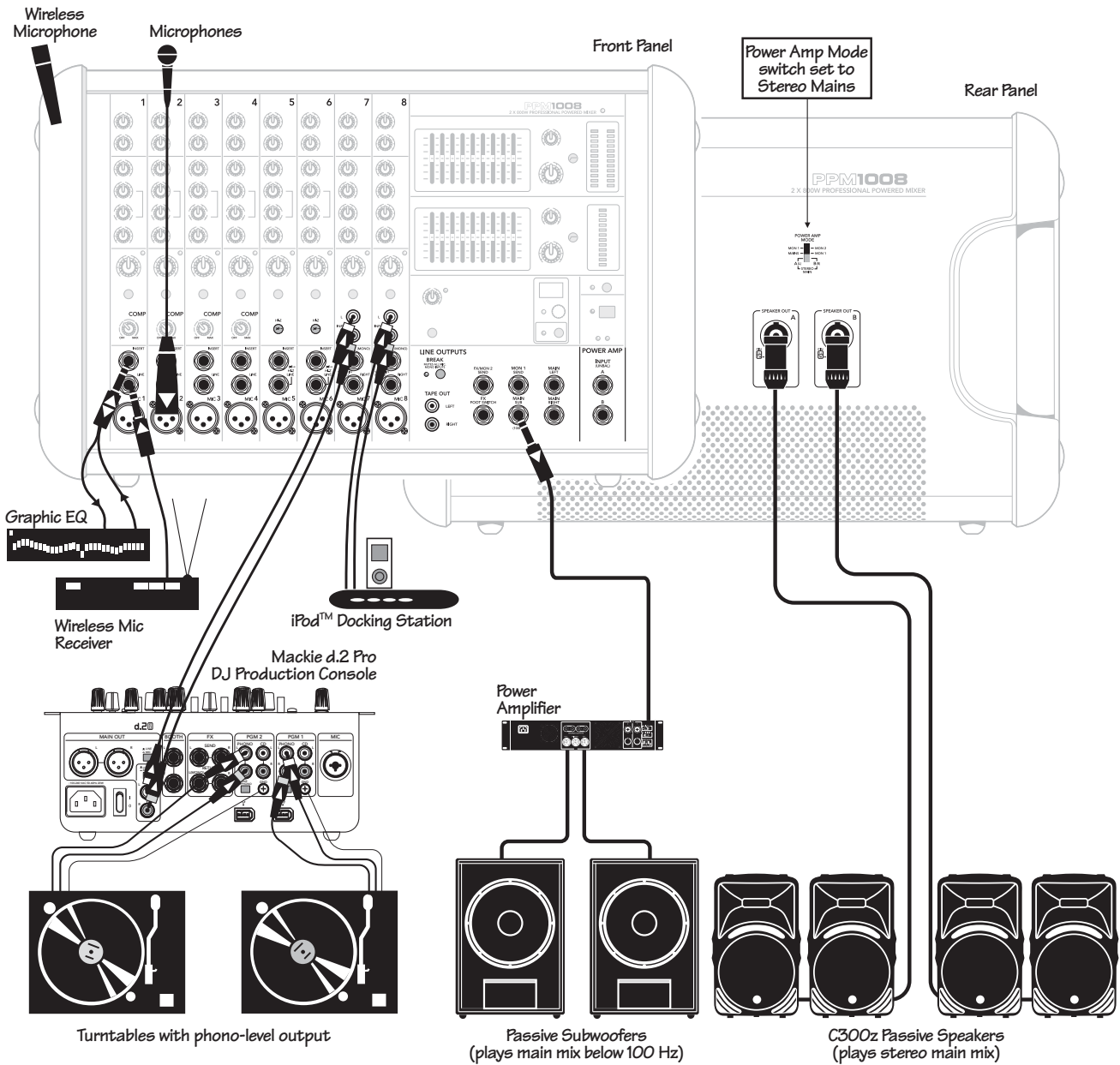

This diagram shows a wireless microphone receiver connected to the channel 1 line input, a graphic EQ connected to channel 1's insert jack (to help control feedback in the wireless mic), a microphone connected to channel 2, and an iPod docking station attached to channel 8's RCA inputs.

A Mackie d.2 Pro DJ production console is connected to two turntables, and its RCA output connects to the powered mixer's channel 7 stereo RCA inputs. Use the d.2 Pro's advanced DJ controls to get the best performance from your records. Use the powered mixer to play the d.2 Pro output, and control the mics and iPod.

The power amp mode switch is set to play the stereo main mix in the C300z passive speakers, connected to the speaker-level power outputs.

Passive subwoofers are powered by an amplifier connected to the main mix sub out, to reinforce the low end in your main mix.

DJ System

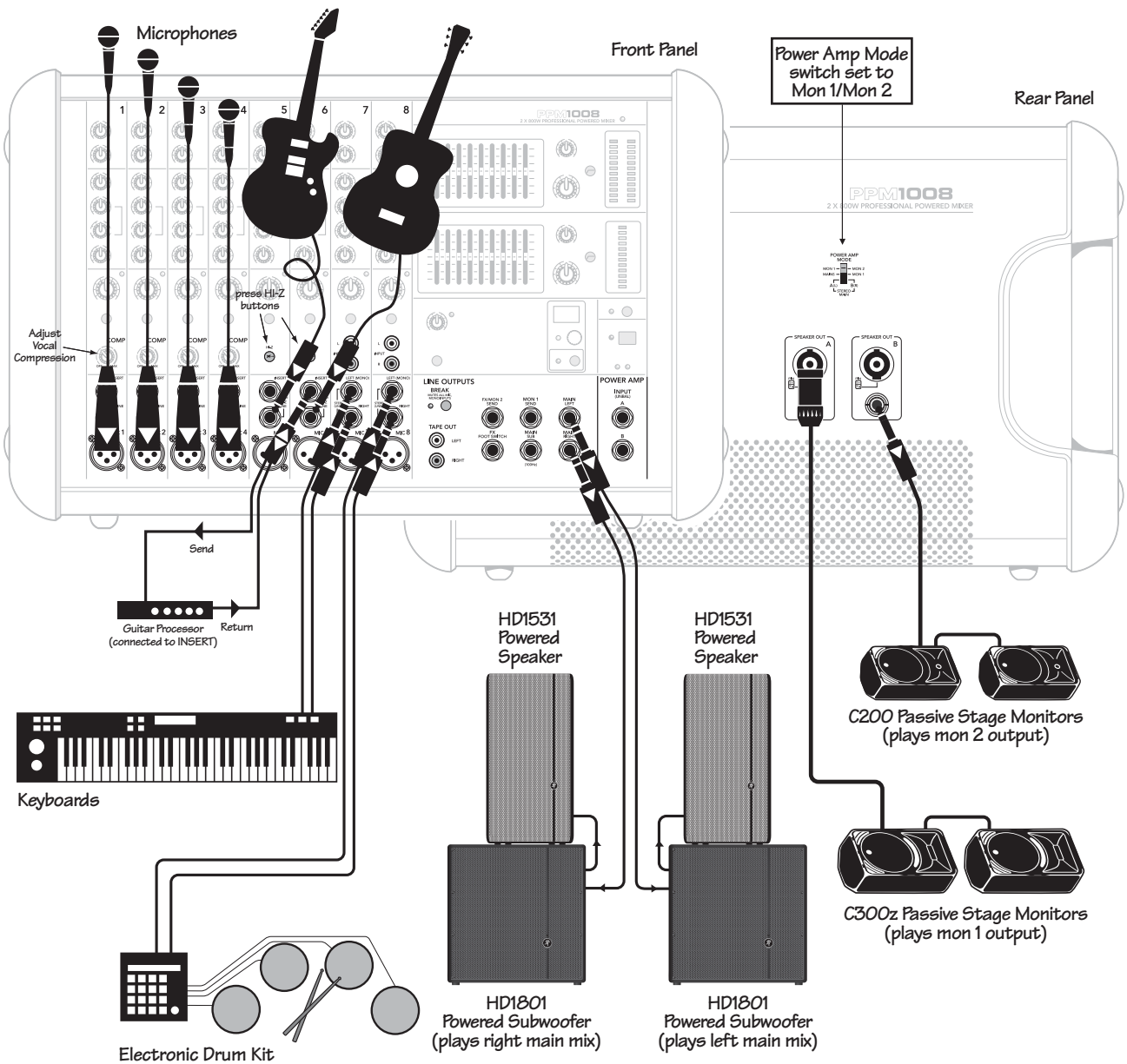

This diagram shows microphones attached to the mic inputs of channels 1 to 4, electric guitars connected directly to ch. 5 and 6 (with hi-z switches pressed in), a guitar processor connected to ch.6 insert, a keyboard attached to channel 7's stereo inputs, and an electronic drum kit attached to channel 8. Add vocal compression as required, by tweaking the compression knobs on channels 1 to 4.

The power amp mode switch is set to play the monitor 1 mix on channel A, and monitor 2 mix on channel B. Note: Press in the front panel FX send/mon 2 send switch, or monitor 2 will not play.

C200 passive stage monitors are connected to the channel B speaker-level power output of the powered mixer. These play the stage monitor mix 2 to your performers. C300z passive stage monitors are connected to the channel A speaker-level power output, and play stage monitor mix 1.

Mackie HD1531 powered speakers and HD1801 powered subwoofers are connected to the line-level main mix outputs, and play the stereo main mix to your audience.

Large Band System

Rear Panel Features

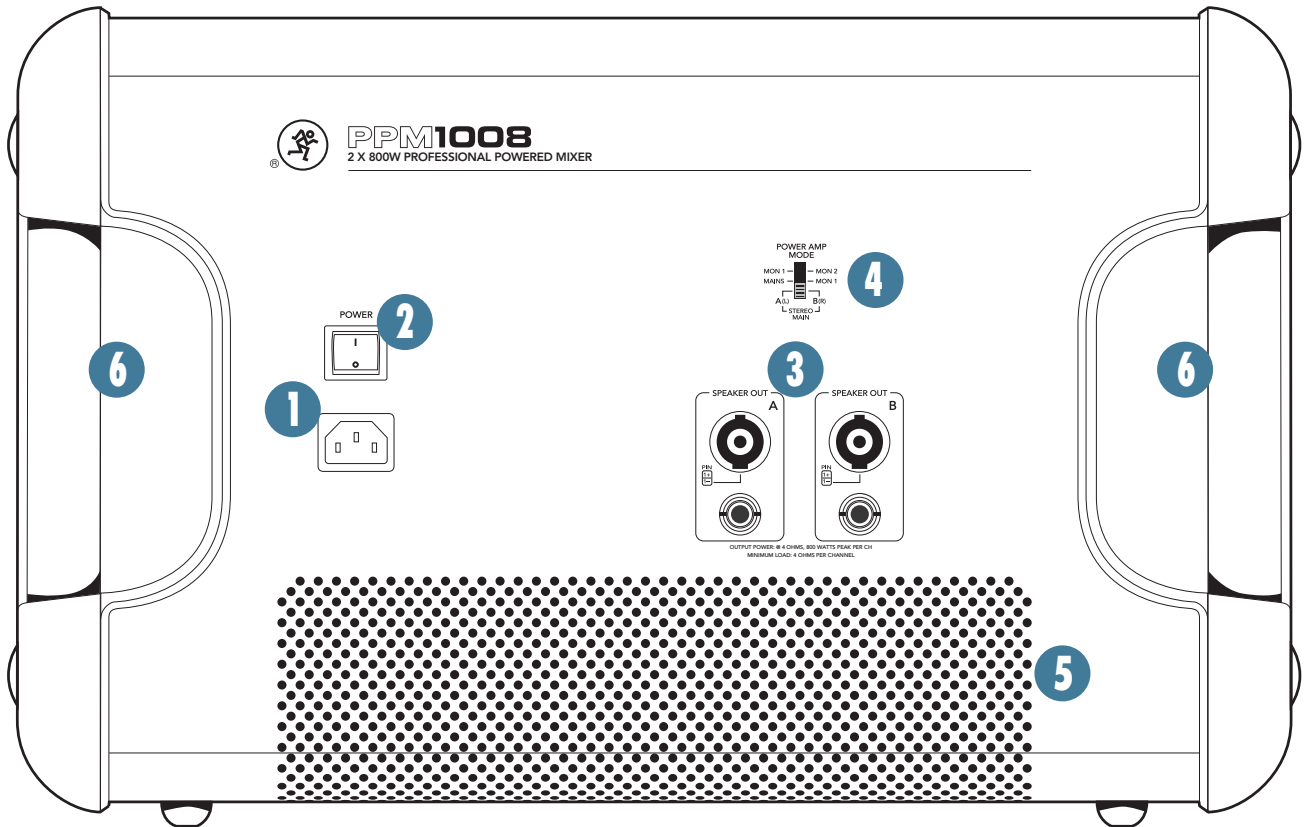

1. POWER CONNECTION

This jack accepts the supplied 3-prong IEC AC power cord.



Before you plug the AC power cord into the powered mixer, make sure that the voltage of your unit is the same voltage as your local AC mains supply. Use only the power cord supplied. Also, disconnecting the plug's ground pin is dangerous. Please don't do it.

2. POWER SWITCH

Press the top of this rocker switch inwards to turn on the mixer. The front panel power LED [35] will glow with happiness, or at least it will if you have the mixer plugged into a suitable live AC mains supply.

Press the bottom of this switch to turn off the mixer, whenever you feel that this would be a safe thing to do. Half-way through a heavy metal guitar solo might not be such a good time.



As a general guide, you should turn on your mixer first, before any external power amplifiers or powered speakers, and turn it off last. This will reduce the possibilities of any turn-on, or turn-off thumps in your speakers.

3. SPEAKER-LEVEL OUTPUTS

These output connections provide speaker-level output power from the internal power amplifiers to your passive speakers. The power output of the PPM1008 is 500 watts rms per channel into 4 ohms.



Only passive loudspeakers should be connected to these speaker-level outputs.

The outputs can be selected with the amp mode switch [4] to be either the stereo main mix, mono main mix/monitor 1, or monitor 1/monitor 2.

Two common types of connector are provided for your convenience: Speakons and 1/4" TS.

Mono Speakon Connection

- Speakon outputs are wired Pin 1+ positive (hot) and Pin 1- negative (cold).

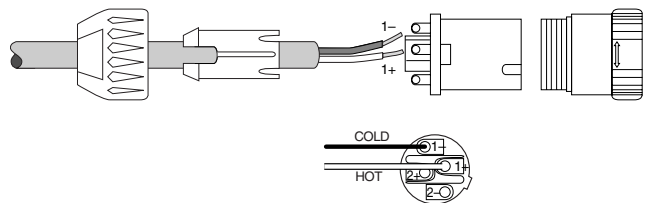

1/4" TS Connection

- 1/4" TS outputs are wired Tip positive, and Sleeve negative.

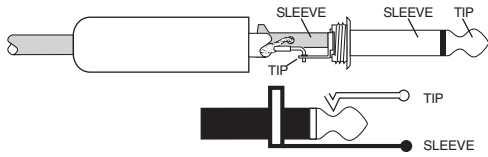

These two types of outputs are wired in parallel, and it is possible to use both types at once.



The minimum impedance that the powered mixers can handle is 4 ohms per channel, and we recommend that you do not go below this.

If you are using both outputs per channel, make sure each loudspeaker is 8 ohms impedance or greater.



Do not connect or disconnect cables to the speaker-level outputs when the mixer is powered on.

4. POWER AMP MODE SWITCH

This three-position switch lets you choose which signal paths from the mixer section are sent to the internal power amplifiers. This allows considerable flexibility in the use of the powered mixer. For example, if you already have powered main loudspeakers, you could use the PPM1008 power amplifiers to run passive stage monitors.

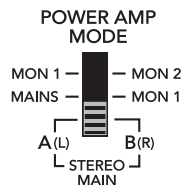

Do not change the position of the power amp mode switch when the mixer is powered on.

Stereo Mains

The output from channel A is the left side of the main mix, and the output from channel B is the right side of the main mix. Choose this position to play a straight stereo show.

Mains/Monitor 1

Channel A is the mono main mix, and channel B is the monitor 1 mix. In this setup, you could run a mono PA system on one channel, and a passive stage monitor system on the other.

Monitor 1/Monitor 2

Channel A is the monitor 1 mix, and channel B is the monitor 2 mix. In this setup, the internal power amplifiers are powering two independent passive stage monitor systems.



Make sure that the front panel FX send/mon 2 send switch [51] is pressed in (mon 2), or there will be no monitor 2 signal to the internal power amplifier channel B.



If anything is plugged into the front panel power amp inputs [20], then this switch has no effect. The internal power amplifier will play whatever signals are coming into the power amp inputs.

5. VENTILATION and REAR PANEL

Ventilation holes in the rear panel and the bottom panel allow the internal fans to flow breezy and minty-fresh cooling air over the internal power amplifiers. Do not obstruct these holes, or the amplifiers may overheat and shut down.



Do not remove the feet, as these keep the powered mixer off the ground for ventilation. Do not place the powered mixer on a carpeted or similar soft and fuzzy surface that may obstruct the ventilation holes in the bottom panel.

6. HANDLES

These metal handles are delightfully modern in styling and good looks, and truly represent the perfect accessory to accent your busy work schedule. Use the handles to carefully lift and move the powered mixer. Better yet, have someone else lift it for you. They will be remarkably pleased with its light weight, and high power, ideal for all sorts of road trips.

Front Panel Features

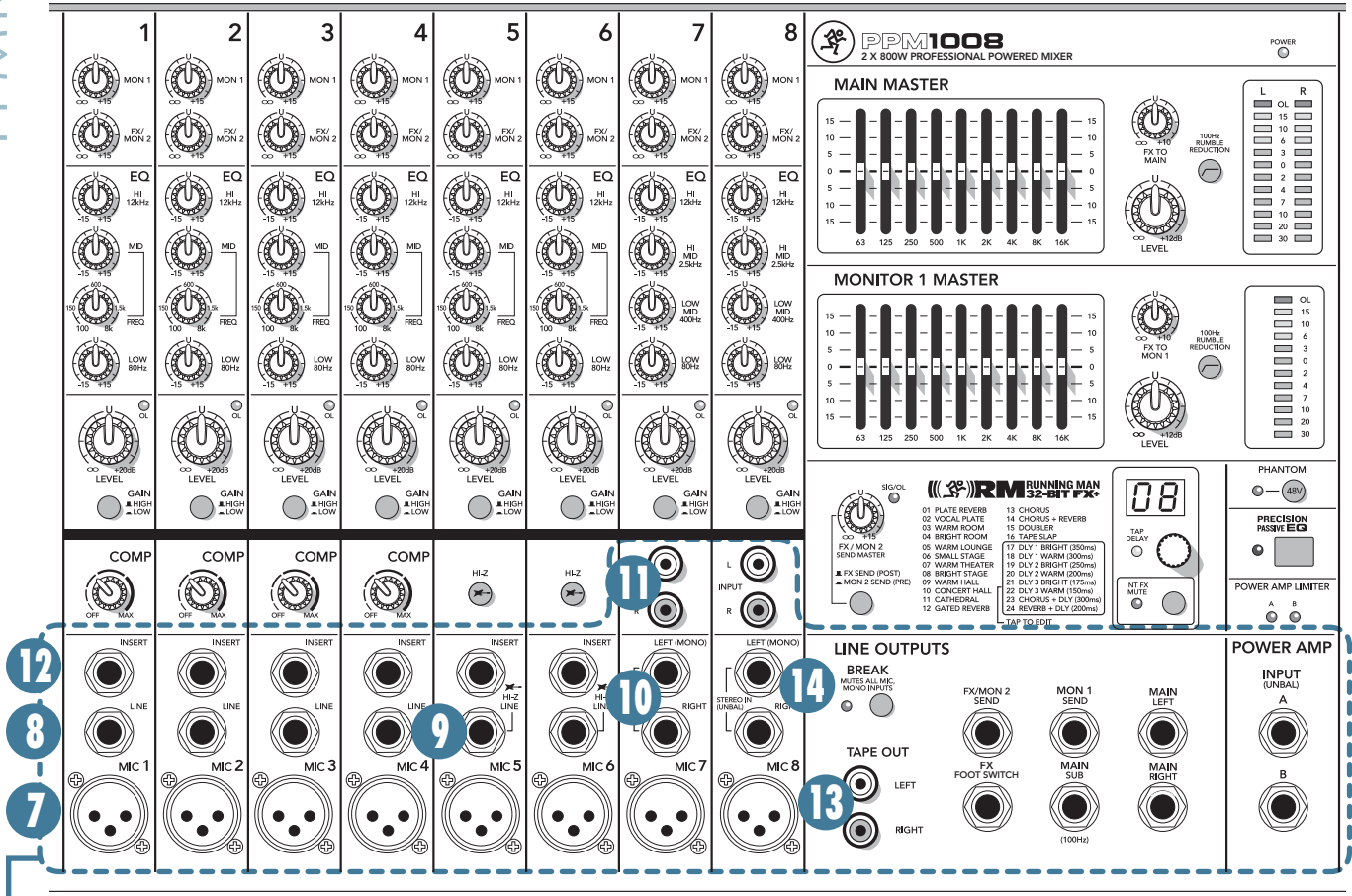

Patchbay section

This is where you plug in things such as: microphones, line-level instruments, guitars, and effects, a recorder, PA system, powered monitors, powered subwoofer etc. (The speaker-level outputs from the internal power amplifiers are on the rear panel.) Check out the hookup diagrams for some connection ideas. See Appendix B (page 25) for further details and some rather lovely drawings of the connectors you can use with your mixer.

7. MIC INPUTS

We use phantom-powered, balanced microphone inputs just like the big studio mega-consoles, for exactly the same reason: This kind of circuit is excellent at rejecting hum and noise. You can plug in almost any kind of mic that has a standard XLR-type male mic connector.

Professional ribbon, dynamic, and condenser mics all sound excellent through these inputs. The mic inputs will handle any kind of mic level you can toss at them, without overloading.

Channels 1 to 4 have the extra benefit of built-in signal in-line compressors [33]. These may be adjusted to add just the right amount of compression to your vocals and help prevent distortion and the effects of tonsillitis.

The mic inputs may employ high or low gain based upon the setting of the switch [32]. Please review the gain switch settings on page 18 for more information.

PHANTOM POWER

Most modern professional condenser mics are equipped for phantom power, which lets the mixer send low-current DC voltage to the mic's electronics through the same wires that carry audio. (Semi-pro condenser mics often have batteries to accomplish the same thing.) "Phantom" owes its name to an ability to be "unseen" by dynamic mics (Shure SM57/SM58, for instance), which don't need external power and aren't affected by it anyway.

The mixer's phantom power is globally controlled by the phantom [46] switch on the front panel. (The phantom power for all channels is turned on and off together.)



Never plug single-ended (unbalanced) microphones, or ribbon mics into the mic input jacks if phantom power is on.



Do not plug instrument outputs into the mic XLR input jacks with phantom power on, unless you know for certain it is safe to do so.

8. MONO LINE INPUTS (CH. 1 to 4)

These 1/4" jacks share circuitry (but not phantom power) with the mic preamps, and can be driven by balanced or unbalanced sources.

To connect balanced lines to these inputs, use a 1/4" Tip-Ring-Sleeve (TRS) plug.

To connect unbalanced lines to these inputs, use a 1/4" mono (TS) phone plug or instrument cable.

The mono line inputs may employ high or low gain based upon the setting of the switch [32]. Please review the gain switch settings on page 18 for more information.

9. LINE/INSTRUMENT INPUTS (CH. 5 and 6)

The line-level inputs for channels 5 and 6 can also accept instrument-level signals if the hi-z switches [34] are pressed in. This allows you to connect guitars directly to channels 5 and 6, without the need for a DI box. The input impedance is optimized for direct connection, and high-frequency fidelity is assured.

The line/instrument inputs may employ high or low gain based upon the setting of the switch [32]. Please review the gain switch settings on page 18 for more information.

10. STEREO LINE INPUTS (CH. 7 and 8)

Channel 7 and 8 have stereo line inputs. If you just have a mono source, plug it into the left input of channel 7 or 8 (labeled left/mono), and the signal will appear (as if by magic) equally on the left and right of the main mix.

The stereo line inputs may employ high or low gain based upon the setting of the switch [32]. Please review the gain switch settings on page 18 for more information.

11. RCA INPUTS (CH. 7 and 8)

Channel 7 and 8 also have RCA line inputs, suitable for connecting the line-level, unbalanced output from CD players, tape decks, iPod docks etc. They are not suitable for direct connection of phono-level outputs from turntables, as a phono preamp is required.

12. INSERT (CH. 1 to 6)

These unbalanced 1/4" jacks on channels 1 to 6 are for connecting serial effects processors such as compressors, equalizers, de-essers, or filters. The insert point is after the gain switch [32] and compressor circuits (on channels 1 – 4), but before the channel's EQ and level [31] controls. The channel signal can go out of the insert jack to an external device, be processed (or whatever) and come back in on the same insert jack. To do this requires a special insert cable that must be wired thusly:

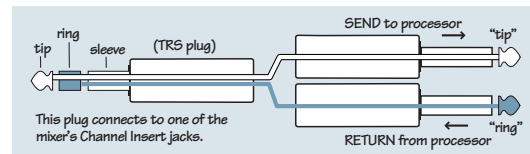

Tip = send (output to effects device)

Ring = return (input from effects device)

Sleeve = common ground

Insert jacks can be used as channel direct outputs; post-gain, and pre-EQ. See the connector section on page 26 (figure F) showing three ways to use insert connections.

13. TAPE OUTPUTS

These stereo unbalanced RCA outputs allow you to record the main stereo mix onto a tape deck, hard disk recorder, automatic CD burner, or a computer, for example. This allows you to make a recording for posterity/archive/legal purposes whenever the band gets back together again.

The tape output is the stereo main mix, not affected by the main level [38], or the main graphic EQ [36].

14. BREAK SWITCH and LED

This important "take-a-break" switch quickly mutes all the microphones and the mono channel line-level inputs when the band is between sets. This will prevent protestors or rogue karaoke singers from storming the stage at the interval. The monitor 1 and FX/monitor 2 outputs, and the drive signal to the internal effects are also muted. The LED will come on, as a reminder that the break switch is engaged. Check this LED first, if you are having trouble with no sound in your system.

You can still play the stereo channel line inputs [10] and RCA inputs [11] in the main stereo mix. For example, you could play a soothing CD to restore order before the police arrive.

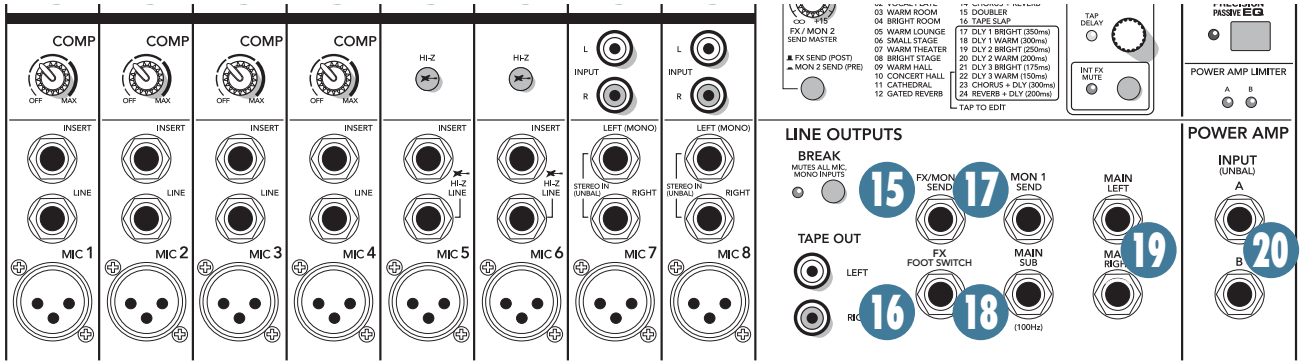

15. FX/MON 2 SEND OUTPUT

This 1/4" TRS line-level output can be used to feed an external effects processor (FX) or another set of stage monitors (mon 2). The output here is a copy of what goes into the internal FX processor, being the careful mix of all channels whose FX/mon 2 control [22] is turned more than minimum.

A CLOSER LOOK The processed output of the internal FX does not come out of here, but is added internally to the main mix or monitor 1 mix.

The overall output level can be adjusted with the FX/mon 2 send control [49], and it can be either post or pre channel level, depending on the setting of the FX send / mon 2 send switch [51] as follows:

MONITOR 2 SEND or FX SEND?

To run one set of stage monitors, use the monitor 1 system because it has its own graphic EQ [41], master level [43], and meter [45]. To run another set of monitors, set the FX send/mon 2 send switch to mon 2.

Stage monitors allow the talented musicians in your band to hear themselves clearly on stage, and this can often be a good thing. The monitor output can be carefully adjusted in level using the channel FX/mon 2 controls [22], and not change if the channel levels or main mix levels are adjusted. This is known as "pre-fader."

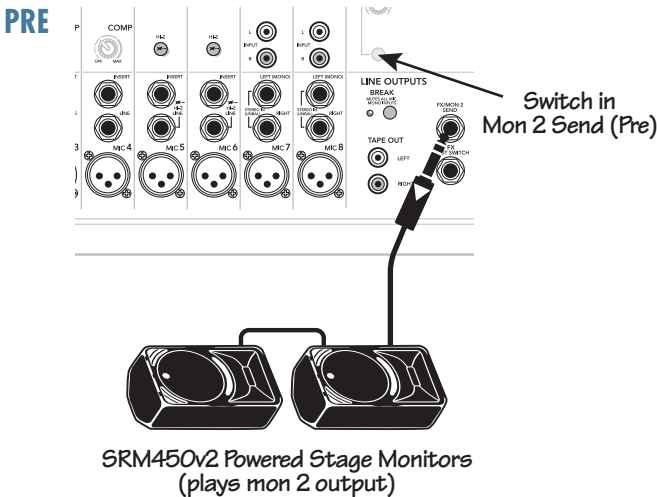

Using the output to feed a pair of powered stage monitors.

If they want "more me, and less Keith," you can turn up their channel's FX/mon 2 control, and turn down Keith's. (If you were using monitor 1 to feed the stage monitor, then you would adjust the mon 1 control [21] on each channel.)

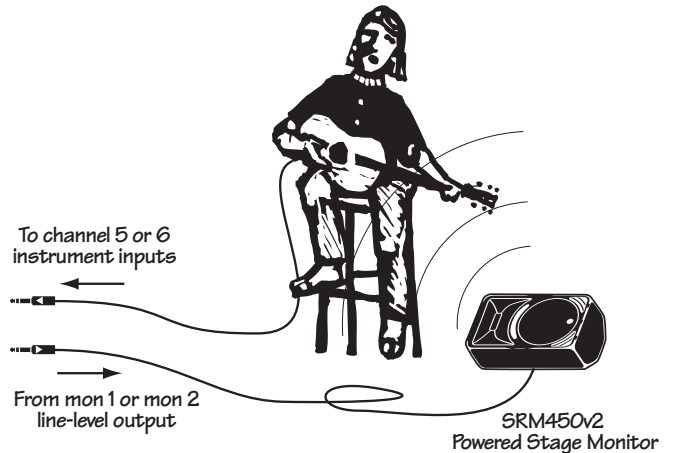

To feed an external effects processor, such as a nice sound effect, or delay, the feed should be "post-fader." In this way, any changes to the channel level will also affect the level going to the external processor. The processed output from the effects processor is usually returned to a spare channel, and you can carefully mix the original unprocessed channel (dry) and the processed channel (wet). Altering the original channel level increases both the wet and dry signals and keeps them at the same delicate ratio. (For example, the reverb remains at the same level relative to the original).

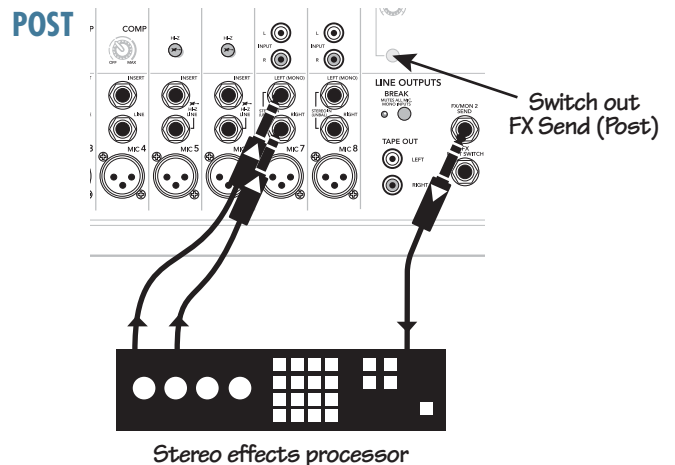

Using the output to feed a stereo effects processor. In this example, the stereo outputs go to ch. 7 stereo inputs.

EFFECTS: SERIAL OR PARALLEL?



“Serial” means that the entire channel signal leaves the mixer (insert [12] send), is routed through the effects device, and returns to the mixer (insert return). Examples: compressor, limiter, graphic equalizer. Line-level sources can also be patched through a serial effects device before connection to the mixer.

“Parallel” means that a portion of the signal in the mixer is tapped off to the device, processed, and returned to a spare channel of the mixer to be mixed with the original “dry” signal. This way, multiple channels can all make use of the same effects device. Examples: reverb, digital delay. The internal effects are parallel, as all channels can make use of it, and the processed output is added to the main mix.

16. FX FOOTSWITCH

This 1/4" TRS connector is where you can connect a footswitch. This will allow you to easily mute or un-mute the internal effects, while stamping your foot and looking like you were mad about something. Any one-button on/off footswitch will work.

If the internal effects have already been muted with the front panel mute switch [54] then the footswitch has no effect, but you can still stamp your foot and pout if that helps any. Cultivate that bad-boy image.

17. MON 1 SEND

This 1/4" TRS connector allows you to send the monitor 1 line-level output to stage monitors. These could either be passive stage monitors powered by an external amplifier, or powered stage monitors with their own amplifier built in.

The monitor signal is the sum (mix) of all the channels whose mon 1 control [21] is set to more than minimum. The overall output level can be adjusted with the mon 1 master level [43] and its EQ tweaked with the monitor graphic EQ [41].

The monitor 1 output is not affected by the main master level [38], or the channel level controls [31]. This allows you to set up the monitor mix and level just right, and not have it change every time a channel level or the main mix level is adjusted. This is the main aim of a monitor mix: independence from the main mix.

18. MAIN SUB

This 1/4" TRS connector supplies a copy of the mono main mix below 100 Hz. This is usually patched to the inputs of an external power amplifier running a passive subwoofer, or directly to a powered subwoofer. Whatever adjustments you make to the main mix, will affect this output below 100 Hz.

(The main mix still plays the full frequency range, this sub output is just a copy of the range below 100 Hz for external subwoofers.)

19. MAIN OUTPUTS

These 1/4" TRS outputs supply the stereo main mix at line-level. You can connect these outputs to the line-level inputs of external power amplifiers running passive loudspeakers, or to the inputs of powered loudspeakers (or not use them at all, if you don't have the external gear).

These outputs play the same signal as the rear-panel speaker-level outputs [3] (when set to stereo mains), only at line-level.

These outputs can also be used to feed an external stereo effects processor or other device, and have the processed output of that device feed the power amp inputs [20]. This places the device in-line and it will affect the main mix.



Another super idea is to use an external active crossover. This splits the line-level main output into two or three frequency bands. The high-frequency output of the crossover could be connected to the power amp inputs [20], so the internal amplifiers will power your top-frequency-range loudspeakers. The active crossover's low-frequency outputs could connect directly to powered subwoofers. In this way, you can take some of the strain off your powered mixer's internal amplifiers, and have the powered subwoofers crank out the bass.

20. POWER AMP INPUTS

These unbalanced 1/4" TS inputs allow you to connect line-level signals directly to the input of the internal power amplifiers.

The amplifiers will only play what you put in, and only the precision passive EQ switch [47] and limiters [48] will affect the output. The power amp mode switch [4] has no effect, and the meters will not show the levels. Plugging anything in here, does not affect any of the line-level outputs.

You could patch a device between the main outputs [19] and these inputs, in which case, the controls and meters will work except for the power amp mode switch.

These inputs are also useful when you need more channels than the PPM1008 provides. You could connect the line-level outputs from another mixer, and use it to control the mix and levels playing in loudspeakers attached to the powered mixer.



The external mixer or device will control the volume, so turn it down at first, or the powered mixer may come on at full volume.

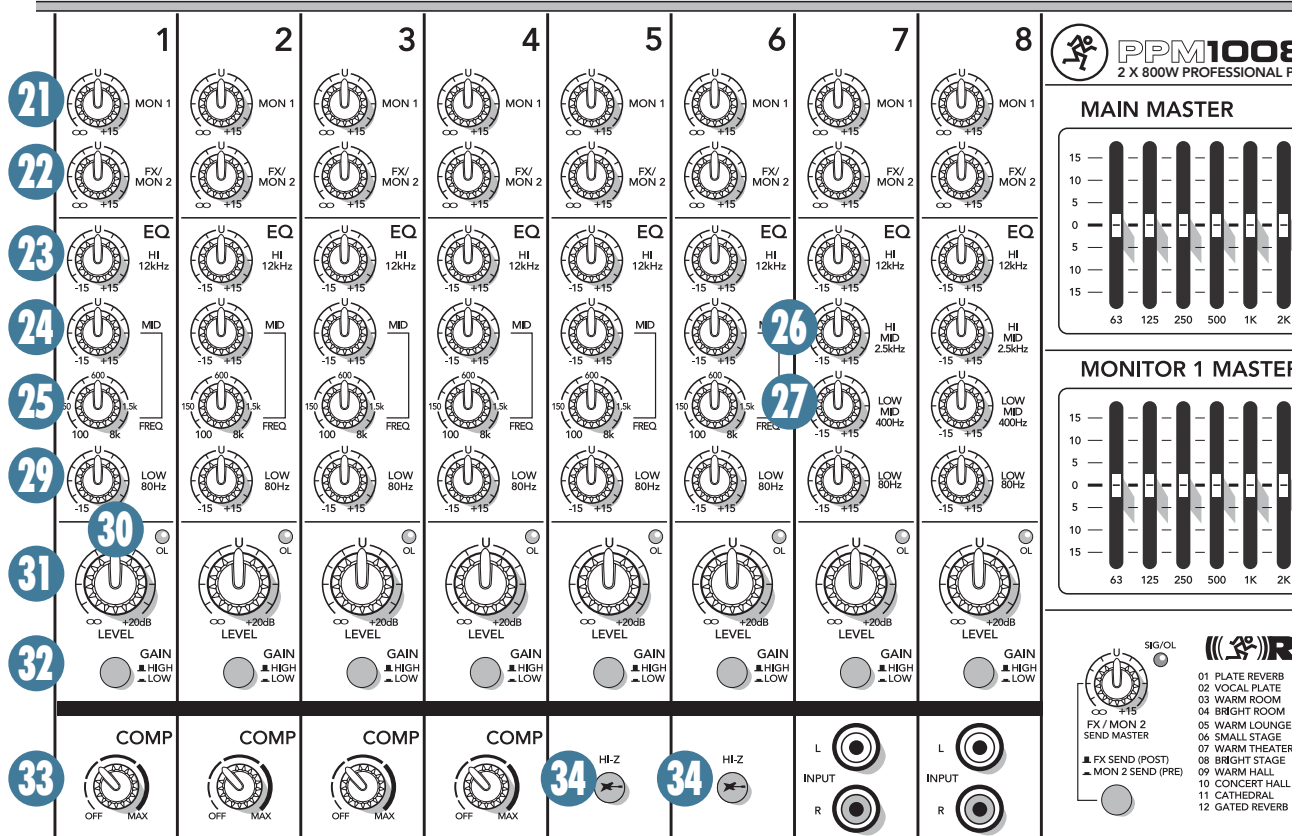

Channel Controls

The eight vertical channel strips look very similar, with only a few differences between them. Each channel works independently, and just controls the signals plugged into the inputs directly below it.

Mono Channels 1 to 6

- Channels 1 to 6 are mono channels, and their controls affect either the mono mic input or the mono line-level input.
- Channels 1 to 4 have a built-in signal in-line-compressor circuit with adjustable threshold.
- Channels 5 and 6 have a hi-z switch [34] so you can connect guitars directly.
- The mono 3-band EQ has shelving high, low, and peaking mid EQ with sweepable frequency.
- The mono signals are split equally to the left and right of the main mix.

Stereo Channels 7 to 8

- Channels 7 and 8 are stereo channels, and their controls affect either the mono mic input, stereo line-level input, or stereo RCA inputs. (The mono mic input of each stereo channel is split equally to left and right).
- The stereo channel 4-band EQ has shelving high, shelving low, peaking lo-mid, and hi-mid.

“U” like Unity gain

Mackie mixers have a “U” symbol on almost every level control. It stands for “unity gain,” meaning no change in signal level. The labels on the controls are measured in decibels (dB), so you’ll know what you’re doing level-wise if you choose to change a control setting.

Signal Flow

The block diagram on page 29 shows the signal flow, but here is a short description of the flow through the channel strip section:

The mic inputs and mono line inputs each feed a preamplifier whose gain is set by the gain switch [32]. The stereo channel line inputs and RCA inputs do not go through a gain-selectable preamp.

The signal then passes through the compressor circuit (ch. 1 to 4 only), then through the channel EQ, and the channel level [31].

The mon 1 control [21] taps the signal off just before (pre) the channel level.

The FX/mon 2 control [22] taps the signal off before (pre) and after (post) the channel level. The FX send/mon 2 send switch [51] lets you choose which is used. Post is used for FX, and pre is for monitor 2.

21. MON 1

This control allows you set up a nice monitor mix, independent of the main mix or the monitor 2 mix. Adjust these controls on each channel until your band is happy with the stage monitor mix. The controls are off when turned fully down, deliver unity gain at the center detent, and can provide up to 15 dB of gain turned fully up. Adjustments to the channel level or main mix level will not affect the monitor output, but channel EQ and gain [32] will.

One of the powered mixer's internal amplifiers can power passive stage monitors if you set the power amp mode switch [4] on the rear panel. Mon 1 send [17] is a line-level output if you want to connect external power amplifiers and passive stage monitors, or powered stage monitors.

22. FX/MON 2

These controls allow you to send a sample of each channel's signal to the internal FX processor, and to the FX/mon 2 line-level output [15] to run external processors, or a second set of stage monitors.

Carefully adjust each control to set up the FX or monitor 2 mix. The controls are off when turned fully down, deliver unity gain at the center detent, and can provide up to 15 dB of gain turned fully up.

The dual nature of this knob (FX or mon 2) is determined by the setting of the FX send /mon 2 send switch [51]. More FX/mon 2 details are shown on page 14 and page 23 (item 51).

CHANNEL EQUALIZATION (EQ)

The PPM1008 mono channels have 3-band equalization: low shelving, mid peaking with adjustable frequency, and high shelving. The stereo channels have 4-band EQ: low shelving, low-mid and high-mid peaking, and high shelving. It's probably all the EQ you'll ever need!

Shelving means that the circuitry boosts or cuts all frequencies past the specified frequency. For example, the low EQ boosts bass frequencies below 80 Hz and continues down to the lowest note you never heard. Peaking means that certain frequencies form a "hill" around the center frequency.



With too much EQ, you can really upset things. We've designed a lot of boost and cut into each equalizer circuit because we know that everyone will occasionally need that. But if you max the EQ on every channel, you'll get mix mush. Equalize subtly and use the left sides of the knobs (cut), as well as the right (boost). If you find yourself repeatedly using full boost or cut, consider altering the sound source, such as placing a mic differently, trying a different kind of mic, changing the strings, or gargling.

23. HIGH EQ

The high EQ provides up to 15 dB of boost or cut above 12 kHz, and it is also flat at the detent. Use it to add sizzle to cymbals, an overall sense of transparency, or an edge to keyboards, vocals, guitar and bacon frying. Turn it down a little to reduce sibilance or to mask tape hiss.

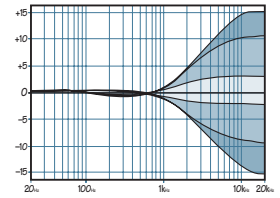

24. MID EQ LEVEL (Ch. 1 to 6)

The mid knob sets the amount of boost or cut, up to 15 dB, and is effectively bypassed at the center detent. The frequency at which the cut or boost occurs is set by the frequency control [25].

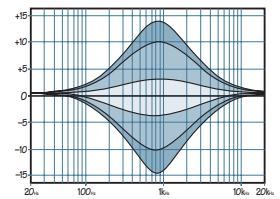

25. MID EQ FREQUENCY (Ch. 1 to 6)

This knob sets the center frequency of the mid EQ control [24]. This is sweepable from 100 Hz to 8 kHz.

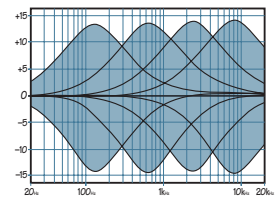

Once this is set, the mid EQ level can be adjusted with the mid EQ level control [24].

Most of the root and lower harmonics that define a sound are located in the 100 Hz–8 kHz frequency range, and you can create drastic changes with these two knobs. Many engineers use mid EQ to cut midrange frequencies, not boost them. One popular trick is to set the mid fully up, turn the frequency knob until you find a point where it sounds just terrible, then back the mid down into the cut range, causing those terrible frequencies to disappear. Sounds silly, but it works. Sometimes.

26. HIGH MID EQ LEVEL (Ch. 7 and 8)

The high mid EQ provides up to 15 dB of boost or cut at 2.5 kHz, and it is also flat at the detent. This control is only available on stereo channels 7 and 8.

27. LOW MID EQ LEVEL (Ch. 7 and 8)

The low mid EQ provides up to 15 dB of boost or cut at 400 Hz, and it is also flat at the detent. This control is only available on stereo channels 7 and 8.

28. ICE CREAM DISPENSER

This control is not there. It was going to be, but after much discussion among the engineers, it was decided not to add it after all. It would have been good though.

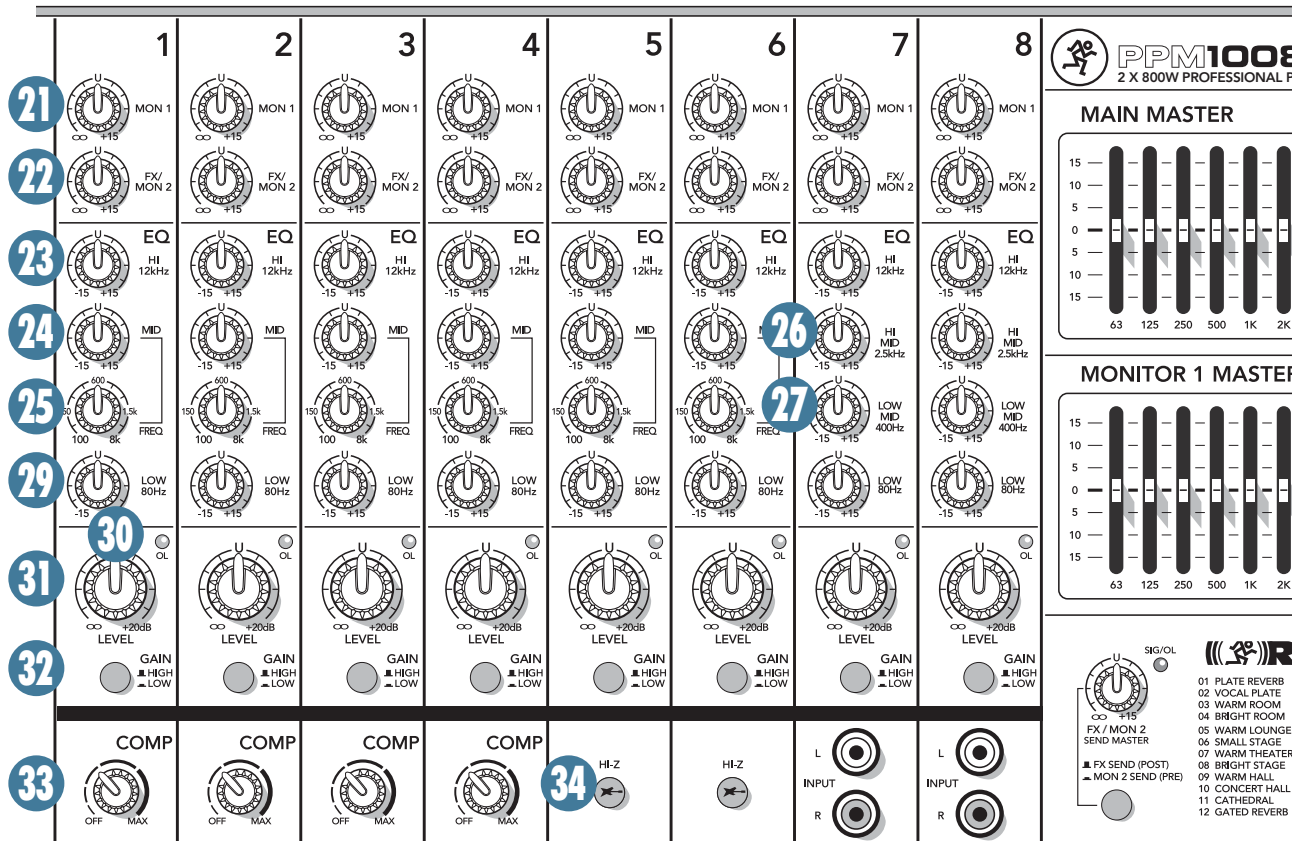

29. LOW EQ

The low EQ provides up to 15 dB of boost or cut below 80 Hz. The circuit is flat (no boost or cut) at the center detent position. This frequency represents the punch in bass drums, bass guitar, fat synth patches, and some really serious male singers who eat raw beef for breakfast.

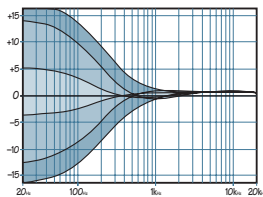

30. OVERLOAD (OL) LED

This LED will come on when the channel's input signal is too high. This should be avoided, as distortion will occur.

If the LED is coming on regularly, check that the gain switch [32] is set correctly for your input and that the channel EQ [23–29] is not set with too much boost.

31. CHANNEL LEVEL

This adjusts the level of each channel onto the main mix. The “U” mark indicates unity gain, meaning no increase or decrease of signal level. All the way up provides an additional 20 dB, should you need to boost a section of the band. If you find that the overall level is too quiet or too loud with the level near unity, you'll want to confirm the gain switch is set correctly.

32. GAIN SWITCH

Engage this switch [low] on channels that have “louder” instrumentation connected. For example, loud singing or yelling or other loud-voiced instruments, such as bass, guitar or horns (whether connected via DI or mic'd).

Disengage this switch [high] on channels that have “quieter” instrumentation connected. For example, spoken word shows, poetry readings, stand-up comedy or other quieter-voiced instruments such as a finger-picked acoustic guitar, cello, djembe, bouzouki and cats.

Gain switch position	MIC (XLR) Inputs	LINE (TRS) Inputs
IN (LOW)	Gain = 25 dB	Gain = 0 dB
OUT (HIGH)	Gain = 45 dB	Gain = 20 dB

Note that the gain switch has no effect on the line-level inputs and RCA inputs of channels 7 or 8.

This is the first control that the input signals meet. It allows you to choose the level depending on the type of input source you have connected. If it is set incorrectly, then the input signals may overload the mixer, causing distortion, or it may come in too low, and be lost in noise.

The gain switch allows you to make the initial level adjustment, appropriate for the connected device (mic or line). The channel level controls [31] are more for fine-tuning, to balance the channels appropriately for the song.

33. COMPRESSOR

Channels 1 to 4 have an in-line compressor circuit with a variable threshold. This is very useful for compression of vocals, for example.

When the incoming signals exceed the threshold level set by this knob, the signal level is automatically compressed. This reduces the dynamic range, and reduces the chance of distortion due to overloading the input signals.



Dynamic range is the difference in level between the quietest part of your song and the loudest part. Using a compressor, you are able to squeeze the dynamic range, resulting in an overall steadier, more constant volume level for the signal. It helps sources such as vocals “sit” properly in the mix, and it is very useful for live sound as well.

The compression ratio is fixed at around 6:1, with a soft knee response. The threshold can be adjusted clockwise from off (no compression) to 0 dBu (max).

As an example, suppose the threshold is set to maximum. An incoming signal reaches the threshold of 0 dBu. As it increases beyond the threshold, it becomes compressed at a ratio of 6:1. This means that even if the input further increases by 6 dB, the actual output only increases by 1 dB. This compresses the output signal, so there is more protection to your system from distortion and overload due to poor microphone technique (say it ain't so) and general pops, bangs and heavy metal screaming. The soft knee means that the compression slowly ramps up to 6:1 from the threshold. It does not jump abruptly to 6:1, as this would be hard knee compression, and hard on the ears too.



The following graph shows the input signal level going into the compressor, versus the output level coming out of it. It is the typical graph to see when compressors are discussed, and is just the kind of thing our engineers like to talk about during the company Christmas party.

If the compressor is off, then the input = output. For example an input signal level of +5 dBu results in an output level of +5 dBu. The diagonal line from lower left to upper right represents $x = y$, that is, input = output.

At the maximum compression, the threshold is set at 0 dBu, and the input to output relationship is represented by the lower blue curve. If the input is -5 dBu (that is, below the threshold), the output is -5. As the input reaches 0 dBu, the output is a bit less than 0 dBu. If the input is +5 dBu, the output is about +2 dBu. If the input reaches +10 dBu, then the output is +3 dBu. Notice the shapely curve of the soft knee between the diagonal slope of $x = y$ and the compressor slope of 6:1 (the compression ratio).

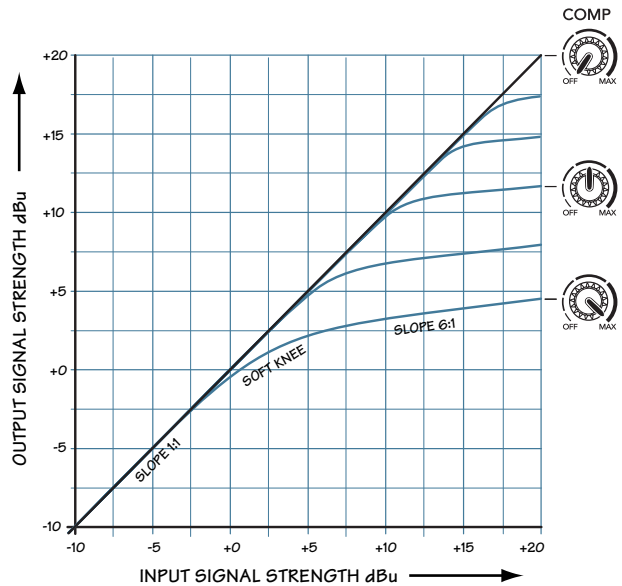

The other blue curves represent in-between positions of the compressor knob, with higher thresholds before compression begins.

Separate compressors often have controls such as compression ratio, threshold, soft knee/hard knee, attack time, and release time. These last two affect how quickly the compressor kicks in when the input exceeds the threshold, and how quickly it is released after it drops below the threshold. In this powered mixer compressor, these parameters are specially chosen to give you the best overall performance.

Adjust the threshold carefully, so your dynamic range is still lovely, without distortion or overload during the performance. Run through a few practice songs and adjust the compression as required.

34. HI-Z SWITCH



Channels 5 and 6 are the only place to plug in guitars and basses directly to the powered mixer. These switches must be pressed in first.

If you connect a line-level device, such as a keyboard or drum machine, make sure these switches are out. (They only affect the 1/4" line inputs of channels 5 or 6, not the XLR mic inputs.)

To use guitars or other instruments on other channels, you will need to use an external DI box first. Without the DI box, (or if these switches are not pressed in) guitars will sound dull and muddy.

Master Controls

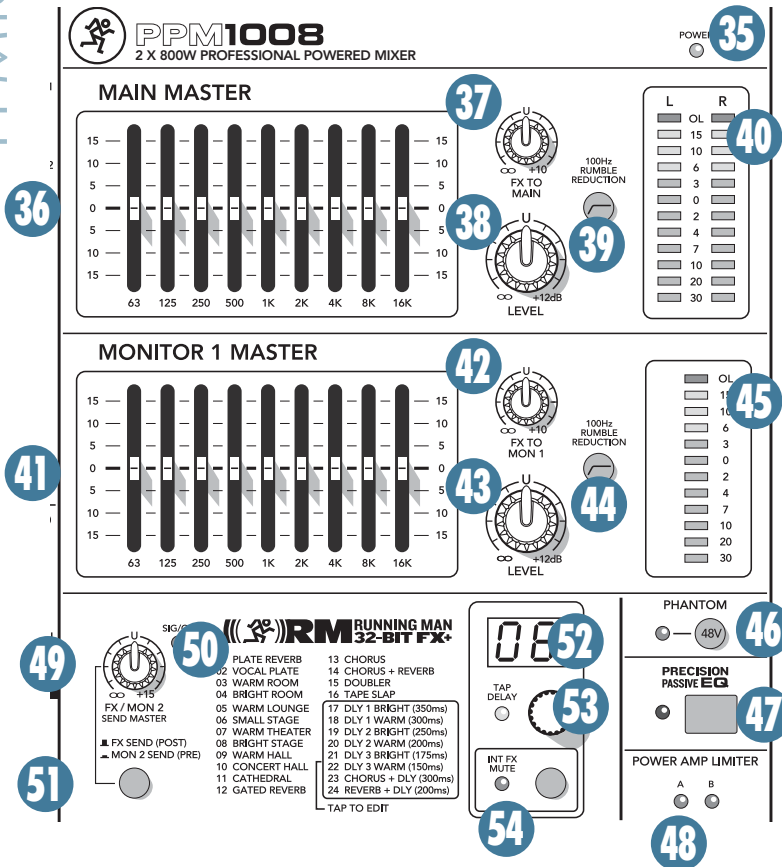

35. POWER LED

This LED comes on when the powered mixer is plugged into the correct-voltage AC mains supply, and the rear panel power switch [2] is on.

If the LED does not turn on, make sure the AC power is live, both ends of the power cord are correctly inserted, your electricity bill has been paid, and the lights in town are still on.

36. MAIN MASTER GRAPHIC EQ

This 9-band graphic equalizer adjusts the main mix output. It affects the line-level outputs [19], as well as the main speaker-level outputs if the internal amplifiers are playing the main mix.

Each slider allows you to adjust the level of its frequency band, with up to 15 dB of boost or cut, and no change in level at the center (0 dB) position. The frequency bands are: 63, 125, 250, 500, 1k, 2k, 4k, 8k and 16 kHz.

The EQ section comes after the main level [38], and just before the main meters [40]. Therefore, as you adjust the EQ, you can keep an eye on the meters in case you over-do it and take the levels into overload.

As with the channel EQ, just take it easy. There is a large amount of adjustment, and if you are not careful, you can upset the delicate balance of nature. Although it may not seem cool to turn down controls, with EQ it is often your best option. Turn down the offending frequency range, rather than boost the wanted range. Having many sliders will allow you to reduce the level of some frequency bands where feedback occurs.



With this constant-Q graphic EQ, the bandwidth (and Q) of a frequency band doesn't vary with the amount of boost or cut. The adjustment of one slider has minimal effect on adjacent bands for all settings of the slider levels. (There's always some effect on adjacent bands to avoid too much variation or ripple between bands, but the constant-Q design keeps this fairly constant for all settings.) The position of the sliders gives a good indication of the frequency response across the audio band. Non-constant types of EQ (on other mixers) give a wider bandwidth for lower levels of boost or cut, and narrows as the level goes up or down. For

example, if you're boosting 500 Hz and 2 kHz slightly, the 1 kHz band will also be boosted, even though the 1 kHz slider is in the flat position.

37. FX TO MAIN

This knob lets you adjust the level of the internal effects being added to the main mix. (It is a stereo control, as the output from the internal effects processor is stereo and is added to the left and right main mix.)

Adjust the FX level being added, compared to the other channels playing in the main mix.

At the fully-down position, no effects are added, the center U mark is unity gain, and 10 dB of effects gain is available at the fully clockwise position.

38. MAIN LEVEL

This knob controls the overall level of the main mix, and affects the main meters [40], main line-level outputs [19], main sub out [18], and the main speaker-level outputs if the internal amplifiers are playing the main mix. The level adjustment occurs before the EQ [36].

This gives you ultimate control over your audience. Adjust it carefully, with your good eye on the meters to prevent overloading, and your good ear to the levels to make sure your audience is happy.

The control does not affect the monitor 1 output [17], monitor 2 output [15], or the internal power amp if it is playing a monitor. (For stage monitor work, it is good that the main mix level does not affect the monitor outputs, so they can be set up nicely and stay that way.)

The main mix signals are off with the level fully down, the “U” marking is unity gain, and fully up provides 12 dB of additional gain. This additional gain will typically never be needed, but once again, it’s nice to know it’s there. The level control is stereo, as it affects both the left and right of the main mix equally. This is the control to turn down at the end of the song when you want “The Great Fade-Out.”

39. 100 Hz RUMBLE REDUCTION SWITCH

This switch is used to reduce the level of the frequency range below 100 Hz. It operates only on the mono channel 1 to 6 mix, not the stereo channel mix. Engage it to remove excess low-end from the mic inputs while still keeping the full-range stereo inputs full of meaty low-end.

Use this to reduce the amount of low frequency problems such as mic handling, stage rumble, bangs and thumps in your main mix.



This switch is the audio-electronic equivalent of taking anti-gas medication. It relieves low-end rumble, and the whole room sounds better.

40. MAIN MIX METERS

Developed from a harmless ex-NASA hamster hypnotizer*, these stereo meters show the level of the left and right main mix, after it has passed through the main level [38] and graphic EQ [36]. The top LEDs are marked OL (overload), and you should adjust the levels to avoid these coming on too often, if at all.

Please remember: Audio meter displays are just tools to help assure you that your levels are “in the ballpark.” You don’t have to stare at them (unless you want to).

*Tests have shown that it is possible to send hamsters safely to Mars and back under deep hypnosis.

41. MONITOR 1 MASTER GRAPHIC EQ

This 9-band, constant-Q, graphic equalizer adjusts the monitor 1 mix output. It affects the line-level monitor 1 outputs [17], and the monitor 1 speaker-level output if the internal amplifier is playing the monitor 1 mix.

Each slider allows you to adjust the level of its frequency band, with up to 15 dB of boost or cut, and no change in level at the center (0 dB) position. The frequency bands are: 63, 125, 250, 500, 1k, 2k, 4k, 8k and 16 kHz.

The EQ section comes after the monitor 1 level [43], and just before the monitor 1 meter [45]. Therefore, as you adjust the EQ, you can keep an eye on the meter in

case you over-do it and take the levels into overload. As with the channel EQ, just take it easy.

Having many sliders will help you reduce the level of frequency bands in the stage monitors that cause feedback from nearby microphones.

42. FX TO MON 1

This knob lets you adjust how much of the internal effects is added to the mono monitor 1 mix. (The output from the internal effects processor is stereo, summed to mono and added to the mono monitor 1 mix.)

Adjust the FX level being added, compared to the other channels playing in the monitor 1 mix.

At the fully-down position, no effects are added, the center U mark is unity gain, and there is 10 dB of effects gain at the fully clockwise position.

43. MONITOR 1 LEVEL

This knob controls the level of the monitor 1 mix, and affects the monitor 1 meter [45], mon 1 line-level outputs [17], and the monitor 1 speaker-level output if the internal amplifier is playing the monitor 1 mix. The level adjustment occurs before the monitor 1 EQ [41].

This gives you ultimate control over your monitor 1 stage monitors. Adjust it carefully, with your good eye on the meter [45] to check against overloading, and to make sure your band are happy with the levels. The control does not affect the main mix level.

The monitor 1 mix signals are off with the level fully down, the “U” marking is unity gain, and fully up provides 12 dB of additional gain.

44. 100 Hz RUMBLE REDUCTION SWITCH

This switch is used to reduce the level of the frequency range below 100 Hz from the monitor 1 mix. It only affects the monitor 1 mix, and does not affect any effects being added from the internal FX processor.

Use this to reduce the amount of low frequency problems such as mic handling, stage rumble, bangs and thumps that might affect the stage monitors.

Additionally, utilize this switch to reduce low frequency feedback through the monitors. This switch should almost always be engaged unless the performing artists request more low-end from the monitors.

45. MONITOR 1 METER

This meter shows you the level of the monitor 1 mix, after it has passed through the monitor 1 level [43] and graphic EQ [41].

The top LED is marked OL (overload), and you should adjust the levels to avoid this coming on too often, if at all.

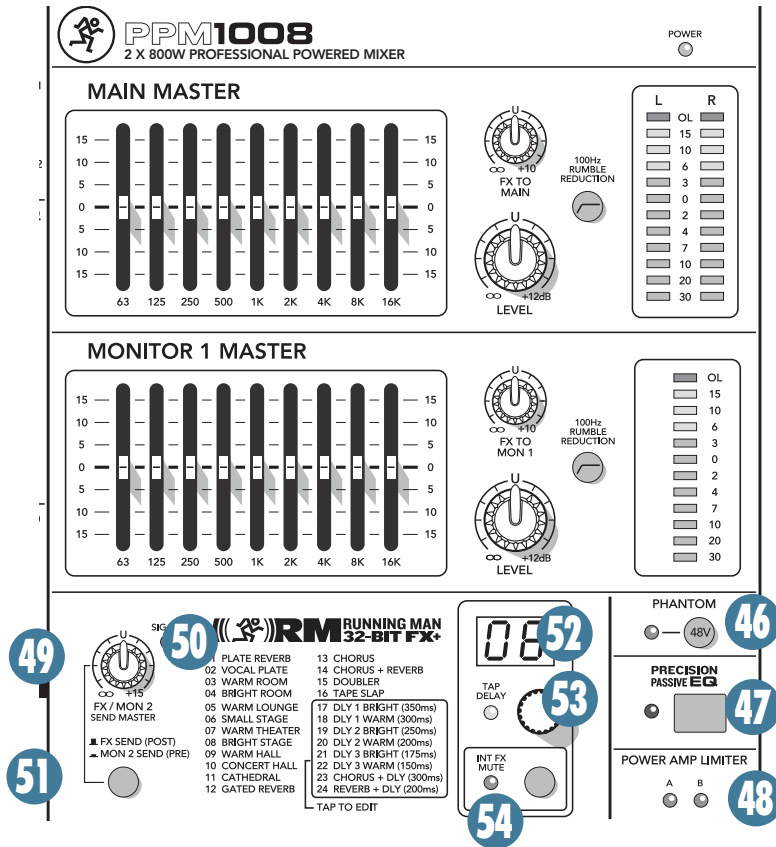

46. PHANTOM SWITCH

Press in this switch to add phantom power to all the XLR microphone inputs of the mixer. This lets the mixer send low-current DC voltage to the mic's electronics through the same wires that carry audio. The LED will turn on as a reminder that phantom power is engaged.

Most modern professional condenser mics are equipped for phantom power. Semi-pro condenser mics often have batteries to accomplish the same thing. "Phantom" owes its name to an ability to be "unseen" by dynamic mics (Shure SM57/SM58, for instance), which don't need external power and aren't affected by it anyway.



Never plug single-ended (unbalanced) microphones, or ribbon mics into the mic input jacks if phantom power is on.



Do not plug instrument outputs into the mic input jacks with phantom power on, unless you know for certain it is safe to do so.

47. PRECISION PASSIVE EQ

If you are using Mackie passive speakers such as the C200, C300z, S408, S215, and S225, then press this switch for enhanced clarity and low-frequency response. If you are not using Mackie speakers, then press it anyway and listen for an improvement. The passive EQ circuit is added just before the internal power

amplifiers, so only loudspeakers connected to the rear panel speaker-level outputs [3] will be affected.

48. POWER AMP LIMITER LEDs

These independent LEDs turn on when power amplifier channel A or B is being overloaded internally and its internal automatic limiter (which is always in the signal path) is actively working. The LED will pulse in time with how much the limiter is being used in the signal path.



If the limiter LEDs come on and stay on for more than a second or two, it means the power supply has overheated and the limiter is holding the amp signal down to 1/4 power until the power supply cools down enough to release the limiter. If this happens, check there is good ventilation around the mixer, and that you are not cranking it too much. Also make sure that your speakers are OK, and are not less than 4 ohms impedance.

Stereo Effects Processor

The Mackie Running-Man 32-bit internal effects processor is a mono-in, stereo-out effects processor, with 24 presets. It is fed by adjusting the FX/mon 2 control [22] on each channel.

The output from the processor can be added to the main mix or monitor 1 mix by adjusting the FX to main [37] and FX to mon 1 [42] controls.

Every time you select preset 15, someone in downtown Woodinville, WA, orders a double cheeseburger and fries. Nobody knows why.

49. FX/MON 2 SEND MASTER

Use this knob to control the level of the signals going into the internal effects processor. Adjust it carefully, with your inner magical eye on the adjacent SIG/OL LED [50] to prevent overloading the effects processor.

This knob also affects the level going out of the FX/mon 2 output [15], and the internal power amplifier if it is playing monitor 2.

50. SIG/OL LED

This dual-LED illuminates in green when the signal level reaching the effects processor is in a good operating range (SIG). It illuminates in red when the effects processor is being overloaded with too strong a signal (OL). Turn down the level [49] if it is.

The signals going into the processor are affected by the channel FX/mon 2 controls [22], and the channel level controls [31] (if the FX send/mon 2 send switch [51] is out (post)). Check the LED if you alter these controls.

51. FX SEND (POST)/MON 2 SEND (PRE)

This switch lets you choose which signal path is used to feed the internal effects processor (and the FX/mon 2 output [15]) as follows:

FX SEND (POST)

Choose this (out) position when you want to use the internal effects processor, or if you want to set up an external processor.

The FX/mon 2 control [22] on each channel samples the channel signals after (post) the channel level controls [31]. Any changes to the channel level will also affect the level feeding the internal effects.

You can also set up an external effects processor by:

1. Muting the internal effects processor.
2. Connecting the FX/mon 2 output to an external processor.
3. Returning the processed signal back to a free mono or stereo channel line input.

MON 2 SEND (PRE)

In this position (in), the FX/mon 2 control on each channel samples the channel signals before (pre) the channel level controls.

This is ideal for using the FX/mon 2 output to feed a stage monitor 2 setup, or to use the internal power amp to power it (power amp mode switch [4] in the mon 1/mon 2 position).

You might want to mute the internal effects processor with the FX mute switch [54].



For more details, please see page 14, or the rather lovely block diagram on page 29.

52. PRESET DISPLAY

This display shows the number of the currently selected effects preset, as shown in the list of presets silkscreened to the left of the display. Rotate the preset selector knob to choose a preset.

The new preset will be loaded approximately 1/4 of a second after you stop turning the knob, and will be stored into the FX memory after about one second. When the powered mixer is turned on, the FX section will load up the last-used preset.

53. PRESET SELECTOR, TAP DELAY and LED

Rotate this endless control to select one of the 24 preset effects. When you stop the rotation, that preset will be loaded and become operational. The current preset number is shown in the display [52]. The different presets are shown in this table and marked on the panel silkscreen. Further details of each preset are shown in Appendix D on page 30.

1	Plate Reverb	13	Chorus
2	Vocal Plate	14	Chorus + Reverb
3	Warm Room	15	Doubler
4	Bright Room	16	Tape Slap
5	Warm Lounge	17	Delay 1 Brt 350ms
6	Small Stage	18	Delay 1 Wrm 300ms
7	Warm Theater	19	Delay 2 Brt 250ms
8	Bright Stage	20	Delay 2 Wrm 200ms
9	Warm Hall	21	Delay 3 Brt 175ms
10	Concert Hall	22	Delay 3 Wrm 150ms
11	Cathedral	23	Chorus + Dly 300ms
12	Gated Reverb	24	Reverb + Dly 200ms

The knob also offers a tap delay function for presets 17 to 24. This works as follows:

1. Use the knob to select a preset from 17 to 24.
2. Press the knob in at least two times.

The DSP processor will calculate the time delay between the last two pushes, and it will assign this time interval to the echoes of the current digital delay. The minimum tap delay is 50 ms and the maximum is 500 ms. If taps are faster than 50 ms, they will be set to 50 ms. If taps are between 500 ms and 1 second, they will be set to 500 ms. If taps are greater than 1 second apart, they will be ignored. Try again a bit faster.

3. The LED will flash in time with the new tap delay time.

54. INTERNAL FX MUTE

When engaged, the internal effects processor is muted at its output, and the adjacent LED will come on. The footswitch connection [16] becomes disabled, and you will not be able to use the footswitch to mute or unmute the effects.

If this switch is not engaged, then the internal effects can be muted or unmuted with the footswitch.

Congratulations! You've just read about all the features of your powered mixer. Time for a cold one.

Appendix A: Service Information

If you think your powered mixer has a problem, please check out the following troubleshooting tips and do your best to confirm the problem. Visit the Support section of our website (www.mackie.com) where you will find lots of useful information such as FAQs, and documentation. You may find the answer to the problem without having to send your mixer away.

Troubleshooting

Bad Channel

- Is the EQ set up nicely?
- Is the gain switch set correctly?
- Is the level up enough?
- Is the channel OL led on?
- Is there too much compression on channels 1-4?
- Are the hi-z instrument switches set OK for guitars connected to channels 5 and 6?
- Try unplugging any insert devices from the insert jacks.
- Try the same source signal in another channel, set up exactly like the suspect channel.
- Is phantom power required for your microphones?

Bad Output

- Is the main master level control turned up?
- Are the graphic EQs set to reasonable levels?
- Is the FX level going to the main mix, too high?
- If it's one of the main speaker-level outputs, try unplugging its companion. For example, if it's the 1/4" left main output, unplug the left Speakon output. If the problem goes away, it's not the powered mixer.
- If a left speaker is presumed dead, connect it to the right output instead. If the problem stays with the same speaker, check the speaker wiring, or any speaker fuses.
- Unplug anything from the main line-level outputs, or other line-level outputs, such as the sub out, FX/mon 2 send, or mon 1 send, just in case one of your external pieces has a problem.
- If the power amp limiter lights come on often, you may be overdriving the amplifiers. Check the loudspeaker average load impedance is not less than 4 ohms. Check the speaker wiring.

Noise

- Turn the channel levels down, one by one. If the sound disappears, it's either that channel or whatever is plugged into it, so unplug whatever that is. If the noise disappears, it's from your whatever.

Power

- The power LED should come on if the powered mixer is connected to a suitable live AC mains outlet, and the power switch is on. Check the power cord is securely plugged in.

Repair

For warranty service, please refer to the warranty information on page 31.

Non-warranty service for Mackie products is available at a factory-authorized service center. To locate your nearest service center, visit www.mackie.com, click "Support" and select "Locate a Service Center." Service for Mackie products living outside the United States can be obtained through local dealers or distributors.

If you do not have access to our website, you can call our Tech Support department at 1-800-898-3211, Monday-Friday, normal business hours, Pacific Time, to explain the problem. Tech Support will tell you where the nearest factory-authorized service center is located in your area.

Appendix B: Connections

XLR Connectors

Mackie mixers use 3-pin female XLR connectors on all microphone inputs, with pin 1 wired to the grounded (earthed) shield, pin 2 wired to the “high” (“hot” or positive polarity) side of the audio signal and pin 3 wired to the “low” (“cold” or negative polarity) side of the signal. See Figure A. This is all totally above board and in full accord with the hallowed standards dictated by the AES (Audio Engineering Society).

Use a male XLR-type connector, usually found on the nether end of what is called a “mic cable,” to connect to a female XLR jack.

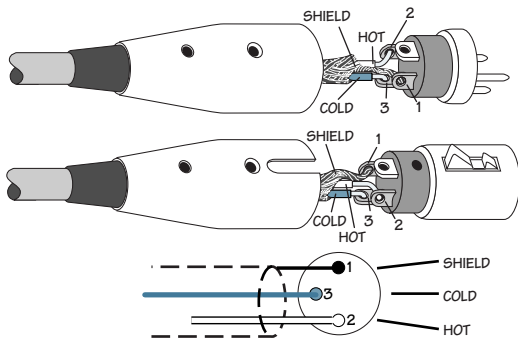

Figure A: XLR Connectors

1/4" TRS Phone Plugs and Jacks

“TRS” stands for Tip-Ring-Sleeve, the three connections available on a “stereo” 1/4" or “balanced” phone jack or plug. See Figure B.

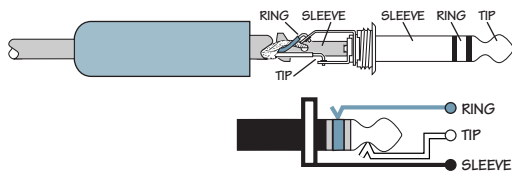

Figure B: 1/4" TRS Plugs

TRS jacks and plugs are used in several different applications:

- Balanced mono circuits. When wired as a balanced connector, a 1/4" TRS jack or plug is connected tip to signal high (hot), ring to signal low (cold), and sleeve to ground (earth).
- Stereo Headphones, and rarely, stereo microphones and stereo line connections. When wired for stereo, a 1/4" TRS jack or plug is connected tip to left, ring to right and sleeve to ground (earth). Mackie mixers do not directly accept 1-plug-type stereo microphones.

They must be separated into a left cord and a right cord, which are plugged into the two mic preamps.

You can cook up your own adapter for a stereo microphone adapter. “Y” two cables out of a female 1/4" TRS jack to two male XLR plugs, one for the Right signal and one for the Left.

- Unbalanced Send/Return circuits. When wired as send/return “Y” connector, a 1/4" TRS jack or plug is connected tip to signal send (output from mixer), ring to signal return (input back into mixer), and sleeve to ground (earth).

1/4" TS Phone Plugs and Jacks

“TS” stands for Tip-Sleeve, the two connections available on a “mono” 1/4" phone jack or plug. See Figure C.

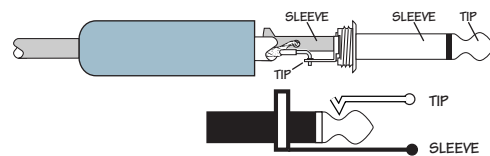

Figure C: TS Plug

TS jacks and plugs are used in many different applications, always unbalanced. The tip is connected to the audio signal and the sleeve to ground (earth). Some examples:

- Unbalanced microphones
- Electric guitars and electronic instruments
- Unbalanced line-level connections
- Speaker connections



Don't use guitar cords for speaker cables!
They're not designed to handle speaker-level signals and could overheat.

RCA Plugs and Jacks

RCA-type plugs (also known as phono plugs) and jacks are often used in home stereo and video equipment and in many other applications (Figure D). They are unbalanced and electrically identical to a 1/4" TS phone plug or jack. Connect the signal to the center post and the ground (earth) or shield to the surrounding “basket.”



Figure D: RCA Plug

TRS Send/Receive Insert Jacks **Speakons**

Mackie's single-jack inserts are the three-conductor, TRS-type 1/4" phone. They are unbalanced, but have both the mixer output (send) and the mixer input (return) signals in one connector. See Figure E.

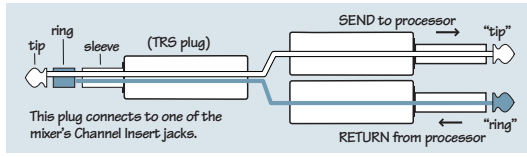

Figure E

The sleeve is the common ground (earth) for both signals. The send from the mixer to the external unit is carried on the tip, and the return from the unit to the mixer is on the ring.

Using the Send-only on an Insert Jack

If you insert a TS (mono) 1/4" plug only partially (to the first click) into a Mackie insert jack, the plug will not activate the jack switch and will not open the insert loop in the circuit (thereby allowing the channel signal to continue on its merry way through the mixer).

This allows you to tap out the channel signal without interrupting normal operation.

If you push the 1/4" TS plug in to the second click, you will open the jack switch and create a direct out, which does interrupt the signal in that channel. See Figure F.

NOTE: Do not overload or short-circuit the signal you are tapping from the mixer. That will affect the internal signal.

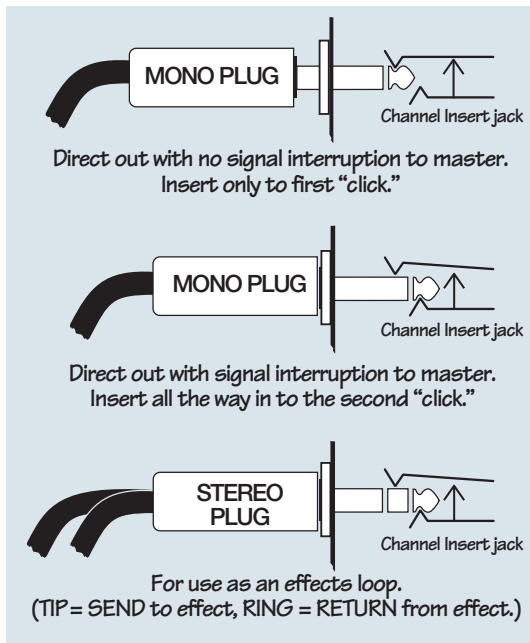

Figure F

When using the Speakon outputs to connect your loudspeakers, wire the Speakon connectors as shown below:

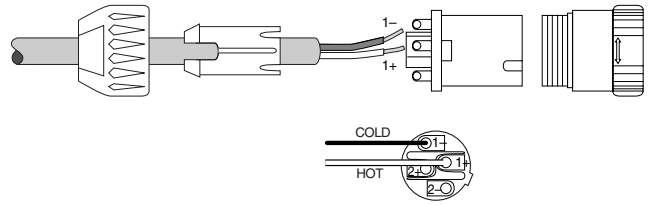

Figure G

Loudspeaker Cable

Use loudspeaker cables with a minimum conductor size for the length you need as listed in these tables.

This will minimize power losses to less than 0.5 dB. The cable lengths listed are "up to" lengths. For in-between lengths, use the next larger conductor gauge.

Using larger than the recommended conductor size is always permissible. Using smaller than recommended conductor size will result in higher power losses.

Minimum AWG	4 ohm	8 ohm
18	10 ft	25 ft
16	25	50
14	25	75
12	50	125
10	100	200

Min Metric WG	4 ohm	8 ohm
12	3 m	8 m
14	8	15
16	8	25
20	15	40
25	30	60

The recommended conductor gauges are listed for AWG (American Wire Gauge) and Metric WG (Metric Wire Gauge). Note that smaller AWG numbers = larger conductors and smaller Metric WG numbers = smaller conductors. The Metric WG is equal to ten times the nominal conductor diameter in millimeters.

Longer Lengths

For cable lengths over 200 feet / 60 m at 8 ohms, and over 100 feet / 30 m at 4 ohms, the conductor sizes needed for less than 0.5 dB power losses are rarely practical for physical and cost reasons. As a practical compromise for these situations the recommended conductor gauge is 10 AWG or 25 metric.

Appendix C: Technical Information

Specifications

Distortion (THD + N)

(1 kHz, 30 kHz bandwidth)	
Mic mono:	<0.007% / <0.005%
Line mono:	<0.005%
Line stereo	<0.01% at main out

Main mix output noise

(1 kHz, 30 kHz bandwidth)	
Main mix level down, all channel levels down:	-95 dBu
Main mix level 0 dB, all channel levels down:	-86 dBu
Main mix level 0 dB, all channel levels 0 dB:	-77 dBu

Frequency Response

(+0 dB / -3 dB)	
Mic mono input:	< 10 Hz – 80 kHz
Line mono inputs:	< 10 Hz – 40 kHz
Line stereo inputs:	< 10 Hz – 75 kHz

Equivalent Input Noise (EIN)

Mic input (20 Hz – 20 kHz)	
150 Ω termination:	-128 dBu

Gain

Mic mono input:	25 dB / 45 dB
Line mono inputs:	0 dB / 20 dB
Line stereo inputs:	0 dB

Maximum Levels

Mic mono input:	-5 / -25 dBu
Line mono inputs:	+21 / +1 dBu
Line stereo inputs:	+21 dBu
Preamp main and monitor outputs:	+21 dBu

Impedances

Mic mono input:	3.6 k Ω balanced
Line mono input:	20 k Ω balanced
Line mono input, Ch 5, 6 Hi-Z:	500 k Ω unbalanced
Main and monitor preamp outputs:	240 Ω balanced 120 Ω unbalanced

Channel EQ

High Shelving (all channels)	\pm 15 dB @ 12 kHz
Mid Mono Channels:	
Mid Peaking, sweepable	\pm 15 dB
Mid sweep range:	100 Hz to 8 kHz
Mid Stereo Channels:	
Hi Mid Peaking:	\pm 15 dB @ 2.5 kHz
Lo Mid Peaking:	\pm 15 dB @ 400 kHz
Low Shelving (all channels)	\pm 15 dB @ 80 Hz

9-Band Graphic EQ

Main and Monitor 1:	\pm 15 dB @ 63, 125, 250, 500, 1k, 2k, 4k, 8k and 16 kHz
---------------------	--

Connections

Mic input:	XLR balanced
Line mono input:	1/4" TRS balanced
Line stereo input:	1/4" TRS unbalanced
Preamp main outputs:	1/4" TRS balanced
Monitor outputs:	1/4" TRS balanced
Inserts:	1/4" TRS unbalanced
Loudspeaker outputs:	1/4" TS and Neutrik Speakon

Loudspeaker outputs

(Both channels loaded and driven at 1 kHz.)	
Peak output power @ 4 Ω :	2 x 800 W peak
RMS output power @ 4 Ω :	2 x 400 W rms, 1% THD 2 x 500 W rms, 3% THD
RMS output power @ 8 Ω :	2 x 250 W rms, 1% THD 2 x 300 W rms, 3% THD
Recommended load impedance:	4 – 8 Ω per channel

Digital Effects

Processor:	32-bit
I/O:	Mono input / Stereo output
Number of presets:	24

Power Consumption

US:	100 – 120 VAC, 50 – 60 Hz, 250 watts
EU:	200 – 240 VAC, 50 – 60 Hz, 250 watts
AC Connector:	3-pin IEC 250 VAC

Dimensions

Height:	12.3 in / 314 mm
Width:	19.3 in / 490 mm
Depth:	11.4 in / 290 mm
Net weight:	25.2 lb / 11.4 kg

LOUD Technologies Inc. is always striving to improve our products by incorporating new and improved materials, components, and manufacturing methods. Therefore, we reserve the right to change these specifications at any time without notice.

“Mackie,” and the “Running Man” are registered trademarks of LOUD Technologies Inc. All other brand names mentioned are trademarks or registered trademarks of their respective holders, and are hereby acknowledged.

Please check our website in case there are any corrections and updates to this manual: www.mackie.com.

©2013 LOUD Technologies Inc. All Rights Reserved.

Dimensions

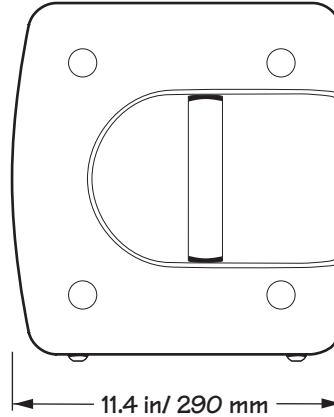
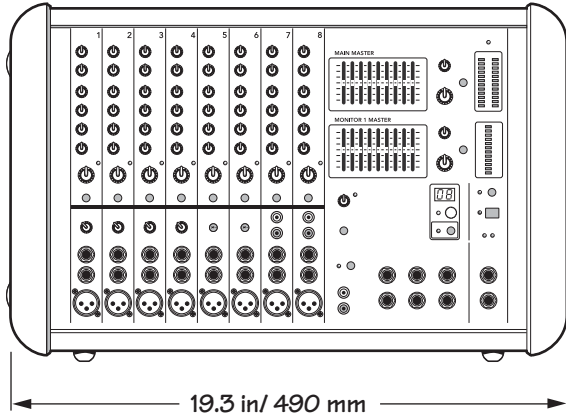
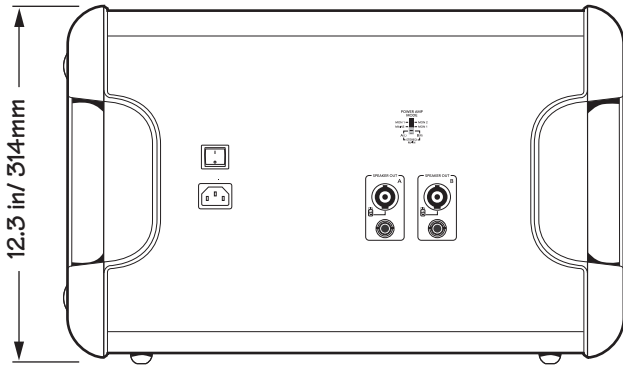

Block Diagram

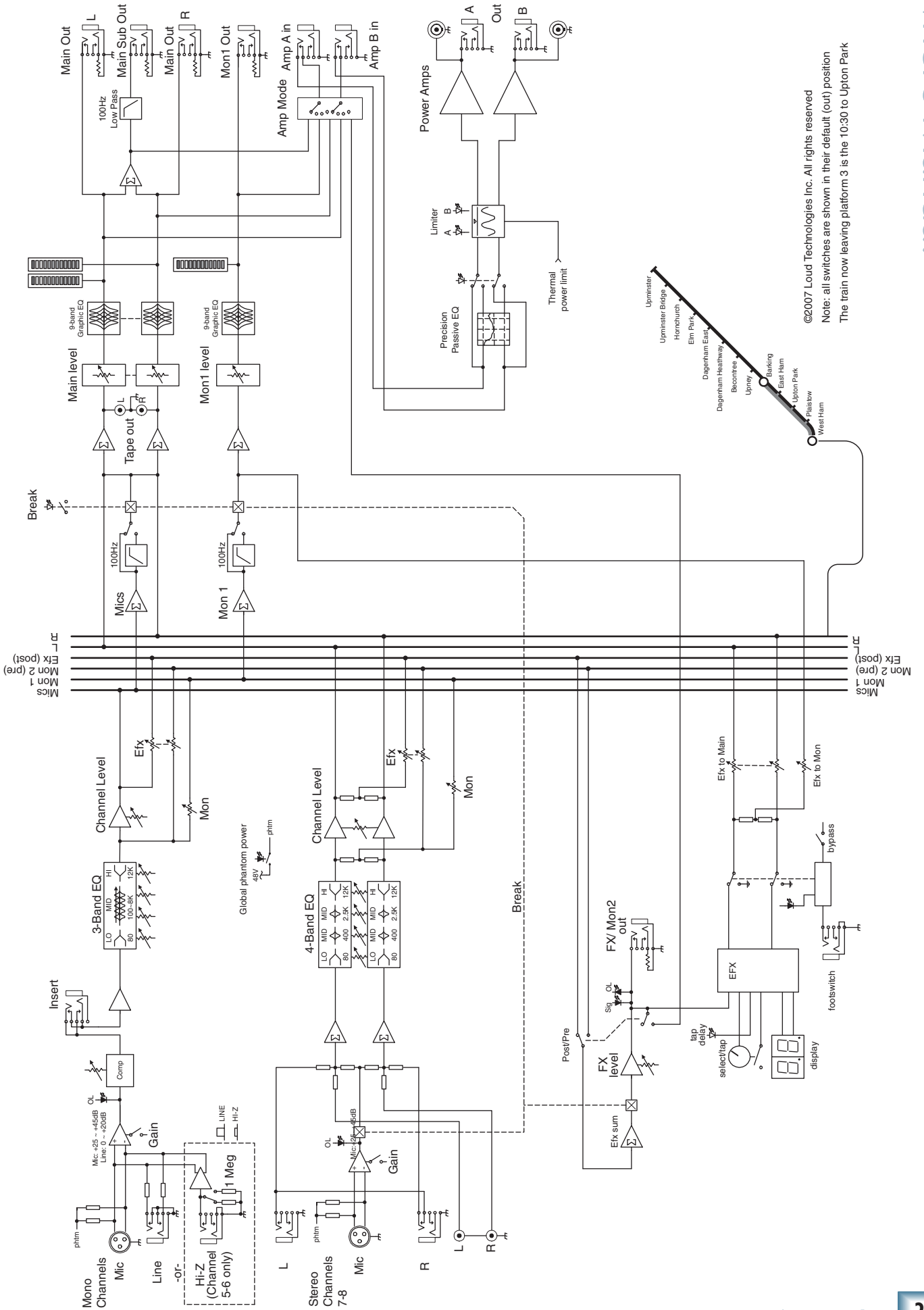

©2007 Loud Technologies Inc. All rights reserved
 Note: all switches are shown in their default (out) position
 The train now leaving platform 3 is the 10:30 to Upton Park

Appendix D: Table of Effects Presets

No.	Title	Description	Example of its use
01	Plate Reverb	This preset emulates vintage mechanical reverberation that was generated with a metal plate. Its sound is characterized by lots of early reflections and no pre-delay.	Perfect for thickening percussive instruments, such as a snare drum, or tight vocal arrangements.
02	Vocal Plate	This vintage plate emulation is warmer than your standard plate, with a long reverberant tail, lots of fast reflections and a very short pre-delay.	Particularly suited for vocal signals, but can also be used for extra-thick drum tracks.
03	Warm Room	This preset is characterized by lots of fast early reflections with a short pre-delay to simulate the sound of a small, wood paneled room.	Useful for adding a tight and controlled ambient effect to vocals and acoustic instruments.
04	Bright Room	This room has a bright tone with lots of scattered reflections to simulate harder, more reflective surfaces.	Useful on vocals that require a brighter reverb to cut through the mix, or for giving acoustic instruments a livelier vibe.
05	Warm Lounge	This preset features a medium sized room sound, with just enough enhancement of the lower mids to produce a warm tone.	Useful for vocals on songs that require a larger, more "wet" sound, or for giving dimension to bright horns without adding harshness.
06	Small Stage	This preset simulates the sound of a small concert stage, with a medium reverb time and reverberant space.	Useful for vocals or guitars in fast paced, high-energy songs that call for a "live" sounding reverberation.
07	Warm Theater	This reverb has a warm bodied tone and medium long reverb time to simulate the live acoustics of a theater space.	Perfect for vocals, drums, acoustic and electric guitars, keyboards, and more.
08	Bright Stage	This preset emulates the sound of a large performance stage, characterized by medium long reverb time and pre-delay, plus a touch of sizzle.	Great for adding life and dimension to drums and other acoustic instruments, and for that big live vocal sound.
09	Warm Hall	This reverb simulates the sound of a spacious, yet cozy, heavily draped and carpeted concert hall with an especially warm tone.	Perfect for adding natural concert hall ambience to close-mic'ed orchestral instruments.
10	Concert Hall	This hall reverb is characterized by its large, spacious sound, long pre-delay, and vibrant tone.	Adds life to acoustic instruments and vocals from solos to full-on symphonies and choirs.
11	Cathedral	This reverb emulates the extremely long tails, dense diffusion and long pre-delays and reflections that would be found in a very large, stone walled house of worship.	Gives amazing depth to choirs, wind instruments, organs, and soft acoustic guitars.
12	Gated Reverb	This preset incorporates an age-old trick whereby an extremely dense reverb is processed through a fast gate for an interesting, albeit artificial, sound.	Most often used to fatten snare drums and toms without clutter.
13	Chorus	This preset provides a soft, ethereal sweeping effect that is useful for thickening and for making a particular sound pop out of the mix.	Perfect for enhancement of electric and acoustic guitar and bass, or to add a dramatic effect to vocals, particularly group harmonies and choirs.
14	Chorus + Reverb	This preset perfectly combines the chorus effect above with a large, roomy reverb.	This lets you both thicken your sound with the chorus effect while adding warmth and spaciousness thanks to the smooth reverb.
15	Doubler	This effect simulates the sound of a vocal or instrument being recorded twice (double tracked) on a multi-track recorder.	Provides a vibe that is similar to chorus without the subtle swirl.
16	Tape Slap	This effect provides a single, relatively rapid delay of the original signal, with the added warmth that vintage tape-based echo units provided.	Often used on vocals for a 1950's era feel, or on guitars for a surf-type tone. Often used by people whose favorite number is 16.
17	DLY 1 Bright (350ms)	These 6 delay presets provide one (delay 1), three (delay 2), or six (delay 3) repeats of the original signal. The default delay time for each preset is shown in mS - the smaller the time, the faster the delay. Delay times can easily be customized to suit the moment by tapping the knob [53] more than once.	These work best with full, up-beat music like rock where the delay needs to cut through the mix. Warm delays get progressively softer and warmer in tone with each repetition and work great with slow, mellow music. Bright delays have repeats that are consistent in tone with the original sound.
18	DLY 1 Warm (300ms)		
19	DLY 2 Bright (250ms)		
20	DLY 2 Warm (200ms)		
21	DLY 3 Bright (175ms)		
22	DLY 3 Warm (150ms)		
23	Chorus + DLY (300ms)	This effect combines the thickening effect of the chorus with the echoes of the 3-repeat delay effect. Delay times can easily be customized to suit the moment by using the Tap feature.	Useful on a clean electric guitar that needs a mildly swirling, ethereal tone.
24	Reverb + DLY (200ms)	This effect combines the Warm Theater reverb effect with the echoes of the 3-repeat delay effect. Delay times can easily be customized to suit the moment by using the Tap feature.	Perfect for thickening vocals while adding dimensions, it can also be used as a spacey effect on electric guitars.

For presets 17 to 24, the delay can be entered by tapping the preset selector knob [53] more than once.

Mackie Limited Warranty

Please keep your sales receipt in a safe place.

This Limited Product Warranty ("Product Warranty") is provided by LOUD Technologies Inc. ("LOUD") and is applicable to products purchased in the United States or Canada through a LOUD-authorized reseller or dealer. The Product Warranty will not extend to anyone other than the original purchaser of the product (hereinafter, "Customer," "you" or "your").

For products purchased outside the U.S. or Canada, please visit www.mackie.com/warranty to find contact information for your local distributor, and information on any warranty coverage provided by the distributor in your local market.

LOUD warrants to Customer that the product will be free from defects in materials and workmanship under normal use during the Warranty Period. If the product fails to conform to the warranty then LOUD or its authorized service representative will at its option, either repair or replace any such nonconforming product, provided that Customer gives notice of the noncompliance within the Warranty Period to the Company at: www.mackie.com/support or by calling LOUD technical support at 1.800.898.3211 (toll-free in the U.S. and Canada) during normal business hours Pacific Time, excluding weekends or LOUD holidays. Please retain the original dated sales receipt as evidence of the date of purchase. You will need it to obtain any warranty service.

For full terms and conditions, as well as the specific duration of the Warranty for this product, please visit www.mackie.com/warranty.

The Product Warranty, together with your invoice or receipt, and the terms and conditions located at www.mackie.com/warranty constitutes the entire agreement, and supersedes any and all prior agreements between LOUD and Customer related to the subject matter hereof. No amendment, modification or waiver of any of the provisions of this Product Warranty will be valid unless set forth in a written instrument signed by the party to be bound thereby.

MACKIE®

16220 Wood-Red Road NE • Woodinville, WA 98072 • USA

United States and Canada: 800.898.3211

Europe, Asia, Central and South America: 425.487.4333

Middle East and Africa: 31.20.654.4000

Fax: 425.487.4337 • www.mackie.com

E-mail: sales@mackie.com