

Soundcraft®

— Realtime Rack —



Realtime Rack Manual

Software Version 8.6

Manual Version 161114



[Technical Support](#)

Table Of Contents

Tip: Click any section or page number to jump directly to that page.

Chapter 1: Introduction	13
Welcome to Soundcraft Realtime Rack!	13
Realtime Rack Features.....	14
Hardware	14
Software	14
Package Contents	14
Realtime Rack System Overview	15
Soundcraft Vi Series Consoles	15
Realtime Rack Hardware	15
Realtime Rack Software Application	15
UAD Powered Plug-Ins	16
UAD Meter & Control Panel Software Application	16
<i>UAD Meter</i>	17
<i>UAD Control Panels</i>	17
UA Online Store.....	17
Documentation Overview	18
Realtime Rack Manual	18
UAD Plug-Ins Manual.....	18
Direct Developer Plug-Ins	18
Soundcraft Vi Series Consoles	18
Hyperlinks.....	18
Chapter 2: Hardware	19
Hardware Overview.....	19
Front Panel	19
(1) HOST Indicator	19
(2) PSU Indicators	20
<i>PSU Indicator notes:</i>	20
(3) POWER Indicator.....	20
(4 & 5) MADI Indicators	20
(4) <i>MADI IN Indicator</i>	20
(5) <i>MADI OUT Indicator</i>	20
(6) RESET Button	20

Rear Panel	21
(1) AC Power Inputs	21
(2) Power Switches	21
Automatic Failover	21
(3) Thunderbolt Ports	22
(4) Word Clock Out	22
(5) Word Clock In.....	22
(6) Word Clock Termination Switch	23
(7) 1394b Ports	23
(8 & 9) MADI I/O Ports.....	23
(8) MADI OUT	23
(9) MADI IN	23
Standalone Behavior	24
Chapter 3: System Setup.....	25
Overview	25
System Requirements	25
System Connections.....	26
About Realtime Rack system connections.....	26
About Vi Console HiQNet (Ethernet) connections	26
Single Unit Wiring.....	27
Multi-Unit Wiring.....	28
Software Installation	29
Preparation	29
Software Installation Procedure.....	29
<i>About Firmware Updates</i>	<i>29</i>
Device Registration & Authorization.....	30
About Registration	30
About Authorization	30
Authorization Procedure	30
Offline Authorization Procedure.....	31
Operating System Software Configuration.....	33
Mac OS X System Preferences.....	33
<i>Energy Saver Panel</i>	<i>33</i>
<i>Computer Sleep.....</i>	<i>33</i>
<i>Display Sleep</i>	<i>33</i>
<i>Wake for network access.....</i>	<i>34</i>
<i>Power Adapter Tab</i>	<i>34</i>
<i>Battery Tab.....</i>	<i>34</i>
Realtime Rack Software Configuration	35
<i>Sample Rate.....</i>	<i>35</i>
<i>Clock Source</i>	<i>35</i>
<i>MADI Bank.....</i>	<i>35</i>

Chapter 4: Realtime Rack Application	36
Application Overview	36
Concepts.....	36
<i>View Screens</i>	36
<i>Global Displays</i>	37
<i>Navigation</i>	37
<i>Keyboard Focus</i>	37
<i>Edit & Safe Modes</i>	37
<i>Offline Configuration</i>	37
Entering & Exiting the Application	38
<i>Launch</i>	38
<i>Full Screen Display</i>	38
<i>Hide/Switch</i>	38
<i>Quit</i>	38
Navigation Overview	40
Views Overview	40
<i>Inserts</i>	40
<i>Gains</i>	40
<i>Delay Groups</i>	40
<i>Channel</i>	40
<i>Snapshots</i>	40
<i>Settings</i>	40
Global Navigation Elements	41
Info Bar	41
Main Column.....	41
<i>View Menu</i>	42
<i>View Options</i>	42
<i>Bank Views</i>	42
Channels Bar.....	42
<i>Channel Select Buttons</i>	42
Banks	43
<i>Current Bank</i>	43
<i>Bank Size</i>	43
<i>Bank Bar</i>	43
<i>Bank Bar Navigation</i>	43
<i>Bank Concept</i>	44
Meter Bridge	44
<i>Input Meters</i>	44
<i>Meter Bridge Navigation</i>	45
Navigation Scroll Bars	45
Keyboard Focus	46
<i>Focus Indication</i>	46
<i>Focus Navigation</i>	46
Keyboard Shortcuts.....	47

Global Screen Elements	48
View Elements	48
Main Column.....	48
<i>View Menu</i>	49
<i>View Options</i>	49
<i>Bank Views</i>	49
<i>Quit</i>	49
<i>Column Placement</i>	49
Meter Bridge	50
<i>Input Meters</i>	50
<i>Bank Bar</i>	50
<i>Meter Bridge Navigation</i>	50
Channels Bar.....	51
<i>Current Bank</i>	51
<i>Bank Size</i>	51
<i>Channel Select Buttons</i>	51
<i>Bank Bar</i>	52
Info Bar	53
<i>Info Bar Placement</i>	53
<i>Info Bar Elements</i>	53
<i>Operating Mode</i>	54
<i>EDIT Mode</i>	54
<i>SAFE Mode</i>	54
<i>Safe Mode Constraints</i>	55
<i>Snapshot Display</i>	55
<i>Clock Display</i>	56
<i>Tempo Display</i>	57
<i>Changing tempo values within the tempo dialog</i>	57
<i>Changing tempo values via MIDI</i>	58
<i>About external MIDI tap tempo control</i>	58
<i>Resource Display</i>	59
<i>UAD Resource Loads</i>	59
<i>DSP</i>	60
<i>Program</i>	60
<i>Memory</i>	60
Inserts View	61
Current Bank Channels.....	61
<i>Bank Size</i>	61
Channel Column	62
<i>Insert Slots</i>	62
<i>Channel Signal Flow</i>	62
<i>State Indication</i>	62

Inserts Options Overview.....	63
<i>Option Latch</i>	63
<i>Option Unlatch</i>	63
<i>Timeout Length</i>	63
<i>Modifiers</i>	63
<i>Modifier Swipe Shortcuts</i>	63
Inserts Option Descriptions.....	64
<i>Power</i>	65
<i>Remove</i>	65
<i>Move</i>	65
<i>Copy</i>	66
<i>Paste</i>	66
<i>Isolate</i>	67
Gains View	68
<i>Bank View</i>	68
<i>Channel Column</i>	68
<i>Bank Channels</i>	68
Gain Elements.....	69
<i>I/O Type</i>	69
<i>Gain Value</i>	69
<i>Gain Fader</i>	69
<i>Fader Handle</i>	70
<i>Channel Number & Name</i>	70
<i>Link/Unlink</i>	70
Gains Options.....	71
<i>Inputs</i>	72
<i>Outputs</i>	72
<i>Both</i>	72
<i>Default</i>	72
<i>Isolate</i>	72
Delay Groups View	73
<i>Bank View</i>	73
<i>Channel Column</i>	73
<i>Bank Channels</i>	73
Delay Groups Overview	74
<i>Upsampled UAD plug-ins</i>	74
<i>How Delay Groups work</i>	74
<i>When To Use Delay Groups</i>	74
<i>System Latency</i>	74
Delay Groups Options.....	75
<i>Delay Group Button Selectors</i>	75
<i>Compensation Menu</i>	75

Delay Groups Elements.....	76
<i>Active Delay Group Display</i>	76
<i>Delay Group Buttons</i>	76
<i>Samples Display</i>	76
<i>Output Meter</i>	77
Configuring Delay Groups.....	77
Delay Groups Example.....	78
Upsampling Values Table	79
Channel View	81
Navigating to Channel View.....	81
Selecting Channels within Channel View	81
Two View Modes: Single View & Channel Strip View	82
<i>View Mode Elements</i>	82
<i>Switching View Modes</i>	82
<i>Common Elements</i>	82
Channel View Options.....	83
<i>Channel Name Button</i>	83
<i>Channel Name Field</i>	83
<i>Channel Link/Unlink</i>	83
Insert Buttons	84
<i>Insert Button Behavior</i>	84
<i>Channel Signal Flow</i>	85
<i>Insert Reordering</i>	85
<i>Insert State Indications</i>	85
<i>Channel Strip Button</i>	86
<i>Remove Plug-In Shortcut</i>	86
Channel I/O Gains.....	86
PLUG-IN Tab.....	87
<i>General Use</i>	87
<i>Specific Controls</i>	87
<i>Channel Strip View</i>	88
<i>Status Bar</i>	89
<i>Power Button</i>	90
<i>Zoom Slider</i>	90
PRESETS Tab.....	91
<i>Presets Defined</i>	91
<i>Channel Strip Defined</i>	92
<i>PRESETS Tab Columns</i>	93
<i>FILE Column</i>	93
<i>PRESETS Column</i>	94
<i>SUB-FOLDER Column</i>	94

ASSIGN Tab	95
<i>CATEGORY Buttons</i>	95
<i>Plug-In Categories</i>	96
How To Assign Inserts	96
<i>Assign Insert</i>	96
<i>Reassign Insert</i>	97
<i>De-assign Insert</i>	97
Snapshots View	98
Snapshot Defined	98
<i>Snapshots Folder Location</i>	98
<i>Snapshot Versus System Contents</i>	99
Snapshot Key Commands	99
Recalling Snapshots.....	100
<i>Base Snapshot Workflow</i>	100
File Columns	101
Snapshots Term Definitions.....	102
Navigating to Snapshots View.....	102
Keyboard Focus & Navigation.....	102
Folders Column	103
<i>To Select a Folder:</i>	103
Snapshots Column	104
To Prime and Recall a Snapshot:	104
<i>MIDI Bank & Program Change Recall</i>	105
Snapshots Options	105
<i>Save Button</i>	105
<i>Save As Button</i>	106
<i>New Button</i>	106
<i>FOLDER/SNAPSHOT Options</i>	106
<i>Rename Button</i>	106
<i>Delete Button</i>	107
<i>Move Button</i>	107
<i>Move Shuffle</i>	108
IMPORT/EXPORT	108
<i>Export All</i>	108
<i>Import All</i>	109
Recall Panel.....	110
<i>Active Snapshot Display</i>	110
<i>Primed Snapshot Display</i>	110
<i>Recall Snapshot Button</i>	110
<i>Up/Down Buttons</i>	110
Universe View.....	111
<i>Plug-In State Buttons</i>	111
<i>Navigating with Universe View</i>	111

Settings View	112
Navigating to Settings View.....	112
<i>Settings Tab Names</i>	112
Hardware Tab	113
<i>Sample Rate Menu</i>	113
<i>Clock Source Menu</i>	113
<i>MADI Channels Menu</i>	113
<i>Device Buttons</i>	114
Display Tab	114
<i>Bank Size Menu</i>	114
<i>Column Location Menu</i>	115
<i>Info Location Menu</i>	115
<i>Monitors Menu</i>	115
<i>Timeout Length Menu</i>	115
MIDI Tab.....	115
<i>MIDI Device Menu</i>	116
<i>MIDI Channel Field</i>	116
<i>MIDI Tap Tempo</i>	116
Plug-Ins Tab	117
<i>Hide Button</i>	117
<i>Info Button</i>	117
<i>Buy Button</i>	117
<i>Status Column</i>	118
<i>Controls Mode Menu</i>	118
Soundcraft Snapshot Recall.....	119
Workflow with Vi Consoles.....	119
Chapter 5: UAD Meter & Control Panel	120
Overview	120
Launching the Application	120
Using the UAD Meter	121
UAD Meter Elements.....	121
Menu Button	121
Drop Menu	121
Always On Top	122
Title Bar.....	122
Plug-Ins Panel Button	122
Resource Gauges	122
<i>Averaged Loads</i>	122
<i>Individual Loads</i>	122
DSP.....	123
Program.....	123
Memory	123

UAD Control Panels	124
Accessing the Control Panels	124
<i>Drop Menu</i>	124
<i>Panel Buttons</i>	124
System Information Panel.....	125
Software Section.....	125
<i>Version String</i>	125
Hardware Section.....	126
<i>Device Status</i>	126
<i>Device Enabled</i>	126
<i>DSP Load</i>	126
<i>Save Detailed System Profile</i>	126
Plug-Ins Panel	127
Authorize Plug-Ins button	127
Plug-In Column	128
Status Column.....	128
<i>Authorized for devices</i>	128
<i>Start Demo</i>	128
<i>Demo Active (days remaining)</i>	128
<i>Demo Expired</i>	128
Help Column	128
Buy Column	128
Configuration Panel.....	129
UAD-2 DSP Settings	129
<i>DSP Load Limiting Overview</i>	129
<i>Limit DSP Load</i>	130
<i>DSP LoadLock</i>	130
User Interface Settings.....	131
<i>Controls Mode</i>	131
<i>Use Host Mode</i>	131
<i>Toggle initial value modifier</i>	131
Info Display.....	131
Help & Support Panel	132

Chapter 6: Using UAD Powered Plug-Ins	133
The UAD Plug-In Window	133
Status Bar.....	133
Adjusting Parameters	134
Text Entry.....	134
Scroll Wheel.....	134
Keyboard Control	135
Shortcuts	135
DSP Loading Information.....	136
Operating Levels.....	136
Tempo Sync	137
Overview	137
Tempo Sync Plug-Ins.....	137
Sync Activation.....	137
Available Tempo Sync Note Values.....	138
Range Limits	139
<i>Out of range</i>	139
Entering Tempo Values	139
<i>Arrow Keys</i>	139
<i>Text Entry</i>	139
Precision Delay Modes with Tempo Sync	140
Roland RE-201 Sync	140
Chapter 7: UA Online Store	141
UA Store Overview	141
Optional Plug-Ins.....	141
Bundled Plug-Ins.....	141
Plug-Ins are already installed	141
Coupons.....	141
My.Uaudio	142
Registration.....	142
UA Account.....	142
My Profile	142
UAD Authorization Overview.....	143
My Systems.....	143
UAD System.....	143
Account Creation and Device Registration	143
Adding Additional UAD Devices.....	143
Authorizing Newly-Purchased UAD Plug-Ins.....	143
Authorizations Are Stored On UAD Device	143
Demo Mode.....	144
Demo Reset.....	144
Demo Activation	144

Buying Plug-Ins.....	145
Purchase Procedure	145
Transfer Video.....	146
Chapter 8: Specifications	147
Chapter 9: Notices.....	149
Maintenance	149
Warranty & Repair	149
<i>Products Under Warranty</i>	<i>149</i>
<i>Out-Of-Warranty Products</i>	<i>149</i>
Important Safety Information	150
FCC Compliance	151
Hardware Terms and Conditions	152
Software End User License Agreement.....	152
Disclaimer.....	152
Trademarks	152
Copyright	152
Chapter 10: Technical Support.....	153
Soundcraft: Support for Vi Series Consoles and Realtime Rack Hardware	153
<i>Soundcraft Tech Support (UK).....</i>	<i>153</i>
<i>Soundcraft Tech support (USA)</i>	<i>153</i>
Universal Audio: Support for Realtime Rack Software and UAD Plug-Ins	153
<i>Realtime Rack Software Knowledge Base</i>	<i>153</i>
<i>Contact Universal Audio Support</i>	<i>153</i>

Chapter 1: Introduction

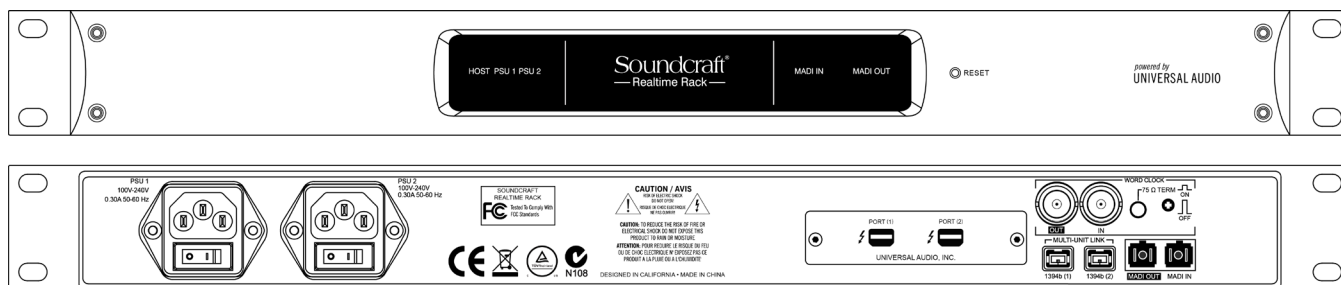

Welcome to Soundcraft Realtime Rack!

The result of a unique collaboration between live sound mixing experts Soundcraft and renowned plug-in manufacturer, Universal Audio, the Soundcraft Realtime Rack brings industry-standard UAD studio plug-ins to the Soundcraft platform. The Realtime Rack hardware and software delivers tight integration of Soundcraft Vi consoles and UAD Powered Plug-Ins, with (48 kHz) sub-2 millisecond latency and full snapshot store and recall with Soundcraft’s CUE/Snapshot system. Realtime Rack’s robust SHARC-based processors run audio over standard Optical MADI connections and dual-redundant internal power supplies ensure that audio signals keep running, even in the event of a power supply failure. Soundcraft Realtime Rack brings the stability of DSP and the sound quality that Soundcraft and Universal Audio are known for in a scalable, low-latency processing environment.

Combining the intuitive Vistonics operator interface with pristine sound quality and powerful mixing features, the Soundcraft Vi Series is already established as the first-choice live sound mixing console for touring and installed applications worldwide.

And now, the Soundcraft Realtime Rack provides access to Universal Audio’s acclaimed analogue audio processing emulations and award-winning UAD plug-ins. Realtime Rack software gives Vi console operators all the control they need to insert UAD plug-ins on individual channels, auxiliary channels, and master busses — just as easily as real hardware. A comprehensive snapshot system allows total recall of all plug-ins and their settings, while tight network integration with the Vi Series ensures that all settings of the application are stored and recalled with the Vi console.

The UAD Powered Plug-Ins platform offers the world’s most authentic analogue hardware emulations and award-winning audio plug-ins. Powered by Universal Audio’s DSP Accelerator hardware, UAD Powered Plug-Ins deliver rich, analogue sound quality that would be difficult or impossible to achieve with native recording systems.

From rare compressors and equalizers, to vintage reverb processors and tape machines, UAD Powered Plug-Ins inject three-dimensional ‘out-of-the-box’ analogue sound to your mixes.

Realtime Rack Features

Hardware

- Durable 1U Rack enclosure
- 4 SHARC DSPs on-board
- Dual-redundant internal power supplies with failover detection
- Each Realtime Rack unit processes up to 16 channels of a MADi stream (add additional units for 32, 48, or 64 channels)
- Runs a huge library of UAD Powered Plug-Ins & UAD Direct Developer Plug-Ins
- Dual-Thunderbolt host connectivity
- One set of MADi optical I/O (64 channels @ 48 kHz)
- Word Clock I/O (BNC) and input termination
- Sample Rate support from 44.1 kHz to 96 kHz
- Clock Support for the following formats: Internal, MADi, Word Clock

Software

- Purpose-built Realtime Rack application for inserting UAD Powered Plug-Ins
- Networked integration with select Soundcraft Vi consoles – allows full remote snapshot triggering and storing
- Create, store, and recall channel strip presets
- Create, store, and recall snapshots
- Up to eight UAD Powered Plug-Ins per-channel
- Meter bridge always displays signal levels on all channels
- Plug-ins are categorized by type for quick assignments
- Large text and graphics for high visibility in live sound environments
- SAFE Mode ensures destructive changes do not occur during a live scenario
- Edit Mode ensures changes can be made as quickly as possible
- Intuitive drag/drop functionality for copy/paste, navigation, and moving plug-ins between inserts and/or tracks
- Most functions can be navigated and executed without a mouse (via computer keyboard)
- Full screen application minimizes visual clutter
- Delay compensation group channels for maintaining phase alignment (critical for drums)
- Application and Snapshots can be configured without connected hardware for offline setup and/or sharing with other operators

Package Contents

- Realtime Rack hardware unit
- Power/AC Mains cables: (1) USA, (1) Europe
- Set of four rack screw with washers
- Getting Started sheet
- For installation software, visit www.uaudio.com/realtimerack/start

Realtime Rack System Overview

Realtime Rack has several components that comprise the complete Realtime Rack system. A brief description of each component is provided below, along with a link to complete details about the component.

Soundcraft Vi Series Consoles

Soundcraft Vi Series consoles are digital mixing/processing systems designed for use in a live sound environment.

Realtime Rack is designed for Vi console integration. Vi consoles integrate with Realtime Rack via two simultaneous control protocols:

MADI – Digital audio streams are routed between Vi consoles and the Realtime Rack hardware unit for signal processing via MADI optical I/O (all UAD plug-in signals are processed in the Realtime Rack hardware unit, not in the Vi console). Use the Vi Console’s powerful Insert and patching system to route signals to and from the Vi console via MADI.

Ethernet – Digital control signals, for saving and loading Realtime Rack configuration snapshots, are routed between Vi consoles and the Mac computer running Realtime Rack software via Ethernet.

Realtime Rack Hardware

The Realtime Rack unit is the 1U rack hardware that performs audio signal processing on digital audio streams via MADI. The hardware unit contains four SHARC DSPs that process the UAD Powered Plug-In algorithms. Each unit can process up to 16 MADI streams, and up to four units can be combined to process a total of 64 MADI streams.

The Realtime Rack hardware is configured and controlled by the Realtime Rack software application.

For complete hardware details, see [“Chapter 2: Hardware” beginning on page 19](#).

Realtime Rack Software Application

The Realtime Rack application is the software interface for the Realtime Rack hardware unit. The software configures and controls the hardware unit(s) and UAD Powered Plug-Ins. The application runs on select Mac computers and it interfaces to the Realtime Rack hardware via Thunderbolt.

***Note:** Although UAD Powered Plug-Ins are operated via the Realtime Rack software, the signal processing is performed on the hardware unit’s SHARC DSP, not the computer’s CPU.*

For complete details about the software application, see [“Chapter 4: Realtime Rack Application” beginning on page 36](#).

UAD Powered Plug-Ins

UAD Powered Plug-Ins are software plug-in titles containing DSP algorithms. UAD plug-ins are loaded and controlled within the Realtime Rack software for signal processing on the four SHARC DSPs in the Realtime Rack hardware. Each UAD plug-in contains a graphical user interface (GUI) and various control parameters that can be manipulated to achieve the desired sonic results.



Typical UAD plug-in interface

UAD Powered Plug-Ins are developed by Universal Audio and also by Direct Developer (3rd-party) partners. A wide range of titles are available that are suitable for nearly every application. The UAD Powered Plug-In titles that are included with Realtime Rack depend on the bundle included with the retail product package:

Core Live – The Core Live bundle includes 15 UAD plug-in titles that were selected as a fundamental base set for live sound applications.

Ultimate Live 2 – The Ultimate Live 2 bundle includes 84 UA-developed titles. Note that Direct Developer titles are not included.

UAD plug-ins that are not included in the retail bundles are optional and purchased separately. Optional UAD plug-ins can be individually evaluated without functional limitations for 14 days in demo mode, and can be purchased anytime at the [UA online store](http://www.uaudio.com) at www.uaudio.com.

For complete details about how UAD Powered Plug-Ins are used within Realtime Rack, see “[Chapter 6: Using UAD Powered Plug-Ins](#)” beginning on page 133. For complete details about individual UAD Powered Plug-Ins, see the [UAD Plug-Ins Manual](#) which is placed on the startup disk during software installation.

Note: *Realtime Rack, like other UAD devices, can only use UAD Powered Plug-Ins which are developed specifically for the UAD DSP accelerator platform. Plug-ins developed for other hosts and platforms (VST, RTAS, AAX, Audio Units, native, etc) cannot be used with the Realtime Rack system.*

UAD Meter & Control Panel Software Application

The UAD Meter & Control Panel is used to authorize licensed UAD plug-ins and configure global functionality that pertains to all UAD devices in the same system (the application is used for all UAD products).

The application consists of two components: The UAD Meter and the UAD Control Panels. Complete documentation for the UAD Meter & Control Panel application is in “[Chapter 5: UAD Meter & Control Panel](#)” beginning on page 120.

UAD Meter

The UAD Meter window (shown at right) displays the current DSP, memory, and FireWire status of all active Realtime Rack hardware (including multiple devices).

Note: These meters are also represented within the Realtime Rack application.

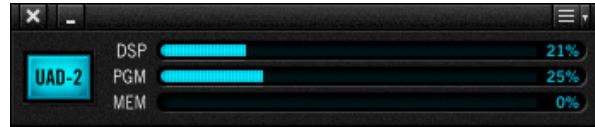

UAD Control Panels

The UAD Control Panel window has multiple panels that display, and enable control of, various UAD system, plug-in, and global configuration parameters.

The screenshot at right shows the System Info panel, one of four control panel windows in the UAD Meter & Control Panel application.

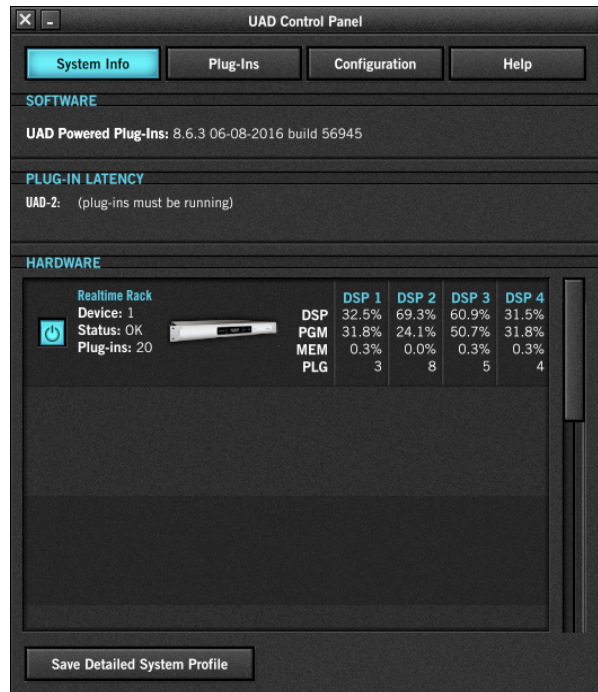

UA Online Store

The UA online store at www.uaudio.com is where optional UAD plug-in licenses can be purchased. Promotional coupons are also redeemed here. All UAD device registrations and plug-in authorizations are managed here as well.

For complete details, see “Chapter 7: UA Online Store” beginning on page 141.

Documentation Overview

Realtime Rack instructions are separated by areas of functionality, as detailed below. Documentation is copied to the computer during software installation (documentation can also be downloaded [here](#)).

All manuals are available in PDF format only. PDF files require a free PDF reader application such as Preview (included with Mac OS X) or Adobe Reader.

After software installation, all Realtime Rack documentation can be found on the computer at the following location:

- /Applications/Universal Audio/

Tip: Documentation can also be accessed by clicking the “View Documentation” button in the Help panel within the UAD Meter & Control Panel application.

Realtime Rack Manual

The Realtime Rack Manual (this document) contains complete information about the hardware unit and how to configure and operate the Realtime Rack software. Included are detailed descriptions for all connections, features, and control functions.

This manual also contains details about the UAD Meter & Control Panel application, obtaining optional UAD plug-in licenses at the UA online store, and more.

UAD Plug-Ins Manual

The features and functionality of all individual UAD Powered Plug-Ins is detailed in the UAD Plug-Ins Manual. Refer to that document to learn about the operation, controls, and user interface of each plug-in that is developed by Universal Audio.

Direct Developer Plug-Ins

UAD Powered Plug-Ins includes plug-ins from Direct Developer partners. Documentation for these 3rd-party plug-ins are separate files that are written and provided by the plug-in developers themselves. The filenames for these plug-ins are the same as the plug-in title names.

Soundcraft Vi Series Consoles

Operating instructions for Vi Series consoles is beyond the scope of Realtime Rack documentation. Refer to Soundcraft documentation for all Vi system operating details.

Hyperlinks

Hyperlinks to other pages in the same file and web pages are [highlighted in blue text](#). Click a hyperlink to jump directly to the linked item.

Tip: Use the “back” button in the PDF reader application to return to the previous page after clicking a hyperlink.

Chapter 2: Hardware

Hardware Overview

The Realtime Rack hardware is the 1U rack device that performs audio signal processing on digital audio streams via MADI optical I/O. The hardware unit contains four SHARC DSPs that process the UAD Powered Plug-In algorithms. Each unit can process up to 16 MADI streams, and up to four units can be combined to process a total of 64 MADI streams. Additionally, each unit has dual-redundant internal power supplies and automatic failover protection.

Each Realtime Rack hardware unit is configured and controlled by the Realtime Rack software application. The MADI channels being processed by each hardware unit is specified in the Settings tab in the Realtime Rack software.

Front Panel

This section describes the function of all visual indicators and controls on the Realtime Rack front panel. There are five visual-only elements and one (recessed) hardware RESET button.

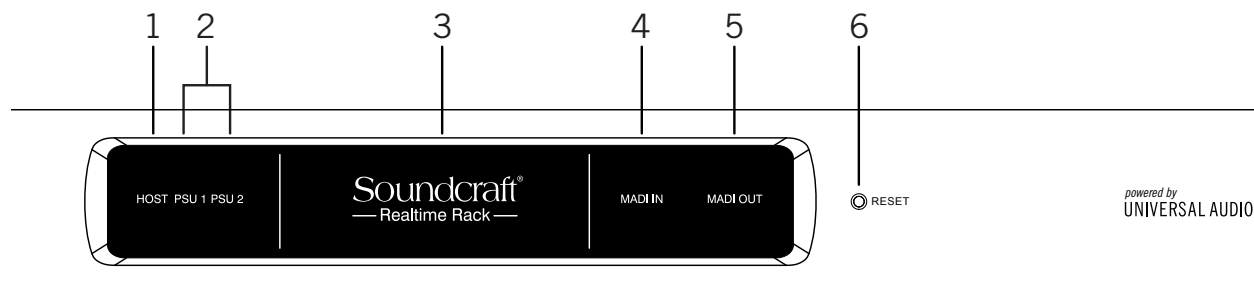

(1) HOST Indicator

The HOST indicator displays the status of the rear panel Thunderbolt connection to the host computer system. The indicator is lit when Realtime Rack is connected to, and properly communicating with, the Mac computer that is running Realtime Rack software.

The Realtime Rack software must be properly installed and configured on the host computer to enable driver connectivity, and the HOST indicator must be illuminated to use Realtime Rack with all computer and Vi console operations.

(2) PSU Indicators

These indicators display the status of the rear panel dual redundant internal power supplies. There is one indicator for each power supply unit (PSU 1 and PSU 2). The color of each indicator displays the status of the PSU as follows:

White – The PSU is operating normally. The PSU is connected to AC power, and the power switch for the PSU (rear panel) is in the ON position.

Red – The PSU is not delivering power. This state is caused by one or more of the following conditions:

- The PSU is not connected to AC power
- The power switch for the PSU is in the OFF position
- The PSU has malfunctioned

PSU Indicator notes:

- If one internal power supply unit fails, Realtime Rack will continue to process audio signals.
- It is normal for the PSU indicator to flash red upon power up of the hardware

(3) POWER Indicator

The Soundcraft Realtime Rack logo is lit when the hardware unit is receiving proper operating voltages from one or both internal power supply units.

(4 & 5) MADI Indicators

These indicators represent whether or not MADI digital audio signals are present at the rear panel MADI I/O connectors. There is one indicator for MADI input and one for MADI output. The state of each indicator represents the MADI signals as follows:

White (bright) – The audio level of any channel in the MADI stream is above -60 dB.

White (dim) – The MADI stream is detected but no channels are above -60 dB.

Black (off) – No audio signals are present in the MADI stream.

(4) MADI IN Indicator

Indicates the state of digital audio signals at the rear panel MADI input connector.

(5) MADI OUT Indicator

Indicates the state of digital audio signals at the rear panel MADI output connector.

(6) RESET Button

This recessed button executes a hardware reset and initializes the unit. Reset should only be performed if there is an unrecoverable failure and all other troubleshooting techniques are exhausted.

***Note:** Pressing this switch interrupts power to the Realtime Rack hardware unit. It performs the same function as manually turning off the unit with the rear panel PSU switches.*

Rear Panel

This section describes the function of all switches and connectors on the Realtime Rack front panel.

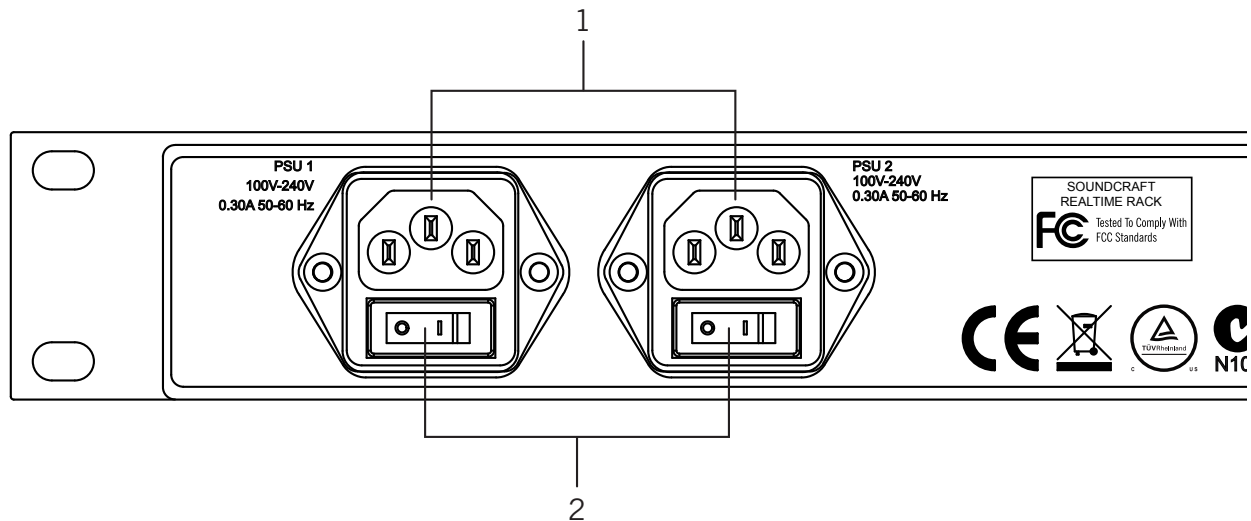

(1) AC Power Inputs

Connect standard detachable IEC power cables to the dual redundant internal power supply units here.

Each PSU accepts 100VAC – 240VAC, 50-60 Hz. The Realtime Rack hardware unit draws a total maximum of 30 Watts of power.

Note: One PSU and power cable can be used if failover operation is not desired.

(2) Power Switches

Each PSU has its own integrated power switch. AC power is passed to the PSU when the switch is in the in (“I”) position.

Automatic Failover

Realtime Rack’s integrated failover circuitry automatically maintains power to the Realtime Rack hardware. In the event that one of the internal power supplies malfunctions or if power to one of the PSUs is interrupted, Realtime Rack will continue to process audio.

Rear Panel (continued)

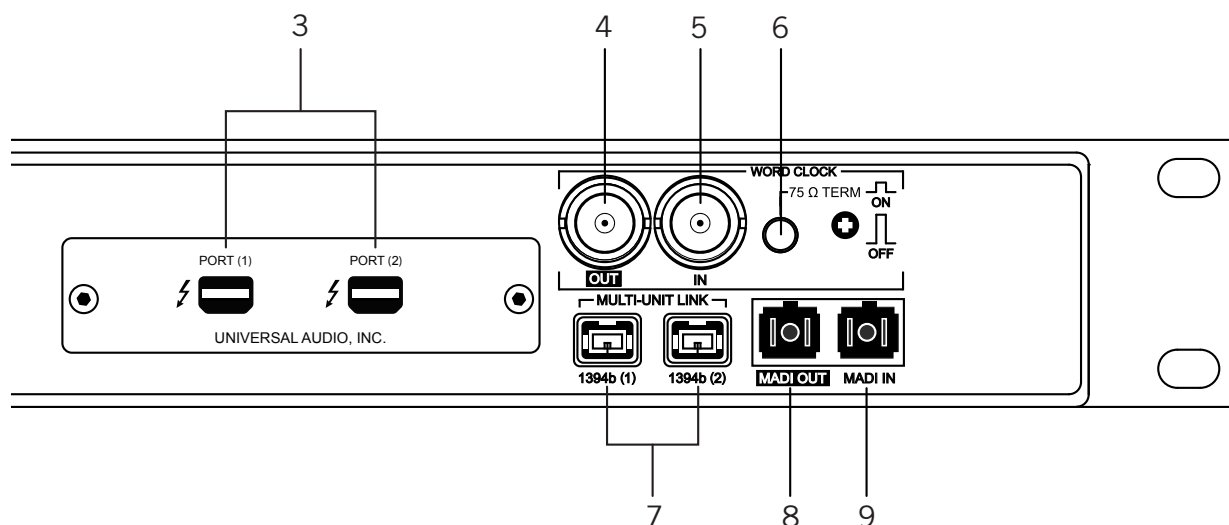

(3) Thunderbolt Ports

Connect a Thunderbolt cable (not included) between one of these ports and the Thunderbolt port on the Mac host computer that is running the Realtime Rack software application. The HOST indicator on the front panel is lit when the connection is established.

Either port can be used for the host computer connection (the port numbers are inconsequential). The other port remains available for other Thunderbolt connections, for example additional Realtime Rack units or the Apple Thunderbolt to Gigabit Ethernet Adapter.

(4) Word Clock Out

This BNC connector transmits a standard (1x) word clock when Realtime Rack is set to use its internal clock. The clock rate sent by this port matches the current system sample rate, as specified in the Hardware tab within the Realtime Rack software application.

When Realtime Rack is set to use external word clock as its clock, Realtime Rack is a word clock slave. If the incoming external word clock is within $\pm 0.5\%$ of a supported sample rate (44.1 kHz, 48 kHz, 88.2 kHz, 96 kHz), Word Clock Out will mirror Word Clock In with a slight phase delay of about 40 nanoseconds.

(5) Word Clock In

Realtime Rack's internal clock can be synchronized (slaved) to an external master word clock. This is accomplished by setting Realtime Rack's clock source to Word Clock in the Hardware tab within the Realtime Rack software's Settings view, connecting the external word clock's BNC connector to Realtime Rack's word clock input, and setting the external device to transmit word clock. If Realtime Rack is the last device in the clock chain, the Termination switch (6) should be engaged.

Note: Realtime Rack can be synchronized to an external "1x" clock signal only. Superclock, overclocking, and subclocking are not supported.

(6) Word Clock Termination Switch

This pushbutton switch provides internal 75-ohm word clock input signal termination when required. Word clock termination is active when the switch is engaged (depressed).

Realtime Rack's termination switch should only be engaged when Realtime Rack is set to sync to external word clock and it is the last device at the receiving end of a word clock cable. For example, if Realtime Rack is the last "slave" unit at the end of a clock chain (when Realtime Rack's word clock out port is not used), termination should be active.

(7) 1394b Ports

The 1394b ports are for development and manufacturing purposes only. They have no functionality within the Realtime Rack system.

***Important:** Do not attach any devices to the 1394b ports, and do not connect the FireWire ports to a host computer.*

(8 & 9) MADI I/O Ports

The MADI I/O ports are used for digital audio interconnections between the Realtime Rack hardware unit and the Soundcraft Vi-series consoles. Dual Optical SC-Plug (ISO/IEC 9314-3) connectors are provided.

(8) MADI OUT

Connect this port to the MADI optical input on the Soundcraft Vi console.

(9) MADI IN

Connect this port to the MADI optical output on the Soundcraft Vi console.

Standalone Behavior

Realtime Rack supports limited standalone functionality in the event that the Thunderbolt connection to the Mac host computer is lost, or if the Realtime Rack hardware unit is power cycled and no host computer is found upon re-powering the hardware.

Thunderbolt connection lost – In the event that the Thunderbolt cable is removed at one or both ends, or if the Mac host computer is otherwise no longer detected, Realtime Rack will continue to process audio in the same state as when the connection was lost, including UAD plug-in processing. If/when the host connection is reestablished, the Realtime Rack software will be updated to reflect the current state of the hardware, and software control is resumed.

***Important:** Reestablishing the Thunderbolt host-to-hardware connection will cause a temporary mute of the audio streams as channels and plug-ins are re-allocated. In the event of a mid-show failure, wait until it is acceptable to hear a mute in the audio path (e.g., not in the middle of a song).*

Power cycled, no host found – In the event that power to the Realtime Rack hardware unit is completely interrupted then reestablished and/or the unit is manually power cycled or reset, and the host computer cannot be detected after re-powering the hardware, Realtime Rack will function in “all MADI inputs to all MADI outputs” mode without UAD plug-in processing. This ensures that audio can still be routed by the Vi console, even if the Realtime Rack software connection cannot be established.

Chapter 3: System Setup

Overview

Realtime Rack system setup requires these primary procedures, all of which are detailed in this chapter:

- System connections (device wiring)
- Realtime Rack software installation
- Hardware device registration and UAD plug-in authorization
- Computer operating system software configuration
- Realtime Rack software configuration

System Requirements

- Realtime Rack hardware unit
- Apple Mac computer with available Thunderbolt 1 or 2 port
- macOS 10.11 El Capitan or 10.12 Sierra
- 4 gigabytes available disk space
- Internet connection to download software and authorize UAD plug-ins
- Apple Thunderbolt cable for each Realtime Rack unit (*not included*)
- (2) single MADI Optical SC cables or (1) Duplex MADI optical SC cable for each Realtime Rack unit (*not included*)
- Cat 5 Ethernet cable (*not included*)
- Apple Thunderbolt to Gigabit Ethernet Adapter (*not included*)

System Connections

Interconnect the Realtime Rack hardware unit, the Realtime Rack software host computer, and the Soundcraft Vi console using the illustrations in this section.

About Realtime Rack system connections

- Connect Realtime Rack to the host computer via Thunderbolt only. Do not connect to the host computer via 1394b ports.
- Although the Thunderbolt ports are numbered, the numbers are inconsequential and either port can be used.
- If available, the host computer's built-in Ethernet port can be used to connect to the Soundcraft Vi console instead of via the Apple Thunderbolt to Gigabit Ethernet Adapter (Apple part number MD463LL/A).
- Alternately, the Apple USB Ethernet Adapter (Apple part number MC704LL/A) can be used at the computer for the Ethernet connection (instead of the Thunderbolt to Gigabit Ethernet Adapter).
- The MADI channels to be processed by Realtime Rack are specified in the Hardware panel of the Settings page within the Realtime Rack software application.
- When synchronizing to external Word Clock, the first unit (MADI channels 1 – 16) must receive the Word Clock, then pass the clock to the second unit and so on (via daisy-chaining), for up to four units.

About Vi Console HiQNet (Ethernet) connections

- **Vi 1 consoles** – The HiQNet port is on the rear of the control surface, adjacent to the rear USB sockets (as shown at right).

Important: The HiQNet port on early Vi 1 consoles (serial numbers lower than 30210956) is only able to drive short cable lengths, maximum recommended length 1 meter (3 feet). Therefore use a network switch positioned close to the rear of the console to extend the cable length if required.

- **Vi 2, 4, and 6 consoles** – The HiQNet port is located on the rear of the Control Surface, adjacent to the MIDI ports (as shown at right). The port is capable of driving standard Ethernet distances of up to 100 meters.

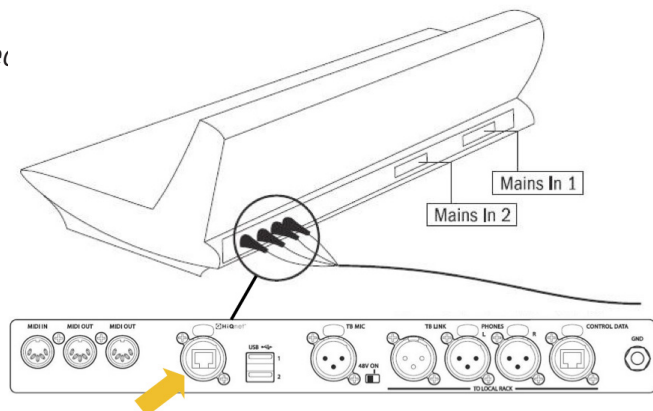
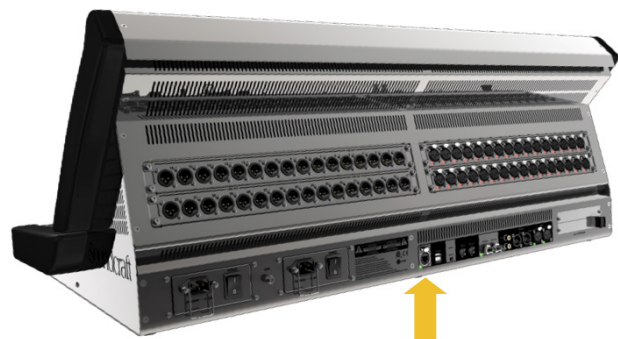

Single Unit Wiring

The diagram below illustrates connections for one Realtime Rack unit for up to 16 channels of UAD plug-in processing.

Cables Required (not included):

- One Thunderbolt cable between Realtime Rack and computer for software control
- Two MADI optical cables (or a single duplex cable) between Realtime Rack and Vi console for digital audio
- One Cat 5 Ethernet cable between host Mac and Vi console for snapshot control
- One Apple Thunderbolt to Gigabit Ethernet Adapter (Apple part number MD463LL/A) for Ethernet

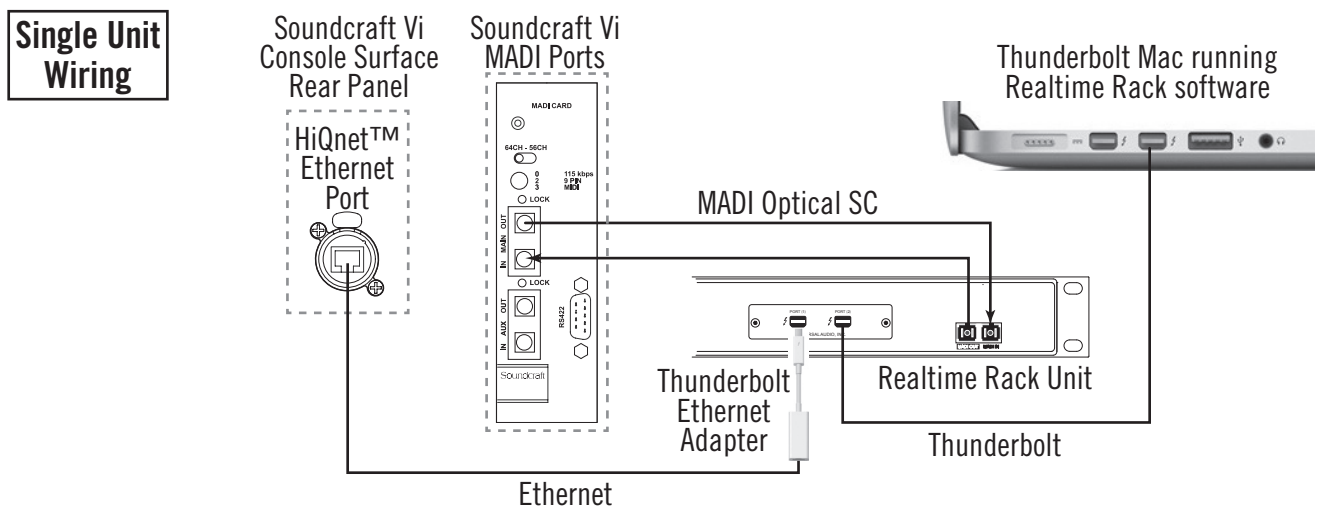

System interconnections for a single Realtime Rack setup

Multi-Unit Wiring

The diagram below illustrates connections for 2, 3, or 4 Realtime Rack units for up to 64 channels of UAD plug-in processing (16 MADi channels for each Realtime Rack unit).

Important: Multi-unit wiring in this section is newer than (and differs from) the "Getting Started" sheet that is included inside the retail box with early units.

Cables Required (not included):

- One Thunderbolt cable between Realtime Rack and computer for software control
- One Thunderbolt cable for each additional Realtime Rack for unit interlink
- One MADi optical cable between Vi console and the first Realtime Rack and for the digital audio send
- One MADi optical cable between the last Realtime Rack and Vi console for digital audio return
- One MADi optical cable for each additional Realtime Rack for unit interlink

Note: Duplex cables are not applicable with multi-unit configurations.

- One Cat 5 Ethernet cable between host Mac and Vi console for snapshot control
- One Apple Thunderbolt to Gigabit Ethernet Adapter (Apple part number MD463LL/A) for Ethernet

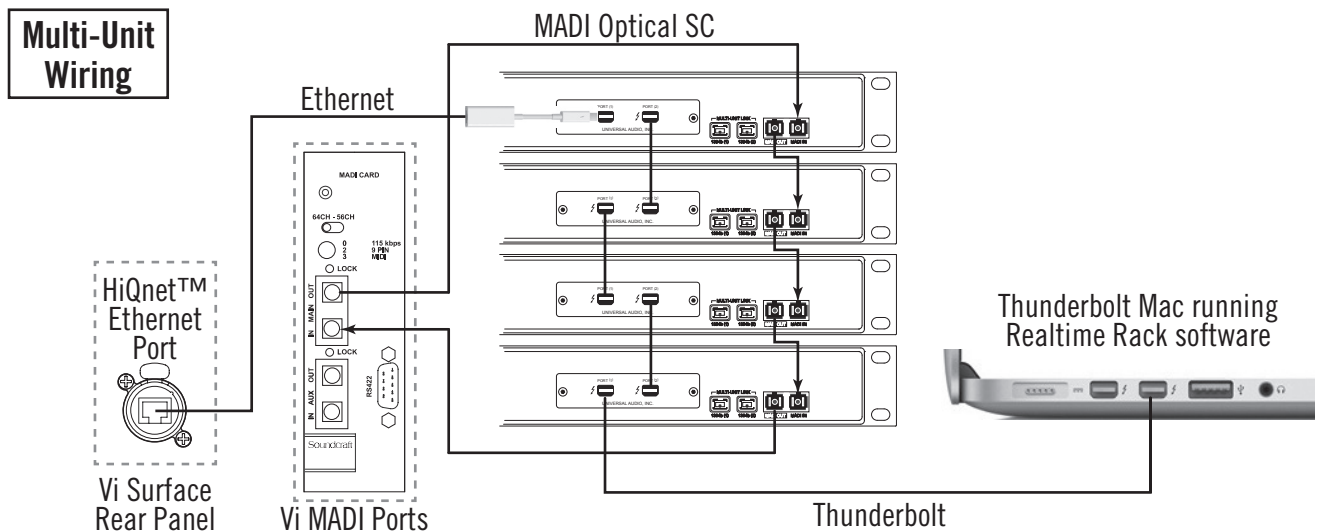

System interconnections for a multi-unit Realtime Rack setup

Software Installation

Complete Realtime Rack software installation consists of two main steps:

- Realtime Rack software installation
- Device registration and UAD plug-in authorization

Preparation

Close all open files and applications before starting the software installation procedure. The installer requires a restart after installation.

If you are updating to a newer version of Realtime Rack software or installing additional Realtime Rack hardware units, it is not necessary to remove the previous Realtime Rack software or hardware from the system before software installation.

Software Installation Procedure

To install the Realtime Rack software and UAD plug-ins:

1. Verify the Realtime Rack hardware unit is powered and connected to the host computer via Thunderbolt.
2. Download the Realtime Rack software installer from:
www.uaudio.com/realtimerack/start
3. Open the downloaded installer application. The installer will guide you.



Note: If prompted to update the firmware, see "About Firmware Updates" below.

4. Restart the computer when prompted. Software installation is complete.
5. Proceed to [Device Registration & Authorization on page 30](#).

About Firmware Updates

- Firmware updates for the Realtime Rack hardware may be included within the software to enhance system functionality. The Realtime Rack software prompts for firmware updates automatically (if available). For optimum results, always update the firmware by clicking "OK" if prompted by the software.
- After "OK" is clicked and the firmware is installed, a notification appears. After the notification, power off the Realtime Rack hardware. The first time power is reapplied, the hardware will take an extra 20–30 seconds to initialize, after which the firmware update process is complete.

Important: Do not interrupt system power during the firmware update routine.

Device Registration & Authorization

The Realtime Rack hardware unit must be registered and authorized at my.uaudio.com to unlock UAD plug-ins that are bundled with the product. Registration only needs to be completed once. However, authorization must be completed each time the Realtime Rack software is updated.

About Registration

Realtime Rack device registration is triggered automatically as part of the initial authorization process. The first time authorization is initiated, the default web browser launches and connects to the UA store. Follow the instructions on the web pages to create an account, register the hardware, claim bundled UAD plug-ins, and authorize the system.

About Authorization

The Realtime Rack hardware stores its authorization and UAD plug-in licenses in the device itself, so the unit can be connected to a different computer without repeating the authorization process. UAD plug-ins that were not bundled with the product can be evaluated without functional restriction during a [Demo Mode](#) that expires after 14 days.

Authorization Procedure

Before proceeding, confirm that the Realtime Rack software is has already been installed and the Realtime Rack hardware is powered and connected to the computer via Thunderbolt (the hardware and software systems must be communicating properly).

Important: *The following procedure requires an Internet connection to the host computer. To authorize a system that is not connected to the Internet, see the [Offline Authorization Procedure](#) on page 31.*

To authorize Realtime Rack and UAD plug-ins:

1. Launch the UAD Meter & Control Panel. To open the application, click its icon (shown at right) in the Mac OS X Dock.
2. Open the Plug-Ins panel within the UAD Meter & Control Panel application. To access the panel, click the blue UAD-2 button in the UAD Meter window.

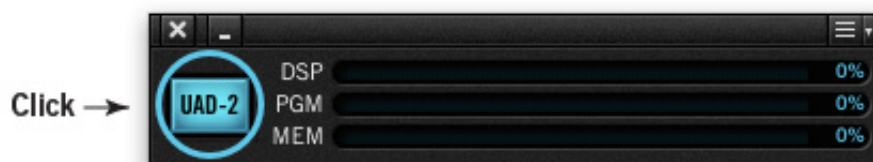

3. Click the “Authorize Plug-Ins...” button in the Plug-Ins panel. The software connects to the Universal Audio authorization servers.

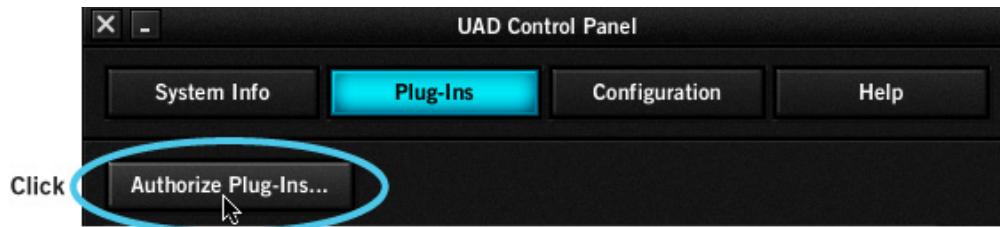

4. After a few moments, the Authorization Status window appears and "Authorizations successfully updated" is displayed. Click OK to close the window.

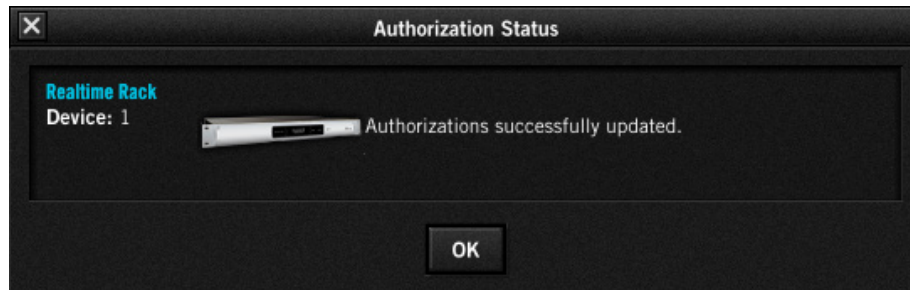

5. System authorization is complete. Proceed to [Operating System Software Configuration on page 33](#).

Offline Authorization Procedure

If the Realtime Rack computer is not connected to the Internet, you will need to manually transfer the registration URL into the browser of a web-enabled computer, download the authorization file on the web computer, then transfer the authorization file back to the Realtime Rack computer.

Important: *If the Realtime Rack computer is not connected to the internet, you must manually transfer the **exact** registration URL into the browser of a web-enabled computer.*

To authorize a system that is not connected to the Internet:

1. Install the Realtime Rack software and hardware using the procedures detailed earlier in this chapter. The Realtime Rack hardware must be powered on and the system must be communicating properly.
2. Launch the UAD Meter & Control Panel application, open the Plug-Ins Panel, and click the "Authorize Plug-Ins" button by following step numbers 1, 2, and 3 on [page 30](#). The default web browser opens with the registration URL in the address bar, along with an error that the computer is not connected to the Internet.

(continued)

3. You must enter this URL in a web-connected computer, so either:
 - a. Drag the URL icon in the browser's address bar to the Desktop to create a weblink shortcut (preferred, as illustrated below) then transfer the weblink shortcut to the internet computer via a storage device or network, OR
 - b. Carefully write down the URL, EXACTLY as it appears in the address field.

1. Click+Hold URL icon in browser address bar



2. Drag URL icon to Desktop or flash drive to create a link shortcut

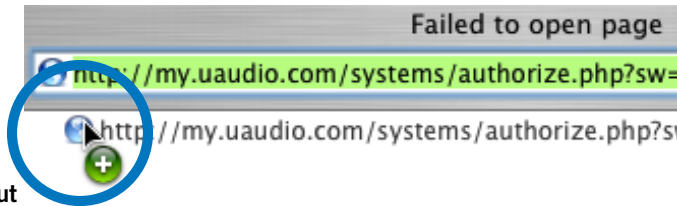

Creating a web location shortcut file on the offline system for easier transfer of the URL to an online computer

4. Go to the URL using a web browser on an Internet-connected computer. Either double-click the transferred weblink shortcut, or enter the URL as previously noted.
 - If you don't already have a [My.Uaudio](#) account, you are directed to create one. Follow the instructions online.
 - If you already have a My.Uaudio account, login with your email address and password. If your password is lost, the store can email a new one to you.
5. The Realtime Rack hardware is automatically registered and added to your [My Systems](#) group, and your authorization file is generated.
6. The authorization file named "auth.uad2" should begin downloading automatically (if not, click the download authorization link).
7. Transfer the authorization file to the Realtime Rack computer via a storage device or network.
8. Double-click the authorization file on the Realtime Rack computer. The authorization is loaded onto the Realtime Rack unit(s) and after a few seconds the Authorizations Status window appears. Offline registration and authorization is complete.
9. Proceed to [Operating System Software Configuration on page 33](#).

Operating System Software Configuration

Before using Realtime Rack, specific settings must be made in the Mac OS X System Preferences>Energy Saver panel.

Mac OS X System Preferences

The System Preferences application can be accessed from the Apple Menu (under the Apple icon at the upper left of the OS X Menu Bar), or via the file system at:

- /Applications/Utilities/System Preferences.app

Energy Saver Panel

The required settings are in the Energy Saver panel within System Preferences. To access the panel, click its icon or name in the main System Preferences window.

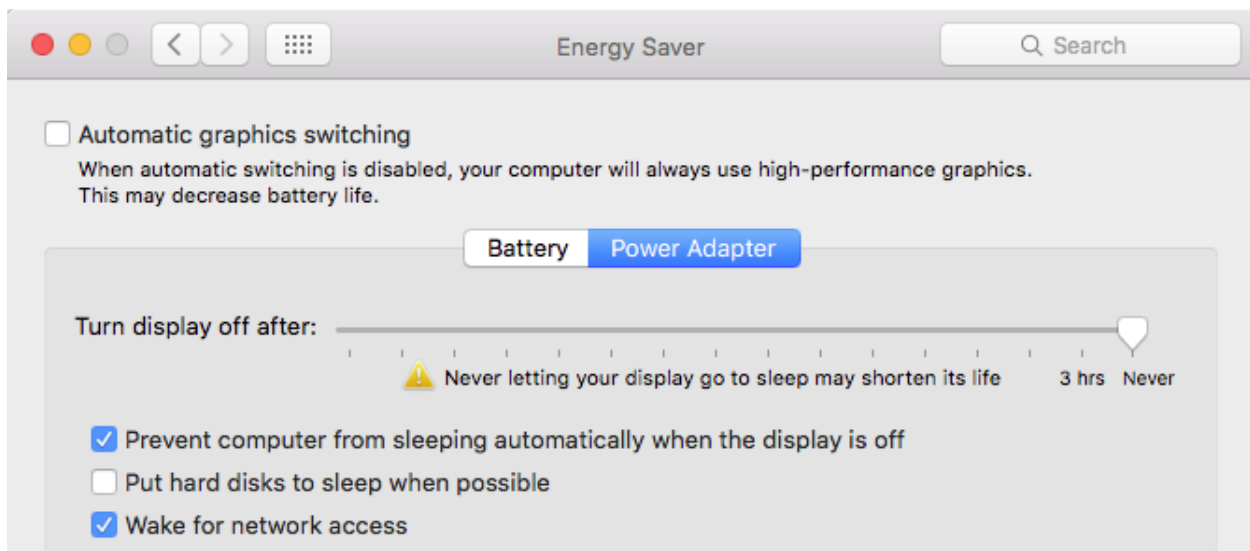

The required Mac OS X system settings for Realtime Rack operation

Computer Sleep

In the Power Adapter tab, enable the "Prevent computer from sleeping automatically when the display is off" option.

Display Sleep

In the Power Adapter tab, set display sleep to "Never" by dragging the "Turn display off after" slider to the far right position.

Although display sleep is benign to the system, disabling display sleep is recommended to prevent the issuing of inadvertent mouse/keyboard clicks that could send potentially destructive commands to the Realtime Rack software.

Hard Disk Sleep

In the Power Adapter tab, disable the "Put hard disks to sleep when possible" option to ensure consistent computer performance.

Wake for network access

In the Power Adapter tab, enable the "Wake for network access" option.

Soundcraft Vi Series consoles require "Wake for network access" to be enabled on Mac OS X in order to prevent losing the communication link between the Mac running Realtime Rack and the Soundcraft Vi console if/when the Mac enters Sleep mode.

Important: *If this setting is disabled and the computer enters System Sleep (either intentionally or unintentionally), the Mac will require system restart or a disconnect/reconnect of the Thunderbolt cable to recover after waking from sleep.*

Power Adapter Tab

The Energy Saver panel has "Battery" and "Power Adapter" tabs for setting different Sleep settings when the computer is running on the power adapter versus running on internal battery power.

Realtime Rack is fully qualified only when the Mac is connected to a power source. However, it is important to ensure that Sleep is deactivated (as described above) in the Battery tab in the event of an accidental power disconnection.

Important: *Realtime Rack is qualified when the computer is running on AC power, and using Realtime Rack with battery power is not a supported configuration. When using a portable notebook computer such as a MacBook Pro or MacBook Air, use the included power adapter for optimum results.*

Battery Tab

Note: *Although battery operation is not supported with Realtime Rack, make these settings in the Battery tab in case the power adapter is inadvertently disconnected.*

- Set display sleep to "Never" by dragging the "Turn display off after" slider to the far right position.
- Disable the "Put hard disks to sleep when possible" option to ensure consistent computer performance.

Operating system configuration is complete. Proceed to [Realtime Rack Software Configuration on page 35](#).

Realtime Rack Software Configuration

To properly communicate with the hardware, software settings within the Realtime Rack application must be configured for the Realtime Rack system.

To configure the system settings:

1. Confirm that the Realtime Rack hardware is properly connected and powered.
2. Launch the Realtime Rack software. Open the application by clicking its icon (shown at right) in the Mac OS X Dock. The software opens and fills the screen.
3. Click the View menu in the upper left corner (INSERTS is displayed here by default) and select SETTINGS from the drop menu. The HARDWARE tab, containing the system settings, is displayed.



Sample Rate

4. From the SAMPLE RATE drop menu, set the sample rate to 48 kHz to match the Soundcraft Vi console system sample rate.

Clock Source

5. From the CLOCK SOURCE drop menu, specify the system clock to be used for digital audio synchronization. This setting is usually set to MADI (except when using external Word Clock).

MADI Bank

6. From the MADI CHANNELS drop menu, specify the 16-channel MADI bank to be processed by Realtime Rack. This setting should match the channels specified in the Soundcraft Vi console.
7. If multiple Realtime Rack units are connected concurrently, they are automatically assigned to the next set of 16 MADI channel banks. To change the order and processing bank used by Realtime Rack, drag and drop the [Unit Buttons](#) up or down until they are in the correct order. Use the [Identify Unit Buttons](#) to identify the current assignments of each unit.

Note: The physical MADI cable ordering must match the ordering set with the [Unit Buttons](#).

After the procedures detailed in this chapter are completed for system connections, software installation, registration, authorization, operating system configuration, and application configuration, the Realtime Rack system is ready for use.

Chapter 4: Realtime Rack Application

Application Overview

The Realtime Rack software application is the software interface for the Realtime Rack hardware. The application is used to configure the Realtime Rack hardware and control UAD Powered Plug-Ins. It can control up to four hardware units concurrently. All application operations are detailed in this chapter.

***Note:** In this chapter, “Realtime Rack” refers to the software application (not the hardware unit) unless specifically noted otherwise.*

Concepts

Realtime Rack is optimized for operation in environments where fast navigation and operation are paramount.

The general concept of Realtime Rack’s navigation is a “focus channel” workflow where the operator has a birds-eye view of everything occurring in the application, with the ability to quickly navigate to different channels in order to focus on a channel and edit the various parameters.

Once a channel is focused (selected), the various controls and features can be edited, such as any of the eight individual plug-in inserts per channel, plug-in assignments, input/output gains, track names, presets, and more. Parameters, presets, and assignments for individual plug-ins can be edited, or Channel Strip view can be used to control multiple plug-ins concurrently.

***Note:** Although UAD plug-ins are operated within the application, all signal processing occurs on the SHARC DSPs in the hardware unit(s), not the host computer’s CPU.*

View Screens

Realtime Rack has six primary screens called *Views*. Each View displays related visual and control elements. Items available within each View can vary depending on the active selection or function.

Some Views provide a broader overview of the environment (e.g., Inserts View), while others facilitate deep editing of individual functions (e.g., Channel View) and/or file management (e.g., Snapshots View). Various shortcuts exist for quickly switching between the six View screens.

Global Displays

Items that facilitate navigation and visual feedback that is crucial in performance environments are always displayed in the *Meter Bridge* and *Info Bar*. Banks of channels and individual channels can be quickly navigated with the *Bank Bar* and *Channels Bar* to quickly get to a channel for editing.

Navigation

Navigation within the application possible with minimal mouse and/or keyboard motions, and menus are generally only used for less common operations (e.g., global settings).

The application is designed to take extensive advantage of navigation using the computer's QWERTY keyboard for precise operations and to reduce targeting errors.

Keyboard Focus

When elements on the screen have keyboard focus, they can be manipulated with the QWERTY keyboard. Keyboard focus in Realtime Rack is indicated by a yellow outline box around the screen elements targeted for control with the QWERTY keyboard. These highlighted items can typically be manipulated by using the up/down/left/right arrow keys and/or the Return/Enter keys.

Edit & Safe Modes

To reduce the possibility of inadvertent results, Realtime Rack has two operating modes. Operations that can cause significant impact to the audio (such as level changes) can only be performed in Edit mode, while Safe mode is (typically) used during performance to prevent inadvertent changes.

Important: *Realtime Rack does not have an Undo function. Operations performed in Edit mode can only be reverted by loading previously-saved presets and/or Snapshots.*

Offline Configuration

The application can be configured without connected rack units for offline setup and/or sharing the hardware with other operators. Additionally, import and export functions are provided to simplify transporting user data between different Realtime Rack systems and/or operators.

Entering & Exiting the Application

Important: To communicate with the Realtime Rack hardware, software settings within the computer and the application must be properly configured. For details, see [“Chapter 3: System Setup” beginning on page 25](#).

Launch

Realtime Rack can be opened using either of these methods:



- Single-click the Realtime Rack icon that was placed in the Mac OS X Dock during software installation, or
- Double-click the Realtime Rack application that was installed to: `/Applications/Universal Audio/`

Full Screen Display

When Realtime Rack is launched, the application expands to fill the entire screen (it cannot be re-sized). The application does not have a standard Mac OS X Menu Bar at the top of the screen.

Note: Unlike most Mac OS X applications in full screen mode, there is no option to show a menu bar when the mouse is moved to the top of the screen.

Multiple Display Operation

Multiple display screens are supported. With multiple-display systems, when the Monitors preference is set to ALL, the screen on each display can have different View screen so more elements can be displayed concurrently. For details, see [“Monitors Menu” on page 115](#).

Hide/Switch

Realtime Rack can be used concurrently with other Mac OS X applications.

- To hide the application so other applications can be seen, use the standard Mac OS X keyboard shortcut (Command+H).
- To bring Realtime Rack back into the foreground, when it is hidden, click its icon in the OS X Dock or use the Command+Tab application switching shortcut.
- To bring other running applications to the foreground, use the standard Mac OS X keyboard shortcut for application switching (Command+Tab).

Quit

Realtime Rack can be closed using either of these methods:

- Select Quit from the application’s View menu (upper left by default), or
- Use the standard Mac OS X keyboard shortcut (Command+Q)

Realtime Rack Terms

For the purpose of describing Realtime Rack operations in this chapter, the following definitions are used.

Screen – All elements currently visible on the computer display. Some displayed elements are common to all screens, while other elements depend on the active View and/or selected function.

Element – One specific item in the screen. An element can be a menu, control (button, switch, knob), or visual indicator. Some screen elements vary depending on the active view and the functions available within that view.

View – A set of related functions. Realtime Rack has six primary views, and some views have multiple screens. Items available within each view can vary depending on the active function.

Tab – A button that switches between a set of elements within a view.

Channel – A single MADi channel within the 64-channel MADi stream. Each Realtime Rack unit can process up to 16 MADi channels.

Plug-In – The UAD plug-in files containing the DSP algorithms. Each plug-in has a unique interface containing a set of controls that adjust its audio processing features.

Insert – A slot within a single channel where plug-ins are loaded and adjusted. Each channel has eight inserts to facilitate serial processing.

Channel Strip – Two or more UAD plug-ins inserted serially in the same channel for stacked signal processing.

Bank – A group of MADi channels that are displayed concurrently. The number of channels displayed in a Realtime Rack bank can range from four to 64 channels.

Group – A set of specific channels that are grouped together. Realtime Rack uses groups for latency delay compensation, which is necessary to align channels that must maintain phase coherency (such as drum kits with multiple microphones).

Linked – Two adjacent channels that are combined into a stereo pair. Linked channels operate with one set of controls and pan settings are automatically set to hard left/right.

Focus – A control element that is selected and ready to accept an operational command. Realtime Rack uses element focus extensively to enable operation with the computer's QWERTY keyboard.

Preset – A complete set of parameter values for an individual plug-in or channel strip that are saved as a named disk file. Presets are used to recall favorite settings for individual plug-ins and/or channel strips.







Snapshot – A complete Realtime Rack configuration. Snapshots contain all parameter values within the Realtime Rack application and are used to for total session recall. Snapshots can be loaded directly from within the Soundcraft Vi console via Ethernet using the Vi CUE functions.

Navigation Overview

This section provides an introduction to the various screen elements and navigational concepts. Items in this section are explained in greater detail later in this chapter.

Views Overview

Realtime Rack has six primary screens called *Views*. Each View displays related visual and control elements. The currently selected View can be identified by the icon displayed at the top of the [Main Column](#). Views can be selected from the [View Menu](#). Each View name, its associated icon, and a brief description is below. Complete details for each View are provided later in this chapter.

 Inserts	Displays banks of channels and all plug-in inserts within the current bank. Inserts View is used to move, copy, and paste plug-ins and channels strips, and their current settings, amongst the available inserts in the bank.
 Gains	Displays channel input/output gain controls and signal I/O level meters for all channels within the Current Bank. Channels can also be stereo linked/unlinked in this view.
 Delay Groups	Displays and assigns delay (latency) compensation groups, and latency values, for all channels within the Current Bank.
 Channel	Displays plug-ins and channel strips within individual channels. Channel View is used for editing plug-in parameters and managing presets for individual and/or stacked plug-ins.
 Snapshots	Displays a file management page to store, recall, and edit snapshots of entire Realtime Rack configurations.
 Settings	Displays multiple tabs for setting various hardware, display, MIDI, and plug-in settings and preferences.

Global Navigation Elements

The Main Column, Meter Bridge, Channels Bar, and Info Bar can all be used to navigate to different View screens. The location of these elements are illustrated below.

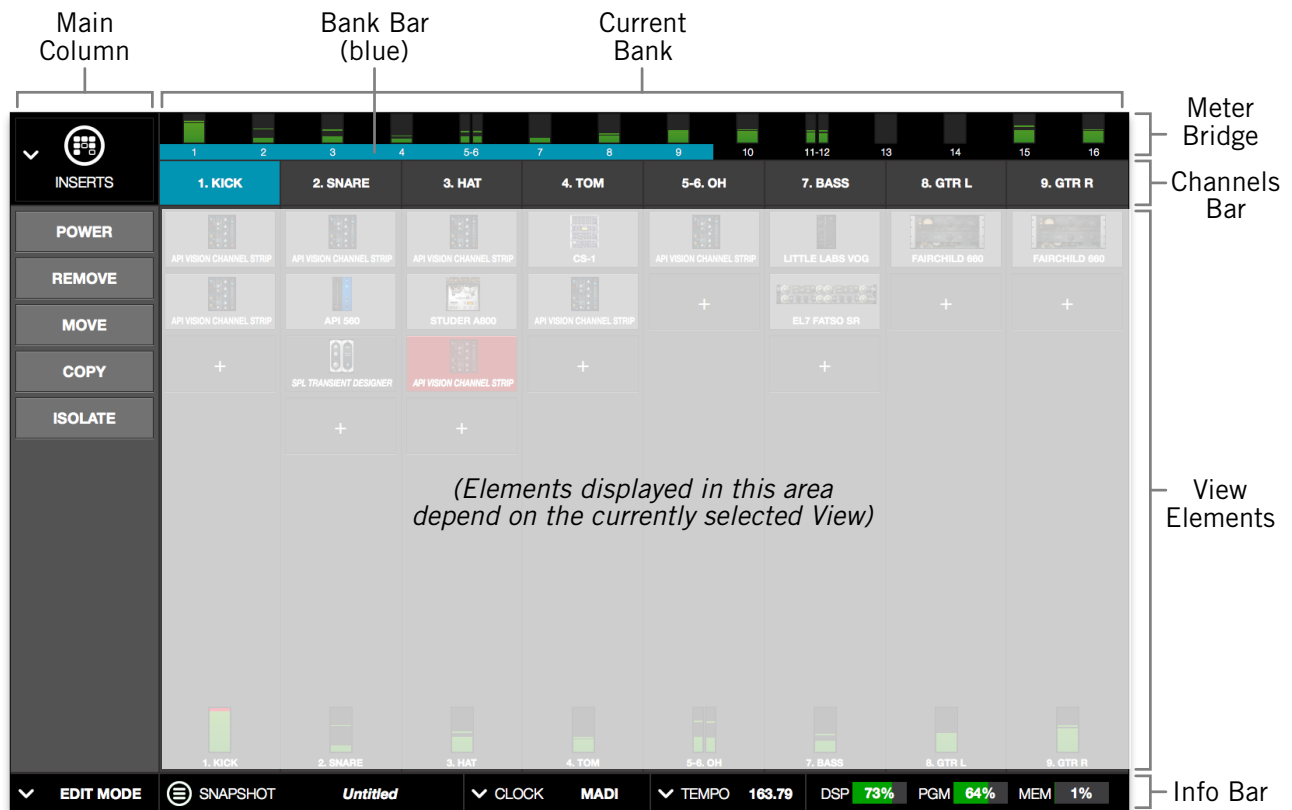

The global elements that appear on all Realtime Rack screens

Info Bar

The Info Bar is always displayed in all screens, providing visual feedback and access to options that are important in performance environments. Navigate to Snapshots View by clicking the SNAPSHOT area.

Main Column

The Main Column is used to choose the current View and navigate available options within the View. The Main Column contains the View Menu and the View Options.

In the illustration at right, Inserts View is currently active. This is indicated by the INSERTS icon and title at the top of the Main Column.

The View Options shown here are the options available in Inserts View. These options are different for each active View.

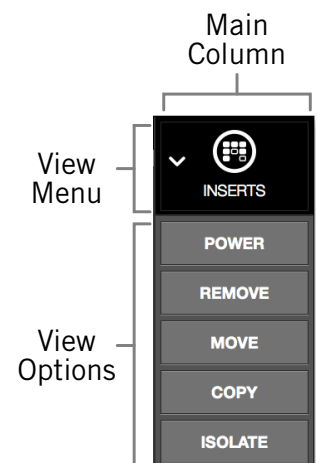

View Menu

To access any View screen, click the View Menu at the top of the Main Column, and select a View from the drop menu, as shown at right.

View Options

The View Options are buttons used to activate various control functions within each View. The View Options displayed are contextual; the options change when a different View is selected.

Bank Views

Bank Views are Views that display multiple channels at once. Inserts, Gains, and Delay Groups are the three Bank Views. The Bank Views are grouped within the View Menu (they are not separated by a divider line).

Tip: On any screen, single-click the Meter Bridge to quickly return to the last selected Bank View.

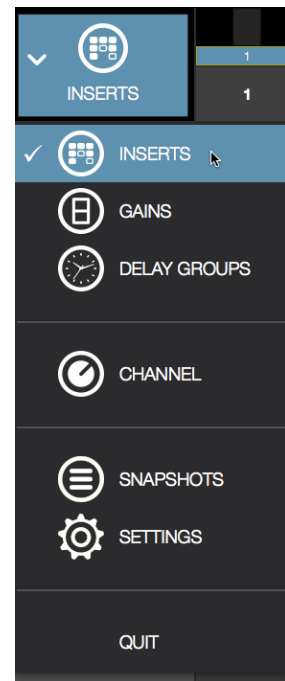

The View Menu

Channels Bar

The Channels Bar is used for channel navigation and to quickly select channels for editing.

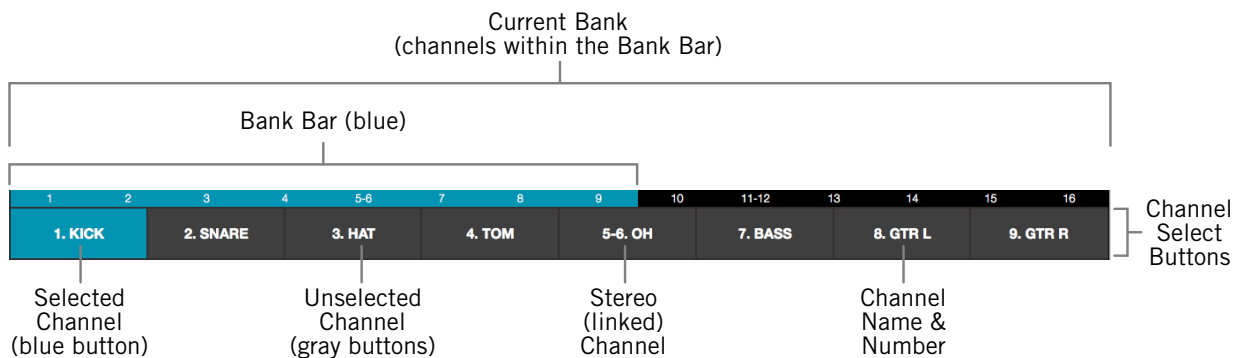

The Channels Bar elements as displayed with a Bank Size of 8 channels

Channel Select Buttons

The Channel Select buttons represent all Current Bank channels. The Channel Select buttons are displayed in all [Bank Views](#) (Inserts, Gains, and Delay Groups).

The Channel Select buttons can be used to quickly navigate any Current Bank channel into Channel View for loading, editing, and saving plug-in settings.

Banks

A fundamental navigational concept in Realtime Rack is the *Bank*. A Bank is a subset of all available MADl channels. Channels contained within a [Current Bank](#) are represented by the [Channel Select Buttons](#) in the [Channels Bar](#) and the [Bank Bar](#).

Current Bank

The Current Bank is all the channels displayed in the Channels Bar. Channels contained within the Current Bank are represented by the Channel Select buttons and the thin blue Bank Bar.

The Current Bank is changed with the Bank Bar. The number of Current Bank channels can be changed with the Bank Size setting.

Bank Size

The number of channels displayed simultaneously in the Current Bank is determined by the Bank Size setting, which is set in View Menu>Settings>Display Tab>BANK SIZE.

Bank Bar

The thin blue Bank Bar visually represents all channels in the [Current Bank](#). The Bank Bar is used for Current Bank navigation within all View screens.

Bank Bar Navigation

The Bank Bar is used to change the Current Bank. Any of the following methods can be used to navigate available channels:

- **Drag** – Drag the Bank Bar, or anywhere in the Input Meters area, with the mouse to change the current bank. With this method, the current bank can be shifted by one or more channels.
- **Click Input Meter** – Single click any channel's green input meter to switch directly to the bank that contains the channel. With this method, the number of channels shifted is determined by the BANK SIZE setting.
- **Arrow keys** – When the Bank Bar has keyboard focus, use the left/right arrow keys to shift the current bank. With this method, the number of channels shifted is determined by the BANK SIZE setting.

Bank Concept



*Conceptual illustration of a Bank within Realtime Rack.
In this example, the Current Bank is channels 4 through 11.
Moving the thin blue Bank Bar changes the Current Bank channels.*

Meter Bridge

The Meter Bridge is always displayed across the top of all screens. The Meter Bridge contains Input Meters for all MADI channels in the system. Several navigation shortcuts are available from the Meter Bridge.

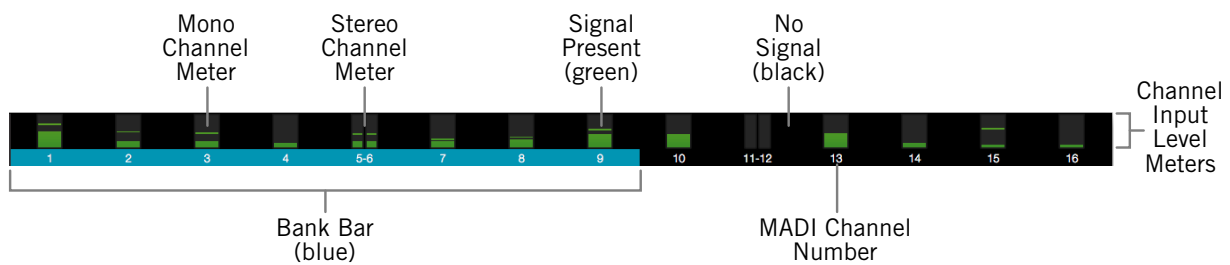

The Meter Bridge elements as displayed with a 16-channel (single unit) system

Input Meters

Each vertical green meter indicates input signals that are present in the associated MADI channel. The Meter Bridge contains several shortcuts to navigate Realtime Rack, as listed below.

Meter Bridge Navigation

The Meter Bridge can be used as navigation shortcuts for the functions below:

- **Jump to any channel** – Double-click any channel’s Input Meter in the Meter Bridge to jump directly to Channel View and select the channel.

To return to Bank View:

- **Return to Bank View** – Single-click anywhere in the Input Meters area to return to the previously selected Bank View (Inserts, Gains, or Delay Groups).

Navigation Scroll Bars

Realtime Rack software displays vertical and horizontal scroll bars when needed in various views. Scroll bars are used for navigation in the following areas:

- **Channel View / Single view mode** – For horizontal and/or vertical scrolling of a plug-in interface that is too large for the current screen resolution to display.
- **Channel View / Channel Strip view mode** – For horizontal and/or vertical scrolling of a Channel Strip that is too large for the current screen resolution to display
- **All list views** – Plug-in presets, channel presets, assign, snapshots, and settings/ plug-ins tab – For vertical scrolling of all files/folders in the current list view.



Typical navigation scroll bars, shown here outlined in red, as they appear with a typical plug-in interface and in the Snapshots list

Keyboard Focus

When elements on the screen have keyboard focus, they can be manipulated with the QWERTY keyboard. Keyboard focus in Realtime Rack is indicated by a yellow outline box around the screen elements targeted for control with the QWERTY keyboard. These highlighted items can typically be manipulated by using the up/down/left/right arrow keys and/or the Return/Enter keys.

When elements on the screen have keyboard focus, they can be manipulated with the QWERTY keyboard. Focused items can typically be manipulated by using the up/down/left/right arrow keys and/or the Return/Enter keys.

Focus Indication

Keyboard focus in is indicated by a yellow outline box around screen elements targeted for control with the QWERTY keyboard.

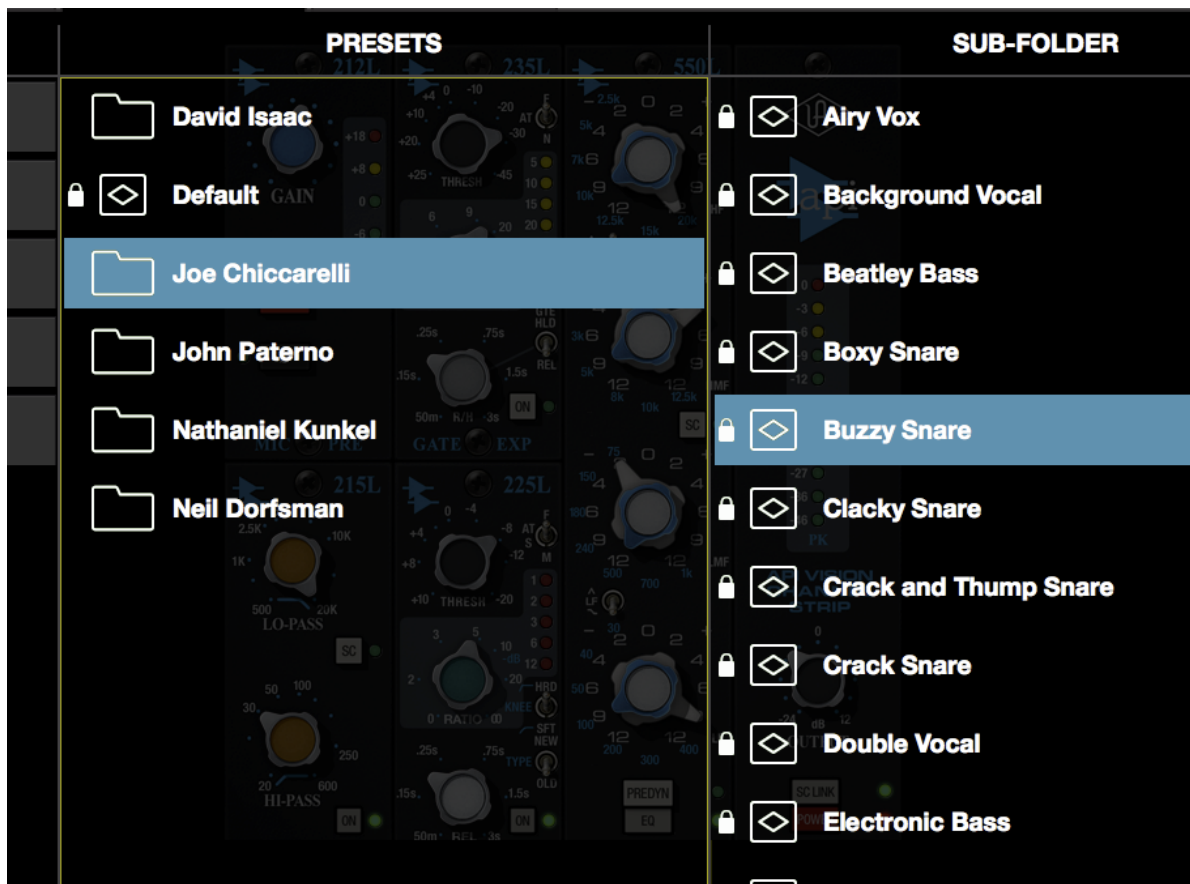

Typical focus indication. In this example, the PRESETS folder column on the left has focus (yellow outline) and can be navigated with the up/down arrow keys on the keyboard. The tab key will shift focus between this column and the SUB-FOLDER column.

Focus Navigation

Focus between elements can be changed with the computer's TAB key, or by clicking another area of the screen with the mouse.

Keyboard Shortcuts

In addition to keyboard focus/navigation methods, Realtime Rack supports the keyboard shortcuts listed in the table below.

Shortcut Name	Keyboard Command	Description
Save Snapshot	COMMAND+S	Saves the current snapshot in place
Save Snapshot As...	COMMAND+SHIFT+S	Saves the current snapshot as a new snapshot and allows renaming
Hide Application	COMMAND+H	Hides the application from view
Quit Application	COMMAND+Q	Quits the Realtime Rack application
Show Previous View*	COMMAND+LEFT ARROW	Returns to the previous view
Show Next View*	COMMAND+RIGHT ARROW	Returns to the next view
Tab Focus Navigation	TAB	Cycles through various sections of the app that can be focused/controlled/navigated with the arrow keys
Cancel dialog overlay	ESC (escape)	Used to cancel dialog functions like Save As, Tap Tempo, enter Edit Mode, etc.
Confirm dialog overlay	RETURN or ENTER	Used to accept dialog overlays like Save As, Tap Tempo, enter Edit Mode, etc.
Channel Navigation	UP/DOWN/LEFT/RIGHT RETURN/ENTER	Used to navigate through all channels and functions that can be focused and executed
<i>*Previous/Next only shows Views displayed since application was opened</i>		

Important: Realtime Rack does not have an Undo function. Operations performed in Edit mode can only be reverted by loading previously-saved presets and/or Snapshots.

Global Screen Elements

The Main Column, Current Bank, Meter Bridge, Channel Bar, and Info Bar are groups of elements appear on all screens. These global elements are described in this section.

Refer to the illustration below for descriptions in this section.

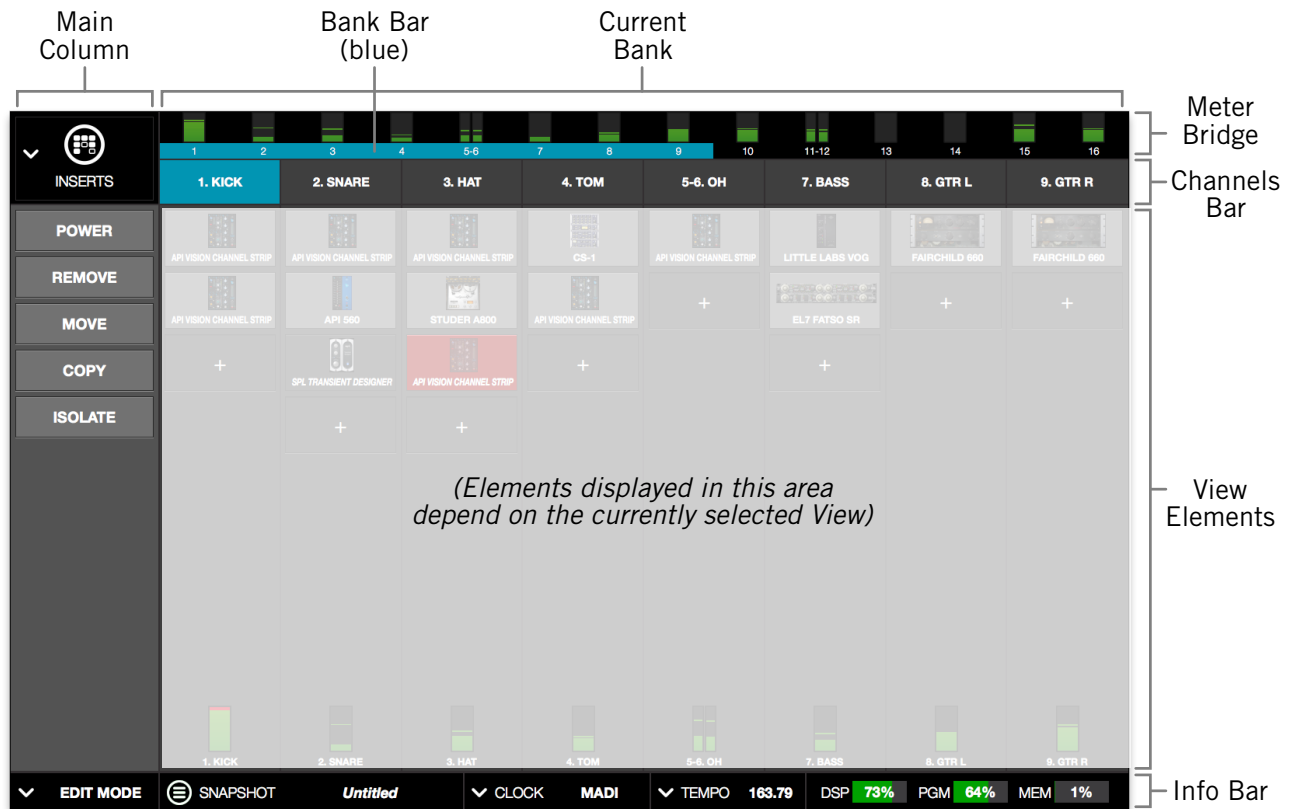

The global elements that appear on all Realtime Rack screens

View Elements

The View elements that appear in the main area of each View screen (items not within the Main Column, Meter Bridge, Channels Bar, or Info Bar) depend on the View that is currently selected. All View elements are described in the View sections later in this chapter.

Main Column

The Main Column is used to choose the current View and navigate available options within the View. The Main Column contains the View Menu and the View Options, as shown at right.

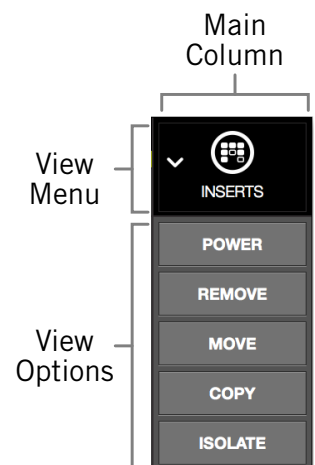

View Menu

The six main Views can be accessed with the View Menu. To access any View, click the View Menu at the top of the Main Column, and select a View from the drop menu, as shown at right.

View Options

The View Options are buttons used to activate various control functions within each View. The View Options displayed are contextual; the options change when a different View is selected.

Bank Views

Bank Views are Views that display multiple channels at once. Inserts, Gains, and Delay Groups are the three Bank Views. The Bank Views are grouped within the View Menu; they are not separated by a divider line.

Tip: On any screen, click the Meter Bridge to quickly return to the last selected Bank View.

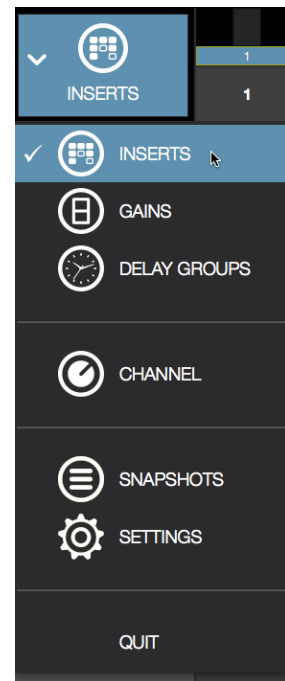

The View Menu

Quit

At the bottom of the View Menu is the QUIT option. Choose QUIT to close the application. The Command+Q keyboard shortcut can also be used to quit.

Column Placement

By default, the Main Column is at the left side of all screens. However, its placement can be moved to the right side of all screens, by setting the preference at View Menu>Settings>Display Tab>COLUMN LOCATION.

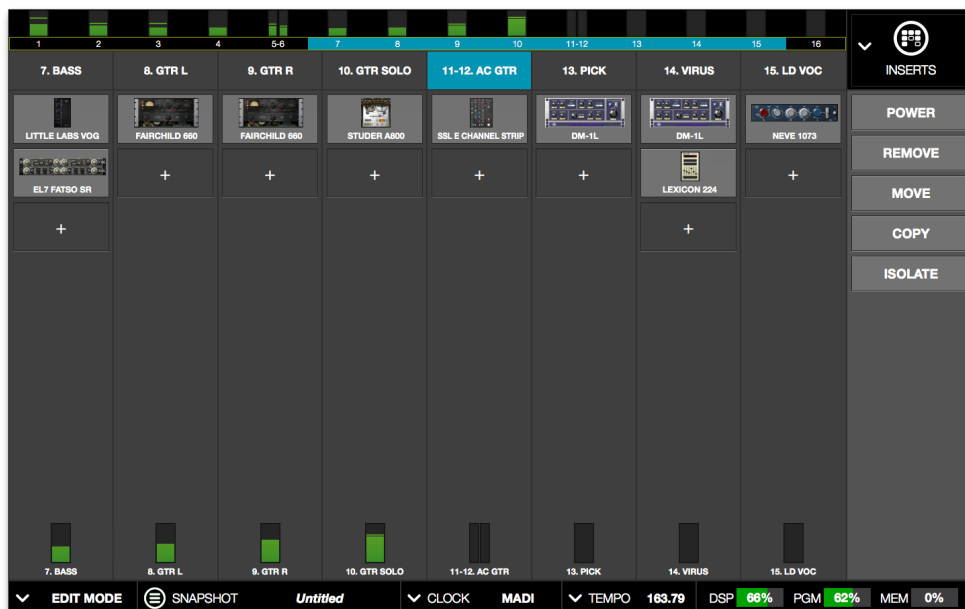

The Main Column as it appears when positioned on the right side of the screen

Meter Bridge

The Meter Bridge is always displayed across the top of all screens. The Meter Bridge contains Input Meters for all MADi channels in the system and can be used for navigation within Realtime Rack.

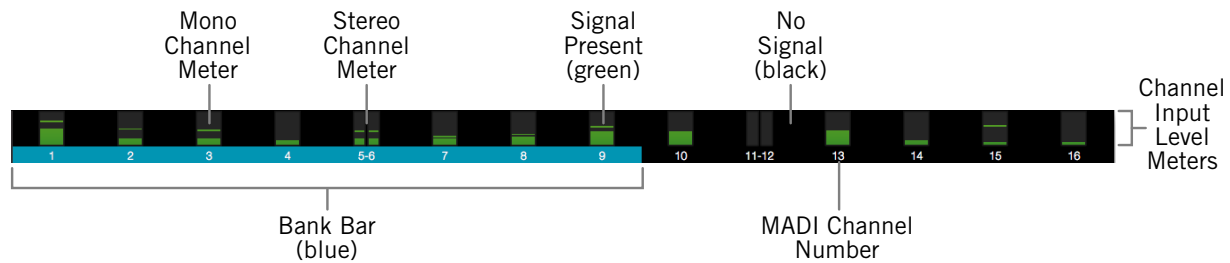

The Meter Bridge elements as displayed with a 16-channel (single unit) system

Input Meters

Each vertical green meter indicates input signals that are present in the associated MADi channel. The Meter Bridge automatically expands to display additional MADi channels when two, three, and/or four Realtime Rack hardware units are connected to the system.

Tip: Single-click the input meters to enter the most recently selected bank view.

Additional (empty) MADi channels can be manually added to the Meter Bridge by clicking the “+” button at View Menu>Settings>Hardware Tab. This provision is typically used to add empty MADi channels so offline setups can be configured.

Mono/Stereo

A dual/split meter indicates two channels are stereo linked. When a dual/split meter is shown, the meter represents the left and right channels of the stereo signal.

Bank Bar

The blue Bank Bar visually represents all channels in the [Current Bank](#). The Bank Bar is used for Current Bank navigation within all View screens. For details, see [page 52](#).

Meter Bridge Navigation

The Meter Bridge can be used as shortcuts for the functions below:

- **Jump to any channel** – Double click any channel’s Input Meter in the Meter Bridge to jump directly to Channel View and select the channel.

To return to Bank View:

- **Return to Bank View** – Single click anywhere in the Input Meters area to return to the previously selected [Bank View](#) (Inserts, Gains, or Delay Groups).

Channels Bar

The Channels Bar is used for channel navigation and to quickly select channels for editing. Refer to the illustration below for descriptions in this section.

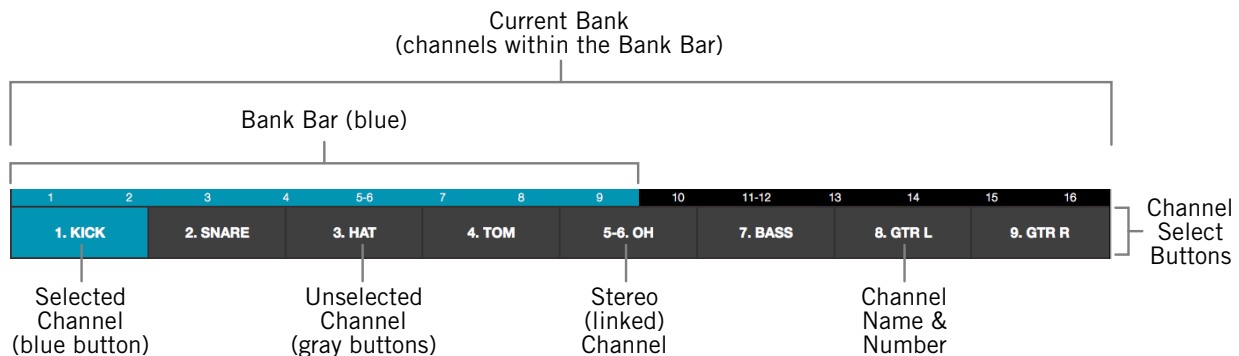

The Channels Bar elements as displayed with a Bank Size of 8 channels

Current Bank

The Current Bank is a subset of all available MAD1 channels. Channels contained within the Current Bank are represented by the Channel Select buttons and the thin blue Bank Bar.

The Current Bank is changed with the [Bank Bar](#). The number of Current Bank channels can be changed via the Bank Size setting.

Bank Size

The number of channels displayed simultaneously in the Current Bank is determined by the Bank Size preference, which is set in View Menu>Settings>Display Tab>BANK SIZE.

Channel Select Buttons

The Channel Select buttons represent all Current Bank channels. The Channel Select buttons are displayed in all [Bank Views](#) (Inserts, Gains, and Delay Groups).

The Channel Select buttons can be used to quickly put any Current Bank channel into Channel View for loading, editing, and saving plug-in settings.

Tip: Single-click any bank channel select button to enter Channel View and select the channel for plug-in editing.

Channel Number & Name

The channel number and name is displayed in each Channel Select button. If no channel name has been entered, only the channel number is displayed. The channel number cannot be modified.

Channels are named in Channel View by clicking the channel's [Channel Name Button](#) within the Main Column, then entering a name in the name field that appears.

Selected Channel

The currently selected channel within the Current Bank is highlighted by a blue Channel Select button. Functions in Channel View are always performed on the selected channel.

Bank Bar

The blue Bank Bar represents all channels in the [Current Bank](#). The Bank Bar is used for Current Bank navigation within all View screens.

Bank Navigation

The Bank Bar is used to change the Current Bank. Any of the following methods can be used to navigate available channels:

- **Drag** – Drag the Bank Bar, or anywhere in the Input Meters area, with the mouse to change the current bank. With this method, the current bank can be shifted by one or more channels.
- **Click Input Meter** – Single click any channel's green input meter to switch directly to the bank that contains the channel. With this method, the number of channels shifted is determined by the BANK SIZE setting.
- **Arrow keys** – When the Bank Bar has keyboard focus, use the left/right arrow keys to shift the current bank. With this method, the number of channels shifted is determined by the BANK SIZE setting.

Info Bar

The Info Bar is always displayed in all screens, providing visual information and access to options that are critical in performance environments.

Refer to the illustration below for all Info Bar descriptions in this section.

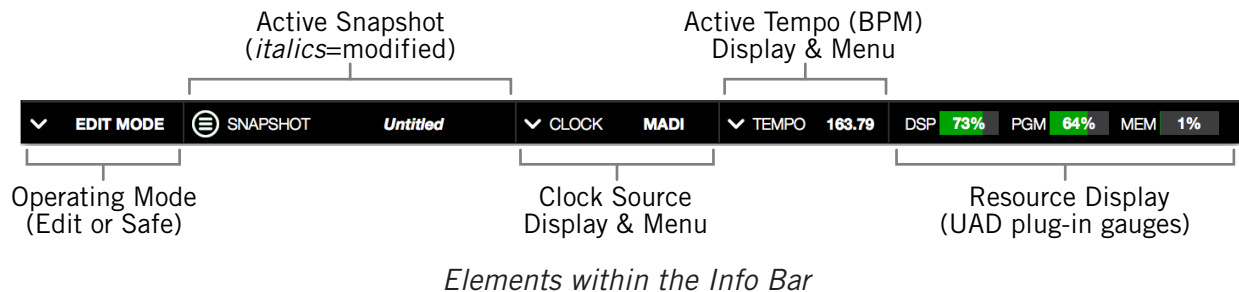

The Tempo and Operating Mode controls can only be accessed via the Info Bar. All other controls are also available elsewhere in the application. The Resource Display has no controls (it is a visual indicator only).

Info Bar Placement

By default, the Info Bar is at the bottom of all screens. However, its placement can be moved to the top of all screens, by setting the preference at View Menu>Settings>Display Tab>INFO LOCATION.

Info Bar Elements

The Info Bar contains the five main elements below. All elements are described in greater detail later in this section.

- **Operating Mode** – Displays the active Operating Mode (either EDIT or SAFE). Click this area to switch modes.
- **Active Snapshot** – Displays the Active Snapshot name. If the snapshot has been modified since it was loaded, the name is displayed in *italics*. If the Snapshot was loaded via a Soundcraft Vi Console, the name is “[SOUNDCRAFT CUE].”

Tip: Click this area to switch to Snapshots View to load and/or save Snapshots.

- **Clock Source** – Displays the active clock source (MADI, Word Clock, or Internal). Click this area to select a different clock source from the drop menu. This area flashes red if the currently selected clock is not detected (when digital audio is not synchronized).
- **Active Tempo** – Displays the tempo, in beats per minute (BPM), used by UAD plug-ins that are set to use Tempo Sync. Click this area to enter or tap a different tempo.
- **Resource Meters** – Displays resource loads used by UAD plug-ins. This allows you to monitor UAD loads as needed, for example when deciding which UAD plug-ins to load, based upon how much DSP is available.

Operating Mode

Realtime Rack has two switched operating modes: EDIT and SAFE.

EDIT Mode

Edit mode is typically used for setup and configuration. Edit mode allows all functionality, no matter how potentially destructive, to be executed.

Ideally, settings that can only be modified in Edit mode are used before a live performance to minimize the risk of level changes, clicks/pops, or other audio artifacts that could occur with some operations.

SAFE Mode

Specific parameters and/or functionality are inactive or disabled in Safe mode. This mode is typically used during live performance to prevent inadvertent changes that could significantly impact the audio. See the table on [page 55](#) for the specific Safe mode constraints.

Operating Mode Display

The active Operating Mode is displayed at the far left of the Info Bar. The appearance of each active mode is shown at right.



***Note:** The Info Bar is the only area within Realtime Rack where the Operating Mode can be viewed or changed.*



Changing the active operating mode

To switch the active operating mode, single click anywhere in the Operating Mode display element at the left of the Info Bar. Execution occurs as follows:

- **Edit mode to Safe mode** – When EDIT mode is active, clicking the operating mode display instantly switches Realtime Rack into Safe mode.
- **Safe mode to Edit mode** – When SAFE mode is active, clicking the operating mode area presents a confirmation dialog to prevent inadvertent mode switching. Click OK in the dialog to confirm the change and enter Edit mode.

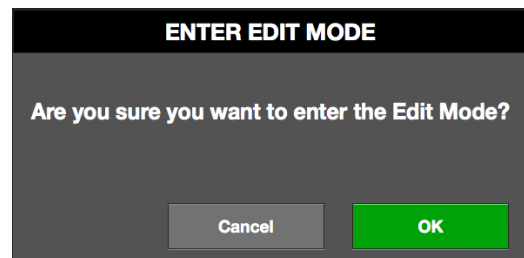

Safe Mode Constraints

View screen operations that cannot be executed in Safe mode are detailed in the table below.

Caution: When Safe mode is active, Snapshots can still be recalled, which can potentially overwrite current plug-in assignments and cause audio artifacts during live a performance.

View Screen	SAFE Mode Constraint
INSERTS	<ul style="list-style-type: none">• Plug-in REMOVE, MOVE, and COPY/PASTE modifiers are hidden• Empty plug-in inserts are hidden• ASSIGN mode is disabled
GAINS	<ul style="list-style-type: none">• Stereo LINK/UNLINK buttons are hidden
DELAY GROUPS	<ul style="list-style-type: none">• Latency compensation engine cannot be modified (existing settings persist)• Delay Group buttons are hidden (existing groups persist)
CHANNEL	<ul style="list-style-type: none">• Channel ASSIGN tab is hidden• Plug-ins cannot be added or removed• Channel PRESETS tab is hidden (when in Channel Strip mode)• New Channel Strip presets cannot be added or removed
SETTINGS	<ul style="list-style-type: none">• Sample Rate, Clock Source, and MADI Channels cannot be modified
INFO BAR	<ul style="list-style-type: none">• Clock Source cannot be modified

Snapshot Display

The Snapshot Display shows the filename of the Active Snapshot.



A Snapshot is a complete Realtime Rack configuration file, containing all parameter values within the application. Snapshots are typically used for total session recall. Snapshots can also be recalled directly within the Soundcraft Vi console via Ethernet.

Italic Snapshot Name

Whenever the active snapshot is modified from its last saved state, the Snapshot name is displayed in *italics*, as shown at right.



Tip: Type *Command+S* at any time to save the current state of the existing Snapshot to disk (overwriting the existing file; note this operation cannot be undone), or type *Shift+Command+S* to save the Snapshot as a new disk file.

Soundcraft CUE Name

When a Snapshot is loaded remotely from a Soundcraft Vi Console (via Ethernet), the Active Snapshot is overwritten. When this occurs, [SOUNDCRAFT CUE] is displayed, as shown at right.



Caution: When a Snapshot CUE is loaded from a Soundcraft Vi Console, the Active Snapshot is overwritten, any unsaved changes are lost, and audio artifacts could occur.

Clock Display

The Clock Display has three functions: It shows the currently selected clock source, facilitates selection of a different clock source, and indicates when the selected clock source signal is not detected.



Clock Source Menu

Realtme Rack can synchronize to external MADI clock, external word clock, or Internal clock. To select a clock source, click anywhere in the clock display area to view the clock source pop-up menu (shown at right), then select a clock source from the menu.

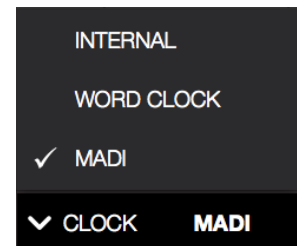

Tip: The clock source can also be specified in View Menu>Settings>Hardware Tab>CLOCK SOURCE.

In typical use, Realtme Rack should be set to MADI clock (the default value) for synchronization with the digital audio from/to the Soundcraft Vi console.

Note: The Clock Source cannot be modified in SAFE mode.

No External Clock

If the Clock Source setting is not set to Internal and the external clock signal cannot be detected and/or resolved, then the text in the Clock Display display flashes RED (shown at right) until a valid clock is detected and/or an alternate clock source is selected. If this occurs, verify connections and external device settings.



Important: Only one device in a digital audio system can be the master clock source. The Realtme Rack clock setting, and the sample rate, must match the MADI device settings or audio artifacts could occur.

No Hardware Detected

If the Realtme Rack hardware unit(s) is not properly connected and/or the software is not properly installed, the clock source will display OFFLINE as shown at right.



Tempo Display

This area displays the tempo value of the Active Snapshot in BPM (beats per minute) and facilitates selection of a different tempo.

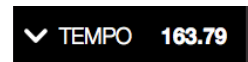

The tempo value is used by time-based UAD plug-ins (such as delays and echos) that are set to use their Tempo Sync features. For details about how to use UAD plug-ins with this feature, see [“Tempo Sync” on page 137](#).

The Tempo value is stored within the Snapshot; therefore each Snapshot can contain a unique tempo. The available tempo range is from 1.00 BPM to 999.00 BPM. The default tempo of a new Snapshot is 120 BPM.

Changing tempo values within the tempo dialog

The tempo can be changed within the tempo dialog by entering a text value or using the tap tempo feature.

To view the tempo dialog (shown at right), click anywhere in the Tempo Display within the Info Bar.

Tip: To leave the tempo unchanged after entering an (unwanted) value in the dialog, press the ESC key or click Cancel with the mouse.

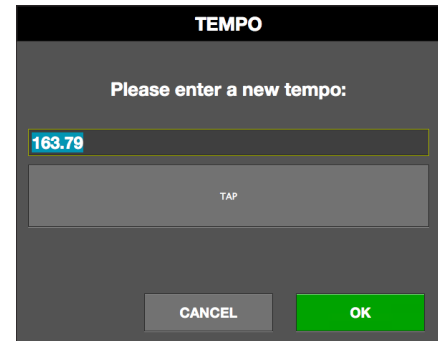

Text Entry

1. Open the tempo dialog by clicking the tempo display in the Info Bar
2. Type a numeric tempo value
3. Press Return or Enter, or click OK with the mouse.

Tap Tempo: QWERTY keyboard

1. Open the tempo dialog by clicking the tempo display in the Info Bar
2. Press the Tab key once to focus the TAP button (yellow outline)
3. Press the “t” key at least four times to establish the tempo
4. Press Return or Enter.

Tap Tempo: Mouse

1. Open the tempo dialog by clicking the tempo display in the Info Bar
2. With the mouse, click the TAP button at least four times to establish the tempo
3. Click the OK button.

Changing tempo values via MIDI

Tap tempo can be used to set a new tempo from incoming MIDI that are received via the Mac OS X operating system. This method requires any external MIDI hardware and/or MIDI software that is recognized by Audio MIDI Setup (which is Mac OS X's MIDI routing utility application (located in /Applications/Utilities)).

About external MIDI tap tempo control

- Audio MIDI Setup must be configured before Realtime Rack is launched. After it is properly configured, Audio MIDI Setup does not need to remain open.
- MIDI note values or MIDI controller values can be used as the data source.
- Realtime Rack cannot synchronize the tempo to incoming MIDI beat clock.

MIDI configuration/setup

1. Before Realtime Rack is opened, verify the MIDI output device and/or MIDI software is configured properly and active in Audio MIDI Setup.
2. In the View Menu>Settings>MIDI Tab ([page 115](#)), set the values for MIDI DEVICE, MIDI CHANNEL, DATA TYPE, and DATA VALUE to match the transmitted MIDI data.
3. Transmit the MIDI note or controller (as specified in the previous step) at least four times to establish the tempo. The Tempo Display is RED during this period.
4. After a new tempo value is established, the new tempo is used and the Tempo Display changes back to BLACK. Simply retransmit the MIDI data to apply further tempo updates.

Resource Display

UAD plug-in loads are shown in the Resource Display at the far right of the Info Bar. These three meters (DSP, PGM, and MEM) provide important visual feedback in realtime, by helping to determine which plug-ins to load if available UAD resources are limited.

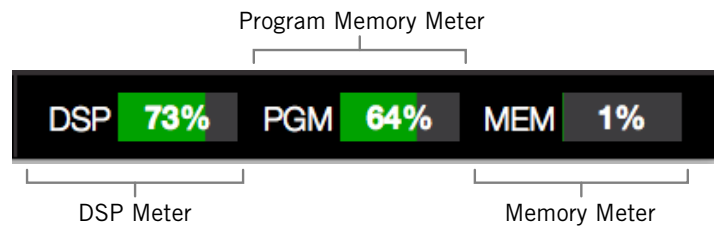

The Resource Display within the Info Bar

The Resource Display mirrors the meters within the UAD Meter & Control Panel application. The details provided in this section is a subset of more complete explanations that are available in [“Chapter 5: UAD Meter & Control Panel” beginning on page 120](#).

UAD Resource Loads

The green bar graph of each meter, and its percentage, represent the amount of the resource that is currently used. 100% is the maximum possible load.

Averaged Loads

The load for each meter represents the average for all UAD devices in use. For example, if one Realtime Rack hardware unit is installed, the DSP load is an average of the four SHARC DSP processors in the unit. If two units are installed, then the loads of all eight processors are averaged.

Channel Loads

All UAD plug-ins in a single channel must fit on a single DSP. Therefore it is possible to get a “plug-in was unable to load” message when attempting load a plug-in or in a channel that does not have enough UAD resources, even if the Resource Display indicates enough overall resources are available.

Static Loads

Realtime Rack uses UAD DSP and memory for its internal DSP mixer, therefore the meters will indicate loads (when the hardware is connected) even if UAD plug-ins are not loaded.

Individual Device Loads

The loads of individual devices in a multi-unit setup, and the individual DSP loads within a single unit) can be viewed in the System Information panel within the UAD Meter & Control Panel application.

UAD Plug-Ins Loads

The amount of UAD resources used by UAD plug-ins vary with each individual plug-in; more complex algorithms require more resources.

The amount of DSP used by each individual UAD plug-in is available in the UAD instance count chart. The chart can help determine which to plug-ins to assign with available resources. The chart is published online at:

- www.uaudio.com/support/uad/compatibility/instance-chart.html

DSP

The DSP meter displays the amount of digital signal processing resources that are being used by Realtime Rack. DSP is the primary hardware resource that powers the UAD Powered Plug-In algorithms.

***Note:** When UAD plug-ins are disabled, DSP requirements are decreased EXCEPT when the plug-in is disabled using the Power control within the plug-in interface.*

Program

This resource shows how much program memory (PGM) is in use. Program memory is an on-chip memory that is specific to the SHARC processor(s) and is used for certain UAD plug-in resources.

Each unique UAD plug-in uses a bit of program memory. If many different plug-ins are loaded simultaneously, it is possible for this resource to run out before a DSP overload occurs. This point is considered and factored in by automatic load balancing routines.

Memory

The Memory (MEM) meters indicate the amount of Realtime Rack hardware RAM that is currently in use.

Memory is used for echo, delay lines, reverb, and similar spatial processing. When UAD plug-ins are disabled but not unloaded, memory requirements are not decreased. In this case, the memory remains loaded so that reverb tails and delay lines are not cut off when the plug-in is disabled.

Inserts View

Inserts View displays an overview of the current state of all inserts within all channels within the Current Bank. An insert is a single slot, within a single channel, where UAD plug-ins are instantiated.

This view is where plug-ins can be very rapidly disabled, moved, removed, copied, and isolated using the Inserts Options. All Inserts View functions are detailed in this section.

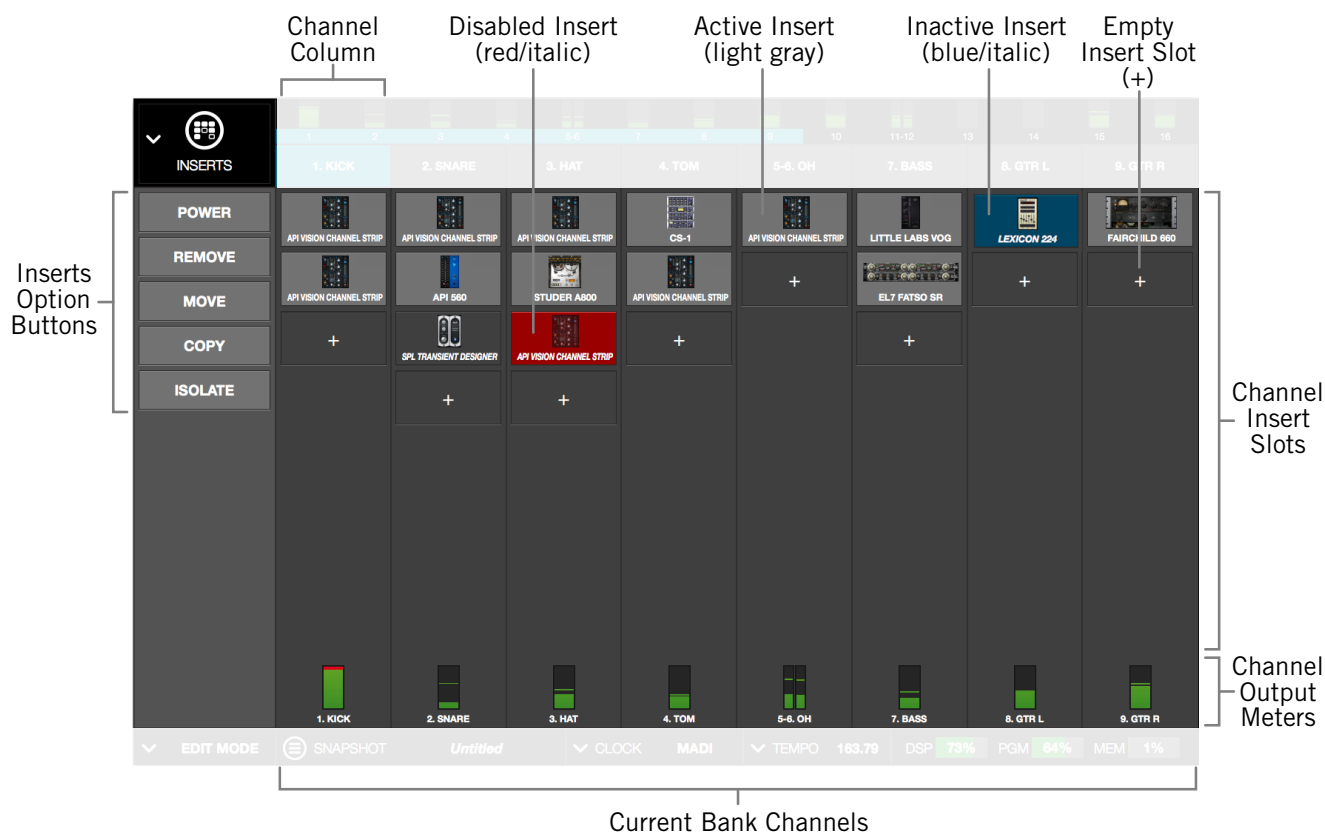

Above: The main elements within Inserts View

Inserts View is one of the three [Bank Views](#). If Inserts View is active then a non-Bank View (Channel, Snapshots, or Settings) is activated, single-clicking the input meters in the Meter Bridge will return to Inserts View.

Current Bank Channels

Inserts View displays all channels in the Current Bank. The Current Bank is defined by, and navigated with, the blue [Bank Bar](#) within the [Meter Bridge](#).

Tip: To change the active bank channels, focus the Bank Bar via the Tab key then use the left/right arrow keys, or drag the Bank Bar with the mouse.

Bank Size

The total number of channels displayed concurrently in the active bank is a preference specified in View Menu>Settings>Display Tab>BANK SIZE.

Channel Column

The channel column provides an overview of the plug-in state of a single channel, and all channels in the bank are displayed concurrently. All UAD plug-ins loaded in the channel are displayed here, along with an output meter for the channel.

***Note:** The number of displayed channel columns is defined by the bank size setting in Settings View.*

Insert Slots

The insert slots indicate the current status of each plug-in, and provide a shortcut to Channel View, where the individual plug-ins are manipulated. Up to eight slots are available within each channel to facilitate serial signal processing.

***Tip:** Click anywhere in any empty column space to jump to Channel View for assigning and editing plug-ins in the slot.*

Channel Signal Flow

Audio signals in a channel flow through the inserts serially from top to bottom. Therefore, if more than one plug-in is inserted in a channel, the location of a plug-in within the inserts can impact the sound of the channel. Inserts can be [re-ordered in Channels View](#) to change the serial processing order.

State Indication

Populated insert slots contain a thumbnail image of the UAD plug-in that is loaded in the slot. The state of loaded plug-ins within each insert slot can be determined by the background color of the slot, as follows:

Active (light gray) – The plug-in is active and processing audio.

Inactive (dark blue) – The plug-in has been disabled by the power button in Channel View, and the plug-in name is italicized (the EMT 140 slot at right indicates this state).

***Note:** Disabling a plug-in via the power control within its GUI interface (versus the Power button in Channel View) does not change the background color or italicize the name.*

Disabled (red) – The plug-in is disabled because there is not enough UAD resources, it is unlicensed and the demo has expired, and/or the UAD authorization needs updating. The plug-in name is also italicized. The EP-34 slot at right indicates this state.

Empty (+) – The slot is not populated with a plug-in. Click the "+" symbol to switch to Channel View and insert a plug-in into the slot.

***Tip:** Click anywhere in any empty column space to insert a plug-in at that location.*



Channel column with populated insert slots

Output Meter – This meter displays the signal level at the output of the channel (after all plug-in processing in the channel).

Inserts Options Overview

The Inserts Options (in the Main Column, below the View Menu) enable various operations to be performed on the plug-ins displayed within Inserts View.

The option operations are accomplished by selecting an option to latch the function, executing the operation(s) using Modifiers, then exiting the latched function.

Option Latch



When an Inserts Option button is activated, the button flashes blue, indicating that the function is latched and ready to be executed.

Option Unlatch

The latched option is unlatched (the button stops flashing blue) when:

- Any option button is activated (same or different)
- A different View screen is activated
- No operations are executed during the Timeout Length

Timeout Length

When an option is latched, it is automatically unlatched (times out) after the Timeout Length to prevent inadvertent modifications. The Timeout Length is a preference set in View Menu>Settings>Display Tab>TIMEOUT LENGTH. The default Timeout Length is six seconds.

Modifiers

Modifiers are icons superimposed on various elements when an option is latched. Modifiers are used to execute the operations. The specific modifiers that appear, and where they are located, depend upon the specific option that is latched.

Inserts modifiers are superimposed on insert slots, and smaller column modifiers are superimposed on the Channel Select buttons within the [Channels Bar](#), as shown in the next screenshot.

Modifier Swipe Shortcuts

Modifier functions can be executed extremely rapidly across many channels and/or insert slots in the current bank using the swipe shortcuts. When an Insert Option is latched, click+hold the mouse, then drag vertically and/or horizontally across channels and/or inserts to perform the function on all inserts that are swiped.

***Tip:** The Modifier swipe shortcuts are (by far) the fastest way to perform the same function on multiple inserts (for example, as compared to equivalent functions in Channel View).*

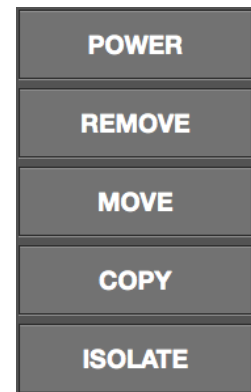

The Inserts Options buttons

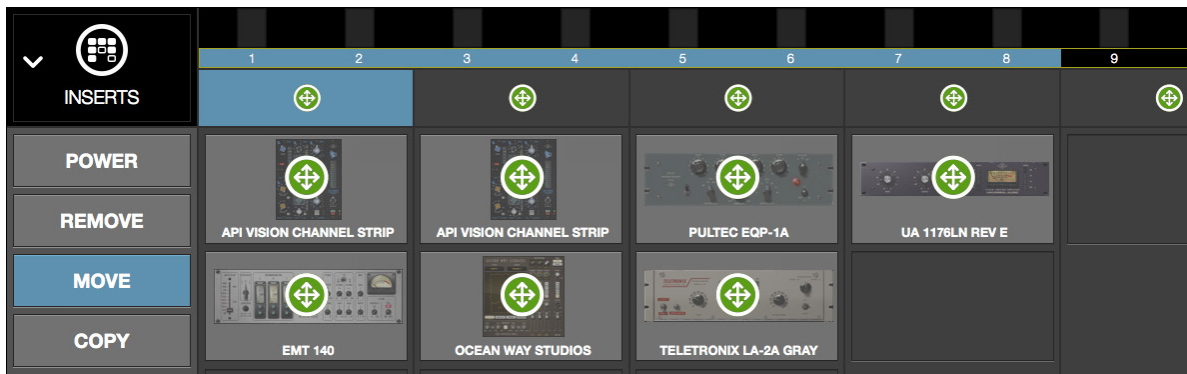

Inserts View showing the modifiers that appear when the move option is latched. Swipe across channels and/or insert slots to rapidly perform the function on many inserts.

Inserts Option Descriptions

The functions of each Insert Option are detailed below. The descriptions and screenshots are applicable when the option button is latched (blue).

Note: All UAD plug-ins within a single channel must fit on a single DSP. Therefore it is possible to get a “plug-in was unable to load” message when attempting to move or paste a plug-in or channel strip to a channel that does not have enough UAD resources, even if the Resource Display indicates enough overall resources are available.

Most Inserts Options are only available in EDIT mode. The Power and Isolate options are available in SAFE mode.

Important: Insert Option operations cannot be undone.

Power

The Power option deactivates an individual plug-in within a single insert slot. When deactivated, the plug-in no longer uses UAD DSP resources. Click the modifier to change the power state.

When Power is latched, deactivated plug-ins are indicated by a red modifier, and active plug-ins have a green modifier.



Caution: Because this function unloads and loads the plug-in from the DSP, audio artifacts can occur if the power state is changed while audio is being processed by the plug-in. To disable individual plug-in processing without audio artifacts, use the power control within the plug-in interface in Channel View instead (however, the interface control method does not reduce DSP loads).

Remove

The Remove option permanently deletes the plug-in from the insert slot. When Remove is latched, click the modifier to delete the plug-in.

Important: If the plug-in settings are modified and unsaved in a preset, the modified settings are lost with this function (Remove cannot be undone).



Caution: Because this function unloads the plug-in from the DSP, audio artifacts can occur if a plug-in is removed while audio is being processed by the plug-in.

Move

The Move option is used to move an individual plug-in (and its active settings) from one insert slot to another insert slot in any channel within the Current Bank.

Move can also be used to move a complete channel strip (all plug-ins in the channel column) from one channel to another channel within the Current Bank.

Move Individual Plug-In

When Move is latched, drag any insert modifier to move the plug-in to another slot. If a plug-in exists in the destination slot, the existing plug-in is bumped to a different slot within the same channel.

Move Channel Strip within same bank

When Move is latched, drag any column modifier to another channel to move the all plug-ins in the source column to the destination column.

Caution: If plug-ins exist in the destination channel, all existing plug-ins in the destination channel are deleted. Move operations cannot be undone.



Copy

The Copy option is used to duplicate an individual plug-in or complete channel strip, and their active settings.

Copy can be performed from one insert slot to another insert slot (on the same or a different channel), or from one channel to another channel, within the Current Bank.

Note: To copy settings to a channel that is not within the current bank, use the channels presets function available within Channel View.

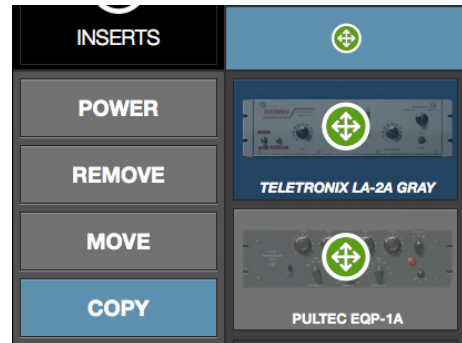

Copy is a two step process. First the insert or channel strip is copied, then the copied data is pasted to the destination insert or channel.

Tip: After copying, the copied modifier remains superimposed on the source element, as an indicator of the data that resides in the copy/paste buffer.

Paste

After any insert or channel strip is copied, the Copy button changes to Paste. To paste the copied data, click any insert slot and the copied data is placed in the destination. The copied data can be pasted to multiple destinations as long as the paste option remains latched.

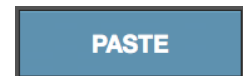

Caution: If plug-in or channel strip exists in the paste destination(s), existing plug-ins or channel strips in the destination(s) are deleted. Paste operations cannot be undone.

Copy Individual Plug-In

When Copy is latched, click any insert modifier to copy the plug-in, then click one or more destinations while the paste button is latched.

Copy Channel Strip

When Copy is latched, click any column modifier to copy the channel strip, then click one or more bank channel select buttons while the paste button is latched.

Note: When copying channel strips, the channel's input and output gain settings are also copied/pasted to maintain consistent signal levels.

Isolate

Isolate prevents a channel's active settings from being modified when a Snapshot (a Realtime Rack configuration file) is loaded.

Isolate is typically used to prevent channel adjustments made during a live performance from being overwritten by Snapshot changes.

When Isolate is latched, click any column modifier to isolate the channel. Click again to de-isolate the channel.

When a channel is isolated, the text “[ISO]” appears beneath the bank channel name in the Meter Bridge.

Tip: Channel isolations can also be set in Gains View.



The Isolate modifiers and text indication

Gains View

Gains View displays input/output gain level controls, and signal input/output level meters, for all channels within the Current Bank. Channels can also be stereo linked and unlinked in this view.

Refer to the illustration below for all Gains View functions detailed in this section.

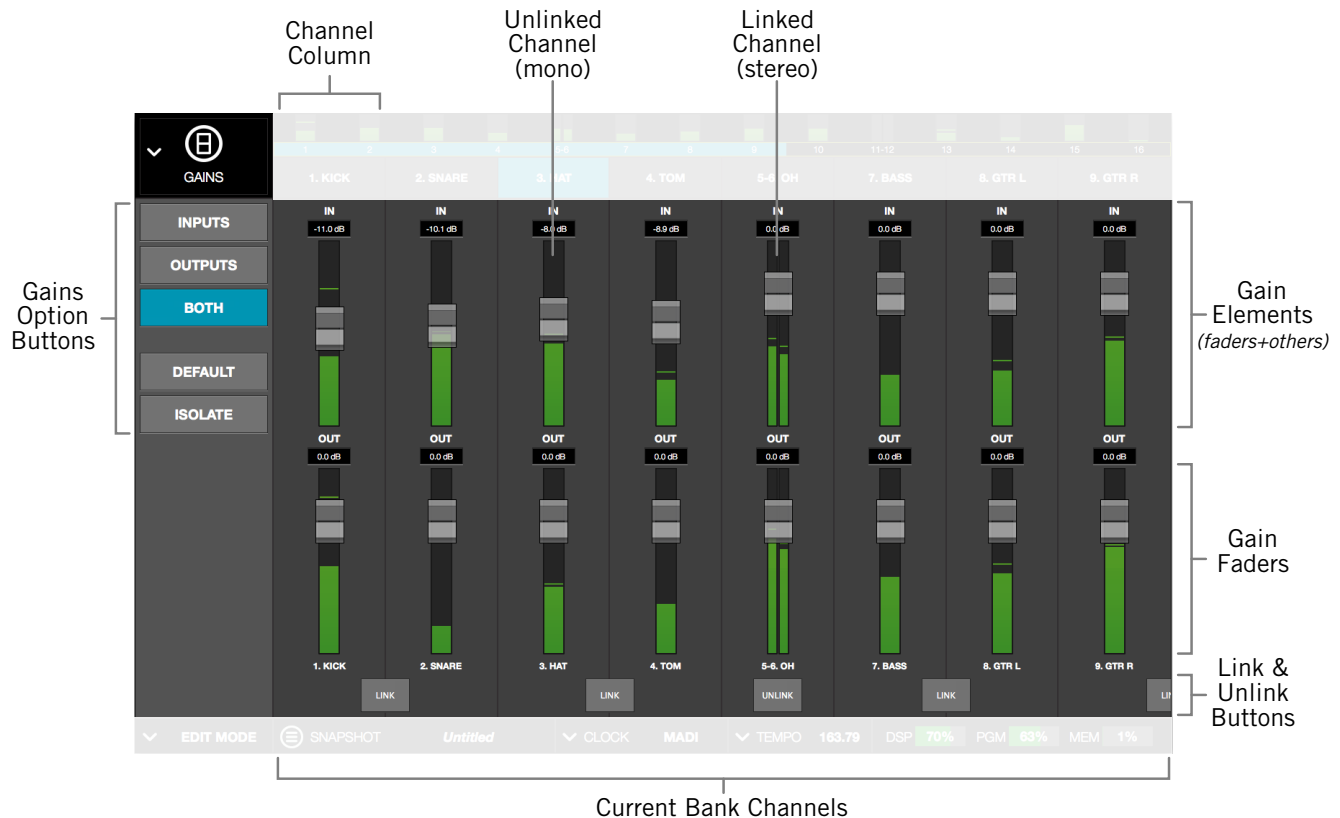

The main elements within Gains view

Bank View

Gains View is one of the three [Bank Views](#). If Gains View is active then a non-Bank View (Channel, Snapshots, or Settings) is activated, single-clicking the input meters in the Meter Bridge will return to Gains View.

Channel Column

The channel column can display input channels, output channels, or both input and output channels, depending on the Gains Option that is specified.

Bank Channels

Like all Bank Views, the number of channel columns displayed in Gains View is defined by the Current Bank, which can be changed by moving the blue Bank Bar in the Channels Bar.

Gain Elements

Each input and output channel has its own set of gain controls and indicators. Refer to the illustration below for descriptions of the elements that follow.

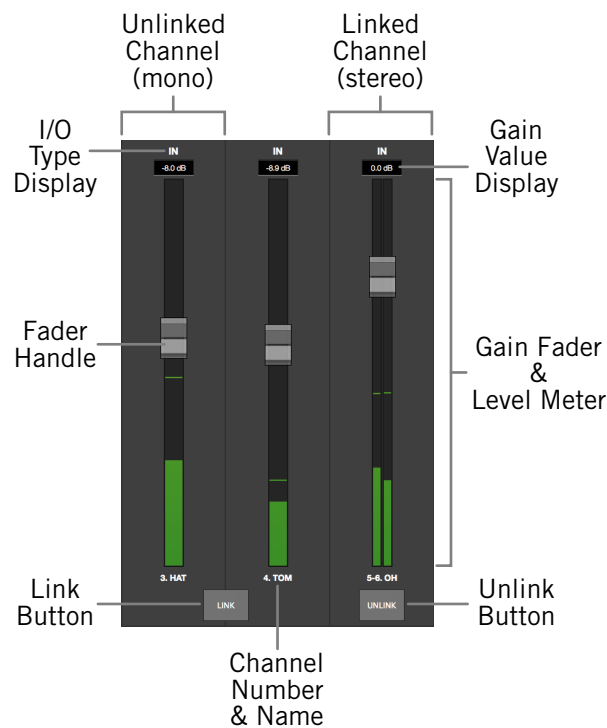

The gain elements

I/O Type

The IN or OUT text is a label that indicates whether the gain controls are for an input channel or an output channel. Each row of gain controls is always of the same. If the BOTH option is active, input gain controls are above the output controls.

Gain Value

This field displays the current gain setting in dB, with one-tenth dB resolution. The value is changed by moving the fader handle.

Gain Fader

The gain faders are used to set the gain of the I/O channels. Drag the fader handle to change the gain value.

The available gain range for all I/O gain faders is from $-\infty$ dB to 12 dB. The default value is 0 dB (unity gain).

Tip: *Option+click any gain fader (or anywhere within a channel column) to set its gain to 0 dB. This operation cannot be undone.*

Input Faders

The input faders adjust the level of the MADI signal before plug-in processing.

Tip: By adjusting the input gain, different sonics can be obtained with UAD plug-in emulations that have (desirable) non-linear input distortion characteristics.

Output Faders

The output faders adjust the level of the MADI signal after plug-in processing. Output adjustments are convenient to compensate for overall level changes that may occur within a plug-in or channel strip.

Fader Handle

Gain values are adjusted with this control. Click+drag the handle down to lower the gain, or up to increase the gain.

Level Meter

The digital signal level of the channel is represented here in green, using standard digital peak metering. The top of the meter range indicates 0 dBFS (digital full scale). The top bar glows RED when 0 dBFS is exceeded (when digital clipping has occurred).

Note: The fader handles are superimposed on the level meters. Therefore, the signal may appear above the handle position.

Input Meters

The input meters are pre-fader. The incoming MADI channel's signal level is displayed.

Output Meters

The output meters display the MADI channel's output level after plug-in processing but before the output fader (post plug-ins, pre-fader).

Channel Number & Name

The channel number and name is displayed here. If no channel name has been entered, only the channel number is displayed (the channel number cannot be modified).

Tip: Channels are named in Channel View by clicking the channel's number/name box within the Main Column, then entering a name in the name field that appears.

Link/Unlink

Two adjacent channels can be combined into a stereo pair. When channels are linked, any control adjustments will affect both channels of the stereo signal identically.

Note: The link and unlink cannot be performed in SAFE mode. The link/unlink buttons are hidden when SAFE mode is active.

Tip: Channels can also be linked/unlinked in Channel View by clicking the channel's number/name box within the main column.

Activating Link

Stereo pairs are created by clicking the LINK button between two adjacent channels.

Caution: When Link is activated, all channel and plug-in settings in the right channel are overwritten by the plug-ins and gains in the left channel. This operation cannot be undone.

When Link is activated:

- The LINK button text changes to UNLINK
- One set of controls is available for the stereo channel
- All current control settings of the left channel are copied to the right channel
- All inserted plug-ins in the left channel are converted to stereo (parameter values are retained)
- The level meter changes to a stereo level meter

Link Deactivation

The stereo pair is separated back into individual channels by clicking the UNLINK button. When LINK is deactivated, all current control settings and inserted plug-ins for the stereo channel are copied to both resulting mono channels.

Link Constraint

Odd-numbered channels can only be linked to the next even-numbered channel (for example, channel 1 can be linked to channel 2, but channel 2 cannot be linked to channel 3).

Gains Options

The Gains Options (in the Main Column, below the View Menu) enable various views to be changed, and operations to be performed, on the channels displayed within Gains View.

View Options

The Inputs, Outputs, and Both options change the I/O channels that are displayed. They do not use latching or modifiers.

Note: One of the view options is always active, including when a latched option is being performed.

Latched Options

The Default and Isolate option operations are accomplished by selecting the option to latch the function, executing the operation(s), then exiting the function.

These latched options use the same methodology as Inserts View. For complete details about latched operations, see [“Option Latch” on page 63](#).

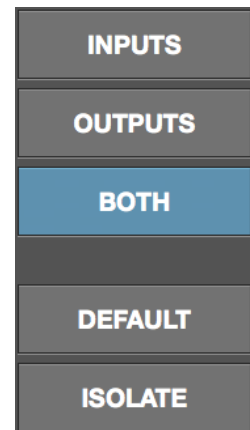

The Gains Options buttons

Inputs

When the Inputs option is active (when the button is blue), only the input gains are displayed. This option enables increased resolution of the gain faders and level meters by increasing the vertical space devoted to the input channels (versus the Both option).

Outputs

When the Outputs option is active (when the button is blue), only the output gains are displayed.

Tip: The Inputs and Outputs view options enable increased resolution of the gain faders and level meters by increasing the vertical size of these elements.

Both

This view option displays all input and output gains in the Current Bank. The vertical size of the gain faders is reduced in this view.

Default

This option facilitates the ability to quickly set one or more displayed gain levels to 0 dB (unity gain). When the Default button is latched, click any gain fader (or anywhere within a channel column) to set its gain to 0 dB.

Note that gain values can be returned to 0 dB without using the Default option. To set a gain value to 0 dB within any screen in Gains View or Channel View, option+click any gain fader.

Important: Gain changes using either of these methods cannot be undone.

Isolate

Isolate prevents a channel's active settings from being modified when a Snapshot (a Real-time Rack configuration file) is loaded.

Isolate is typically used to prevent channel adjustments made during a live performance from being overwritten by Snapshot changes.

When Isolate is latched, click any column modifier to isolate the channel. Click again to de-isolate the channel.

When a channel is isolated, the text “[ISO]” appears beneath the bank channel name in the Channels Bar.

Tip: Channel isolations can also be set in Inserts View.

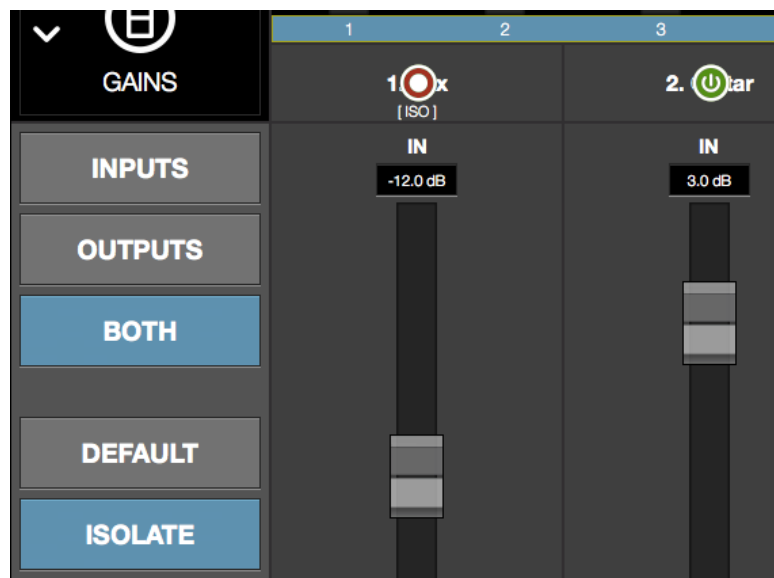

Delay Groups View

Delay Groups are latency compensation tools used to maintain phase alignment across multiple channels when upsampled UAD plug-ins are used in Realtime Rack.

Refer to the illustration below for element descriptions in this section.

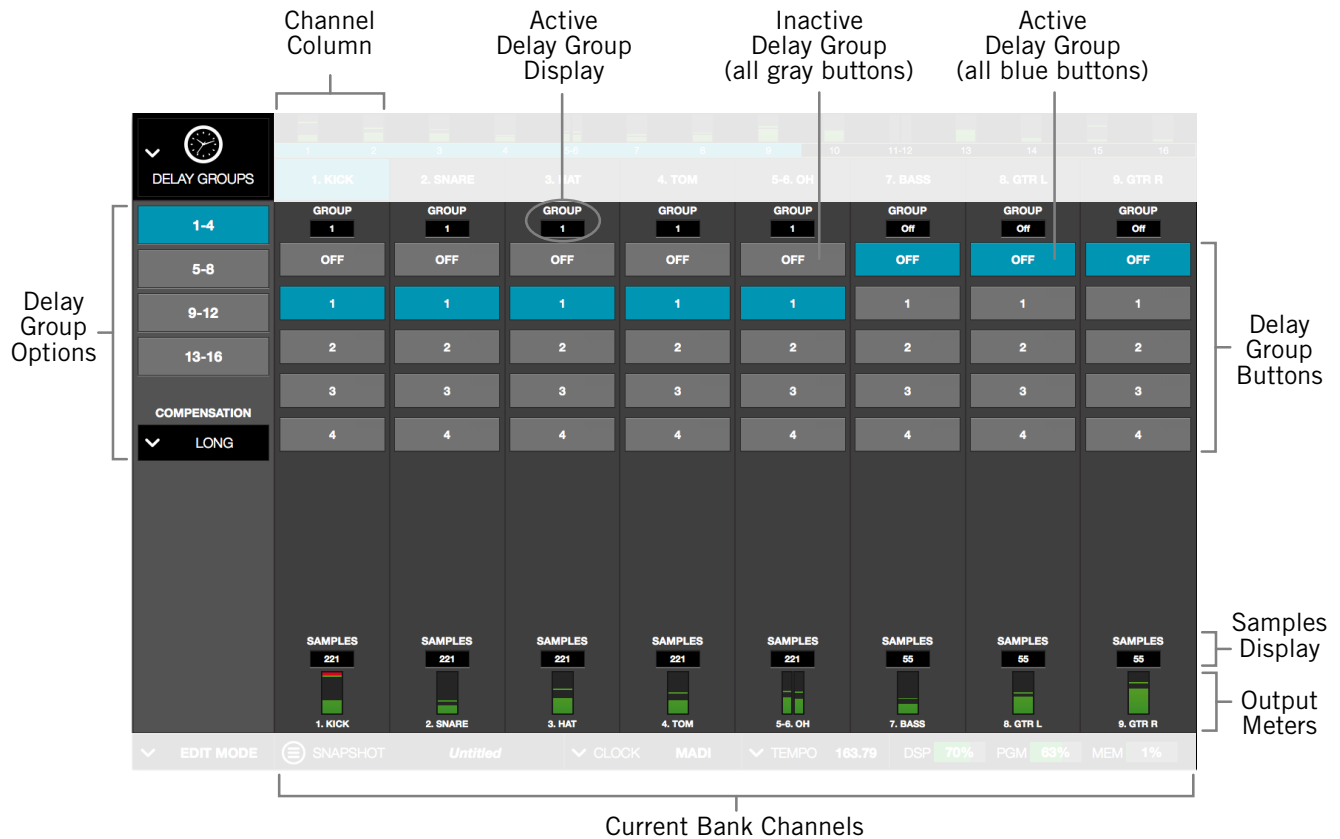

The elements within Delay Groups View

Bank View

Delay Groups View is one of the three [Bank Views](#). If Delay Groups View is active then a non-Bank View (Channel, Snapshots, or Settings) is activated, single-clicking the input meters in the Meter Bridge will return to Delay Groups View.

Channel Column

The elements displayed in the Channel Column is the same for all channels in the Current Bank, and varies depending on the currently selected Delay Group Option.

Bank Channels

Like all Bank Views, the number of channel columns displayed in Delay Groups View is defined by the Current Bank, which can be changed by moving the thin blue Bank Bar within the Channels Bar.

Delay Groups Overview

Upsampled UAD plug-ins

Some UAD plug-ins are *upsampled*, meaning their internal sample rate is increased to achieve sonic design goals. When upsampled UAD plug-ins are loaded in Realtime Rack, additional latency delay is induced in the channel(s) using the plug-in(s).

Although the delay added by each upsampled UAD plug-in is negligible (typically between 0-140 samples, depending on the plug-in and sample rate), this extra delay can affect output phase coherency.

For example, if two microphones are used on an acoustic source (such as a drum kit) and an upsampled plug-in is used on one of the mic channels but not the other, the phase of the two mic channels will no longer be aligned.

Note: For the list of upsampled UAD plug-ins and their specific latency values, see the [“Upsampling Values Table” on page 79](#).

How Delay Groups work

Delay Groups automatically add small amounts of delay to each channel in the group that are *not* delayed by upsampled plug-ins, so all channels in the group are still phase aligned. In other words, all channels in the Delay Group are delayed by the same amount.

Note that the amount of delay added by the Delay Group engine is automatic. Only the minimum amount of delay actually required to compensate the channel(s) is dynamically applied, maintaining the lowest possible latency required for phase alignment at all times.

Up to 16 unique Delay Groups can be configured. For specific instructions, see [“Configuring Delay Groups” on page 77](#).

When To Use Delay Groups

Delay Groups are required to maintain channel phase alignment only when *both* of these conditions are met:

1. Multiple Realtime Rack channels are used for a single source (such as a drum kit using multiple microphones), *and*
2. Any of those source channels contain upsampled UAD plug-ins.

Latency compensation using Delay Groups is *not* needed for any these conditions (when phase coherency is not imperative):

- When upsampled plug-ins are not used on the same source
- When upsampled plug-ins are used on different sources

System Latency

Overall system throughput latency with Realtime Rack is 73 samples when no plug-ins are assigned (and also through non-upsampled plug-ins).

Delay Groups Options

The Delay Groups Options (in the Main Column, below the View Menu) change which Delay Group buttons are displayed and changes the amount of delay compensation that is available.

Delay Group Button Selectors

These buttons determine which Delay Group buttons are displayed in the main screen area. Click these option buttons to display a different set of Delay Group buttons.

The number of buttons that appear here, and their labels (1–8, 9–16, etc), depend on the vertical resolution (pixel count) of the computer's display.

Higher resolution displays can show more Delay Group buttons simultaneously, therefore fewer Delay Group buttons are shown in the Main Column in this case. With lower resolution displays, less space is available for the Delay Group buttons, so more Main Column buttons are available to switch between them.

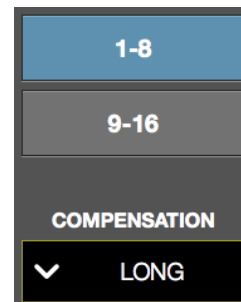

The Delay Groups Options

Compensation Menu

This drop menu determines the maximum compensation delay, in samples, that is available for each channel. Click the menu and select any value to change the setting.

Compensation Values

The available Compensation values are listed in the table below.

Delay Group Compensation Values	
Setting Name	Maximum Available Delay Per Channel (samples)
OFF (Default)	0
SHORT	100
MEDIUM	200
LONG	1000

UAD Resource Usage

Use these guidelines when selecting values from the Compensation Menu:

- **Off** – When set to OFF, the delay compensation engine is disabled and the Delay Group buttons are hidden.
- **DSP** – Delay Groups use a small percentage of DSP resources. To maximize DSP resource availability for UAD plug-ins, only use Delay Groups when necessary.
- **Memory** – Longer Compensation values use more Memory resources. To maximize Memory resource availability for UAD plug-ins, only the smallest value required. Although UAD Memory resources are typically not constrained, it is possible if many time-based plug-ins (reverbs and delays) are active.

Delay Compensation Exceeded

If the maximum available delay compensation amount is exceeded on a channel when inserting an upsampled plug-in, a notification dialog appears. To maintain phase alignment if this occurs, either increase the Compensation Menu value or reduce upsampled plug-ins usage on the channel.

Delay Groups Elements

Refer to the illustration on [page 73](#) for descriptions in this section.

Active Delay Group Display

The Delay Group that the channel currently belongs to is always displayed here. If the channel is not contained within any Delay Group, “Off” is displayed here and the channel is not delay compensated.

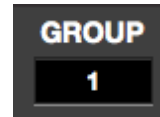

A Delay Group number is displayed here by clicking one of the channel’s numbered Delay Group buttons below the display.

Note: A channel cannot belong to more than one Delay Group.

Delay Group Buttons

There are 16 numbered Delay Group buttons and one OFF button for each channel. Each Delay Group button represents one of the 16 available Delay Groups.

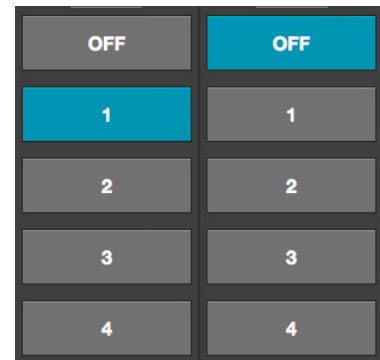

Note: All Delay Group buttons are hidden when the Compensation Menu value is set to OFF.

To add a channel to any Delay Group, click the numbered Delay Group button in the Channel Column. The button is highlighted in blue and the number is reflected in the Active Delay Group display at the top of the channel column.

Note that unless the display monitor has a very high vertical resolution (pixel count), all Delay Group buttons for an individual channel are not displayed concurrently. To view the Delay Group buttons that are not currently visible, use the Delay Group Option buttons in the Main Column.

Samples Display

The Samples display shows the sum of all extra samples (the total latency delay amount) incurred by all upsampled plug-ins inserted in the channel. If a channel is contained within a Delay Group, all channels within the same Delay Group will display the same value, confirming the Delay Group channels are phase aligned.



Note: The Samples Display only shows delay added by upsampled plug-ins. They do not reflect the overall system throughput delay of 73 samples that is inherent on all Realtime Rack channels.

Output Meter

The Output Meter displays the MADl channel's output level after plug-in processing but before the output fader (post plug-ins, pre-fader).

The channel number and name are also displayed here. The channel name's proximity to the Samples display facilitates confirmation that related channels are being delay compensated by the same amount.



Configuring Delay Groups

To setup one or more Delay Groups, follow these instructions:

1. Determine if phase alignment is required for two or more channels. Typically, only channels used for the same source need to be phase aligned. For background information, see [“When To Use Delay Groups” on page 74](#).
2. Make note of which channels require phase alignment (for example, all the channel numbers/names used for the drum kit microphones).
3. Enable the delay compensation engine by setting the Compensation Menu to any value except OFF (off is the default value).
4. Display the Delay Group buttons for the Delay Group to be used by clicking any View Option button in the Main Column. This step is necessary only if the Delay Groups displayed by default are already in use.
5. Add all noted channels to the same Delay Group by clicking the same numbered Delay Group button for each noted channel. The selected buttons are highlighted in blue, and all selected buttons must all be in the same row.

***Tip:** To rapidly add multiple channels to the same Delay Group, click+hold any Delay Group button, then swipe horizontally across multiple channels.*

6. Confirm all the noted channels are in the same Delay Group via the Active Delay Group display at the top of each channel's column. The display must show the same Delay Group value for all the noted channels.
7. Confirm all the noted channels are being compensated equally via the Samples display at the bottom of each channel's column. The display must show the same Samples number for all the noted channels (the Samples value is automatically calculated). If necessary, increase the Compensation Menu value.

Delay Group configuration for the noted channels is complete. Repeat if necessary for another set of channels using a different Delay Group number.

Delay Groups Example

The screenshot below shows an example of a properly configured Delay Group. The TOM and OH channels are assigned to the same Delay Group (Delay Group #1 in this example), and the Samples value is identical for both channels. Note that the Bass channel is not in the Delay Group.

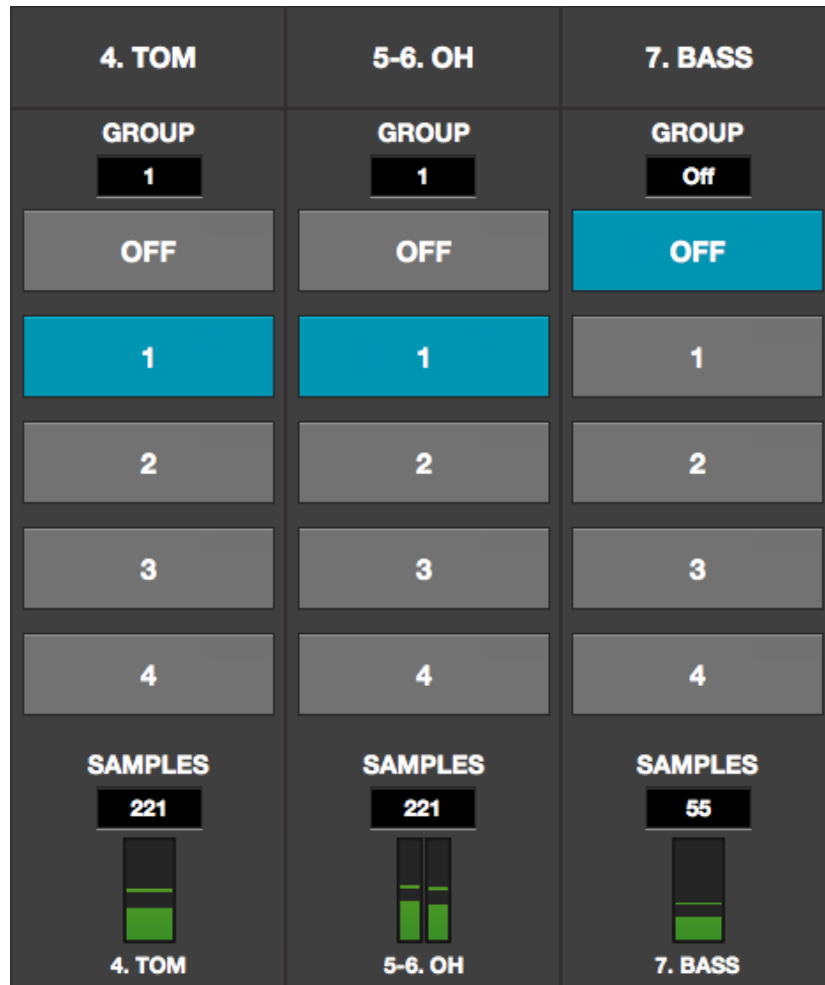

*Typical Delay Group implementation.
Channels in the Delay Group have the same SAMPLES value.*

Upsampling Values Table

The table below lists the additional latency values, in samples, produced by upsampled UAD plug-ins.

UAD Plug-In	Sample Rate (kHz)			
	44.1	48	88.2	96
AKG BX 20 Reverberator	983	974	2078	2060
Bermuda Triangle	88		80	
Ibanez Tube Screamer TS808	88		80	
Raw Distortion	44		40	
API 550A API Vision Channel Strip Fairchild Tube Limiter Collection FATSO Jr./Sr. Manley Massive Passive Manley Variable Mu Moog Filter Neve 1073 (newer model w/preamp) Neve 33609 Neve 88RS (newer model w/preamp) Oxide Tape Recorder Pultec EQP-1A Pultec MEQ-5 Studer A800 Thermionic Culture Vulture UA 1176 Limiter Collection UA 610 Tube Preamp & EQ Collection	55		55	
Fender '55 Tweed Deluxe	119		201	
Precision Limiter	64	69	129	140
Precision Maximizer	67		67	
API 560 Teletronix LA-2A Leveler Collection	56		56	
Helios Type 69 Harrison 32C Neve 1073 Legacy, 1081, 31102 Precision EQ Pultec EQP-1A Legacy Pultec-Pro Legacy Pultec HLF-3C SSL E Channel Strip Trident A-Range	31		13	
Little Labs IBP	32		14	
Lexicon 224* (see note on next page)	84	79	90	97
EMT 250* (see note on next page)	75	11	85	24
MXR Flanger/Doubler	31		0	
Ocean Way Studios	192		688	

****Lexicon 224 & EMT 250 Note***

The EMT 250 and Lexicon 224 anti-aliasing filters for their A/D and D/A conversion are not linear-phase filters; therefore the emulations do not have a latency that is the same at all frequencies. Thus, we cannot report to the delay compensation engines a delay that is correct for all frequencies. The reported values are good at low frequencies, but become off at high frequencies.

For example, when the EMT 250 plug-in is in Delay program mode and set with zero delay time and pre-delay values, the plug-in output will not be completely cancelled when mixing with flipped phase against an unprocessed track; high frequencies will leak through. However, the latency through the dry side of the wet/dry mix, and the latency when the plug-in is bypassed via the EMT 250 Power switch, do not have this issue and will be fully compensated by the Reatime Rack software.



Channel View

Channel View displays the plug-ins, channel strips, I/O gains, and other settings within a single channel. Channel View is used to assign and edit UAD plug-ins and manage plug-ins preset settings.

The channel that is currently being viewed can be navigated with the Channel Bar. The currently selected channel is highlighted in blue in the Channel Bar.



Typical appearance in Channel View. In this screenshot, Single view is active and the plug-in tab is selected so the plug-in interface parameters can be adjusted.

Navigating to Channel View

Channel View can be entered using any of these methods.

- Choose Channel View from the View Menu
- Click any Channel Select button in the Channel Bar
- Double-click any channel in the Meter Bridge
- Click any insert slot in Inserts View
- Click any insert plate in Universe View

Tip: When Channel View is entered using any of the above methods (except via View Menu), the channel is automatically selected and ready for editing.

Selecting Channels within Channel View

In Channel View, the currently selected channel is displayed. To select any channel for viewing, editing, and/or assigning the plug-ins inserted the channel from within Channel View:

1. Bring the channel into the Current Bank by navigating with the thin blue Bank Bar
2. Click any Channel Select button in the Channel Bar to select the channel.

Shortcut: Double-click any Input Meter in the Meter Bridge to enter Channel view and select that channel for editing.

Two View Modes: Single View & Channel Strip View

Channel View has two fundamental modes of operation: *Single* view mode and *Channel Strip* view mode. Single mode facilitates the viewing, editing, and management of individual plug-ins within a channel, while Channel Strip mode facilitates the concurrent viewing, editing, and management of all serially stacked plug-ins within a channel.

View Mode Elements

The screen elements and functions in Channel View depend on the active view mode, and the current selections within the active mode. Some elements and functions are common to both view modes. All elements are detailed later in this section.

Switching View Modes

To enter Channel Strip view, click the **CHANNEL STRIP button** at the bottom of the Main Column. The button is highlighted blue when Channel Strip view is active. Click the button again, or click any Insert Button, to return to Single view.

Common Elements

Some elements that appear, and the functions that can be performed, are common to both Single and Channel Strip view modes. The elements common to both views are the Main Column, Channel I/O Gains, PLUG-IN Tab, and the PRESET Tab.

The common elements are described briefly in the table below.

Element	Description
Channel Name Button	Displays the current channel's NAME field. Click the button to create a custom name for the channel.
Insert Buttons	These represent the channel's eight available insert slots. Shows the name of currently loaded channel plug-ins (if any). Switches between the inserts for editing inserts.
Channel Strip Button	Toggles the channel between Single view and Channel Strip view modes. Facilitates the viewing and editing of multiple plug-in interfaces concurrently.
PLUG-IN(S) Tab	Displays the plug-in interface so sonic parameters can be edited. Depending on the view mode (Single or Channel Strip), different supporting tabs are available.
Supporting Tabs	In Single view, PRESETS and ASSIGN tabs are available for selecting presets and plug-ins. In Channel Strip view, the CHANNEL PRESETS tab is available.
Channel I/O Gains	Input/output gain faders and level meters are available for convenient gain staging. These are the same controls available in Gains View.

Channel View Options

In Channel View, the View Options in the Main Column is identical in both Single and Channel Strip view modes. The options in Channel View are the Channel Name button, the Insert buttons, and the Channel Strip button.

Channel Name Button

The Channel Name button is located directly beneath the View Menu in the Main Column. It displays the name of the channel selected in the Channel Bar. The Channel Name appears alongside the MADI channel number.

When the Channel Name button is clicked, the button is highlighted in blue, and the NAME field and LINK (UNLINK) button appears to the right of the Main Column so the channel can be named or stereo linked/unlinked.

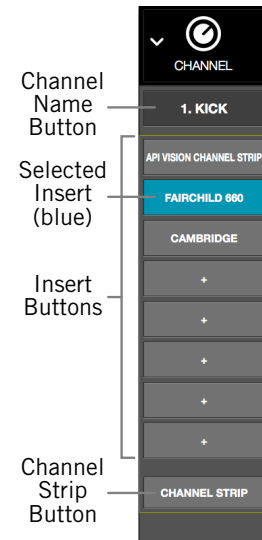

Note: The MADI channel number cannot be modified.

Channel Name Field

To change the channel name, click the Channel Name button to display the NAME field. Type a new value in the NAME field, then type Return (or Enter) or click anywhere outside the field.

At right: Changing the channel name. To see the NAME field and LINK (UNLINK) button, click the Channel Name button.

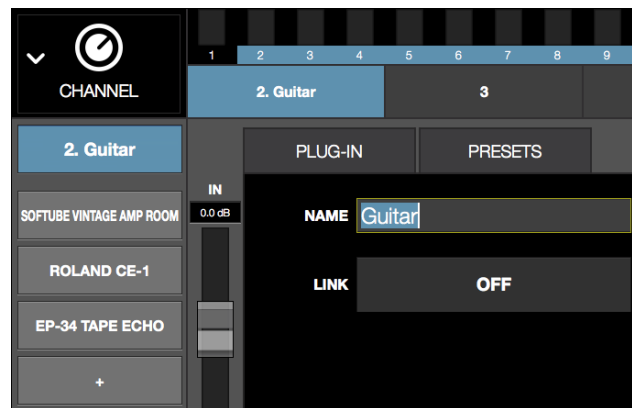

Tip: The NAME field remains visible when other Channel Select buttons in the Channel Bar are clicked so other channels can be quickly renamed.

Channel Link/Unlink

To stereo link or unlink a channel(s) the channel name, click the Channel Name button to display the LINK button (or UNLINK button, if the channels are already stereo linked). Click the Link/Unlink button to change the link state. For specific details about link/unlink behavior, see [“Link/Unlink” on page 70](#).

Important: Link/Unlink can cause significant audio changes and can only be performed in EDIT mode.

Insert Buttons

The Insert Buttons are located in the Main Column. Each Insert Button represents one of the eight insert slots for available for UAD plug-in processing within a single channel.

Populated inserts contain the plug-in name and empty inserts contain the plus “+” symbol.

Note: In SAFE mode, all plus “+” symbols are hidden and plug-ins cannot be assigned to the channel.

Insert Button Behavior

Insert buttons can be controlled with the mouse or the keyboard, as described below.

Click

Clicking an Insert button with the mouse selects the insert. The insert is selected when its button is highlighted in blue.

If the insert already contains a plug-in when its button is clicked, its interface is displayed in the PLUG-IN tab so the plug-in parameters can be modified.

If the insert does not already contain a plug-in (any button with the plus “+” symbol), the ASSIGN tab is displayed so a plug-in can be loaded into the insert.

If Channel Strip view is active (if the CHANNEL STRIP button is highlighted blue), the channel is switched to Single view and the buttons behave as described above.

Focus

In Single view, if an Insert button has focus (when the button is selected and its button is highlighted in blue) and the Return or Enter key is typed, the PRESETS tab is selected so plug-in settings files can be navigated and loaded from disk.

In Channel Strip view, if the channel strip has focus (when the CHANNEL STRIP button is highlighted in blue and the FOCUS outline is around the Insert and Channel Strip buttons) and the Return or Enter key is typed, the PRESETS tab is selected so channel strip settings files can be navigated and loaded from disk.



Channel Signal Flow

Audio signals in a channel flow through the inserts serially from top to bottom. Therefore, if more than one plug-in is inserted in a channel, the location of a plug-in within the inserts can impact the sound of the channel.

Insert Reordering

Inserts can be reordered to change the location of a plug-in within the channel signal flow. For example, it's possible to move an EQ to be located before or after a compressor to change the processed sound.



To reorder the inserts, click, hold, and drag any Insert Button up or down with the mouse. Existing assignments are automatically reordered as needed to accommodate the change. Inserts can be reordered in Single view and Channel Strip view.

Note: This operation can only be performed in EDIT mode.

Insert State Indications

The color of each button, as well as *italic plug-in names*, indicate of the current state of each insert. The possible states are shown at right and described below.

Selected (light blue) – The plug-in is active and processing audio, and the insert is selected for editing. The PULTEC EQP-1A insert button at right indicates this state.

Active (light gray) – The plug-in is active and processing audio. The TELETRONIX LA-2A GRAY insert button at right indicates this state.

Inactive (dark blue) – The plug-in has been disabled by the power button in Channel View, and the plug-in name is *italicized*, and the plug-in displays a [Status Bar](#) in the PLUG-IN Tab. The EMT 250 insert button at right indicates this state.

Note: Disabling a plug-in via the power control within the plug-in interface (versus the power button in Channel View) does not change the background color nor italicize the name.

Disabled (red) – The plug-in is disabled because there is not enough UAD resources, it is unlicensed and the demo has expired, and/or the UAD authorization needs updating. The plug-in name is also *italicized* and the plug-in displays a [Status Bar](#) in the PLUG-IN Tab. The MANLEY MASSIVE PASSIVE insert button in the screenshot indicates this state.

Italic Name – The plug-in is not processing audio because it is either inactive or disabled.

Empty (+) – The insert is not populated with a plug-in. Click the plus "+" symbol to assign a plug-in into the slot.



Note: The plus “+” symbol on all Insert buttons is hidden in SAFE mode.

Channel Strip Button

The Channel Strip button is used to enter Channel Strip view. Channel Strip view combines all plug-ins in a channel into a single view for convenient editing and settings management.



Activating Channel Strip View

To enter Channel Strip view, click the CHANNEL STRIP button at the bottom of the Main Column. To exit Channel Strip view and enter Single view, click the CHANNEL STRIP button again to change it to gray, or click any Insert button.

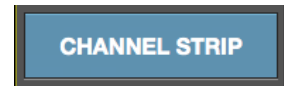

Remove Plug-In Shortcut

Plug-ins can also be removed from inserts in using the shortcut on the Inserts buttons. This operation cannot be performed in SAFE mode.



Tip: Plug-in removal operations in Inserts View can be much quicker, especially when removing numerous plug-ins.

To use the shortcut:

1. Click+hold on any Insert button containing a plug-in
2. Drag to the left to reveal the Remove modifier icon
3. Click the Remove icon to delete the plug-in from the insert.

To cancel the operation, click anywhere else in the Insert Buttons area (anywhere *except* the Remove icon).

Channel I/O Gains

Input and output gain faders and signal level meters are displayed within all screens in Channel View, between the Inserts Buttons and the Tab displays. The Channel I/O Gains are used to adjust view and adjust input and output levels for individual channels.

The channel I/O fader and meter functionality is exactly the same as in Gains View, where the I/O gain controls are displayed concurrently for all channels. For details about these controls, see [“Gain Elements” on page 69](#).

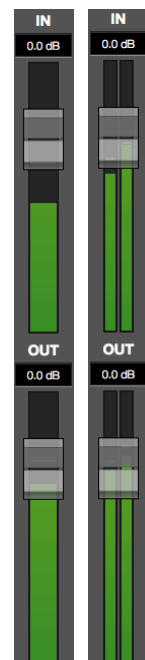

PLUG-IN Tab

The PLUG-IN Tab is where the UAD plug-in interface is displayed and plug-in parameters are edited. In Single view, the PLUG-IN Tab displays the plug-in interface of the currently selected Insert Button in the Main Column. In Channel Strip view, the interfaces of all plug-in in the channel are displayed concurrently.



General Use

For general information about how to use the UAD plug-in interface (such as how to adjust controls) see [“Chapter 6: Using UAD Powered Plug-Ins”](#) beginning on page 133.

Specific Controls

For information about the specific features and controls available within each individual UAD plug-in, see the [UAD Plug-Ins Manual](#).

Channel Strip View

If Channel Strip view is active, the interfaces all inserted plug-ins in the channel are displayed in the PLUG-INS tab concurrently. In Channel Strip view, the Tab name is PLUG-INS (plural) to reflect that multiple plug-in interfaces are displayed in Channel Strip view concurrently.

Channel Strip Button

The Channel Strip button is used to enter Channel Strip view. Channel Strip view combines all plug-ins in a channel into a single view for convenient editing and settings management.



CHANNEL STRIP

Activating Channel Strip View

To enter Channel Strip view, click the CHANNEL STRIP button at the bottom of the Main Column. To exit Channel Strip view and enter Single view, click the CHANNEL STRIP button again to change it to gray, or click any Insert button.



CHANNEL STRIP

Navigation Scroll

If the interfaces of all plug-ins in the channel cannot be contained within the available vertical screen space, vertical and/or horizontal scroll bars appear in the PLUG-INS tab to enable the viewing of all interfaces in the channel strip.

Hidden Functions

In Channel Strip view, the ZOOM slider and plug-in DEACTIVATE button are hidden and cannot be modified.

Channel Strip Variances

Channel Strip view is active when the CHANNEL STRIP button is highlighted in blue. Additionally, the following functions are changed to accommodate Channel Strip view:

- All Insert Buttons are grouped and highlighted in blue
- The plug-in ZOOM slider is hidden
- The plug-in DISABLE button is hidden
- PRESETS and ASSIGN tabs are hidden
- The title of the PLUG-IN tab changes to PLUG-INS
- If the interfaces of all plug-ins in the channel cannot be contained within the available vertical screen space, vertical scroll bars appear in the PLUG-INS tab to enable the viewing of all interfaces in the channel strip.

Status Bar

The Status Bar is a horizontal strip below the plug-in interface that appears when there is an exception to the usual operational state of the plug-in. The status bars are described below.



The Status Bar appears beneath the plug-in interface to indicate operating exceptions

- **No Status Bar** – The plug-in is authorized, active, and processing audio.
- **DEMO (days remaining)** – The plug-in is active and processing audio, but it is operating in demonstration mode. The number of days remaining in the demo period is displayed in the Status Bar. Demos can be started for each individual plug-ins in View Menu>Settings>PLUG-INS. For related information, see [“Demo Mode” on page 144](#).
- **POWERED OFF** – The plug-in has been disabled by the Power Button in Channel View or Inserts View.

***Note:** Disabling a plug-in via the power control within the plug-in interface (versus the Power button in Channel View) does not display this Status Bar.*

- **DISABLED** – The plug-in is disabled because there is not enough UAD resources, it is unlicensed and the demo has expired, and/or the UAD authorization needs updating.

Power Button

The Power button deactivates the selected plug-in and reduces UAD resource loads. When a plug-in is deactivated with this button, the button is red and POWERED OFF appears in the [Status Bar](#) under the plug-in interface.



The Power button is located between the Tabs and the ZOOM slider in Channel View when the PLUG-IN Tab is active. To disable the currently selected plug-in, click the green Power button. To re-enable the plug-in click, the Power button again.



Zoom Slider

The ZOOM slider increases the size of the currently selected plug-in interface. Zooming enlarges all controls in the interface for enhanced visual feedback and controls manipulation.

The Zoom setting is unique for each individual UAD plug-in. The zoom setting for each plug-in is global; the setting is used throughout Channel View wherever the interface appears.

Note: *Zoom is unavailable in Channel Strip view.*

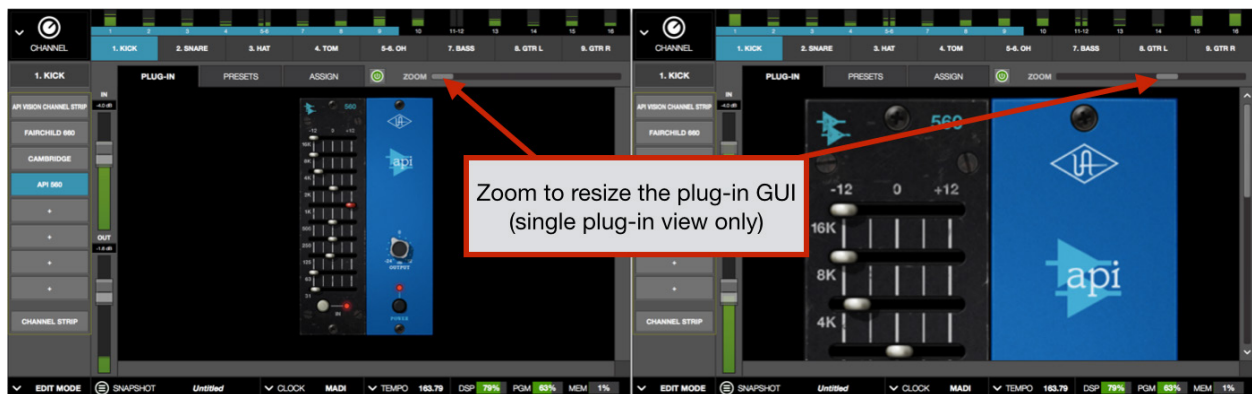

The Zoom slider

PRESETS Tab

The PRESETS tab is where UAD plug-in settings are managed after a plug-in is assigned to an Insert. Preset management tasks are performed on the currently selected Insert.



The PRESETS tab displays 3 columns with the currently selected plug-in's presets, sub-folders (if applicable), and the FILE menu for creating user-defined presets and folders.

Presets Defined

A preset is a complete collection of settings for an individual plug-in that is saved as a disk file so the settings can be subsequently recalled. Presets are typically used to save and recall favorite plug-in settings. Thousands of factory presets are installed with the software, or they can be user-created.



Note: Preset files do not contain a channel's I/O gain values. However, I/O gain values are stored within Snapshots (complete Realtime Rack configuration files).

Preset files have the “.vst” suffix (file suffixes are only visible in the OS X Finder when the “Show all filename extensions” option is checked in the OS X Finder's Preferences window).

Factory Presets

Factory presets are plug-in settings created by the plug-in developers for typical use case scenarios. All UAD plug-ins developed by Universal Audio include a batch of factory presets. They can be used as-is, or modified as desired.



All factory presets are read-only; they cannot be overwritten, renamed, deleted, or moved. However, factory presets can be saved under a different name or in a different file location. Factory presets are indicated by a lock icon at the left of a preset icon.

Note: *Not all Direct Developer (3rd-party) plug-ins include factory presets.*

Presets Folder Location

All factory and user preset files are stored at the following location within the Mac OS X file system:

- Macintosh HD/Library/Application Support/Universal Audio/Presets

Plug-In's Preset Folder

Inside the presets folder are folders named with the title of each UAD plug-in. Each of these folders contain all factory and user presets for that particular plug-in. This is the *plug-in's preset folder*. The contents of this folder is displayed in the PRESETS column when the PRESETS tab is selected.



Note: *User presets can only be saved to the plug-in's preset folder. Therefore, the plug-in's preset folder is the starting point, and highest level, for file system navigation within the PRESETS tab.*

Preset Sub-Folders

Each plug-in's preset folder can contain a maximum of one nested sub-folder for additional preset organization capability. This additional folder is the *preset sub-folder*. The contents of this sub-folder (if any) is displayed in the SUB-FOLDER column when a folder in the PRESETS tab is selected.

Channel Strip Defined

A Channel Strip is a complete collection of plug-ins within a single channel, and all parameter settings within those plug-ins, that is saved as a disk file so the channel strip can be subsequently recalled into the same or a different channel. All Channel Strips are user-created.



Note: *Channel Strip files do not contain a channel's I/O gain values. However, I/O gain values are stored within Snapshots (complete Realtime Rack configuration files).*

Channel strip files have the “.uadchannel” suffix. File suffixes are only visible in the OS X Finder when the “Show all filename extensions” option is checked in the OS X Finder's Preferences window.

Channel Strip Folder Location

All Channel Strip files are stored at the following location within the Mac OS X file system:

- Macintosh HD/Library/Application Support/Universal Audio/Presets/Channel Strip

Channel Strip Sub-Folders

The Channel Strip folder may contain a maximum of one nested sub-folder for additional channel strip organization capability. This additional folder is the *Channel Strip sub-folder*. The contents of this sub-folder (if any) is displayed in the SUB-FOLDER column when a folder in the CHANNEL PRESETS tab is selected in Channel Strip view.



Note: Channel Strip presets can only be saved to the Channel Strip folder. Therefore, the Channel Strip folder is the starting point, and highest level, for file system navigation within the CHANNEL PRESETS tab.

PRESETS Tab Columns

The PRESETS tab contains three columns: FILE, PRESETS, and SUB-FOLDERS. These columns are used to manage and navigate the preset files.

Note: In Channel Strip view mode, the PRESETS tab is named CHANNEL PRESETS.

FILE Column

The FILE column in the PLUG-IN tab contains buttons used to name, save, and perform other file management tasks. Click the button to perform the operation on the currently selected preset or sub-folder.

SAVE

Saves the current modified preset file in place. The preset file must already exist or the button is unavailable (gray). Use the SAVE AS button to perform the initial save operation.

SAVE AS

Creates a new preset file to disk with the plug-in's current settings. Opens the SAVE PRESET AS file dialog overlay so a new preset name can be entered and saved to a location within the plug-in's preset folder. A sub-folder can be created within the SAVE PRESET AS dialog.

RENAME

Presents the RENAME PRESET dialog overlay so the currently selected preset can be renamed.

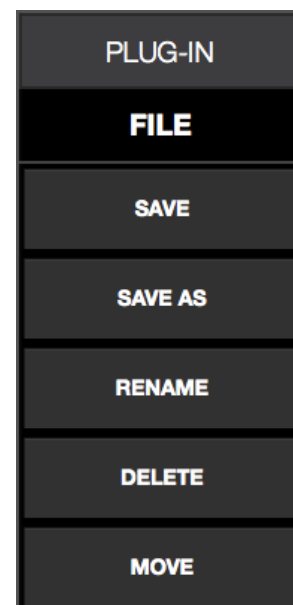

DELETE

Presents the DELETE PRESET dialog overlay so the currently selected item can be permanently deleted. This operation cannot be undone.

MOVE

Presents the MOVE dialog overlay so the currently selected item can be moved to another location within the plug-in's preset folder.

PRESETS Column

When the PRESETS tab is selected, the PRESETS column is visible and all items within the plug-in's preset folder are displayed. Actions in the FILE menu can be performed on items selected in the PRESETS column.

Click any preset in the PRESETS column to instantly load it, or click a sub-folder (if any) to display presets within the sub-folder in the SUB-FOLDER column.

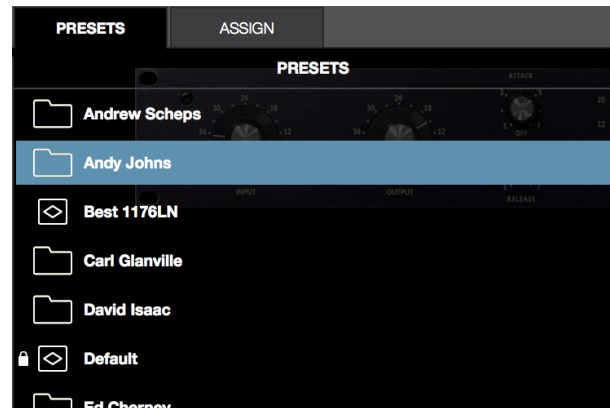

SUB-FOLDER Column

If the PRESETS column contains one or more folders, selecting the folder will display items in the sub-folder. Actions in the FILE menu can be performed on any item selected in the SUB-FOLDER column.

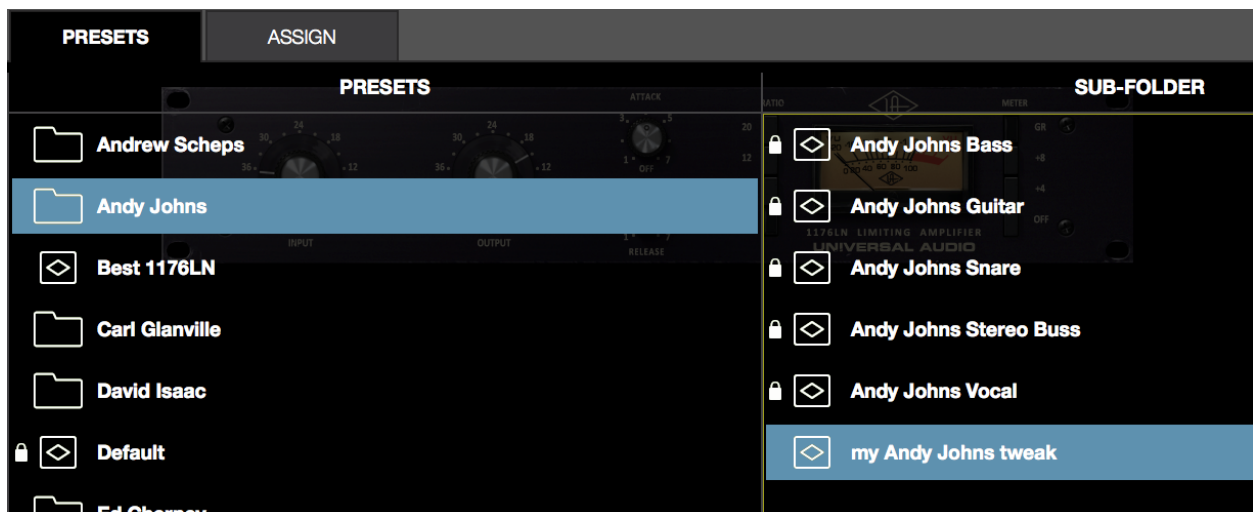

The SUB-FOLDER column is displayed when a folder in the PRESETS column is selected

ASSIGN Tab

The ASSIGN tab is used to assign (load) plug-ins into empty inserts and reassign (replace) existing plug-ins that are already assigned in a channel insert. Actions in the ASSIGN tab are performed on the currently selected insert.

Note: The ASSIGN tab is unavailable in Channel Strip view.

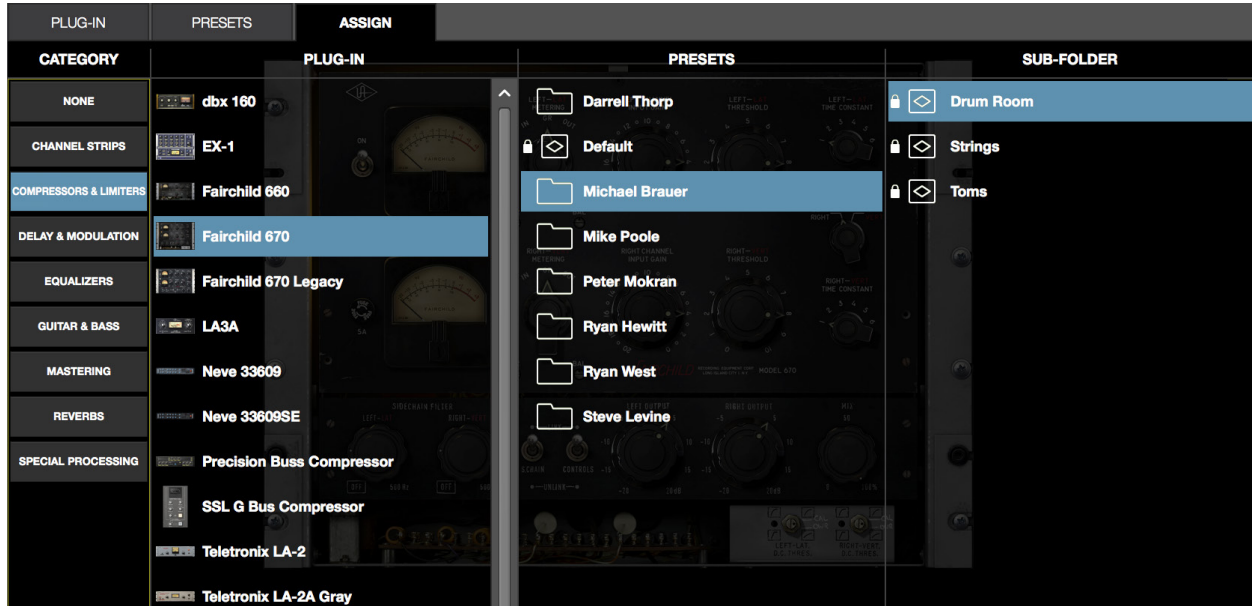

The ASSIGN tab showing typical selections within the Category menu

CATEGORY Buttons

UAD plug-ins that have similar processing functionality are grouped within categories. The CATEGORY buttons in the ASSIGN tab represent these plug-in categories.

Note: Some plug-ins are in multiple categories (when applicable).

Plug-ins are assigned and reassigned by selecting a category button, then choosing a plug-in or preset from the PLUG-IN, PRESETS, or SUB-FOLDER columns that appear when a category is selected.

Making selections

Click a Category button to “drill down” through available selections. Single-click a plug-in to display the PRESETS column (and SUB-FOLDER column, if any) columns. Double-click a plug-in to load it with its default settings. For detailed instructions, see [“How To Assign Inserts” on page 96](#).

PRESETS & SUB-FOLDER Columns

These columns function identically to the same columns in the PRESETS tab. For details, see [“PRESETS Tab Columns” on page 93](#).

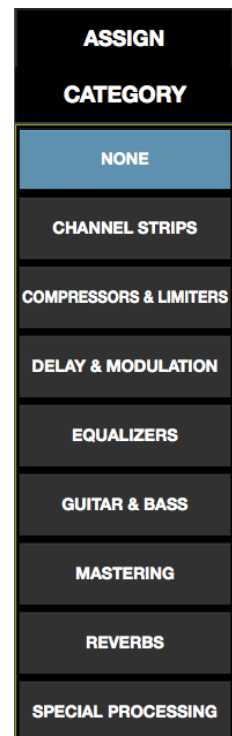

Plug-In Categories

Available plug-in categories are listed in the table below.

Note: Some plug-ins are in multiple categories (when applicable).

CATEGORY	CONTENTS
NONE	Indicates that no plug-in is assigned. If a plug-in is already assigned, the button can be used to unload the plug-in.
CHANNEL STRIPS	Single plug-ins featuring multiple modules, such as EQ and dynamics
COMPRESSORS & LIMITERS	Dynamics plug-ins
DELAY & MODULATION	Delay, echo, chorus, modulation, phaser, and doubler plug-ins
EQUALIZERS	EQ plug-ins
GUITAR & BASS	Guitar and bass amplifiers and tuners
MASTERING	Mastering plug-ins
REVERBS	Digital reverb, analog reverb, and room emulation plug-ins
SPECIAL PROCESSING	Tape machine, enhancement, transient designer, and phase tools

How To Assign Inserts

Follow these instructions to assign (load), reassign (change), and de-assign (remove) plug-ins from any insert in Channel View.

Note: These operations can only be performed in EDIT mode.

Assign Insert

1. Single-click any empty insert button in any View screen to switch into Channel view and select the insert. The ASSIGN tab and the CATEGORY buttons are displayed, with NONE as the currently selected category.
2. Single-click any CATEGORY button to select it. The plug-ins within the category are displayed in the PLUG-IN column. Use the vertical scroll bar to view all the plug-ins if necessary.
3. Single-click any plug-in in the PLUG-IN column to assign it to the insert. The plug-in is loaded with its default preset, it begins processing audio on the channel, and the PRESETS column (and SUB-FOLDER column, if any) are displayed.
4. If desired, single-click any preset in the PRESETS or SUB-FOLDER columns to load a different preset. Use the vertical scroll bar to view all the presets and/or sub-folders if necessary.

Done. Exit assign mode by pressing enter or clicking a different element. Click the PLUG-IN tab to view the plug-in's interface and edit its parameters.

Reassign Insert

1. Single-click any populated insert button in any View screen to switch into Channel view and select the insert. The PLUG-IN tab is selected and the plug-in interface is displayed.
2. Single-click the ASSIGN tab. The CATEGORY button of the current plug-in is selected, along with the PRESET column (and SUB-FOLDER column, if any).
3. Single-click any CATEGORY button to select it. The plug-ins within the category are displayed in the PLUG-IN column. Use the vertical scroll bar to view all the plug-ins if necessary.
4. Single-click any plug-in in the PLUG-IN column to assign it to the insert. The old plug-in is replaced by the new plug-in with its default preset, and the PRESETS column (and SUB-FOLDER column, if any) are displayed.
5. If desired, single-click any preset in the PRESETS column (or SUB-FOLDER column, if any) to load the preset. Use the vertical scroll bar to view all the presets and/or sub-folders if necessary.

Done. Exit assign mode by pressing enter or clicking a different element. Click the PLUG-IN tab to view the plug-in's interface and edit parameters.

De-assign Insert

Tip: Plug-in de-assignment in Inserts View via the Remove function can be much quicker, especially when removing numerous plug-ins.

1. Single-click any populated insert button in any View screen to switch into Channel view and select the insert. The PLUG-IN tab is selected and the plug-in interface is displayed.
2. Single-click the ASSIGN tab. The CATEGORY button of the current plug-in is selected, along with the PRESET column (and SUB-FOLDER column, if any).
3. Single-click the NONE category button. The plug-in is removed from the insert and UAD resources used by the plug-in are released.

Done. Exit assign mode by pressing enter or clicking a different element.

Tip: Plug-ins can also be de-assigned using the shortcut on the insert buttons (shown at right). For details, see [page 86](#).



Snapshots View

A Snapshot is complete Realtime Rack configuration file used for total session recall. Snapshots contain all parameter values within the Realtime Rack application.

Snapshots View is a dedicated file management screen for saving, modifying, recalling, importing, and exporting Snapshot files. Snapshots View has the four sections described in the table below.

SNAPSHOTS SECTION	DESCRIPTION
Snapshot Options	The options the Main Column contain the various Snapshot file and folder management functions.
Folders & Snapshots Columns	Displays a list of user-defined folders and Snapshots in two columns.
Recall Panel	Displays the currently loaded Snapshot, the currently primed (selected) snapshot, and the Recall button to load the primed Snapshot.
Universe View	Displays a high-level view of the currently loaded Snapshot. Colored boxes indicate the presence and status of all plug-ins in all channels.

Snapshot Defined

A snapshot is a complete collection of all settings for the entire active Realtime Rack configuration. “All settings” are all parameter values in all Views, including all plug-in assignments in all channels, the current settings and state (active, disabled, etc) of all assigned plug-ins, and I/O Gain and Delay Group settings for all channels. All Snapshots are user-created.



Snapshots are saved as a disk file so the complete session can be subsequently recalled and/or transferred between systems and operators. Snapshots can be loaded directly from within the Soundcraft Vi console via Ethernet using the Vi CUE functions.

Snapshots files have the “.uadmix” suffix. File suffixes are only visible in the OS X Finder when the “Show all filename extensions” option is checked in the OS X Finder’s Preferences window.

Snapshots Folder Location

All Snapshot files are stored at the following location within the Mac OS X file system:



- Macintosh HD/Users/[account name]/Documents/Universal Audio/Snapshots

Snapshot Versus System Contents

The table details the information that is stored in a Snapshot file and the differences between a Snapshot and what is stored within the system.

Settings Stored In Snapshots (changed when Snapshot is recalled)	Settings Stored In System (persist when Snapshot is recalled)
Snapshot name	Clock Source setting
Snapshot MIDI Program Change number	Sample Rate setting
Snapshot BPM (Tempo)	MADI process order setting
Session channel-count (16, 32, 48, or 64)	Device order setting
Plug-ins and settings per-channel (includes all parameters and DSP power state)	Channel Name
Input and Output Gain settings per-channel	All screen preferences (as set in the Hardware tab within Settings View)
Stereo Link state per-channel	All MIDI preferences (as set in the MIDI tab within Settings View)
Delay Group setting per-channel	All Plug-Ins preferences (as set in the PLUG-INS tab within Settings View)

Snapshot Key Commands

At any time (not just in Snapshots view), two key commands can be executed for saving the current Snapshot in place (SAVE), or saving the current s\Snapshot as a new Snapshot (SAVE AS).

Key Command Name	Key Command	Description
Save Snapshot	COMMAND+S	Saves the current snapshot in place
Save Snapshot As...	COMMAND+SHIFT+S	Saves the current snapshot as a new snapshot with a new name and/or location

Recalling Snapshots

Recalling a Snapshot can cause destructive actions such as building and/or reordering of plug-in chains. Therefore, when a Snapshot is recalled, channels may be muted to avoid audio artifacts.

If a Snapshot is loaded that has the same plug-in configuration as the currently loaded Snapshot, the plug-ins are not rebuilt and only parameter values are changed, enabling a (mostly) artifact-free Snapshot recall workflow.

Caution: *When SAFE mode is active, Snapshots can still be recalled, which can potentially overwrite current plug-in assignments and cause audio artifacts during live a performance.*

Base Snapshot Workflow

Recalling Snapshots can be potentially destructive in that entire plug-ins and plug-in channel strips can be torn down and re-built, potentially causing audio artifacts and/or silence for the duration of the Snapshot loading process.

For this reason, it is highly recommended that a “Base Snapshot” be prepared that contains all of the plug-ins required to get through a show/performance and only create snapshots that are saved as variants of the base snapshot.

Important: *Recalling Snapshots created using the method below will result in parameter values being changed without significant glitches or muting.*

To create Snapshots variants from a base Snapshot:

1. Create the base Snapshot by loading as many plug-ins as needed for the show/performance/session.
2. [Navigate to Snapshots View](#).
3. Click **SAVE AS** to save and name the base Snapshot file.
4. When a change is needed (for example, for a change in the song or a different song that needs new settings), click **SAVE AS** again to create and name the variant Snapshot.
5. Make the parameter changes needed in the variant Snapshot and press **SAVE**. This locks the parameter change deltas into the variant Snapshot file.
6. Repeat steps 4 and 5 for all the variant snapshots that are needed.

The base and variant Snapshots can now be switched with minimal artifacts.

File Columns

The upper middle section of the Snapshots View screen shows two columns that display the Snapshot folders and the Snapshot files contained within the folders. Similar to how plug-in and channel strip presets are managed, these folders and files are used to load and manipulate the files in various ways.

Unlike plug-in and channel strip presets however, there are some differences between how Snapshots are loaded and moved. These differences were designed for safety reasons (for example, to prevent accidental triggers during a live show).

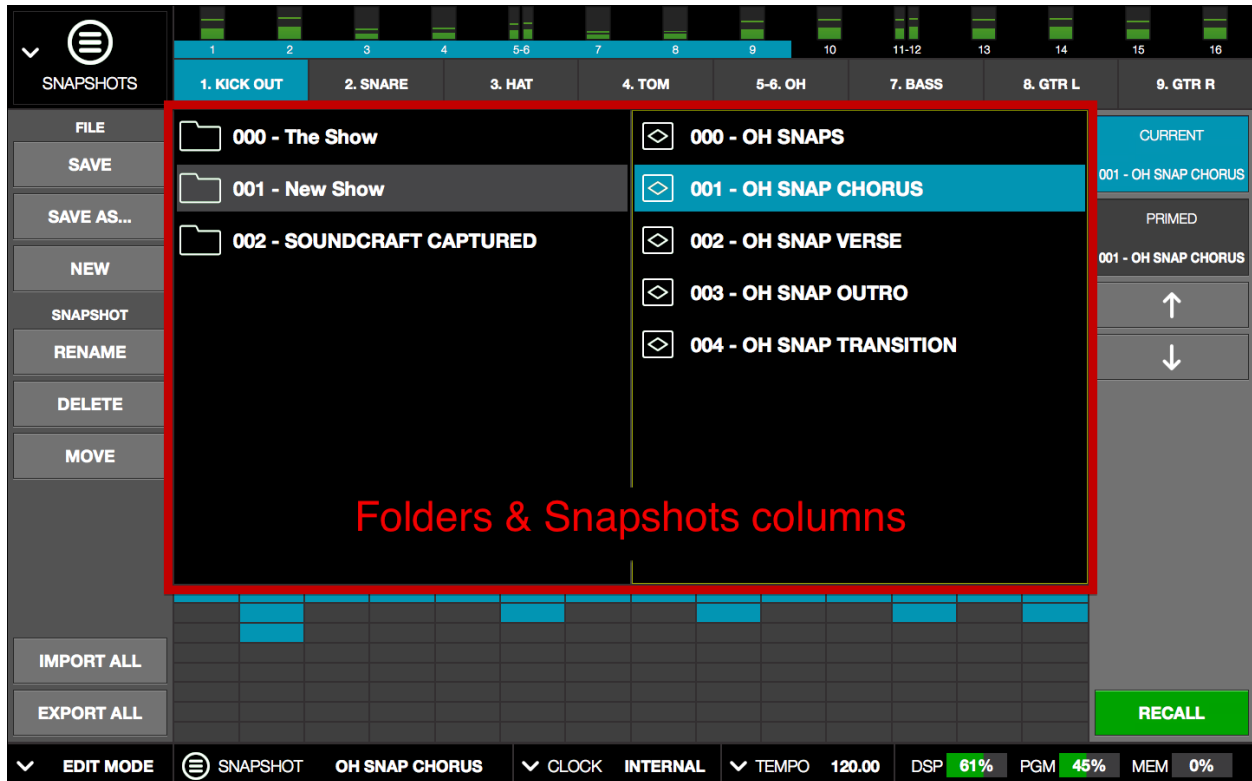

The Snapshots View columns display the Snapshot folders (left) and Snapshot files (right)

Snapshots Term Definitions

The following terms are used in this section:

Folders Column – The left column in Snapshots View containing the snapshot folders

Snapshots Column – The right column in Snapshots View containing the snapshot files

Slot – A three-digit prefix number automatically used by every Snapshot and Snapshot folder. The slots determine the order that folders and Snapshots are displayed, and they are used for MIDI Bank/Program change commands.

Snapshot – A file containing complete session settings for all channels including plug-ins, gains, and Delay Group values.

Folder – A folder containing one or more Snapshot files.

Prime – Select, but do not load, a Snapshot in the list.

Recall – Loading of a primed Snapshot and recalling all session settings.

Soundcraft Cue – Soundcraft's name for a Snapshot. Cues can contain settings for all aspects of their digital consoles.

Navigating to Snapshots View

All Snapshots operations are performed in Snapshots View. To enter Snapshots View, use either of these methods:

- Choose Snapshots View from the View Menu
- Click anywhere in the Snapshot area in the Info Bar

When Snapshots View is entered, the Snapshots column has keyboard focus.



Keyboard Focus & Navigation

In Snapshots View, QWERTY keyboard focus is targeted on the Snapshots column (the column on the right). The mouse or keyboard UP/DOWN keys can be used to prime a different snapshot. Using the LEFT arrow key, focus can be changed to the Folders column and the UP/DOWN arrow keys can be used to navigate through folders (if they exist).

Folders Column

The Folders column displays a list of user-defined folders that contain the user-defined Snapshots. If no folders exist (for example, if no Snapshots have ever been saved), new folders can be created with the SAVE AS option button. To learn more about creating new snapshots and folders, see [“Snapshots Options” on page 105](#).

There are two color-coded states that a folder display:

Snapshot State	Color	Description	Example
Idle Folder	Black	The folder is present in the system but not selected.	
Selected Folder	Gray	The folder is selected and displaying its contents in the Snapshots column.	



To Select a Folder:

1. [Navigate to Snapshots View](#).
2. Navigate to the folder column using any of these methods:
 - Single-click anywhere in the folders column to give it focus
 - Press the LEFT arrow key to swap keyboard focus from the Snapshots column
 - Press the TAB key three times to cycle focus through the Snapshots column, Meter Bridge, Channel Bar buttons, and the Folders column
3. When the desired folder is selected, the contents of the folder is displayed in the Snapshots column.

Snapshots Column

The Snapshots column displays a list of user-defined Snapshot files. If no Snapshots exist (for example, if no Snapshots have ever been saved), new Snapshots can be created with the NEW or SAVE AS option buttons. To learn more about creating new snapshots and folders, see [“Snapshots Options” on page 105](#).

There are three color-coded states that a Snapshot folder can display:

Snapshot State	Color	Description	Example
Idle Snapshot	Black	The Snapshot is present in the file system but not loaded or primed.	
Primed Snapshot	Gray	The Snapshot is primed (selected) and next in the cue to be recalled if the RECALL button is engaged.	
Current Snapshot	Blue	The selected Snapshot is the currently loaded Snapshot.	

Modified Snapshot

If any settings have changed since the Snapshot was last saved, the name of the Snapshot appears in italics.



To Prime and Recall a Snapshot:

1. [Navigate to Snapshots View](#).
2. Prime a Snapshot. This can be done using any of these methods:
 - Click any Snapshot with the mouse
 - Click the UP/DOWN buttons in the Recall Panel
 - Press the UP/DOWN arrow keys to navigate through available Snapshots

Note: When a Snapshot is PRIMED, it appears in the Recall Panel.

3. Load the Snapshot. This can be done using either of these methods:
 - Click the green RECALL button with the mouse
 - Press the RETURN or ENTER key on the keyboard

The Snapshot is recalled and the session is re-configured.

If the previously-active Snapshot had been modified since it was last saved, the MODIFIED SNAPSHOT dialog overlay appears, providing options to SAVE, DON'T SAVE, or CANCEL the load.

Important: If the Modified Snapshot dialog overlay appears, the primed Snapshot is not recalled unless/until the SAVE or DON'T SAVE button is clicked.

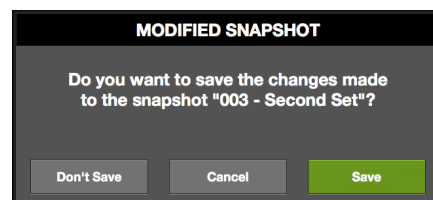

MIDI Bank & Program Change Recall

Snapshots can be loaded using MIDI Bank/Program change commands. The three-digit slot prefixes in the Snapshot and Snapshot folder names correspond to received MIDI bank and program numbers that will select the folders and recall the Snapshots.

Snapshot folder slot numbers – These slot numbers correspond to the MIDI bank number needed to select the folder.

Snapshot slot numbers – These slot numbers correspond to the MIDI program number needed to recall the Snapshot.

Snapshots Options

The Snapshots Options (in the Main Column, below the View Menu) enable various operations (save, new, move, etc) to be performed on Snapshots and Snapshot Folders displayed within Snapshots View.

Save Button

Saves the currently loaded (not primed) Snapshot in place. A Snapshot has been modified when its name is displayed in *italics*.



To save the current Snapshot with the same name and location:

1. [Navigate to Snapshots View](#).
2. Confirm you want to overwrite the currently loaded Snapshot. The current Snapshot is indicated in the following ways:
 - The CURRENT display in the Recall Panel
 - The SNAPSHOT name in the Info Bar
 - A blue Snapshot name in the Snapshots column (its parent folder must be selected to see this)
3. Press the SAVE button. The Snapshot file is replaced with current settings.

Save As Button

Saves the currently loaded Snapshot as a new Snapshot file with a new name and the new Snapshot becomes the currently loaded Snapshot.



To save the Snapshot as a different file:

1. [Navigate to Snapshots View](#).
2. Click the SAVE AS button. The SAVE SNAPSHOT AS dialog overlay appears. The name field is highlighted, and the currently selected folder is used as the default destination in the FOLDER drop menu.
3. Type a new name for the Snapshot. Slot number prefixes are added automatically and don't appear in the dialog.
4. Choose the destination for the Snapshot file. By default, the file will be saved to the folder shown in the FOLDER drop menu. Choose a different existing folder from the drop menu, or click the NEW FOLDER button to create a new destination folder.
5. Click SAVE (or press Return). The Snapshot file is created in the destination folder and it is now the currently loaded Snapshot.

New Button

Creates a new empty Snapshot within the currently selected folder. The new Snapshot appears in the column but is not primed or selected.



To create a new empty Snapshot:

1. [Navigate to Snapshots View](#).
2. Click the NEW button. A new empty Snapshot named "Untitled" appears in the Snapshot column within the current folder, but it is not primed or selected.

FOLDER/SNAPSHOT Options

When the folder column is focused, the heading displays FOLDER and the options are performed on the Snapshot folder. When the Snapshot column is focused, the heading displays SNAPSHOT and the options are performed on the Snapshot.

Rename Button

Renames the currently selected folder or Snapshot.



To rename a folder or Snapshot:

1. [Navigate to Snapshots View](#).
2. Click the RENAME button. The RENAME dialog overlay appears and the name field is highlighted.
3. Type a new name for the folder or Snapshot.
4. Click OK (or press Return). The folder or Snapshot is renamed.

Delete Button

Deletes the currently selected folder or Snapshot.

A dark gray rectangular button with the word "DELETE" in white, uppercase letters.

Important: When a folder is deleted, all Snapshots contained within the folder are also deleted.

Caution: Delete operations permanently remove user data and cannot be undone.

To delete a folder or Snapshot:

1. [Navigate to Snapshots View.](#)
2. Click the DELETE button. The DELETE confirmation dialog overlay appears to prevent inadvertently losing data.
3. Click OK (or press Return). The folder or Snapshot is deleted.

Move Button

On folders, Move enables changes the MIDI Bank Change slot order. On Snapshots, Move changes the MIDI Program Change slot order and/or enables moving the selected Snapshot to another folder.

A dark gray rectangular button with the word "MOVE" in white, uppercase letters.

To move a folder to a different MIDI Bank Change slot:

1. [Navigate to Snapshots View.](#)
2. Click the MOVE button. The MOVE dialog overlay appears and the name field is highlighted with the current slot number displayed.
3. Type a new slot number between 0 – 999. Do not enter a folder name here (use the Rename button for to rename folders).
4. Click MOVE (or press Return). The folder is renamed with the new slot number. If the slot number already exists, see Move Shuffle below.

To move a Snapshot to a different folder and/or MIDI Program Change slot:

1. [Navigate to Snapshots View.](#)
2. Click the MOVE button. The MOVE SNAPSHOT AS dialog overlay appears. The name field is highlighted, and the currently selected folder is used as the default destination in the FOLDER drop menu.
3. Type a new slot number between 0 – 999. Do not enter a Snapshot name here (use the Rename button for to rename folders).
4. Choose the destination for the Snapshot file. By default, the file will be saved to the folder shown in the TO drop menu. Choose a different existing folder from the drop menu, or click the NEW FOLDER button to create a new destination folder.
5. Click MOVE (or press Return). The Snapshot file is moved to the destination folder and it is primed for loading in the Recall Panel. If the slot number already exists, see Move Shuffle below.

Move Shuffle

If a folder or Snapshot already exists at the destination slot, the FOLDER/SNAPSHOT EXISTS dialog overlay appears, presenting the following choices:

- **Shuffle** – Automatically shuffles (moves) populated slots, making room for the moved item so all slot data is retained
- **Overwrite** – Moves the item to the existing slot and deletes the existing item in the destination slot.

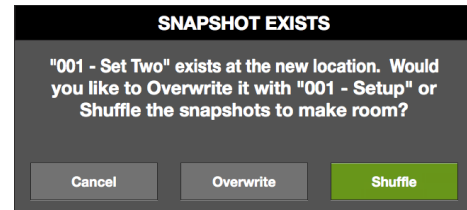

IMPORT/EXPORT

Import and export are provisions to simplify transporting all Snapshot files and folders on the host computer between different Realtime Rack systems and/or operators.

For example, after completion of a concert or other project, the entire Snapshot folder/file hierarchy can be exported to a USB thumb drive connected to the host computer so they can be carried home without the system.

Import/export data file locations are fixed (import does not search the entire source volume for exported data). The file locations are listed below.

Export All

All Snapshot data can be exported to any volume currently mounted on the host computer. The original Snapshots folder hierarchy is retained on export.



The location of the exported data depends on the volume specified during export:

Exported Data Location – Startup Volume Specified

- Macintosh HD/Users/[account name]/Documents/Universal Audio/Exported Snapshots/[user-defined folder name]

Exported Data Location – Alternate Volume Specified

- [Volume Name]/Universal Audio/Exported Snapshots/[user-defined folder name]

To export all Snapshots:

1. [Navigate to Snapshots View.](#)
2. Click the EXPORT ALL button in the Main Column. The EXPORT ALL SNAPSHOTS dialog overlay appears. The EXPORT AS name field is highlighted, and the startup volume appears as the default destination in the VOLUME drop menu.
3. Choose a destination volume from the VOLUME drop menu. Only currently mounted volumes appear in the menu.
4. Click the EXPORT ALL button within the dialog overlay. All Snapshot data is exported to the specified volume.

Import All

Snapshot data can be imported from any volume currently mounted on the host computer, if the data exists in an exported data location (the data to be imported must exist at the same location it was exported to).

IMPORT ALL

The original Snapshots folder hierarchy is retained on import if the same items don't already exist in the destination system. If the same destinations exist, options are provided to Append, Replace, or Cancel the import operation.

Imported Data Location

Imported data uses the same location used by Snapshots that aren't imported:

- Macintosh HD/Users/[account name]/Documents/Universal Audio/Exported Snapshots/[user-defined folder name]

To import all Snapshots:

1. [Navigate to Snapshots View.](#)
2. Click the IMPORT ALL button in the Main Column. The IMPORT ALL SNAPSHOTS dialog overlay appears.
3. Choose a source volume from the VOLUME drop menu. Only currently mounted volumes appear in the menu. If the volume contains exported data, the exported folder name is displayed.
4. Select the folder to be imported by clicking it so it is highlighted.
5. Click the IMPORT ALL button within the dialog overlay. All Snapshot data is imported to the specified volume.

If Snapshot data already exists, the IMPORT SNAPSHOTS dialog appears, with the following options:

- **Append** – Adds the imported data to the existing data
- **Replace** – Overwrites (deletes) the existing data
- **Cancel** – Cancels the import operation

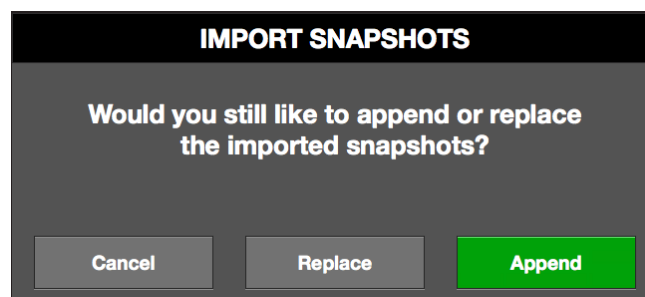

Recall Panel

The Recall Panel displays the Active Snapshot and the Snapshot that is primed and ready to be loaded. It also contains the Recall button to load the primed Snapshot, and navigation buttons for priming Snapshots.

Active Snapshot Display

The Active (currently loaded) Snapshot is displayed in the blue CURRENT panel along with its MIDI Program Change slot number prefix. The panel is blue to correspond with currently loaded Snapshot as displayed in the Snapshot column.

Tip: The currently loaded Snapshot is also displayed in the Info Bar in all Views.

Primed Snapshot Display

The Primed (selected, but not loaded) Snapshot is displayed in the black PRIMED panel along with its MIDI Program Change slot number prefix.

This display is continuously updated as available Snapshots are navigated. The Primed Snapshot is loaded when the RECALL button is pressed.

Recall Snapshot Button

The green RECALL button is used to load the Primed Snapshot shown in the black PRIMED display.

Up/Down Buttons

These buttons can be used to navigate and prime Snapshots in the Snapshots column. Snapshots in the column are highlighted in gray when as they are navigated and primed.

When using these buttons and the last (or first) Snapshot in the column is reached, navigation continues through the contents in the next (or previous) Snapshot folder.

Tip: The equivalent up/down functions can be performed with the QWERTY Up/Down arrow keys when the Snapshots column has focus.

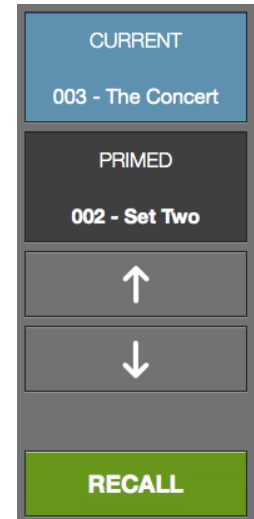

The Recall Panel





Universe View

The Universe view displays a high-level overview of assigned plug-ins in the currently loaded snapshot while in Snapshot View. Universe view provides a simple way of knowing that a plug-in has been loaded and if the plug-in is active, powered off, and/or disabled.

Tip: For a more detailed view of plug-in states, use Inserts View.

Plug-In State Buttons

In Universe view, assigned plug-ins are represented by colored state buttons. The state buttons are color coded and mirror the colored state indications in Inserts View and Channels View. The table below describes the button colors.

Plug-In State	Description	Example
Active or Demo	The plug-in is loaded and processing audio. This is also the state when a plug-in's demo is active and not expired.	
Powered Off	The plug-in has been powered off via the Power button in Channel View or Inserts View.	
Disabled	The plug-in has been disabled due unavailable UAD resources, authorization errors, or the demo period is expired.	
Empty	No plug-in is assigned in the insert.	

Navigating with Universe View

Clicking any plug-in state button will switch to Channel View and select the plug-in for editing. This is particularly convenient when a Snapshot is recalled; if there is an unexpected state with a recalled Snapshot's plug-in, the plug-in can be instantly navigated for any needed corrections.

Tip: Click any plug-in state button in Universe view to switch to Channel View and select the insert for editing.

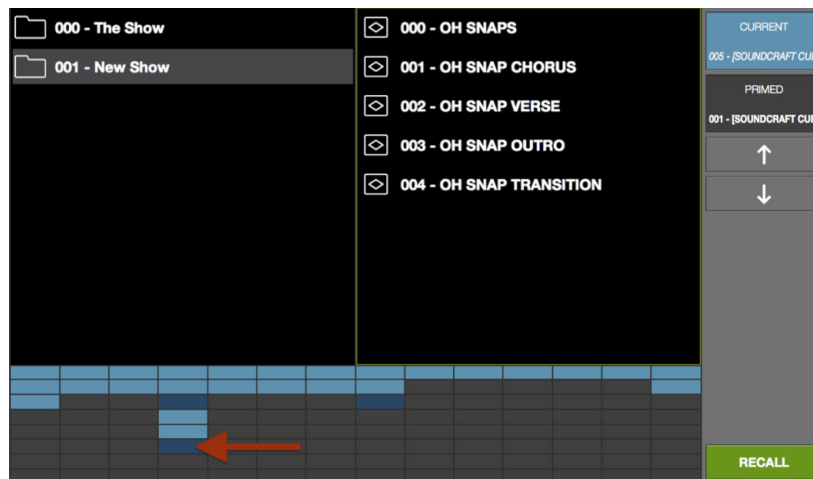

The dark blue state button indicates this plug-in is powered off. Click the button to jump to Channel View so the plug-in can be modified if desired.

Settings View

Settings view allows the user to define various preferences, settings, and behaviors that affect the hardware and operation of Realtime Rack.

Most of the settings made in the Settings view are global to the system and don't get stored with a Realtime Rack snapshot file. All exceptions are noted.

Unlike all other Views, Settings View doesn't have View Options buttons in the Main Column. Instead, settings are arranged in tab views, with each tab displaying a set of related settings.

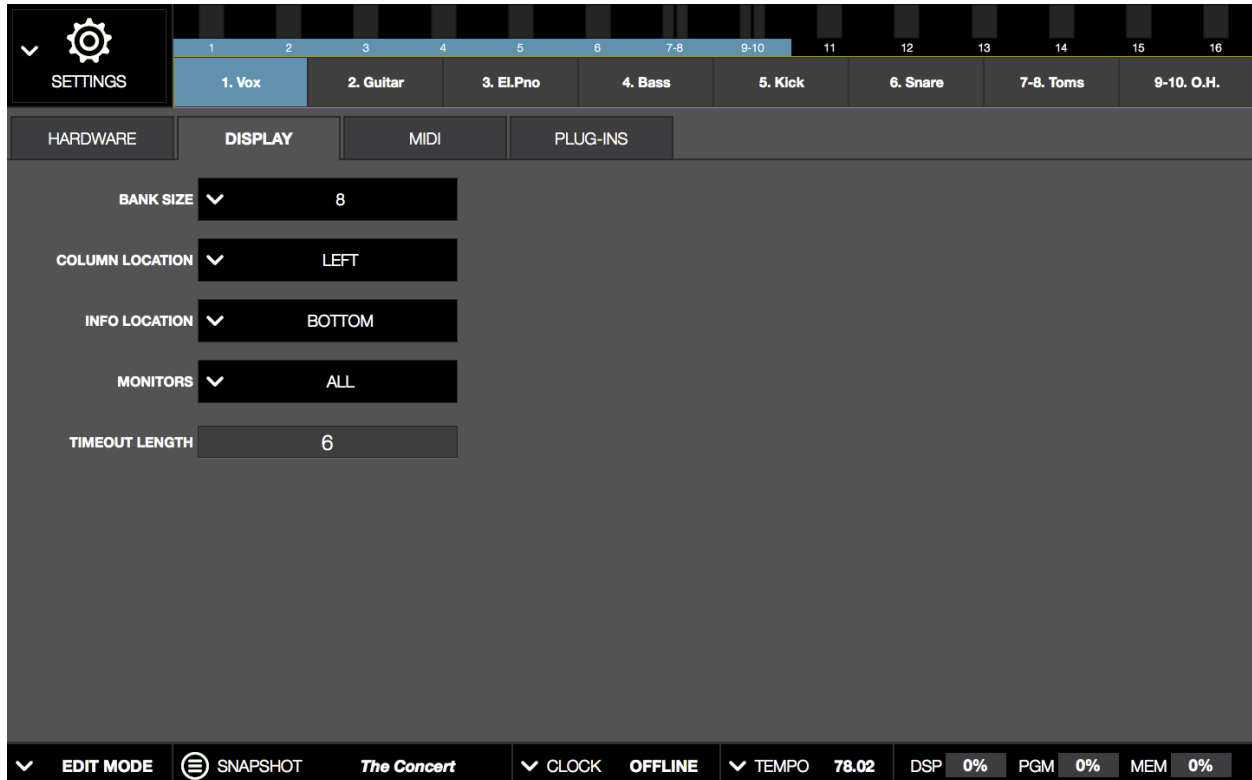

Typical screen in Settings View. In this screenshot, the DISPLAY tab settings are shown.

Navigating to Settings View

To enter Settings View, choose it from the [View Menu](#) in the Main Column.

Settings Tab Names

To see the settings in any tab in Settings View, click the tab name.



The tab names in Settings View

Hardware Tab

Each setting in the Hardware tab is described below.

Sample Rate Menu

Sets the sample rate of the Realtime Rack system. To change the sample rate, click the SAMPLE RATE drop menu and choose a new value from the menu.

Realtime Rack supports the following sample rates (in kHz): 44.1, 48, 88.2, and 96. Set the sample rate to 48 kHz when used with Soundcraft Vi Consoles.

Clock Source Menu

Sets the digital clock source for the Realtime Rack system. To change the clock source, click the CLOCK SOURCE drop menu and choose a new value from the menu. The Clock Source cannot be modified in SAFE mode.

The clock source can also be selected in the Info Bar. The Info Bar also includes status indications in the [Clock Display](#).

Realtime Rack can synchronize to external MADI clock, external word clock, or Internal clock. In typical use, Realtime Rack should be set to MADI clock (the default value) for synchronization with the digital audio from/to the Soundcraft Vi console.

MADI

When MADI is the clock source and multiple Realtime Rack units are properly connected, no additional clock distribution is needed (e.g., word clock).

Word Clock

When the clock source is word clock, the first Realtime Rack unit (MADI channels 1 – 16) must receive the word clock. Then route the word clock to the second Realtime Rack unit, and so on, to up to four Realtime Rack units.

MADI Channels Menu

Specifies the range of contiguous MADI channels to be processed by Realtime Rack. To change the MADI Channels, click the MADI CHANNELS drop menu and choose a new value from the menu.

The MADI channels to be processed depend on the number of installed Realtime Rack units. For example, if one Realtime Rack is installed for 16 channels of processing, the available menu selections are 1–16, 17–32, 33–48, or 49–64.

If two units are installed for 32 channels of processing, the available menu selections are 1–32, 17–48, or 33–64, and so on, for up to four units with 64 channels of processing, in which case only 1–64 is available in the menu.

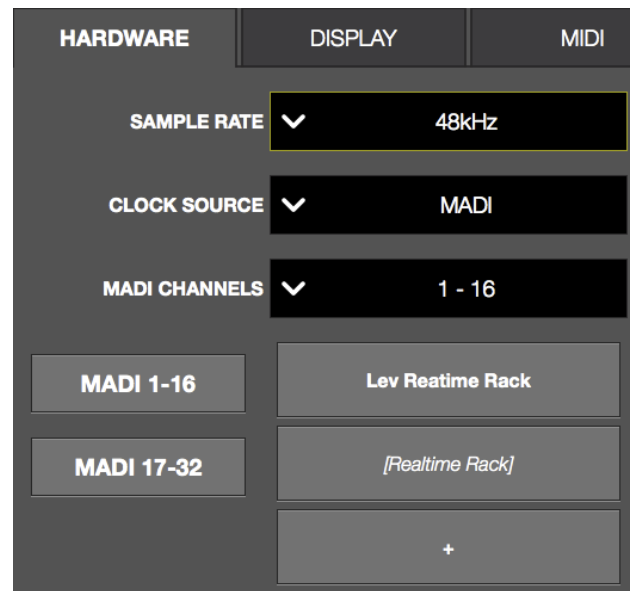

Device Buttons

Buttons displayed in this area depend on the number of Realtime Rack units that are connected. The screenshot shows a two unit system.

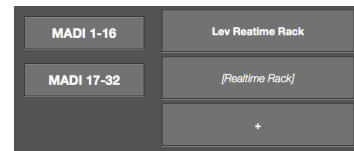

Identify Unit Buttons

The Identify Unit buttons (shown as “MADI 1-16” and MADI 17-32” in the screenshot at right) display which MADI channels are being processed by the Realtime rack unit(s).



When the hardware is properly connected, clicking the Identify button(s) will flash the front panel LEDs on the unit processing those MADI channels. This function is convenient when cabling and/or troubleshooting.

Unit Buttons

These buttons perform several functions. They can be used to rename the unit and add/remove units for offline configurations. In a multi-unit configuration, they can re-order the MADI channels processed by each unit without physically rerouting the MADI cables.



Note: *Italics in a Unit Button indicates the unit is offline.*

- To rename the unit, double-click the button to enter a different unit name. The default unit name is [Realtime Rack].
- To add a unit for offline configuration, click the “+” button.
- To delete an offline unit, click+hold a button and swipe (drag) to the right then click the red remove icon.
- To re-order the MADI channels processed by each unit, drag and drop these buttons up and down as needed. Note this operation will cause a system reconfiguration and there may be a delay before the operation is completed.

Display Tab

Each setting in the Display tab is described below.

Bank Size Menu

Sets the number of channels displayed in the Channels Bar and the blue Bank Bar. To change the bank size, click the BANK SIZE drop menu and choose a new value from the menu.

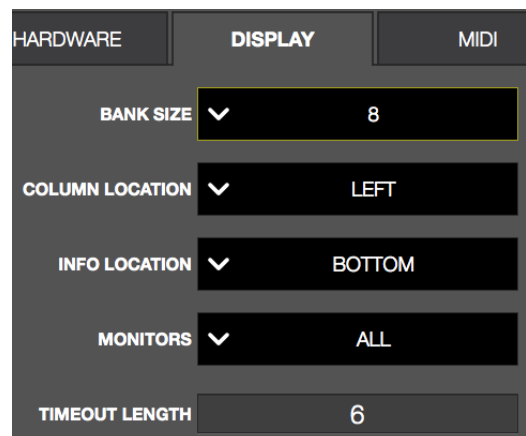

Column Location Menu

Sets the location of the Main Column in all screens containing the column.

To change the Main Column location, click the COLUMN LOCATION drop menu and choose a new value from the menu.

Info Location Menu

Sets the location of the Info Bar in all screens.

To change the Info Bar location, click the INFO LOCATION drop menu and choose a new value from the menu.

Monitors Menu

With multiple-display systems, determines whether the Realtime Rack application is shown in ALL displays or only the MAIN display. To change the setting, click the MONITORS drop menu and choose a new value from the menu.

With multiple display systems, the MAIN display is the display containing the OS X Menu Bar (as defined in /Utilities/System Preferences.app>Displays>Arrangement tab).

Multiple Display Operation

With multiple-display systems, when the Monitors menu is set to ALL, the screen on each display can have different View screen so more elements can be displayed concurrently.

Note: An individual plug-in interface cannot be displayed on two displays concurrently.

Timeout Length Menu

Sets the period, in seconds, used for [Option Latch](#) operations. To change the setting, click the TIMEOUT LENGTH field and enter a numerical value.

MIDI Tab

Realtime Rack supports the ability to remotely recall Snapshots via MIDI Bank/Program change commands, and set the tempo used for the Tempo Sync feature.

MIDI data is received by Realtime Rack via the Mac OS X operating system. To verify and/or configure MIDI devices, use the Audio MIDI Setup application included with the OS at:

- /Utilities/Audio MIDI Setup.app>MIDI Window

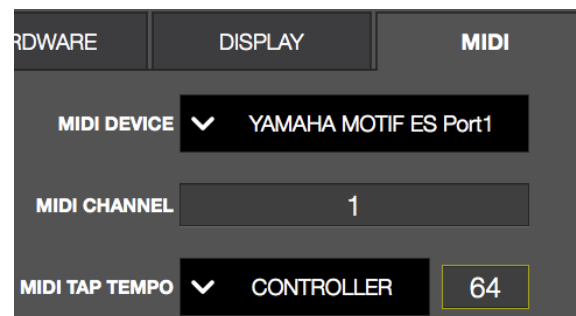

MIDI Device Menu

Sets the MIDI device to be used as the source for MIDI control. To set the device, click the MIDI DEVICE drop menu and choose a new device from the menu.

***Note:** Only devices configured in Audio MIDI Setup.app are available for selection in this menu.*

MIDI Channel Field

Specifies the MIDI channel to be used for MIDI control. To set the channel, click the MIDI CHANNEL field and enter a numerical value between 1 – 16.

MIDI Tap Tempo

Realtime Rack can receive note or controller data for MIDI control of Tap Tempo. These two settings define the MIDI data type and value used for MIDI control. For instructions, see [“Changing tempo values via MIDI” on page 58](#).

MIDI Type Menu

Sets the MIDI data type to be used as the source for MIDI control. To set the data type, click the drop menu and choose CONTROLLER or NOTE from the menu.

MIDI Value Field

Sets the MIDI data value to be used as the source for MIDI control. To set the data value, click the field and enter a numerical value between 0 – 127.

When NOTE is used as the MIDI type, the table below can be used as a reference for MIDI note values.

Note	Octave										
	-1	0	1	2	3	4	5	6	7	8	9
C	0	12	24	36	48	60	72	84	96	108	120
C#	1	13	25	37	49	61	73	85	97	109	121
D	2	14	26	38	50	62	74	86	98	110	122
D#	3	15	27	39	51	63	75	87	99	111	123
E	4	16	28	40	52	64	76	88	100	112	124
F	5	17	29	41	53	65	77	89	101	113	125
F#	6	18	30	42	54	66	78	90	102	114	126
G	7	19	31	43	55	67	79	91	103	115	127
G#	8	20	32	44	56	68	80	92	104	116	
A	9	21	33	45	57	69	81	93	105	117	
A#	10	22	34	46	58	70	82	94	106	118	
B	11	23	35	47	59	71	83	95	107	119	

MIDI note numbers by note name and octave

Plug-Ins Tab

The plug-ins tab contains various plug-in management and behavior utilities.

All currently installed plug-ins are displayed, with one plug-in in each row. Use the vertical scroll bars to view the plug-ins that are not visible.

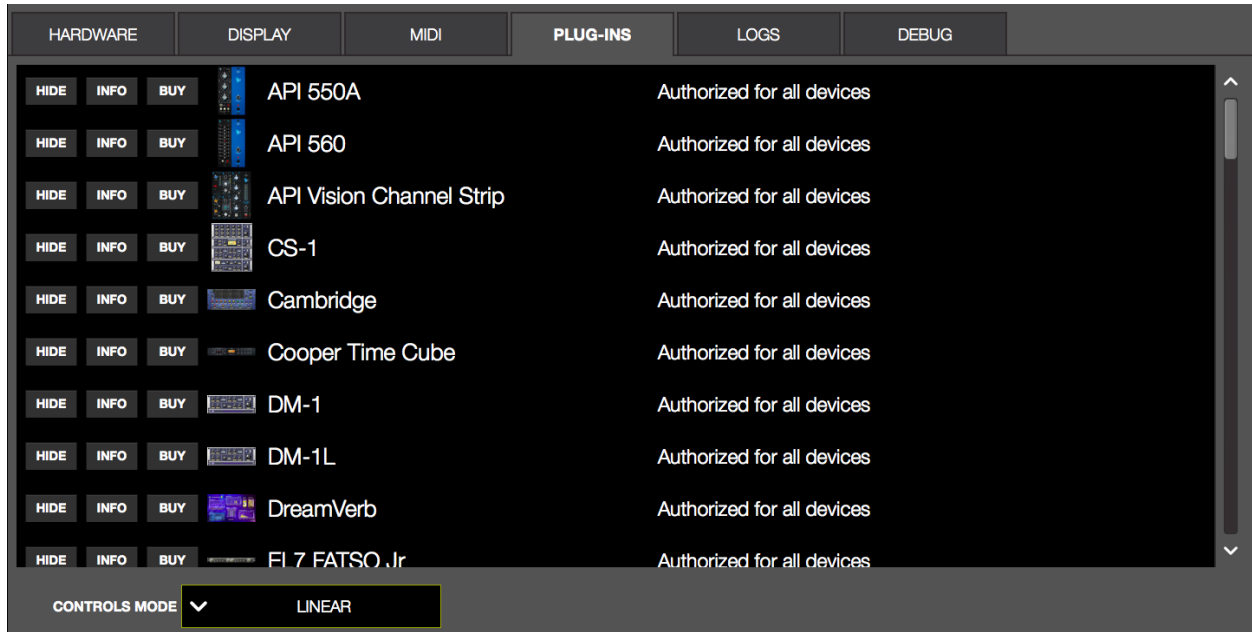

The PLUG-INS tab in Settings View

Hide Button

Prevents the plug-in from being visible in the ASSIGN tab in Channel View. To hide a plug-in, click its HIDE button. To make it visible again, click its SHOW button.

This function is used to restrict the availability of assignable plug-ins in plug-in lists. By default, all plug-ins are visible in the ASSIGN tab, even if they are unlicensed or the demo period is expired. By hiding plug-ins that are unlicensed or expired, only plug-ins that can process audio are exposed, which can be convenient for more rapid assignments.

Info Button

Opens the plug-in's product pages at uaudio.com in the default web browser, providing a general overview the plug-in.

Tip: For detailed operational info for each plug-in, see the [UAD Plug-Ins Manual](#).

Buy Button

Adds the plug-in to the shopping cart at the UA online store. Confirm you are logged in to the desired account at uaudio.com when purchasing the plug-in.

Status Column

The authorization status and/or demo state of the plug-in is displayed. The info shown here mirrors the status shown in the Plug-Ins panel within the UAD Meter & Control Panel application.

Tip: To start a plug-in demo, use the [Plug-Ins panel](#) within the UAD Meter & Control Panel application.

Controls Mode Menu

This setting determines how UAD Powered Plug-In parameter knobs respond to adjustment. To change the controls mode, click the CONTROLS MODE drop menu and choose a new value from the menu.



Three control modes are offered: Circular, Relative Circular, and Linear. The behavior of each mode is described below.

Linear (slider) – In Linear mode, the knob is adjusted by dragging horizontally or vertically instead of by rotating. This behavior is similar to moving a physical fader.

Circular (jump) – In Circular mode, the software knobs behave similar to physical rotary knobs. Values are changed by clicking on the knob then rotating in a circular direction. When the edge of the knob is clicked, the parameter value jumps to the mouse position.

Relative Circular (grab) – Relative Circular mode operates similar to Circular mode, but the knob value does not jump to the mouse position when clicked. Instead, the knob value is modified relative to its original value.

In Relative Circular mode, click anywhere on the knob to make an adjustment originating at the original value (it's not necessary to click on the current knob position).

Tip: To increase resolution when in adjusting rotary controls in circular and relative circular modes, increase the radius of the mouse relative to the knob while dragging (i.e. move the mouse farther away from the knob while dragging in a circular motion).

Soundcraft Snapshot Recall

When Snapshots are being recalled from a Soundcraft Vi Console, the majority of the features on the Snapshots page are not used. Instead, all Snapshot data is stored and recalled from the Soundcraft Vi Console.

Complete workflows within Vi Console systems is detailed in Soundcraft’s documentation, but a general outline is provided below.

Caution: When a Snapshot CUE is loaded from a Soundcraft Vi Console, the Active Snapshot is overwritten, any unsaved changes are lost, and audio artifacts could occur.

Workflow with Vi Consoles

1. Create a working Snapshot in the Realtime Rack application.
2. Add as many plug-ins as needed for a show.
3. Confirm the Soundcraft Vi Console and Realtime Rack are communicating properly via Ethernet. Proper communication is indicated on the Vi Console only (not on Realtime Rack). The indication is in the form of a UAD status LED.
4. Create a new Show (or open an existing Show) on the Vi Console.
5. In the CUE (Snapshot) list in the Vi Console, there are two dedicated UAD enable-type buttons for linking Soundcraft Cues with Realtime Rack Snapshots. Ensure that these two buttons are ON, then store the current Cue.
6. As new Cues are created, ensure that these two buttons are linked to the Cue.
7. As changes in the plug-ins are needed, hit Update Cue in the Vi Console.
8. Any parameter changes and plug-in assignments are instantly recalled when hitting the Recall button.

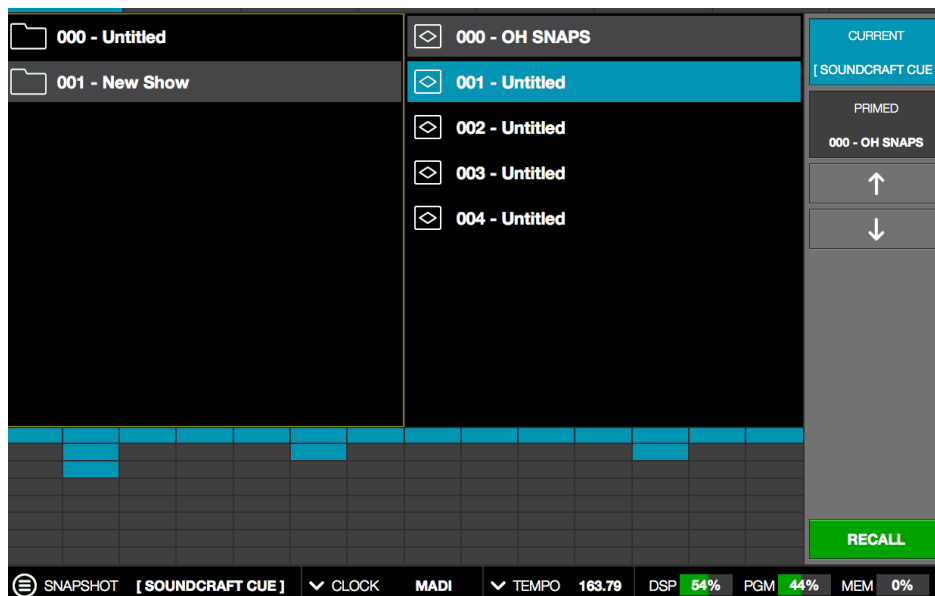

When a Snapshot is recalled remotely from a Soundcraft Vi Console, the Info Bar and Current Snapshot panel both display “[SOUNDSCRAFT CUE]”

Chapter 5: UAD Meter & Control Panel

Overview

The UAD Meter & Control Panel application is used to authorize UAD plug-ins, monitor UAD device resources, configure the global UAD Powered Plug-Ins system parameters and confirm the UAD system is operating properly. The application consists of two components: The UAD Meter, and the UAD Control Panels.



UAD Meter – This window (below) displays the current DSP, program, and memory status of the UAD hardware (these gauges are also displayed within the Realtime Rack software application).

UAD Control Panel – This window ([see page 124](#)) has multiple panels that display and modify various system, plug-in, and configuration parameters.

With Realtime Rack, the UAD Meter & Control Panel application is used primarily for UAD plug-in authorization, viewing the individual resources of multiple Realtime Rack units, and starting demo periods for UAD plug-ins.

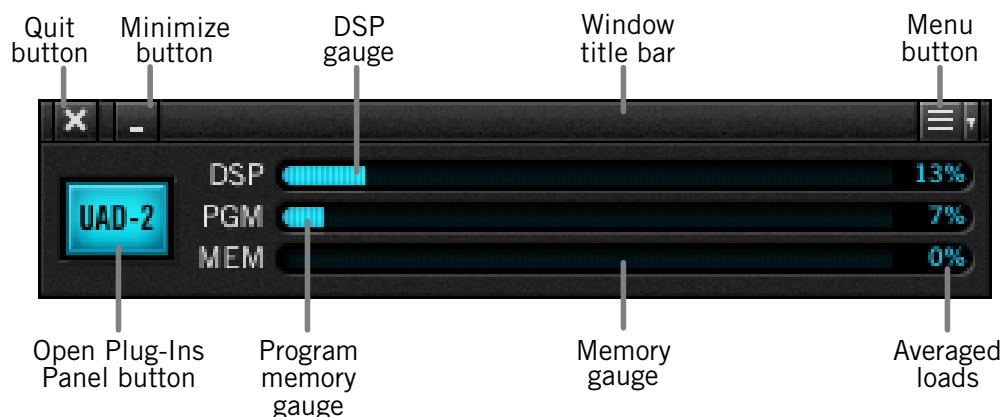

The UAD Meter window

Launching the Application

The UAD Meter & Control Panel can be opened using either of these methods:

- Single-click the UAD Meter & Control Panel icon that was placed in the Mac OS X Dock during software installation, or
- Double-click the UAD Meter & Control Panel application that was installed to: `/Applications/Universal Audio/`

Using the UAD Meter

The UAD Meter & Control Panel can be launched or quit at any time. It does not need to be open or active to use the Realtime Rack application or UAD Powered Plug-Ins; it is completely independent. You can move the UAD Meter to a convenient location on your screen by dragging its window title bar.

Note: If “No Devices Found” appears in the UAD Meter window instead of the expected buttons and gauges, the Realtime Rack drivers are not communicating with the Realtime Rack hardware unit. If this occurs, double-check the hardware and software installations, make sure the hardware is powered and connected to the computer, and/or contact customer support.

UAD Meter Elements

Refer to the diagram on [page 120](#) for these element descriptions.

Menu Button



This button opens a drop menu for accessing the UAD control panels and Always On Top mode. Single-click the menu button to display the drop menu.

Drop Menu

The drop menu is used to access the UAD control panels ([see page 124](#)). Select an item from the menu to open that panel. Alternately, you can use the keyboard commands listed in the menu as shortcut to open the control panels.



The UAD Meter Drop Menu

Always On Top

The UAD Meter window can be set to normal or “Always on top” view mode. To enable Always on top mode, click the control panel drop menu button in the Meter window title bar and select “Always on top” from the drop menu (or use the keyboard shortcut shown in the menu). The mode is active when a check mark appears next to the item in the drop menu.

Normal – In normal mode, the window can be covered by windows of the foreground application.

Always On Top – When in Always on top mode, the Meter window always “floats” on top of other windows, even when other applications are in the foreground, so you can always see the meter and access the Disable Current button. This setting is saved when the meter is quit.

Title Bar

The Title Bar (the strip across the top of the UAD Meter window) contains buttons to quit the UAD Meter & Control panel application, minimize the UAD Meter window to the Mac OS X Dock, and access the drop menu to open the UAD control panel windows.

Plug-Ins Panel Button

Clicking this button opens the Plug-Ins Panel. It has the same function as selecting “Plug-Ins...” from the Control Panel drop menu.



Resource Gauges

UAD resource loads are displayed in the UAD Meter window, which are constantly updated in realtime even when the UAD Meter is not the foreground application. This allows you to monitor UAD loads as needed, for example when deciding which UAD plug-ins to load, based upon how much DSP is available.

The UAD resources are displayed as bar graphs and as percentages.

Tip: The UAD resource gauges are also displayed within the Realtime Rack software application.

Averaged Loads

The load for each gauge represents the average for all UAD devices in use. For example, if one Realtime Rack hardware unit is installed, the UAD-2 DSP load is an average of the four SHARC DSP processors in the unit. If two units are installed, then the eight processors are averaged.

Individual Loads

The loads of individual devices in a multi-unit setup, and the individual DSP loads within a single unit) can be viewed in the UAD System Information panel ([page 124](#)).

DSP

The DSP gauges display the amount of digital signal processing resources that are being used by Realtime Rack. DSP is the hardware that powers the UAD Powered Plug-Ins algorithms.

Note: When UAD plug-ins are disabled, DSP requirements are decreased.

Program

This resource shows how much UAD-2 program memory is in use. Program memory is an on-chip memory that is specific to the UAD-2 DSP processor(s) and is used for certain UAD plug-in resources.

Each unique UAD-2 plug-in uses a bit of program memory. If many different UAD-2 plug-ins are loaded simultaneously, it is possible for this resource to run out before DSP overload occurs. This point is considered and factored in by the automatic UAD-2 load balancing routines.

Memory

The Memory gauges indicate the percentage of UAD RAM that is currently in use. It indicates the total available UAD memory available, regardless of the number of DSP processors that are installed.

Memory is used for echo, delay lines, reverb, and similar spatial processing. When UAD plug-ins are disabled but not unloaded, memory requirements are not decreased. In this case, the memory remains loaded so that reverb tails and delay lines are not cut off when the plug-in is disabled.

UAD Control Panels

The UAD Control Panel is where detailed system information is displayed and global UAD Powered Plug-Ins settings are modified. The UAD Control panel has four panels, organized into similar areas of functionality: System Information, Plug-Ins, Configuration, and Help & Support.

Note: Some controls and/or displays in the UAD Control Panels do not apply with Realtime Rack and can be ignored. They are used with Universal Audio UAD-2 devices, which also use the UAD Meter & Control Panel application. All exceptions are noted.

Accessing the Control Panels

Drop Menu

The main UAD Control Panel window is accessed from the UAD Meter window. To open the Control Panel, click the menu button in the UAD Meter window Title Bar. After clicking the menu button, the control panels are listed in the drop menu.

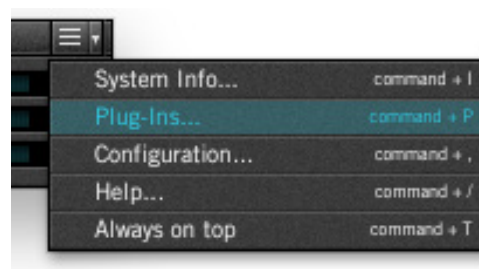

Panel Buttons

Once the main UAD Control Panel window is open, the individual window panels are accessed by clicking their respective panel title buttons.

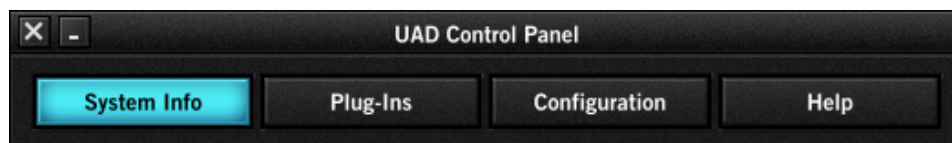

The Control Panel window panel buttons

System Information Panel

The System Information panel displays detailed UAD software and hardware information and contains several useful buttons.

Software Section

Version String

The currently installed Realtime Rack software version is displayed.

Important: *The driver and plug-in versions must match. If they don't, a “driver mismatch” error will occur when attempting to process audio. If this occurs, you must reinstall and reauthorize the Realtime Rack software.*

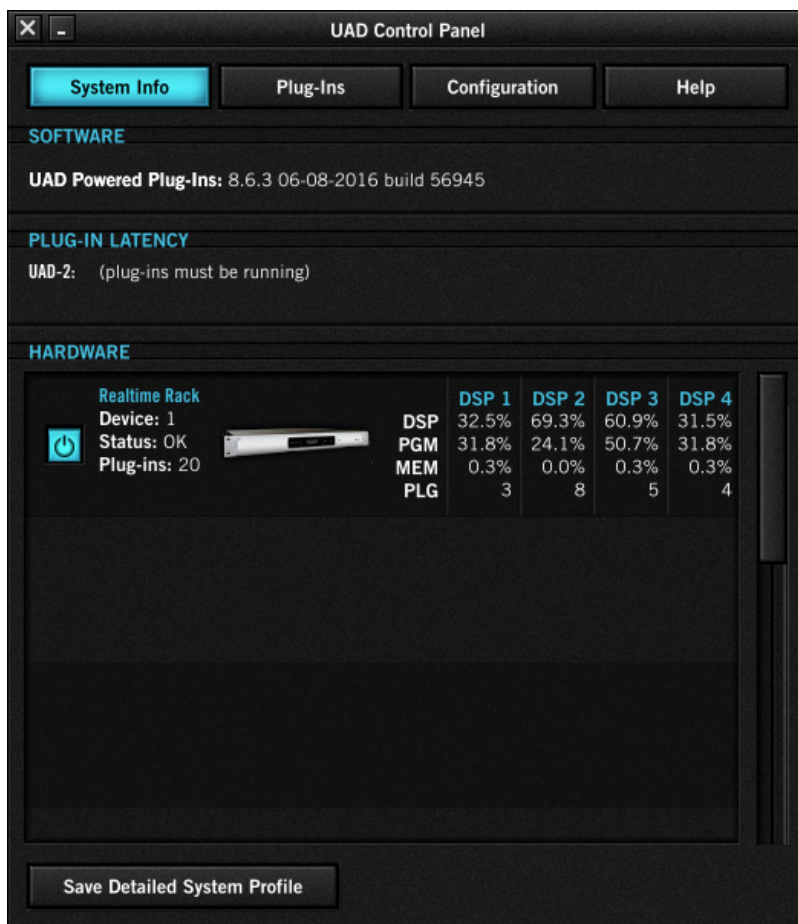

System Information panel

(Plug-In Latency Section)

Latency displayed in this section does not apply with Realtime Rack and can be ignored.

Note: *Overall system throughput latency with Realtime Rack is 73 samples when no plug-ins are assigned. See “Upsampling Values Table” on page 79 for related information.*

Hardware Section

Detailed information about each Realtime Rack unit and its DSP is displayed in the Hardware area. If you have several devices installed, use the scroll bar to see the other devices.

Device Status

For each installed device, a small picture of the hardware and its status is displayed. When the device displays Status: OK the hardware is operating properly. The total number of UAD plug-ins loaded on each device is also displayed here.

Device Enabled



Individual UAD devices can be disabled using the Device Enabled button. Click the button to disable an individual device. The device is enabled when the button is blue.

This button can be useful if creating a session on a system with multiple devices that will be transferred to a system with fewer devices, or to streamline the performance of the host computer when multiple devices are not needed.

Devices remain disabled only while the UAD Meter & Control Panel application is open. When the UAD Meter & Control Panel is quit, any disabled devices are re-enabled.

Note: *Disabling devices does not disable plug-ins already running on the device; it only prevents additional plug-ins from being loaded onto it.*

Important: *For optimum results, quit the Realtime Rack application before disabling/enabling devices.*

DSP Load

If more than one UAD DSP is installed, information for each of the processors is displayed. DSP, Program (PGM), and Memory (MEM) loads are displayed as a percentage of total available load for that processor.

The number of UAD plug-ins (PLG) running on each individual processor is also displayed.

Save Detailed System Profile

Clicking this button will generate a detailed UAD system profile and prompt you for a location to save the text file to disk. This file contains a greater level of detail than the System Information panel, which may be useful for troubleshooting, or if Customer Support requests this document when providing assistance.

The profile lists the version strings of the individual UAD software components, installed devices with serial and hardware ID numbers, host computer information, detailed authorization status for all UAD plug-ins, and other info.

Plug-Ins Panel

The Plug-Ins panel displays the current authorization status of all UAD plug-ins. This is also where you can activate Demo Mode for individual UAD plug-in (see). Use the scrollbar to view plug-ins that may not be visible in the list.

Tip: Some of the functionality of the Plug-Ins panel is duplicated/available in the Settings page within the Realtime Rack software application.

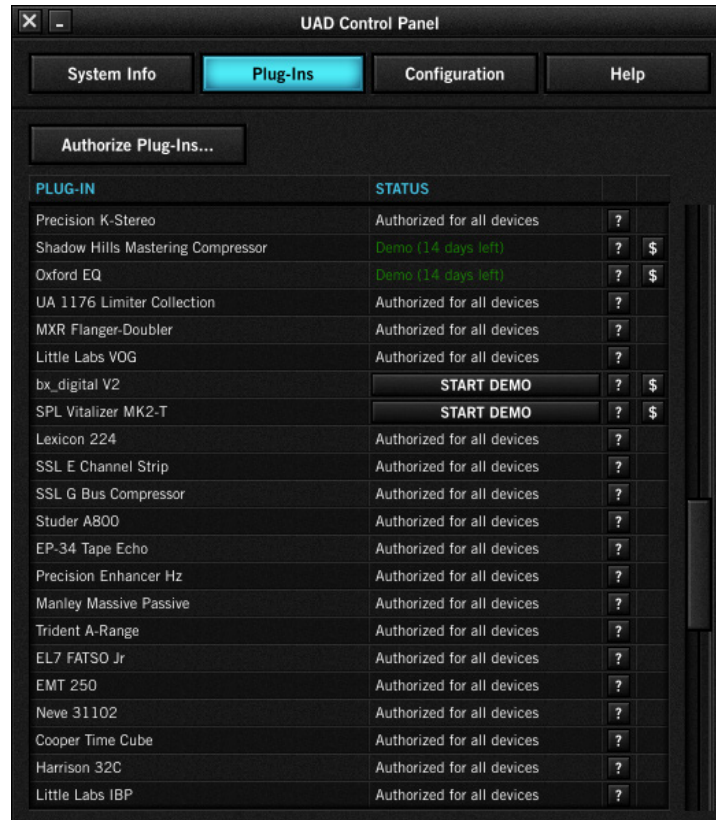

Plug-Ins panel

Authorize Plug-Ins button

This important button links directly to your account at the UA online store to authorize your licensed UAD plug-ins. If you do not already have an account, you are redirected to the registration page to create one.

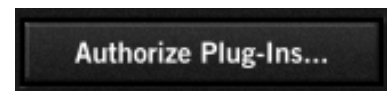

Important: UAD plug-ins require authorization before they can be used. For detailed information, see [“UAD Authorization Overview” on page 143](#). Without authorization, UAD plug-ins can be enabled to run for 14 days without functional limitations in a timed [Demo Mode](#).

The complete procedure for UAD device authorization is detailed on [page 30](#). If the computer is not connected to the internet, see the [“Offline Authorization Procedure” on page 31](#).

Plug-In Column

All currently installed UAD Powered Plug-Ins are displayed in the Plug-In column. Use the scroll bar to view the entire list if necessary.

Status Column

The Status column reflects the current state of each UAD plug-in. After the authorization file is loaded, the status will show one of the following:

Authorized for devices

When the plug-in is fully licensed and authorized to run on all devices in the system, “Authorized for all devices” is displayed here in white text.

When a plug-in is licensed but not all devices in a multi-device system are authorized with the license, the Status column indicates which of the devices is authorized (e.g., “Authorized for device 1 only”).

Start Demo

The demo period has not been started for the plug-in. Click the “START DEMO” button to begin the 14-day trial period. See [“Demo Mode” on page 144](#) for detailed information.

***Important:** The 14-day demo period for an individual UAD plug-in can only be activated once, and cannot be stopped or restarted during this period. We recommend you do not activate demo mode until you have the time to thoroughly check out the plug-in’s sound and functionality.*

Demo Active (days remaining)

If the 14-day trial period has been activated but is not yet expired, the number of days remaining is displayed here in green text.

Demo Expired

If the 14-day trial period has ended, “Demo expired” is displayed here in red text.

Help Column

Clicking the Help button (“?”) opens a link to the plug-in product page at the UA online store, which contains information about the plug-in.

Buy Column

Clicking the Buy button (“\$”) adds the plug-in to your shopping card at the UA online store. See [“Purchase Procedure” on page 145](#) for purchasing details.

***Tip:** The BUY button provides a quick visual reference to determine which plug-ins are currently authorized.*

Configuration Panel

The Configuration Panel is where most of the global UAD settings and preferences are specified for all UAD devices.

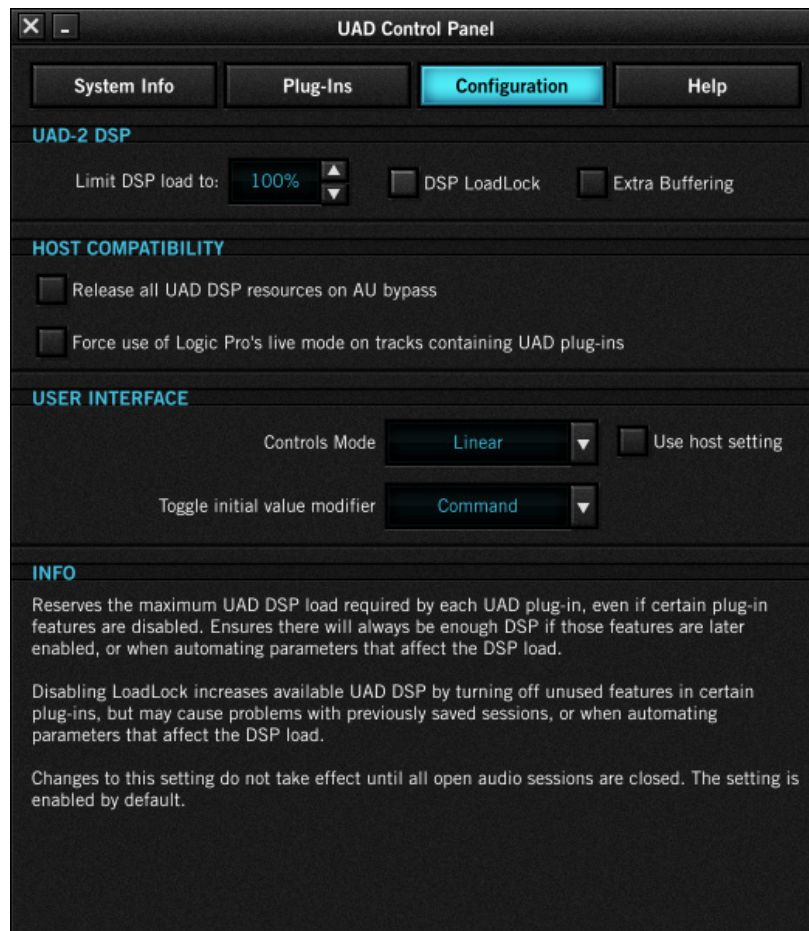

Configuration panel

UAD-2 DSP Settings

DSP Load Limiting Overview

The UAD DSP can be limited so the load cannot exceed 100%, thereby increasing overall system stability in high load situations. With very heavy UAD loads, DSP load limiting may also improve host CPU performance.

There are many variables that affect UAD DSP load (sample rate, buffer size, parameter values, mono/stereo, automation, host system, etc). Although these variables are taken into account, the resulting measurement cannot be absolutely accurate. This is due to variations in system configurations, specifically PCI/PCIe bus loading which is impossible to predict.

Systems that are heavily loaded due to the presence of other devices or suboptimal configuration may cause additional DSP loading that cannot be predicted by the UAD plug-in load calculator. The DSP load limit should be reduced in this case.

It is possible for certain (non-typical) conditions to be met where another UAD plug-in can't be added, even when the UAD Meter says you should have DSP available when compared to the DSP Load Limit value.

***Note:** When Limit DSP Load is enabled and the DSP load limit is exceeded when instantiating a new UAD plug-in, an overload message will appear and the plug-in status bar will display "DISABLED." Even though its interface will load in this state, the plug-in will not process audio.*

Limit DSP Load

This setting determines the maximum UAD DSP load. If performance issues such as overloads, dropouts, stuttering, and/or crackles persist, change the UAD DSP load value by clicking the triangles to the right of the percentage display.

UAD-2 DSP load limiting is always on. 100% (the default value) is the maximum available setting.

DSP LoadLock

DSP LoadLock reserves the maximum UAD-2 DSP load required by each plug-in, even if certain plug-in features are disabled. This ensures there will always be enough DSP if those features are later enabled, or when automating parameters that affect the DSP load.

Disabling LoadLock increases available UAD-2 DSP by turning off unused features in certain plug-ins, but may cause problems with previously saved sessions that had all plug-in features enabled, or when automating parameters that affect the DSP load.

Enabling DSP LoadLock is recommended for optimum performance. Disable LoadLock when you need to squeeze in that extra bit of DSP resources.

***Note:** Changes to this setting do not take effect until all open sessions containing UAD plug-ins are closed.*

(Extra Buffering)

***Note:** This setting does not apply to Realtime Rack and can be ignored.*

(Host Compatibility Settings)

***Note:** Both settings in this area do not apply to Realtime Rack and can be ignored.*

(Release all DSP resources on Audio Unit bypass)

(Force Logic to use "live mode" for tracks with UAD plug-ins)

User Interface Settings

Controls Mode

This setting determines how UAD Powered Plug-In parameter knobs respond to adjustment. Three control modes are offered: Circular, Relative Circular, and Linear. Select the desired mode from the drop menu. The behavior of each mode is described below.

Linear (slider) – In Linear mode, the knob is adjusted by dragging horizontally or vertically instead of by rotating. This behavior is similar to moving a physical fader.

Circular (jump) – In Circular mode, the software knobs behave similar to physical rotary knobs. Values are changed by clicking on the knob then rotating in a circular direction. When the edge of the knob is clicked, the parameter value jumps to the mouse position.

Relative Circular (grab) – Relative Circular mode operates similar to Circular mode, but the knob value does not jump to the mouse position when clicked. Instead, the knob value is modified relative to its original value.

In Relative Circular mode you can click anywhere on the knob to make an adjustment originating at the original value. You don't have to click on the current knob position.

***Tip:** To increase resolution when in adjusting rotary controls in circular and relative circular modes, increase the radius of the mouse relative to the knob while dragging (i.e. move the mouse farther away from the knob while dragging in a circular motion).*

Use Host Mode

***Important:** This box should remain UNCHECKED with the Realtime Rack system.*

When Use Host Mode is checked, the control mode set within the host application preferences is used if this feature is supported by the host. This setting forces the host to override the control mode set in the UAD user interface settings.

***Note:** When Use Host Mode is checked, the UAD Meter user interface settings have no effect unless control mode is NOT supported by the host.*

Toggle initial value modifier

Holding the specified modifier key while clicking a parameter control will toggle between the value of the control when the editor was opened and its last edited value.

This parameter also affects the “select + click” modifier. For a complete list of keyboard shortcuts for plug-ins, see [page 135](#).

Info Display

This area displays helpful text about parameters in the Configuration panel. Hover the mouse over a Configuration setting to view the informational text.

Help & Support Panel

The Help & Support panel contains numerous helpful weblinks to help you get the most out your Realtime Rack experience.

The button names are self-explanatory. Click a button to launch the URL in your default web browser (you must be connected to the internet to launch the web pages). If the UAD computer isn't online, much of the information is in the manual you're reading now; find it in the Table of Contents, Index, or PDF search.

View Documentation is the only button that doesn't link to the internet. Instead, clicking this button opens the Documentation folder containing all the PDF user manuals at / Applications/Universal Audio (see "[Documentation Overview](#)" on page 18).

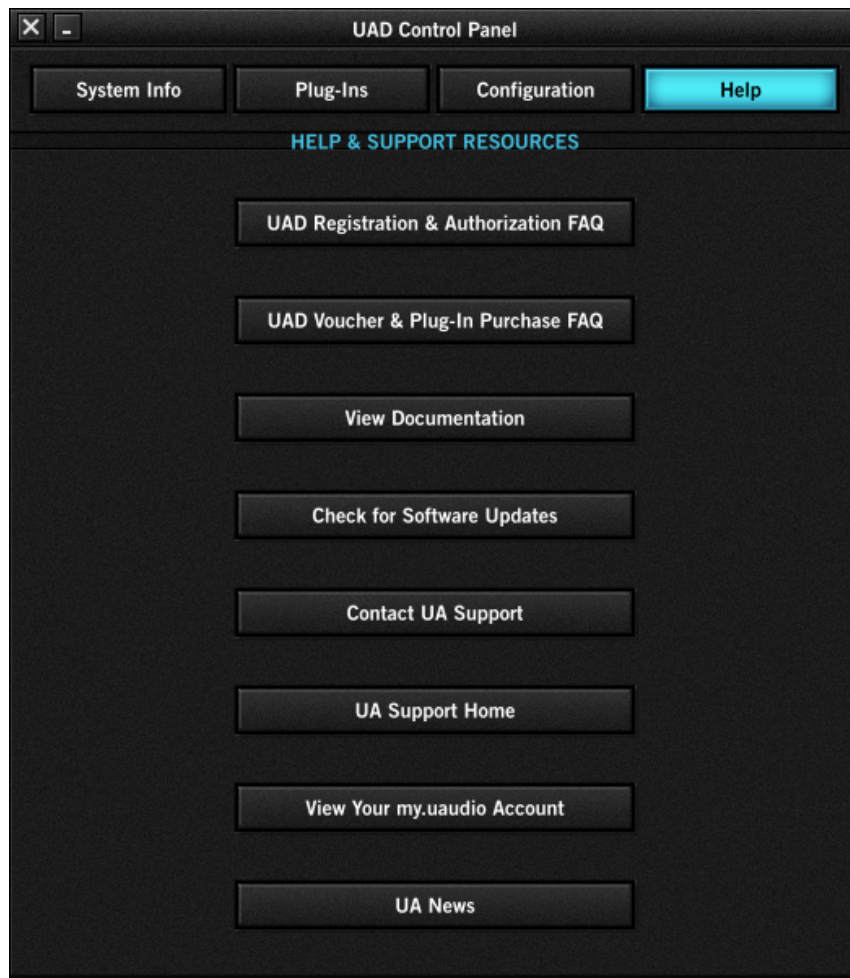

Help & Support panel

Chapter 6: Using UAD Powered Plug-Ins

Note: This chapter provides a global overview of UAD plug-in operation. Complete operating instructions for individual plug-ins are in the UAD Plug-Ins Manual.

The UAD Plug-In Window

A typical UAD plug-in window is shown below. The graphical user interface (GUI) typically contains several control parameters for modifying the behavior of the plug-in, and display elements such as meters, for visual feedback.



Typical UAD plug-in window

Status Bar

Under certain conditions, information about the current operating state of individual UAD plug-ins is displayed in a status bar beneath the main plug-in window. The status bar states are as follows:

Not shown – The plug-in is authorized and operating normally.

Not Authorized – The plug-in authorization is not current or the demo is not yet started.

Demo – The demo period is active; days remaining in the demo are displayed.

Powered Off – The plug-in is inactive. It has been disabled via the Power button in single plug-in view or from the Inserts view.

Note: *Powered Off* does not appear if the plug-in is disabled from within its GUI window.

Disabled – The plug-in is not running because there were not enough available UAD DSP resources when attempting to load the plug-in or the demo period is expired.



The UAD plug-in status bar (at bottom)

Adjusting Parameters

The parameter settings within each UAD Powered Plug-In can be adjusted to achieve a desired effect. Parameter values are easily modified by dragging sliders, rotating knobs, clicking switches and buttons, or by selecting values in a drop-menu. The functions of all parameters are detailed in the UAD Plug-Ins Manual.

The parameter adjustment style can be Circular, Relative Circular, or Linear. For more information, see [“Controls Mode Menu” on page 118](#).

Note: To increase resolution when adjusting rotary controls in circular and relative circular modes, increase the radius of the mouse relative to the knob while dragging (i.e. move the mouse farther away from the knob while dragging).

Text Entry

Parameter values can be modified directly with text entry. To enter a parameter value using text entry, single-click the parameter value text. The text value will highlight, indicating it is ready to receive a new value. Type in a new value, then press Return, Enter, or Tab, or click outside of the text box. Press Esc if you want to revert to the prior setting without entering the new value.

Values entered via text entry are rounded to the closest significant digit. If an entered value is out of range, it will be ignored.

To enter time values, the units must be specified. m = milliseconds, and s = seconds. Examples: 400 milliseconds = 0.400s or 400m; 1.5 seconds = 1.5s or 1500m.

Scroll Wheel

If your mouse has a scroll wheel, it can be used to adjust knob and slider controls if the host application supports this functionality. Place the mouse cursor over any knob or slider control to increment or decrement the parameter value with the scroll wheel.

Keyboard Control

If you control-click a control it selects that control for keyboard control. This is useful for when you're in circular mode, and you want to fine-adjust a control. Normally, clicking on a control in this mode makes the value jump to where you clicked. Control-clicking will select the control so that you can use the keyboard to adjust it, without making its value jump first.

Shortcuts

The table below lists the keyboard shortcuts that are available for modifying parameter values. When using keyboard shortcuts, the last edited control will be modified (or, on Mac, you can use control-click to select a different control as the target for keyboard shortcuts without changing the control's value).

Keyboard Action:	Result:
Control + Click Parameter (Mac only)	Select parameter for keyboard control (without changing its value)
Shift + Drag	Fine Control
Up Arrow Right Arrow Shift + Page Up	Increment Fine
Down Arrow Left Arrow Shift + Page Down	Decrement Fine
Shift + Up Arrow Shift + Right Arrow Page Up	Increment Coarse
Shift + Down Arrow Shift + Left Arrow Page Down	Decrement Coarse
Modifier* + Click parameter (*Modifier key set in Configuration Panel)	Toggle initial editor setting (the value when the editor window was last opened)
Modifier* + Shift + Click parameter (*Modifier key set in Configuration Panel)	Revert to initial editor setting (the value when the editor window was last opened)

UAD plug-in keyboard control shortcuts

DSP Loading Information

- Each Realtime Rack hardware unit features four on-board SHARC DSP chips for processing UAD Powered Plug-Ins.
- Multi-unit Realtime Rack systems use sophisticated load balancing routines. UAD plug-ins are always allocated as efficiently as possible, which is not necessarily on the DSP with the lowest resource usage.
- UAD DSP usage is proportional to the system sample rate. Therefore, more plug-ins can be used simultaneously in a 44.1K session than in a 96K session.
- Bypassing individual components will conserve DSP on some UAD plug-ins. For example, bypassing the compressor in the EX-1 when only the EQ is in use, and/or bypassing any of the unused bands of the EX-1 EQ will use less UAD DSP (unless DSP LoadLock is enabled).
- The UAD DSP resources required by each successive UAD Powered Plug-In instance will slightly decrease.
- A chart showing expected plug-in counts can be found on our website: uaudio.com/support/uad/compatibility/instance-chart.html

Operating Levels

Except as noted in the table below, the internal operating level of most UAD Powered Plug-Ins is typically -18 dBFS. 0 dBFS is calibrated to +4 dBu with 18 dB of headroom, so 0 dBFS is the equivalent of +22 dBu in the analog domain.

UAD Plug-In Title	Internal Operating Level	0 dBFS Equivalent
Most Titles	-18 dBFS	+22 dBu
Ampex ATR-102 Studer A800 Teletronix LA-2A Limiter Collection	-12 dBFS	+16 dBu
Manley Massive Passive	-14 dBFS	+18 dBu
Neve 33609 (selectable)	-14 dBFS -18 dBFS -22 dBFS	+18 dBu +22 dBu +26 dBu

UAD plug-in internal operating levels

Tempo Sync

Overview

The time-based parameters of numerous UAD Powered Plug-Ins can be synchronized to the tempo of the Realtime Rack software using the Tempo Sync feature.

Note: The tempo used by UAD plug-ins that are set to Tempo Sync is specified in the Settings>MIDI panel within the Realtime Rack software application.

When Tempo Sync is activated, the time-based parameters that are available for synchronization are changed to note duration values, and will sync to the tempo of the host application using the displayed note value.



Tempo Sync switch within Precision Delay Mod

Tempo Sync Plug-Ins

Tempo Sync is supported in the UAD plug-ins listed in the table below.

CS-1	MXR Flanger/Doubler
Cooper Time Cube	Precision Delay Mod
EP-34	Precision Delay Mod L
Moog Filter	Precision Reflection Engine
Moog Filter SE	Roland RE-201

Sync Activation

To activate Tempo Sync, click the “Sync” button within the plug-in interface. The Sync button will illuminate and the time parameters will change from a time-based display to a note value, as shown in the screenshot above.

Note: When Tempo Sync is activated, the plug-in will automatically switch the time or rate parameter(s) to the nearest available note value(s) given the range of the parameter in question and the current tempo.

Available Tempo Sync Note Values

The note values that are available for selection are listed in the table below. The values are listed in musical notation as a division of measures. For example 1/4 = one quarter note, 1/1 = one whole note, 4/1 = four whole notes, and so forth.

The available note values were chosen to allow syncing to tempo in odd time signatures as well the common 4/4 time signature.

LFO rate parameters have their note values listed from longest to shortest, since long note values correspond to slow LFO rates.

1/64D*	1/8	5/8	4/1	D = Dotted T = Triplet * = RE-201 only
1/64	5/32*	1/1T	5/1	
1/32T	1/4T	1/2D	6/1	
1/32	1/8D	1/1	8/1	
1/16T	1/4	5/4	9/1	
1/32D	5/16	1/1D	12/1	
1/16	1/2T	7/4	16/1	
1/8T	1/4D	2/1		
1/16D	1/2	3/1		

Tempo Sync available note values

A quarter note is always a quarter note, independent of the time signature. In different time signatures a quarter note can represent different numbers of musical beats (for example, 6/8) or different fractions of a bar (such as 5/4). For example, say the time signature is 6/8 and the delay time tempo sync note value is 1/4. If a sound occurs on beat one of the measure then its delay will occur on beat 3, which is 1/4 note (i.e., two 8th notes) later.

Note: *The tempo BPM value in Realtime Rack's tempo setting always refers to a quarter note, independent of time signature.*

Range Limits

Some Tempo Sync parameters cannot access the entire note range in [Available Tempo Sync Note Values](#). Because the original (non-tempo sync) range of the time-based parameters within each plug-in is limited, if the host tempo is too fast or too slow, the tempo sync note value may not be able to be achieved within the constraints of the original parameter.

Out of range

When a parameter note value is out of range of the current tempo note value, the note value is displayed in parentheses. In this case, the parameter's minimum (slow tempo) or maximum (fast tempo) value is used instead of the displayed value.



Tempo Sync value out of range (parentheses)

Entering Tempo Values

In addition to adjusting the parameter knob, the two following methods can be used for entering Tempo Sync values.

Arrow Keys

After clicking the parameter to select it, the arrow keys can be used to scroll through available note values.

Text Entry

Direct text entry is also available (see [“Shortcuts” on page 135](#)). Any notation values can be entered (fraction or decimal), and the values are automatically converted to the nearest appropriate setting.

For example: If $3/4$ or $6/8$ is entered using text entry, $1/2D$ is displayed because a dotted half note equals three quarter notes, which is the duration of one measure in a time signature of $3/4$ or $6/8$. If $12/8$ is entered with text entry, $1/1D$ is displayed because a dotted whole note equals six quarter notes, which is the duration of one measure in a time signature of $12/8$ (or two measures in a time signature of $3/4$ or $6/8$).

This means you can create a tempo sync duration of one measure for any time signature by simply typing in the time signature (assuming there is a match in the beat table).

Similarly, if $1/12$ is entered with text entry, $1/8T$ is displayed because an eighth note triplet is equivalent to one-twelfth of a measure (if in $4/4$ time).

Precision Delay Modes with Tempo Sync

The UAD Precision Delay Mod and UAD Precision Delay Mod L plug-ins have a Mode menu that switches the plug-in operation between delay, chorus, and flanger mode. In these plug-ins, when the Mode is set to DUAL DELAY and PING PONG, the delay Time and modulation Rate parameters are simultaneously available for Tempo Sync.

However, when the plug-in is set to a CHORUS or FLANGER mode, only the Rate is available for Tempo Sync. This enables the more typical and musical chorus/flange effect by only syncing the modulation Rate to the tempo while the delay time remains constant.

Roland RE-201 Sync

When the RE-201 is in Tempo Sync mode, note values can be imprecise due to the fixed tape head relationships.



Values that are imprecise approximations (but are within the available delay time range) are displayed with a “+” or “-” symbol. The leading head in the current mode is accurately synced; the other values are based on the fixed tape head relationship. Note that when a parameter note value is out of range of the current tempo note value, the note value flashes (instead of in parentheses on a red background).

Note: When a parameter note value is out of range of the current tempo note value in RE-201, the note value flashes instead of in being parentheses.

Chapter 7: UA Online Store

UA Store Overview

The Universal Audio online store is where optional UAD plug-in licenses are purchased and where UA coupons are redeemed. [My.Uaudio](#) is where your UA account and its associated UAD devices (including Realtime Rack) are managed. This chapter provides complete details about the UA online store, My.Uaudio, and UAD authorization.

Optional Plug-Ins

Most UAD Powered Plug-Ins require optional licenses to run without restrictions. Optional plug-in licenses are obtained at the UA online store.

Bundled Plug-Ins

UAD plug-ins licenses that are bundled (included) with the UAD device are automatically issued to your My.Uaudio account when the device is registered. After registration is complete, the bundled plug-ins are authorized.

***Note:** UAD devices must be registered to run bundled plug-ins.*

Plug-Ins are already installed

The UAD software installer always installs the complete suite of available UAD plug-ins during installation. When you purchase an optional license, you don't download that individual plug-in. Instead, you simply re-authorize your system, which activates the plug-in file that is already installed.

***Important:** Older versions of UAD software may not include all the latest UAD plug-ins. To ensure all UAD plug-ins are installed, and for optimum performance, update to the latest UAD version.*

Coupons

Coupons issued during device registration and/or in promotional emails have dollar values that are as “good as cash” for buying UAD plug-ins. Coupons are virtual (not printed) and are applied to your registered account automatically. The coupon dollar amount is in your My.Uaudio account as a credit, ready to be applied to your store purchase.

Coupons expire after a limited time period, and they can be used only once.

***Tip:** Coupons are a great reason to subscribe to UA promotional announcements. Email subscription preferences are specified on your My.Uaudio Profile page.*

My.Uaudio

[My.Uaudio](#) is where your UA account and its associated UAD devices (including Realtime Rack) are managed. All UAD device registrations and plug-in authorizations are managed here as well.

My.Uaudio can be accessed from most pages at www.uaudio.com by clicking the My.Uaudio link in at the upper right of a uaudio.com webpage.

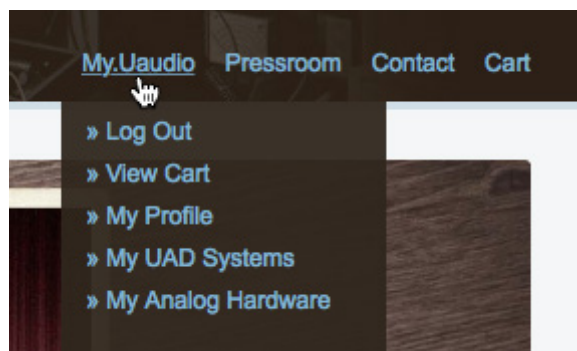

Accessing My.Uaudio at www.uaudio.com

Registration

Hardware device registration at is required to obtain UAD device authorizations, redeem coupons, purchase optional UAD plug-in licenses, get software updates, and receive customer support. You can also opt-in to receive important news and product announcements via email during registration.

The UA account creation and UAD device registration process is triggered automatically when a new UAD device is recognized by the UAD software. Our web pages guide you through the process.

UA Account

A free My.Uaudio account is required to register and authorize UAD devices. The first time you visit My.Uaudio you are prompted to create an account. Your email address is your account login. You'll need to choose a password and set your email notification preferences.

When you revisit My.Uaudio, you are prompted to login to your account. If you forget your password you can have the store email a new password to you. You have the option to stay logged in (via a browser cookie) so you don't have to enter credentials with each visit.

My Profile

[My Profile](#) is where account details such as your name, email address, and email subscription preferences are stored and edited.

UAD Authorization Overview

Note: This section is an overview of the entire UAD authorization system. For the step-by-step authorization instructions, see [Device Registration & Authorization](#).

My Systems

The UAD devices and plug-ins that you own can be found on your My Systems page at www.uaudio.com/my/systems. My Systems keeps track of your registered UAD devices and UAD plug-in licenses and is managed automatically by the UA online store and the UAD software.

Tip: The current UAD plug-in license state is also shown in the [Plug-Ins Panel](#) within the UAD Meter & Control Panel application.

UAD System

All UAD devices registered to a My.Uaudio account, and all UAD plug-in licenses for those devices, is referred to as a *System* on the My Systems page. Licensed UAD plug-ins are only authorized to run on the UAD devices associated with the same account.

Account Creation and Device Registration

Creating a My.Uaudio account and registering the UAD hardware is only needed once during initial device installation. After registration, authorization is performed within the UAD Meter & Control Panel application by clicking the [Authorize Plug-Ins](#) button.

Adding Additional UAD Devices

If a second (or more) UAD device is added to the computer that already has the UAD software installed, the new device(s) is automatically detected by the UAD software. Upon detection, the web browser opens and the device is added to your account.

Authorizing Newly-Purchased UAD Plug-Ins

When a UAD plug-in is purchased at the UA store, it needs to be manually authorized. The store guides you through the process; see [Buying Plug-Ins](#) for detailed procedures.

Authorizations Are Stored On UAD Device

During authorization, the UAD plug-in license state is stored on the UAD device. If the unit is moved to another computer, it is not necessary to reauthorize the device.

Demo Mode

All unlicensed UAD plug-ins include a free 14-day trial evaluation period. When the demonstration mode is activated, the plug-in will run without functional limitations for 14 days. Demo mode can be activated once only. After the demo trial period has expired, demo mode cannot be activated again on the same UAD device.

If an unlicensed plug-in is loaded and its demo has never been started, a dialog appears with instructions to start the demo and the option to visit the online store to purchase the license. If you don't start the demo or purchase a license, the plug-in interface appears and can be manipulated, but audio is not processed by the plug-in.

Important: *The 14 day demo period can only be activated once, and cannot be stopped or restarted during this period. Activate demo mode only when you have adequate time to thoroughly evaluate its sound and functionality.*

Demo Reset

As a courtesy, each time a new UAD plug-in is purchased, all expired demo periods are automatically reset so all UAD plug-ins with expired demos can be evaluated again.

Demo Activation

To activate demo mode:

1. Ensure Realtime Rack is already installed and configured properly (see [Chapter 3: System Setup](#)).
2. Open the [Plug-Ins Panel](#) within the UAD Meter & Control Panel application.
3. Locate the row for the UAD plug-in you want to evaluate (scroll if necessary).
4. In the [Status Column](#), click the START DEMO button for the UAD plug-in. A confirmation window appears and the timed demo can be activated or demo activation can be cancelled.

Important: *Manipulating the computer's system date and time will result in a decreased demo period.*

Buying Plug-Ins

To obtain optional UAD plug-in licenses, simply visit www.uaudio.com, browse the complete line of plug-ins at our secure online store, and complete your purchase with several payment options. You can also use any coupon credit that was applied during device registration or promotional offers.

Lots of product information such as features, specifications, audio/video examples, and reviews are available on the plug-in product pages at the store to help you make informed buying decisions.

Purchase Procedure

To purchase and authorize optional UAD plug-ins:

1. Visit the UA online store at www.uaudio.com.
2. Add the items you want to purchase to your shopping cart (you may need to login to your [UA Account](#)).
3. Click “View cart” or the Checkout button when ready to proceed to checkout. The payment page appears.
4. Select payment method and provide payment details. If applicable, apply any discount coupon codes.
5. Click the Continue button. The order confirmation page appears.
6. Verify the order on the confirmation page, then click Confirm Order **once only**. The transaction is processed, and the Checkout Success page appears. Purchased UAD plug-in licenses are issued immediately to your my.uaudio account. Any authorization occurring after this point contains the license for the newly purchased plug-in(s).
7. Open the UAD Meter & Control Panel application (see [Launching the Application](#) for methods).
8. Access the [Plug-Ins Panel](#) within the application by clicking the blue UAD-2 button in the UAD Meter window.

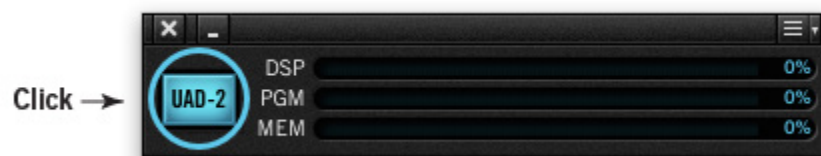

9. Click the Authorize Plug-ins button in the Plug-Ins panel.



10. After a few moments the Authorization Status window appears.

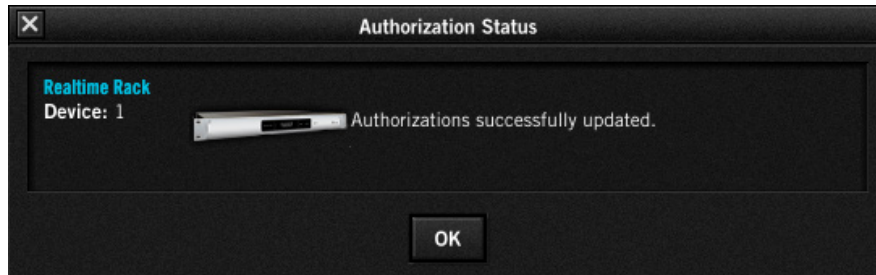

The purchased UAD plug-in is now authorized and ready for use.

Transferring UAD devices and licenses

Ownership of UAD devices and UAD plug-in licenses can be transferred from one My.Uaudio account to another to accommodate the used equipment marketplace. Certain restrictions apply. Please visit the UAD transfer page for instructions, policies, and FAQ:

- help.uaudio.com

Transfer Video

Our Videos page has a video about UAD device transfers:

- www.uaudio.com/videos

Chapter 8: Specifications

SYSTEM	
<i>I/O Complement</i>	
Thunderbolt	Dual ports (Thunderbolt 2 compatible)
Word Clock	One input, one output
MADI Optical Ports	One input, one output
Supported Sample Rates (kHz) (48 kHz only with Soundcraft Vi console)	44.1, 48, 88.2, 96 (one or two units) 44.1, 48 (up to four units)
Bit Depth	24 bits per sample
System Throughput Latency @ 48 kHz	73 samples
DIGITAL I/O	
<i>MADI</i>	
Connector Type	MADI - Dual Optical SC-Plug (ISO/IEC 9314-3)
Format	AES10 (64 channels)
Supported Modes @ Sample Rates of 88.2/96 kHz	Standard, Legacy
<i>Word Clock</i>	
Connector Type	BNC
Lock Range	±0.5% of any supported sample rate
Word Clock Input Termination	75 Ohms, switchable
<i>Synchronization Sources</i>	
Internal, Word Clock, MADI	
ELECTRICAL	
Power Supplies	Dual-redundant internal power supply units with automatic failover detection
AC Connector Type	Male IEC with integrated power switch
AC Requirements	100V – 240V AC, 50 – 60 Hz, 0.3A
Maximum Power Consumption	30 Watts 45 Watts (when bus powering external Thunderbolt peripheral)

(continued)

ENVIRONMENTAL

Operating Temperature Range	0° Celsius to +45° Celsius
Storage Temperature Range	-40° Celsius to 80° Celsius
Operating Humidity Range	60% Maximum

MECHANICAL***Dimensions***

Chassis (W x D x H)	431.8 mm (17") x 304.8 mm (12") x 33.8 mm (1.3")
Height	1U

Weight

Shipping Weight (with box & accessories)	6.3 kg (14 lbs)
Weight (unit only)	4.1 kg (9 lbs)

Package Contents

Soundcraft Realtime Rack hardware unit
(2) IEC AC Power Cables (1 each, Europe & USA)
Getting Started sheet
Set of (4) Rack-Mount Screws

Chapter 9: Notices

Maintenance

Realtime Rack does not contain a fuse or other user-replaceable parts. The unit is internally calibrated at the factory and recalibration should never be required. No internal user adjustments are available.

Warranty & Repair

The Realtime Rack hardware warranty and repair service is provided by Soundcraft.

Contact Soundcraft to obtain technical support for configuration and operation of Vi-series consoles, including how to setup and operate Vi-series consoles with Realtime Rack.

Products Under Warranty

UK customers should contact their local dealer.

Customers outside the UK are requested to contact their territorial distributor who is able to offer support in the local time zone and language. Please see the distributor listings on our website (www.soundcraft.com) to locate your local distributor.

Out-Of-Warranty Products

For out-of-warranty products purchased in the United Kingdom, please contact the Customer Services Department (e-mail: soundcraft.csd@harman.com) at the factory in Potters Bar, Hertfordshire: Telephone +44 (0)1707 665000.

For all other out-of-warranty products, please contact the appropriate territorial distributor.

When mailing or faxing please remember to give as much information as possible. This should include your name, address and a daytime telephone number. Should you experience any difficulty please contact Customer Services Department (e-mail: soundcraft.csd@harman.com).

Important Safety Information

Before using this unit, be sure to carefully read the applicable items of these operating instructions and the safety suggestions. Afterwards, keep them handy for future reference. Take special care to follow the warnings indicated on the unit, as well as in the operating instructions.

Water and Moisture – Do not use the unit near any source of water or in excessively moist environments.

Object and Liquid Entry – Care should be taken so that objects do not fall, and liquids are not spilled, into the enclosure through openings.

Ventilation – When installing the unit in a rack or any other location, be sure there is adequate ventilation. Improper ventilation will cause overheating, and can damage the unit.

Heat – The unit should be situated away from heat sources, or other equipment that produces excessive heat.

Power Sources – The unit should be connected to a power supply only of the type described in the operating instructions, or as marked on the unit.

Power Cord Protection – AC power supply cords should be routed so that they are not likely to be walked on or pinched by items placed upon or against them. Pay particular attention to cords at plugs, convenience receptacles, and the point where they exit from the unit. Never take hold of the plug or cord if your hand is wet. Always grasp the plug body when connecting or disconnecting it.

Grounding of the Plug – This unit is equipped with a 3-wire grounding type plug, a plug having a third (grounding) pin. This plug will only fit into a grounding-type power outlet. This is a safety feature. If you are unable to insert the plug into the outlet, contact your electrician to replace your obsolete outlet. Do not defeat the purpose of the grounding-type plug.

Cleaning – Follow these general rules when cleaning the outside of the unit:

- a. Turn the power off and unplug the unit
- b. Gently wipe with a clean lint-free cloth
- c. Do not use aerosol sprays, solvents, or abrasives

Nonuse Periods – The AC power supply cord of the unit should be unplugged from the AC outlet when left unused for a long period of time.

Damage Requiring Service – The unit should be serviced by a qualified service personnel when:

- a. The AC power supply unit has been damaged; or
- b. Objects have fallen or liquid has been spilled into the unit; or
- c. The unit has been exposed to rain; or
- d. The unit does not operate normally or exhibits a marked change in performance; or
- e. The unit has been dropped, or the enclosure damaged.

Servicing – The user should not attempt to service the unit beyond that described in the operating instructions. All other servicing should be referred to qualified service personnel.

FCC Compliance

Federal Communications Commission

United States Class B Manual Statement

NOTE: This equipment has been tested and found to comply with the limits for a Class B digital device pursuant to Part 15 of the FCC Rules. These limits are designed to provide reasonable protection against harmful interference in a residential installation. This equipment generates, uses, and can radiate radio frequency energy and, if not installed and used in accordance with the instructions, may cause harmful interference to radio communications. However, there is no guarantee that interference will not occur in a particular installation. If this equipment does cause harmful interference to radio or television reception, which can be determined by turning the equipment off and on, the user is encouraged to try and correct the interference by one or more of the following measures:

- Reorient or relocate the receiving antenna.
- Increase the separation between the equipment and the receiver.
- Connect the equipment into an outlet on a circuit different from that to which the receiver is connected.
- Consult the dealer or an experienced radio/TV technician for help.

Hardware Terms and Conditions

Use of the Realtime Rack hardware is governed by the Universal Audio, Inc. Hardware Terms and Conditions, which is published at:

- www.uaudio.com/hardware-terms.html

Software End User License Agreement

Use of the Realtime Rack software is governed by the Universal Audio, Inc. Software End User License agreement, which is published at:

- www.uaudio.com/eula-ua.html

Disclaimer

The information contained in this manual is subject to change without notice. Universal Audio, Inc. makes no warranties of any kind with regard to this manual, including, but not limited to, the implied warranties of merchantability and fitness for a particular purpose. Universal Audio, Inc. shall not be liable for errors contained herein or direct, indirect, special, incidental, or consequential damages in connection with the furnishing, performance, or use of this material.

Trademarks

Universal Audio, the Universal Audio diamond logo, UAD, UAD Series, UAD-1, UAD-2, UAD-2 SOLO, UAD-2 DUO, UAD-2 QUAD, UAD-2 OCTO, Powered Plug-Ins, 1176LN, 1176SE, Teletronix, LA-2A, LA-3A, LA-610, LA-610MkII, 2-1176, 610, 2-610, 6176, 710 Twin-Finity, 2192, 4-710d, Cambridge EQ, DreamVerb, Plate 140, Precision Limiter, RealVerb Pro, Precision Buss Compressor, Precision De-Esser, Precision Maximizer, Satellite, Satellite DUO, Satellite QUAD, Apollo, Apollo DUO, Apollo QUAD, Apollo 16, Analog Ears I Digital Minds and Helios, are trademarks or registered trademarks of Universal Audio, Inc.

Other company and product names mentioned herein are trademarks of their respective owners.

Copyright

Copyright ©2016 Universal Audio, Inc. All rights reserved.

This manual and any associated software, artwork, product designs, and design concepts are subject to copyright protection. No part of this document may be reproduced, in any form, without prior written permission of Universal Audio, Inc. Your rights to the Software are governed by the accompanying End User License Agreement.

Chapter 10: Technical Support

Technical support for Realtime Rack is separated by areas of functionality. Support for Realtime Rack *hardware* and Vi Series *console integration* is provided by Soundcraft. Support for Realtime Rack *software* is provided by Universal Audio.

Soundcraft: Support for Vi Series Consoles and Realtime Rack Hardware

Contact Soundcraft to obtain technical support for configuration and operation of Vi Series consoles, including how to setup and operate Vi Series consoles with Realtime Rack.

Soundcraft Tech Support (UK)

- Phone: +44 (0) 1707 665000
- Email: csd@soundcraft.com
- Web: [Soundcraft Support](#)

Soundcraft Tech support (USA)

- Phone: 1-800-662-6983
- Email: support@soundcraft.com
- Web: [Soundcraft Support](#)

Universal Audio: Support for Realtime Rack Software and UAD Plug-Ins

Universal Audio provides free technical support for Realtime Rack software (including UAD Powered Plug-Ins) to registered product owners. Universal Audio does *not* provide technical support for configuration and operation of Soundcraft Vi Series consoles nor how to use Vi consoles with Realtime Rack.

Realtime Rack Software Knowledge Base

The latest technical information for Realtime Rack software is posted in the Universal Audio Knowledge Base. The Knowledge Base may contain updated, late-breaking information that is not available in other publications.

- help.uaudio.com

Contact Universal Audio Support

Support specialists are available to answer technical inquiries via email and telephone. To contact UA support, visit:

- help.uaudio.com

Soundcraft®
— Realtime Rack —



UNIVERSAL AUDIO

www.uaudio.com
www.soundcraft.com