

MIPRO®

User Guide

Portability · Simplicity · Flexibility

MA-101A / MA-101B

Personal Wireless Public Address System



MIPRO®
MICROPHONE PROFESSIONALS

MIPRO Electronics Co., Ltd

Headquarters : 814 Pei-Kang Road, Chiayi, 60096, Taiwan
Tel : +886.5.238.0809 Fax : +886.5.238.0803
www.mipro.com.tw mipro@mipro.com.tw



2 CE471B

All rights reserved. Do not copy or forward without prior approvals MIPRO.
Specifications and design subject to change without notice. MN 014/04

! IMPORTANT SAFETY INSTRUCTIONS !

1. Read these instructions.
2. Keep these instructions.
3. Heed all warnings.
4. Follow all instructions.
5. Do not use this apparatus near water.
6. Clean only with a dry cloth.
7. Do not block any ventilation openings. Install in accordance with the manufacturer's instructions.
8. Do not install near any heat sources such as radiators, heat registers, stoves, or other apparatus (including amplifiers) that produce heat.
9. Do not defeat the safety purpose of the polarised or ground plug: A polarised plug has two blades with one wider than the other. The wide blade is provided for your safety. When the provided plug does not fit into your outlet, consult an electrician for replacement of the obsolete outlet.
10. Protect the power cord from being walked on or pinched particularly at plug, convenience receptacles, and the point where they exit from the apparatus.
11. Only use attachments/accessories specified by the manufacturer.
12. Use only with a cart, stand, tripod, bracket, or table specified by the manufacturer, or sold with the apparatus. When a cart is used, use caution when moving the cart/apparatus combination to avoid injury from tip-over.
13. Unplug this apparatus during lightning storms or when unused for long periods of time.
14. Refer all servicing to qualified service personnel. Servicing is required when the apparatus has been damaged in any way, such as power-supply cord or plug is damaged, liquid has been spilled or objects have fallen into the apparatus, the apparatus has been exposed to rain or moisture, does not operate normally, or has been dropped.
15. To reduce the risk of fire or electric shock, do not expose this apparatus to rain or moisture.
16. Apparatus should not be exposed to dripping or splashing and no objects filled with liquids, should be placed on the apparatus.
17. Use only with the battery which specified by manufacturer.
18. The power supply cord set is to be the main disconnected device.



WARNING

1. **FOR OUTDOOR USE:**
To reduce the risk of fire or electric shock, do not expose this apparatus to rain or moisture.
2. **UNDER WET LOCATION:**
Apparatus should not be exposed to dripping or splashing and no objects filled with liquids, such as vases should be placed on the apparatus.
3. **SERVICE INSTRUCTIONS:**
CAUTION - These servicing instructions are for use by qualified service personnel only. To reduce the risk of electric shock, do not perform any servicing other than that contained in the operating instructions unless you are qualified to do so.

	This symbol indicates that dangerous voltage constituting a risk of electric shock is present within this unit.
	This symbol indicates that there are important operating and maintenance instructions in the literature accompanying this unit.

FC & IC - ID

THIS DEVICE COMPLIES WITH PART15 OF THE FCC RULES AND RSS-123 ISSUE2 OF CANADA. OPERATION IS SUBJECT TO THE FOLLOWING TWO CONDITIONS:

- (1) This device may not cause interference.
- (2) This device must accept any interference, including interference that may cause undesired operation of the device. This equipment complies with FCC RF radiation exposure limits set forth for an uncontrolled environment.

"This product can only be used at the area that the altitude is lower than 2000m for safety purpose."

"This product can be used in non-tropical locations only for safety purpose."

Disposal Dispose of any unusable devices or batteries responsibly and in accordance with any applicable regulations.



2005-08-13

Disposing of used batteries with domestic waste is to be avoided!

Batteries / NiCad cells often contain heavy metals such as cadmium(Cd), mercury(Hg) and lead(Pb) that makes them unsuitable for disposal with domestic waste. You may return spent batteries/ accumulators free of charge to recycling centres or anywhere else batteries/accumulators are sold.

By doing so, you contribute to the conservation of our environment!

Personal Wireless Public Address System

- 1 Accessories
- 2 Part Names and Functions
- 4 Set-up Receiver and Transmitter Frequencies
- 5 Connection to External Audio Sources
- 6 Operating Instructions
- 8 Replacing the MA-101A/MA-101B Rechargeable Battery
- 10 Charging the Battery
- 11 Troubleshooting-Portable Public Address
- 12 Troubleshooting-Wireless Microphone Systems
- 15 Rechargeable Battery Guide
- 16 Optional MA-101A/MA-101B Accessories
- 17 MIPRO Wireless Microphone Systems for MA-101A/MA-101B

ACCESSORIES

The following accessories are included:

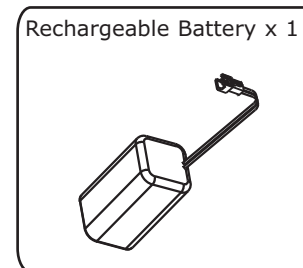
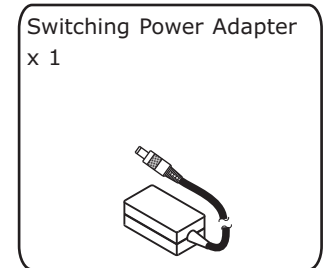
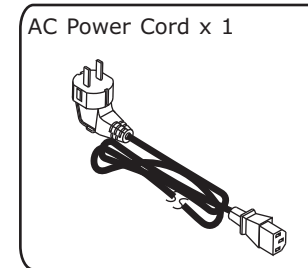
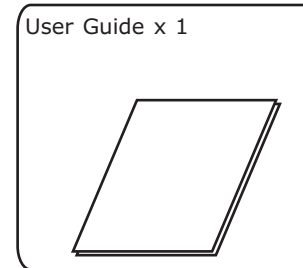

ACCESSORIES

The following accessories are not included:



PART NAMES AND FUNCTIONS

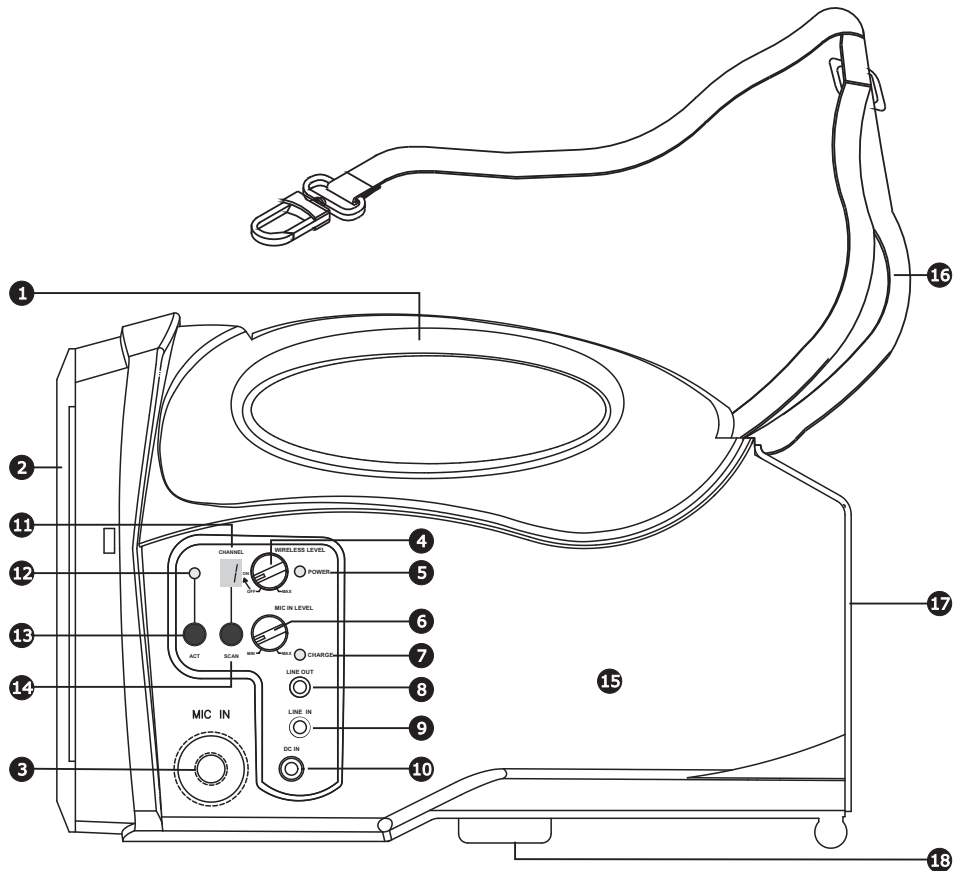

- 1 Fixed Carry Handle:** For convenient carrying by hand.
- 2 Speaker:** 5-inch full-range loudspeaker.
- 3 Microphone Input Jack:** Accepts a 6.3mm (1/4") wired dynamic microphone. (Microphone Level)
- 4 POWER Switch/Wireless Mic Volume Control:** Turn clockwise past the click for power-on and volume control for the wireless microphone.
- 5 POWER Indicator:** Red light illuminates when power is turned on to denote normal power status. Green light indicates a RF link (it is receiving signal from the wireless microphone).
- 6 Microphone Volume Control:** Volume control for the wired microphone.

- 7 BATTERY CHARGING Indicator:**
 - Red light indicates the battery is weak and needs charging. Full charge takes a minimum 4 hours.
 - Green blinking light indicates charging is in progress.
 - Solid green light indicates the battery is fully charged.

Note: This system is equipped with an auto cut-off charger. When the battery is weak (red light), power will cut off automatically to avoid any damage that could be caused by a power over-drain.
- 8 Line Output Jack:** Allows you to send audio signal (AF) to an external amplifier.
- 9 Auxiliary Input Jack:** Accepts external audio line inputs, such as CD, MP3, cassette, DVD/VCD, computer sound card, or other audio signals. 3.5mm (1/8") jack.
- 10 DC Power Input Jack:** Plug into DC charger (supplied) for battery charging. The inner conductor is positive and should be connected to 19V DC 10%, +2.5A.
- 11 CHANNEL Screen:** Displays current channel.
- 12 ACT Infrared (IR) Port:** Transmits IR signal to transmitter to synchronize frequencies.
- 13 ACT Sync Button:** Press to synchronize the receiver and transmitter frequencies.
- 14 SCAN Button:** Press for an interference-free receiver frequency.
- 15 Enclosure:** Houses all electronic components.
- 16 Shoulder Strap:** Carried via the shoulder strap.
- 17 Battery Compartment:** Houses the rechargeable battery and stores shoulder strap, microphone and extra mic battery.
- 18 Microphone Stand Mount:** For convenient mounting on a standard microphone stand.

SET-UP RECEIVER AND TRANSMITTER FREQUENCIES

AUTOMATIC "RECEIVER" FREQUENCY SELECTION

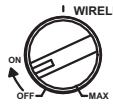
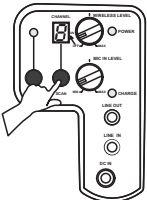
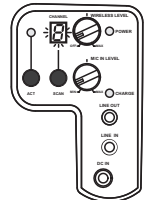
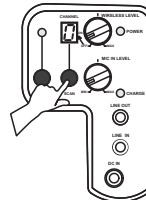
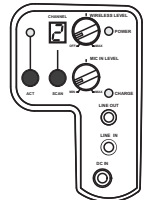
1. Turn "ON" the Power Switch. 
2. The Power Indicator red light is lit. 
3. Press & hold "SCAN" button for 1 second 
4. Existing channel blinks 
5. Press & release "SCAN" button 
6. New interference-free channel appears

AUTOMATIC "TRANSMITTER" SYNC

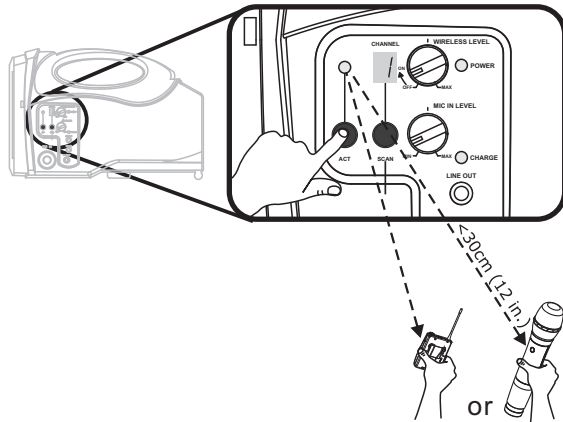

1. **POWER** on transmitter (ensure fresh batteries are properly installed with the correct polarity). Replace transmitter battery when LED glows red during powered-on. (glows red = low battery)
2. Locate and bring an ACT transmitter ***infrared (IR) port** within **30cm (12-inch)** of receiver's ACT button.
3. Press and release "**ACT**" button to synchronize transmitter and receiver frequencies.
4. When the frequencies are synchronized successfully the Power Indicator light will turn from red to green to indicate it is receiving RF signal from the transmitter.

CONNECTION TO EXTERNAL AUDIO SOURCES

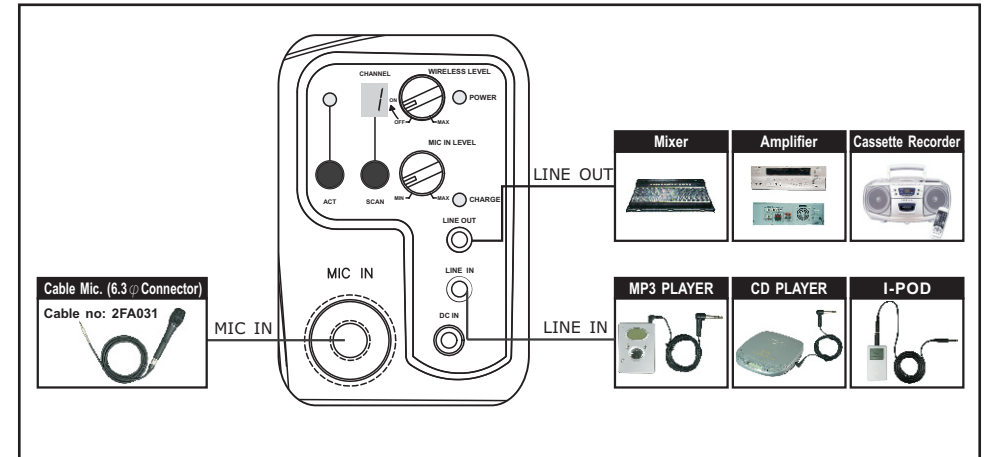

LINE-INPUT (AUXILIARY)

- The 3.5mm (1/8") auxiliary input jack accepts an external MP3, DVD, cassette or CD players, music instruments or audio line output from another device like a computer sound card.
- Ascertain volumes of both MP3, DVD, cassette or CD players and Power Switch/Wireless Mic Volume Control are turned down before plugging into the MA-101A /MA-101B auxiliary input jack.
- Adjust both volumes clockwise for the desired sound levels.

LINE-OUTPUT

- The 3.5mm (1/8") line output provides audio signal to an external equipment to record a presentation or singing.
- Use Power Switch/Wireless Mic Volume Control for volume control.

OPERATING INSTRUCTIONS

Personal Wireless PA System

- Turn on Power Switch / Volume Control ④ . Red light ⑤ should illuminate.
- Turn on wireless transmitter. Green light ⑤ should illuminate.
- Adjust volume level ④ clockwise to desired loudness.
- One wireless microphone can simultaneously transmit to multiple MA-101A/MA-101B units receiving on the same frequency. However, multiple wireless microphones of the same frequency cannot transmit to an MA-101A/MA-101B receiver on that same frequency. For example, if you have both a hand-held wireless microphone and a body-pack transmitter on the same frequency, be sure to switch off one of the two to avoid severe interference between them!

Battery Charging Procedures:

- Please make sure the built-in rechargeable batteries are fully charged before and after use. The battery itself will gradually self-discharge over a long period of time. Therefore, if the system will not be used for a long period of time, please make sure the batteries are fully charged before storing them properly. The Company warranty DOES NOT apply to over-discharged batteries; hence, please ensure the batteries are recharged every 3 months.
- Simply plug the connector of the supplied DC adapter to the DC 19V Power Input Jack and plug the other end into any available AC socket.
- Charging begins immediately, and will be indicated by a flashing green LED. If the green LED is not flashing, it may be due to excessive power over-drain and it may take longer for the green LED to flash. This is normal and not faulty. If, after a while, there is still no flashing green LED, the rechargeable battery may be faulty.
- If a battery replacement is needed, open the battery compartment and exchange the faulty battery for a new one. Be sure to insert the battery with the right polarity connection.
- The battery is an expendable item. Under normal operation, MIPRO offers a one-year limited warranty.
- If you experience a short operating time after the batteries are fully charged, it is often an indication of aging batteries. Therefore, the rechargeable battery should be replaced as soon as possible at your earliest convenience.

Auxiliary In

- Connect a line-level source, such as portable cassette/CD/MP3 player into the Aux input jack ⑨ .
- Turn on the PA system ④ and adjust volume as desired.

Installation

- Hand Carrying: Remove the shoulder belt ⑩ and store in the Battery Compartment ⑪ directly above the battery. Use the Fixed Handle for transport.
- Shoulder Carrying: Remove the shoulder belt ⑩ from the Battery Compartment ⑪ and hook the connector around the rod on top of the unit, between the Fixed Handle and the Speaker.
- Mic Stand Mounting: The MA-101A/MA-101B will fit directly on top of a mic stand using the threaded mount ⑬ with no additional hardware. Simply align the hole with the protruding end of the mic stand and thread it on the stand.

Wired Microphone Instructions

- Turn on Power Switch / Volume Control ④ . Red light ⑤ should illuminate.
- Plug a wired microphone into the Mic In Jack ③ . Turn on the Wired Microphone Volume Control ⑥ .
- Turn clockwise for desired loudness ⑥ .
- The MA-101A/MA-101B allows simultaneous usage of both wired and wireless microphones.

AF Output

- Allows the user to connect the MA-101A/MA-101B to an external amplifier with high power output. Connect to the Mic Input or Line Input on the amplifier. Use the Power Switch / Volume Control ④ to control the volume level.

REPLACING THE MA-101A/MA-101B RECHARGEABLE BATTERY

With proper care and charging, it is unlikely that it will be necessary to replace the battery for some time. However, there is an access panel provided for this purpose. If extended periods of use are required without time to recharge the battery, you may wish to have a second battery fully charged and ready to install and use once the existing one is drained. The battery is a standard 14.8V/2.6AH rechargeable lithium battery and is available from MIPRO.

BATTERY REPLACEMENT STEPS

- Press down on the two fasteners at the top of battery compartment. The compartment door will now swing down on its hinge.
- Remove the interior rear panel of the battery compartment by sliding it up. Use caution, as the battery may "spring" forward when you release this panel. Carefully remove the battery.

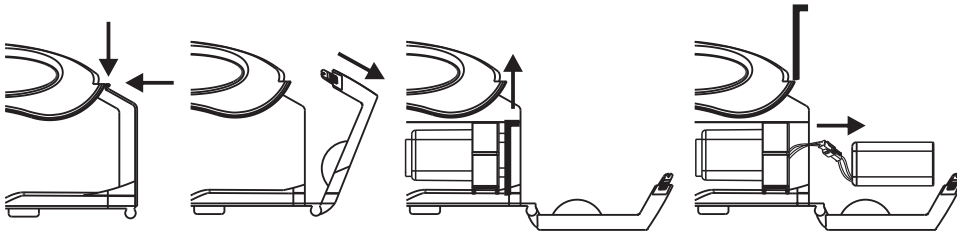

- Press two sides of the socket with cable connected to the unit and remove the plug with cable connected to the battery.

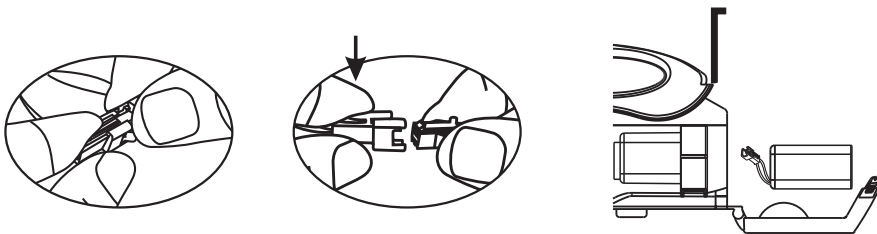

- Insert the plug with cable connected to the new battery into the socket with cable connected to the unit, keep the battery end with cable toward to the battery compartment and push the battery into the unit, well put the connecting cable into the groove in the bottom of the battery compartment.
- Press the battery into the unit, while sliding the rear panel back into space. This may require two hands.
- Close the battery compartment door. Lift up on the two fasteners until they "click" into place.

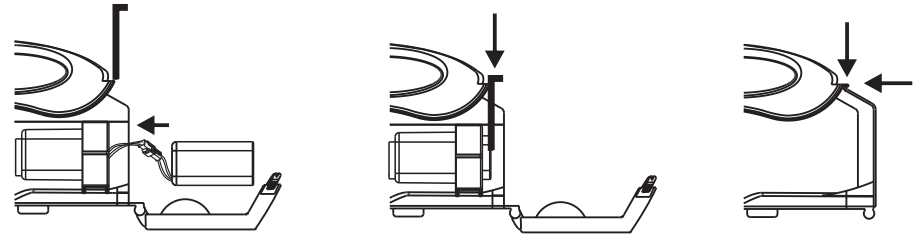

CHARGING THE BATTERY

- Plug the one end of the cord into the DC Power Input Jack and the end into an AC outlet.
- Blinking green light ⑦ = charging in progress
- Solid green light ⑦ = battery is fully charged
- Solid red light ⑦ = battery is weak and needs charging. Full charge takes a minimum 4 hours.

Note:

- Due to excessive battery power drain the green battery charge indicator may not start to blink immediately when plugged in. This is normal. After 5~10 minutes the indicator should begin to blink.
- If the battery charge indicator fails to light, it maybe due to a faulty battery. Replace with a new battery.
This system is equipped with an auto cut-off charger. When the battery is weak (red light), power will cut off automatically to avoid any damage that could be caused by a power over-drain.

HELPFUL OPERATING TIPS

1. We recommend placing sound system between the target audience and the presenter, facing the audience and raised above their heads using a speaker stand or table. This set-up helps prevent the annoying feedback by keeping wireless & wired microphone users behind the sound system. The internal power supply rechargeable, lead-acid batteries should be kept fully charged. Always charge the system after use.
2. If you operate the system from an external AC power supply, then the internal battery supply will charge at the same time, a very useful feature.
3. If the LED indicator on the power switch flashes after first turning the unit ON or it starts to do so during use on the internal DC supply (low battery warning), you should switch to the AC power supply by using the AC power cord.
4. Before turning power ON to the unit, please set all volume controls to their minimum level. This prevents any loud 'thumps' at power on. Adjust the volume controls afterward.
5. NEVER place any microphone in front or close in front of the speaker otherwise damaging feedback (both to the operators ears and the system) could occur.

TROUBLESHOOTING-PORTABLE PUBLIC ADDRESS

PROBLEM	POSSIBLE CAUSE	SOLUTION
No Sound or Faint Sound From Speaker	Volume turned down	Adjust volume
	Power switch is turned off	Turn power switch on
Power Indicator Not On	Power switch is turned off	Turn power switch on
	Rechargeable Battery is discharged	Plug into AC outlet to recharge
	Rechargeable Battery is "dead"	Replace battery and plug into AC outlet to recharge
Distorted Sound From Speaker	Volume set too high	Reduce volume
	Excessive wind noise or breath "pops"	Use windscreen on wireless & wired microphones.
	Input signal too strong	Adjust input signals
Excessive Feedback	Microphone too close or directly in front of the speaker	Move microphone away from the speaker
	Volume set too high	Reduce volume
	Microphone too far from sound source (requiring the volume to be turned up to compensate)	Speak closer to the microphone or move microphone closer to sound source
	Batteries level is low	Plug into AC outlet to recharge
Weak, Distorted Sound. Power Indicator Flickers	Batteries level is low	Plug into AC outlet to recharge
Excessive Hum or Noise	Input Cable not shielded	Use shielded cable
Shortened Battery Life	Old or overused battery	Recharge or replace battery
	Battery is not charged for over 3~4 months	Recharge or replace battery
Battery CHARGE Indicator Not Flickering when plugged into AC Outlet	Rechargeable Battery is "dead"	Replace battery
	Battery is not charged for over 3~4 months	Recharge or replace battery
	Battery is fully charged (CHARGE indicator is lit)	N/A

TROUBLESHOOTING-WIRELESS MICROPHONE SYSTEMS

PROBLEM	POSSIBLE CAUSE	SOLUTION
No Sound From Speaker	Master or receiver volume turned down	Adjust volumes
	Transmitter or receiver switch is turned off	Turn transmitter or receiver switch on
	Receiver and transmitter have different frequencies	See "Set-up Receiver & Transmitter Frequencies" section
	Transmitter battery is low or no battery inside	Replace or insert new battery
	Headset or lavalier microphone is not plugged into bodypack transmitter	Plug headset or lavalier microphone into bodypack transmitter
Distortion or Unwanted Noise Bursts	Interference	Remove nearby sources of RF interference (computers, amplifiers, karaoke machines, digital effects, CD players, etc)
	Noise Indicator is lit	Adjust "Sensitivity" on receiver.
		If problem persists, change Receiver & Transmitter frequencies.
		See "Set-up Receiver & Transmitter Frequencies" section
Sound Dropouts	Out of operating range	Move transmitter closer to receiver
	Obstructions between the receiver and transmitter	Remove obstructions or reposition
		Line-of-sight between receiver & transmitter
	Weak Transmitter Battery	Replace Transmitter Battery
	Interference	Change Receiver & Transmitter frequencies
See "Set-up Receiver & Transmitter Frequencies" section		

FAQ - PORTABLE PA

Q: How to adjust for optimal sound volume?

A: If the portable system has both Master & Microphone volumes, we recommend turning the Master volume to about 3pm (clockwise) first and about 1~2pm (clockwise) for Microphone or other volumes.

Q: How to prevent and minimize the annoying feedback?

A1: Do not stand directly in front of the speakers; keep mics away from speakers.

A2: Avoid pointing microphone towards the speakers.

A3: The microphones should be behind the speakers wherever possible.

A4: Locate the portable PA between the crowd and the presenters and facing the crowd.

A5: Turn down the sound level coming out of the portable PA / speakers if necessary.

A6: Place the speakers above the head of the crowd.

Q: What if I need more power to cover a larger crowd?

A: Two or more portables can be used with one wireless microphone transmitter. Ascertain that the receiver frequency in each portable coincides with the wireless microphone.

Q: Can I play music through the systems?

A: Yes. All MIPRO portables have auxiliary inputs (3.5mm min-jack, RCA or 1/4" phone), which will accept input from an external iPod, MP3, CD, cassette, VCR, DVD players. As well, modular CD players can be inserted into most models.

FAQ - RECHARGEABLE BATTERY

Q: How to Charge the Battery?

A: Simply plug into a power outlet using the included power cable and adapter. "Flashing" LED indicates it is charging. The main power switch can be on or off position during charging. Microphones or music can be used during charging & power is on.

Q: How to Spot System Low Battery?

A: When Power LED is lit (MA-705 & MA-707) or Charge LED is lit (MA-101, MA-101a, MA-101A & MA-101B) or one indicator remaining in battery meter (MA-100, MA-202, MA-303, MA-505, MA-708, MA-808). Plug into a power outlet to re-charge ASAP.

Q: Average Life Span of Sealed Lead-Acid Rechargeable Battery?

A: The batteries should have a life of approx. 2 years if used and maintained properly. Battery life is determined by temperature, depth and rate of discharge, and the number of charges and discharges (called cycles).

Q: When to Replace the Battery?

A1: Power LED indicator is not "lit" when power on. (No battery voltage).

A2: LED indicator or meter is not "flashing" when plugged-in.

A3: Getting 1~2 hours operating time per charge.

A4: When battery has been used extensively for 2~3 years or more.

RECHARGEABLE BATTERY GUIDE

Tips - To Prolong the Life of Rechargeable Batteries

- Always charge the batteries before first and after use.
- Always store portable system with batteries in a fully charged condition.
- Always power off the portable system and transmitter/mic when NOT in use
- It is OK to leave the system plugged into a power outlet when not being used for a long time. The built-in automatic protection circuitry will auto shut-off when fully charged. It will not harm the system or the battery.
- Fully charge the system at least once every 3 months. Battery may not charge if not charged for a prolonged periods of time.
- Store in dry, cool place away from heat. Elevated temperature reduces longevity.

CAUTION: DO NOT recharge other types of batteries and connect a battery's negative terminal to another batteries positive terminal. An explosion and/or a fire could occur as a result. Use only rechargeable Lithium battery.

OPTIONAL MA-101A/MA-101B ACCESSORIES

MB-25: 14.8V/2.6AH Rechargeable Battery

Rechargeable Lithium battery

MS-30: Microphone Tripod Stand

Adjustable stand for portable PA system

SC-10: Carrying Case

Carrying case and storage. Storage for wireless & wired microphones cable, battery

MM-107: Handheld Wired Microphone

MIPRO's Hypercardioid Dynamic Microphone with cable.

ASP-10: Aerobic Sports Pouch

Sweat-resistant transmitter pouch belts for MIPRO bodypack transmitters.

MIPRO WIRELESS MICROPHONE SYSTEMS FOR MA-101A/MA-101B

ACT-30H/ACT-32H - Handheld Transmitter Microphone (AA x 2: not included)

ACT-30T/ACT-32T - Body Pack Transmitter (AA x 2: not included)
(microphone not included - see below)

MU-53HN (black) ; MU-53HNS (beige) Premium Headworn Microphone
Uni-directional, Premium 10mm, Ideal for speech and singing. Works with all MIPRO
bodypack transmitters

MU-55HN (black) ; MU-55HNS (beige) Subminiature Headworn Microphone
Omni-directional, 4.5mm, Sweat-proof, Ideal for speech. Works with all MIPRO
bodypack transmitters

MU-13/MU-13d (beige) Premium Single-sided Earworn Microphone
Omni-directional, ultra small & lightweight 3mm, Ideal for speech. Works with all MIPRO
bodypack transmitters

MU-53L (black) ; MU-53LS (beige) Premium Lavalier Microphone
Uni-directional, 10mm, High-gain-before-feedback, warm, clear sound. Works with all
MIPRO bodypack transmitters

MU-55L (black) ; MU-55LS (beige) Subminiature Lavalier Microphone
Omni-directional, 4.5mm, Low visibility, Works with all MIPRO bodypack transmitters

Note:

Specifications and design subject to change without notice.