

# ULT-series

Loudspeakers

Owner's Manual

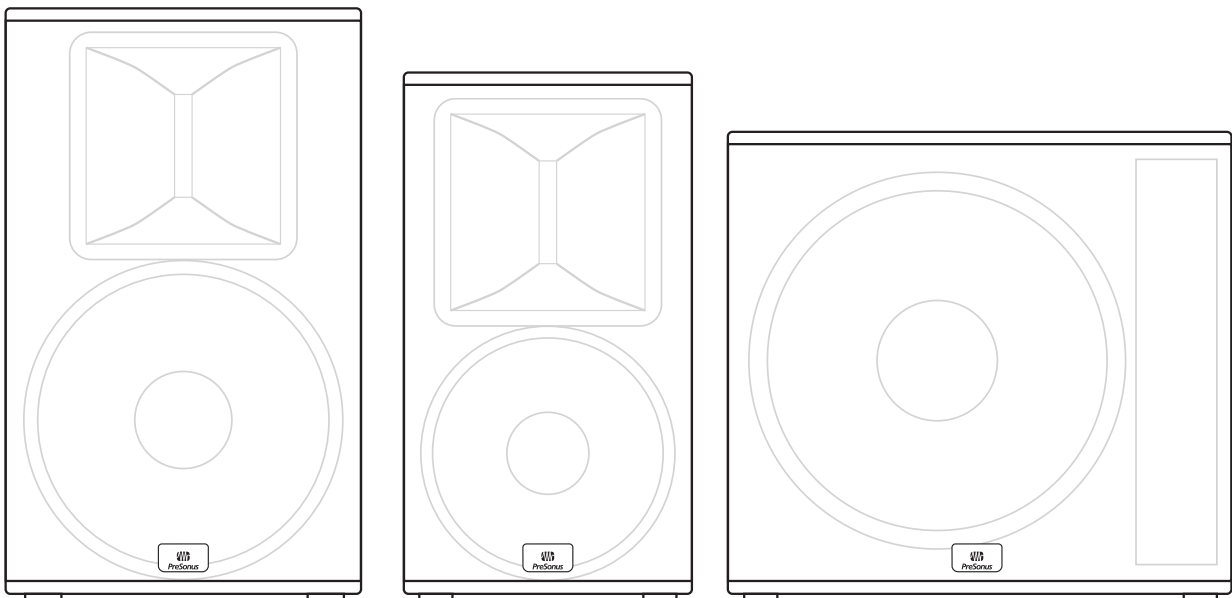

English

Español

Deutsch

Français



# Table of Contents

## **1 Overview — 1**

- 1.1 Introduction — 1
- 1.2 About This Manual — 1
- 1.3 Summary of ULT-Series Loudspeaker Features — 2
- 1.4 What is in the Box — 3

## **2 Getting Started — 4**

- 2.1 Level Setting Procedure (Full-Range) — 4
- 2.2 Level Setting Procedure (ULT18) — 7

## **3 Hookup — 11**

- 3.1 Rear-Panel Connections and Controls — 11
- 3.2 Onboard Performance Monitoring — 13
- 3.3 Power — 13
- 3.4 Hookup diagrams — 14

## **4 Loudspeaker Placement and System Configuration — 15**

- 4.1 Recognizing Problem Rooms — 15
- 4.2 System configuration suggestions — 17
- 4.3 Rigging and Safety — 21

## **5 Technical Information — 24**

- 5.1 Specifications — 24
- 5.2 Optional Accessories — 25

## **6 Troubleshooting and Warranty — 26**

- 6.1 Support and Troubleshooting — 26
- 6.2 Warranty — 27



## 1 Overview

### 1.1 Introduction

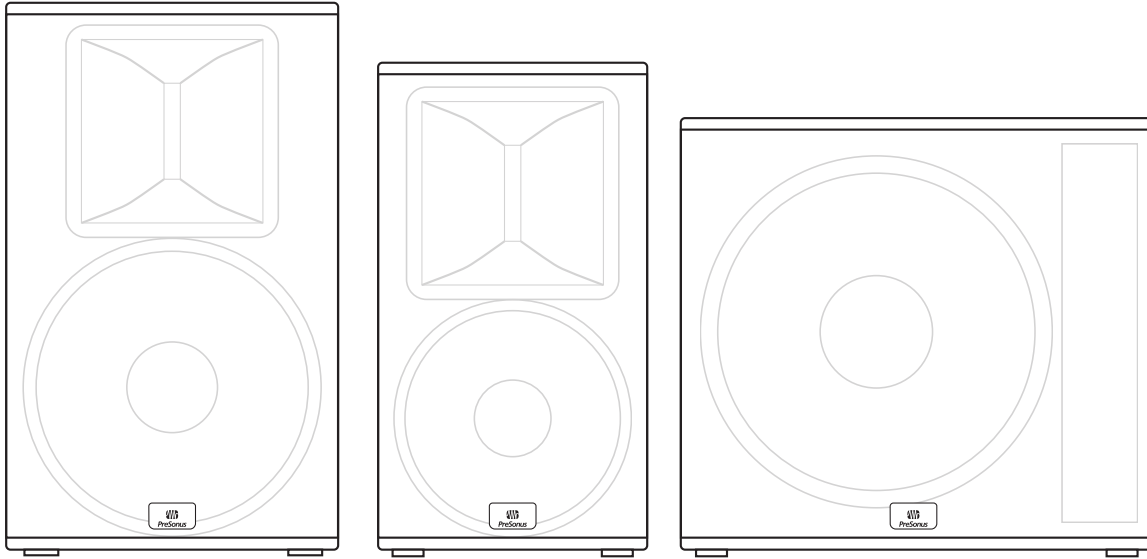

**Thank you** for purchasing a PreSonus® ULT-series Active Loudspeaker. PreSonus Audio Electronics has designed ULT-series Loudspeakers utilizing high-grade components to ensure optimum performance throughout the life of your PA system. The ULT-series loudspeakers are active PA speaker systems that provide the widest horizontal dispersion in their class, thanks to the custom Pivot X110 horn. Compact and lightweight, they provide a powerful, professional sound that makes them an ideal solution for mobile and install solutions alike.

We encourage you to contact us with questions or comments regarding this product. PreSonus Audio Electronics is committed to constant product improvement, and we value your suggestions highly. We believe the best way to achieve our goal of constant product improvement is by listening to the real experts: our valued customers. We appreciate the support you have shown us through the purchase of this product.

For technical support, please see Section 6.1: Troubleshooting.

### 1.2 About This Manual

This manual covers hardware features and functions for both full-range ULT-series loudspeakers (ULT12 and ULT15) as well as the companion ULT18 subwoofer. We suggest that you use the manual to familiarize yourself with the features, applications, and connection procedures for your ULT-series Loudspeakers before trying to set up and operate them.

Except for Low Frequency Driver configuration and some technical specifications (such as weight, frequency response, and maximum SPL), the features and functions of both full-range models are the same. In many respects, the functions of the ULT18 are also the same. Whenever possible these features and functions will be described for the entire line. Unless preceded by “full-range”, the term “loudspeaker” will refer to both full-range models and the subwoofer.

Throughout this manual you will find Power User Tips highlighting unique aspects of your ULT-series loudspeaker, as well as explanations of various audio terms. In addition, you will find an assortment of tutorials that cover the basics of room acoustics and speaker placement.

Thank you, once again, for buying our product. We are confident that you will enjoy your ULT-series loudspeakers!

## 1.3 Summary of ULT-Series Loudspeaker Features

### 1.3.1 Full-range Models (ULT12 and ULT15)

- 12" / 15" Woofer with 2.5" Voice Coil
- 1.75" diaphragm compression driver
- Worx designed waveguide Pivot X110 Horn for precise coverage
- Ultrawide 110° horizontal dispersion
- Tight 50° vertical dispersion for farther throw
- 3 presets plus high pass filter
- Maximum SPL 135 / 136 dB peak
- 55 Hz to 18 kHz / 52 Hz to 18 kHz frequency response
- Multi-angle enclosure for mains or monitor wedge application
- 1300-watt Class D power (150 x 500W continuous)
- Onboard mixer with two combo XLR and ¼" inputs; direct line input channel output; and single summed balanced output
- Defeatable front-panel LED
- Rugged, texture-painted birch enclosures
- XMAX Preamp
- Rotatable horn for horizontal mains use
- Tour-grade 16 gauge steel grilles
- Comfortable ergonomic handles
- 35 mm pole sockets with 6° downward tilt
- M10 rigging points for suspended installation
- Locking IEC connection

### 1.3.2 ULT18 Subwoofer

- 18" Woofer with 4" Voice Coil
- 7mm driver travel before over-excursion
- Extended Bass preset
- Polarity Invert
- Onboard fully Variable Low Pass filter lets you dial in upper frequency limit
- Maximum SPL 135 dB peak
- 35 Hz to 150 Hz (variable) frequency response
- 2000-watt Class D power (2 x 500 W continuous)
- Stereo Combo XLR and ¼" inputs with direct outputs
- Mono Mode sums both inputs to both outputs
- Defeatable front-panel LED
- Rugged, texture-painted birch enclosures
- Tour-grade 16 gauge steel grilles
- Comfortable ergonomic handles
- Locking IEC connection

## 1.4 What is in the Box

In addition to this manual, your ULT package contains the following:

- (1) ULT12, ULT15, or ULT18 Loudspeaker

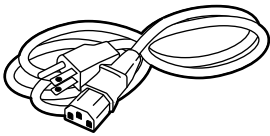
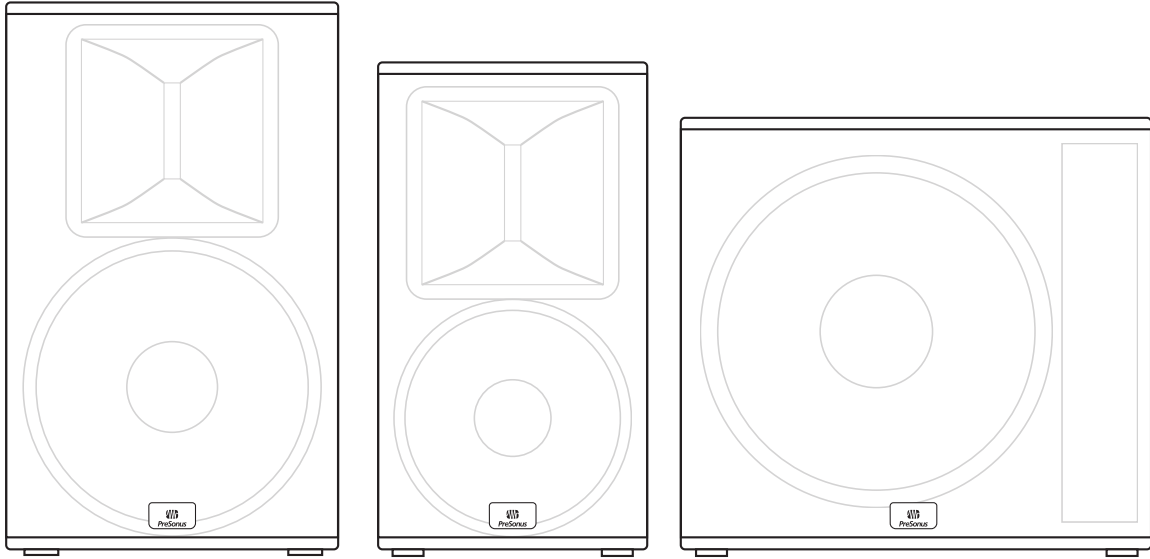

- (1) Locking IEC power cable

## 2 Getting Started

Before you begin, here are a few general rules of thumb:

- Always make sure your loudspeakers are powered off when making connections.
- Do not allow your inputs to clip. Watch the Clip LED on the back of your loudspeaker. When this LED illuminates, it indicates that the analog-to-digital converters are in danger of being overdriven. Overdriving the converters will cause digital distortion, which sounds terrible.
- Your full-range loudspeaker provides attenuation control only for the speaker and line levels. If you are not getting adequate volume with these controls turned all the way up (0 dB), make sure that your mixer is properly gain-staged and that you are using enough loudspeakers for your application.

Your PA and studio equipment should be powered on in the following order:

1. Sound sources (keyboards, direct boxes, microphones, etc.) connected to your mixer
2. Mixer
3. ULT-series Loudspeakers

When it's time to power down, your system should be turned off in the reverse order.

Now that you know what not to do, let's get some audio going! The following level-setting tutorials cover best practices that can be applied to nearly every application. The first tutorial covers level setting for the full-range models only; the second tutorial describes proper level setting for a system that includes one ULT18 subwoofer and two full-range ULT-series loudspeakers.

### 2.1 Level Setting Procedure (Full-Range)

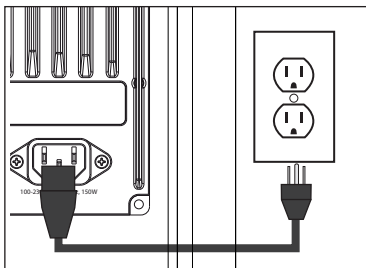

1. With the power switch in the Off position, connect the locking IEC plug to the IEC socket connection on the back of the loudspeaker and plug it into a grounded AC outlet or surge protector.

**⚠ WARNING:** While a locking IEC cable is ideal for permanent installation, be careful that this cable cannot be tripped over in ground-stacked applications, as this is a toppling risk.

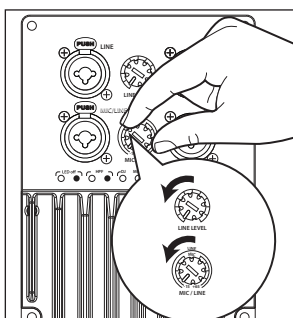

2. Turn the level knobs fully counterclockwise, to the lowest position.



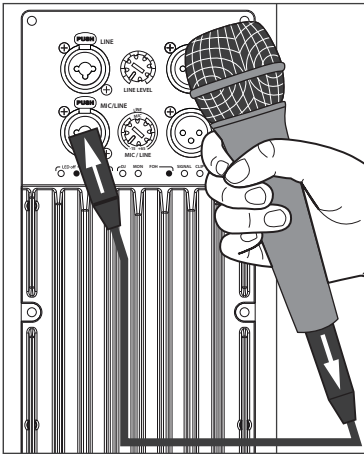

3. If you're using the ULT full-range loudspeaker as a mixer, connect a microphone to the Mic input with a standard XLR cable.

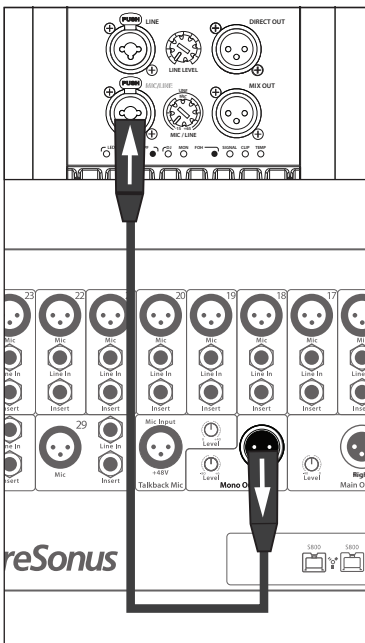

4. Connect your line-level source (such as a PreSonus StudioLive digital mixer) to the Line input. The Line input is a combo connection that accepts a balanced 1/4" TRS or XLR cable.

**Power User Tip:** If you are running a stereo system, connect the Left output of your mixer to the Left loudspeaker's line input, and the Right output to the Right loudspeaker's line input.

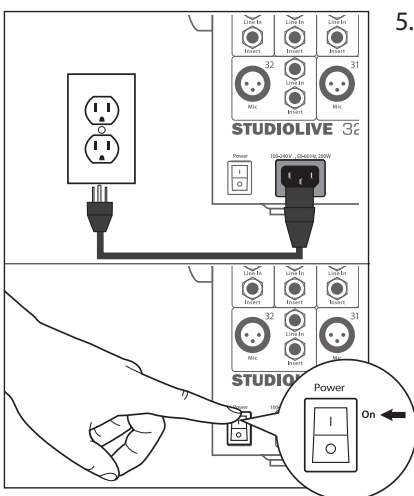

5. Power on your line-level source.

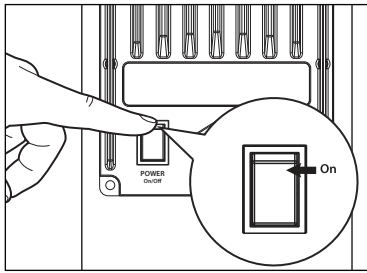

6. Power on your ULT-series loudspeaker.



7. While speaking into the microphone, use the Mic level knob to adjust the microphone level. Be sure that you are not standing directly in front of the loudspeaker while doing this, as doing so could result in feedback. If you are not using the Mic input, it is recommended that you leave this knob in the fully counter-clockwise position so as not to introduce noise into your signal path.

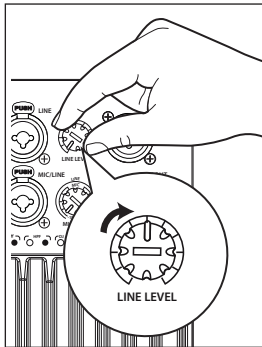

8. With audio playing through your line-level source, turn the Line level knob until you have achieved a comfortable listening volume. If you are not using the Line input, it is recommended that you leave this knob in the fully counterclockwise position so as not to introduce noise into your signal path.

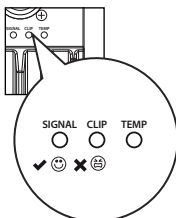

9. Both the Microphone and Line inputs should be set so that the green Signal LED is illuminated most of the time, but the red Clip LED illuminates only with the highest transient peaks or not at all.

10. If you are using the input mixer of one loudspeaker to connect a microphone and a line-level source, or if you are running a mono system, connect the Mix Out from the loudspeaker to which your sources are connected to the line input of the second loudspeaker and repeat steps 1-9.

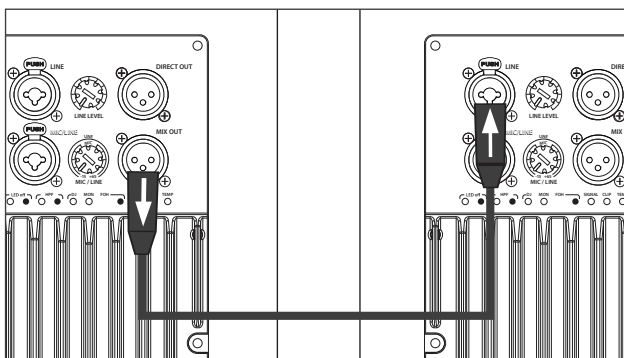

## 2.2 Level Setting Procedure (ULT18)

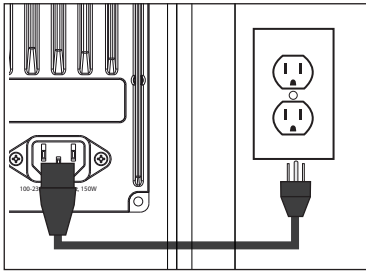

1. With the power switch in the Off position, connect the locking IEC plug to the IEC socket connection on the back of each loudspeaker and plug it into a grounded AC outlet or surge protector.

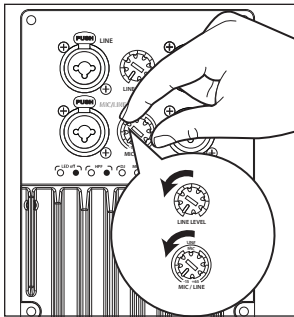

2. Turn the level knobs on your full-range loudspeakers fully counterclockwise to the lowest position.

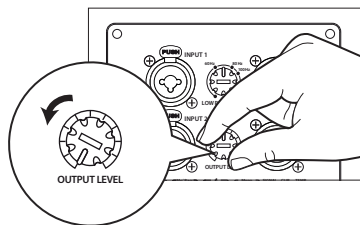

3. Turn the Output level knob on your ULT18 counterclockwise to the lowest position.

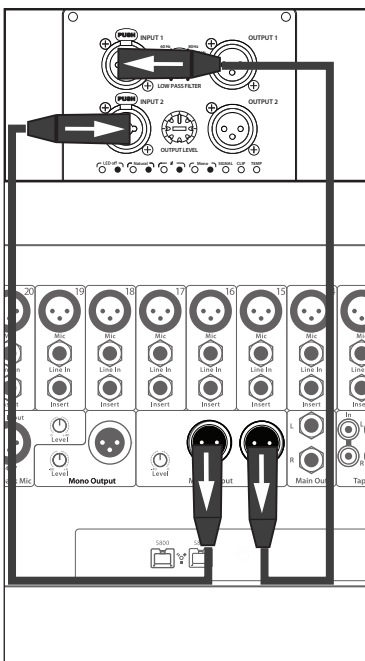

4. Connect your line-level source (e.g., a StudioLive mixer) to the Line inputs. This is a combo jack that accepts a balanced 1/4" TRS or XLR plug. If you are connecting a stereo source, the left side should be connected to Input 1 and the right side should be connected to Input 2.

5. Connect Outputs 1 and 2 of your ULT18 to the line inputs of the left and right full-range loudspeakers respectively.

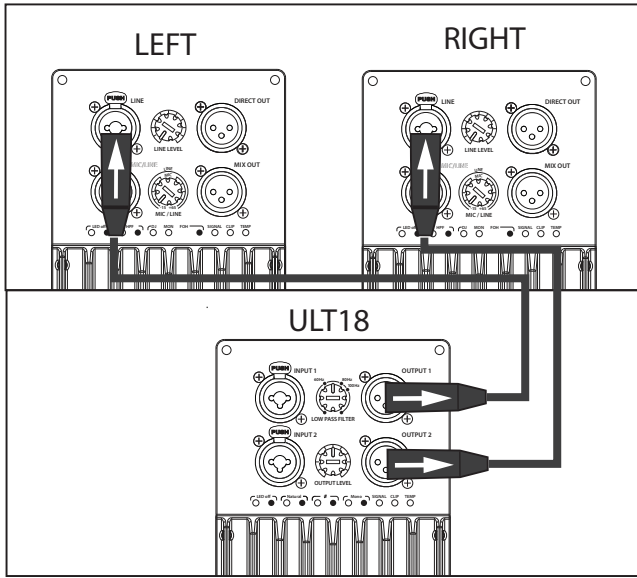

6. Power on your line-level source.

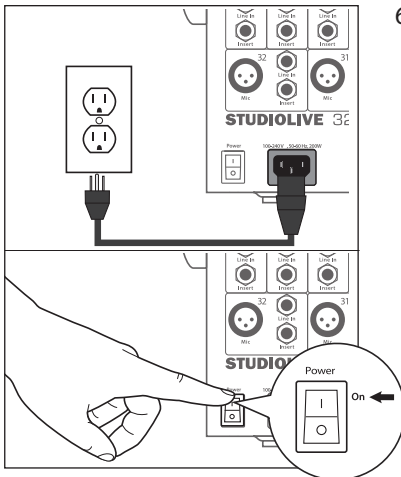

7. Power on your ULT18.

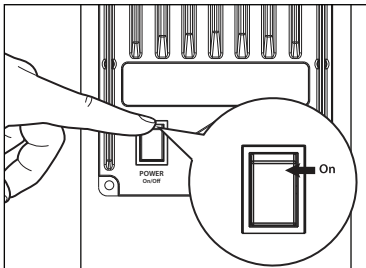

8. Power on your full-range loudspeakers.

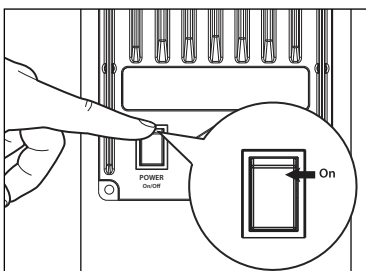

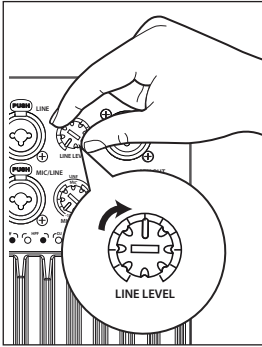

9. Turn the line level knob on your full-range loudspeakers to the 12 o'clock position.

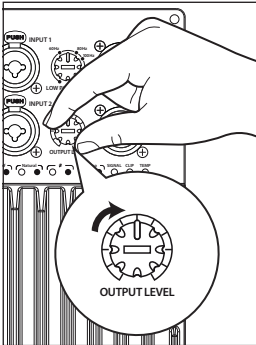

10. Turn the Output level knob on your ULT18 to the 12 o'clock position.

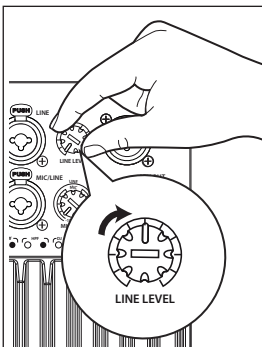

11. With audio playing through your line-level source, turn the line level knob on your full-range loudspeakers until you have achieved a comfortable listening volume.

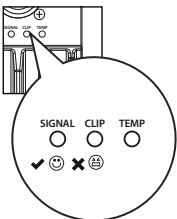

12. The line-level inputs should be set so that the green Signal LED is illuminated most of the time, but the red Clip LED illuminates only with the highest transient peaks or not at all. If your line-level source is clipping the inputs on your ULT18, you will need to turn down the source's output level.

If more high-frequency output level is required, turn the line-level knob clockwise on your full-range loudspeakers. In most cases, the level should be set the same on both loudspeakers.

Adjust the Output level control on your ULT18 to balance the low-frequency content level to taste.

### 2.2.1 Setting the Low Pass Filter

The ULT18 subwoofer is equipped with a variable low-pass filter allowing you to dial in the best crossover point for your system.

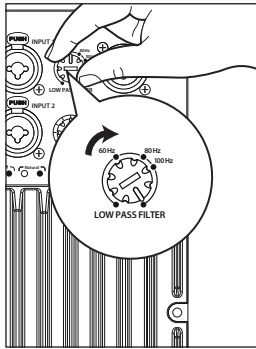

1. Set the low-pass filter fully clockwise. This will create an overlap between your ULT18 and your full-range system's frequency response
2. Play program music with a lot of bass in it through your full system.

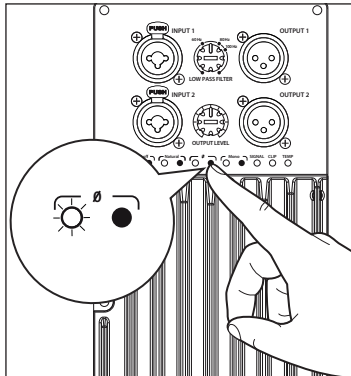

3. Experiment with the polarity switch on your ULT18 to see which position provides the best bass response. Leave the polarity switch in the position that provided the loudest bass response. This means that your subwoofer is in phase with your full-range speaker.

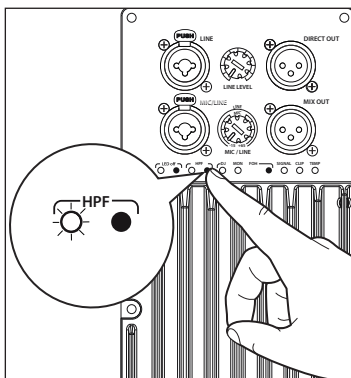

4. The ULT-series full-range loudspeakers provide a highpass filter centered at 100 Hz for bass management. Engage this filter to help create a more seamless crossover transition with your ULT18.

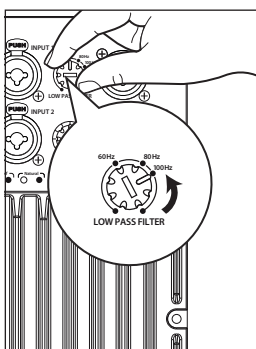

5. Set the lowpass filter on the ULT18 to 100 Hz. From this point, you can experiment with the lowpass filter setting until you find the one that provides the smoothest crossover transition while listening to your favorite music.

## 3 Hookup

### 3.1 Rear-Panel Connections and Controls

#### 3.1.1 Full-Range Models: ULT12 and ULT15

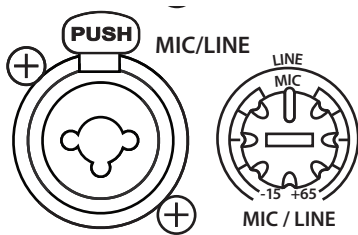

**Mic / Line Input and Level control.** Your ULT-series full-range loudspeaker is equipped with a PreSonus XMAX microphone preamplifier for use with most microphone types. The XMAX solid-state preamplifier has a Class A input buffer, followed by a dual-servo gain stage. This arrangement results in ultra-low noise and wide gain control, allowing you to boost signals without increasing unwanted background noise. The combo connection on this input also supports a line-level signal through the TRS connection.

Use the knob to the right of the Mic/Line connection to adjust the gain level of the Mic / Line input.

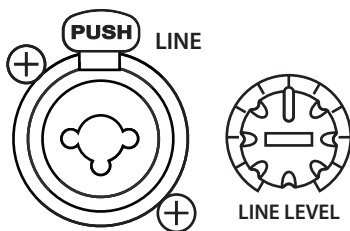

**Line Input and Level Control.** This is a balanced XLR / ¼" TRS combo connection for line-level input. Use the Line input to connect the loudspeaker to a StudioLive digital mixer or other mixing console, either directly or through the Line in/out connectors on a ULT18 subwoofer.

Use the knob to the right of this connection to adjust the gain level of the Line input.

**Power User Tip:** It is very important to properly adjust this control in order to minimize noise and avoid overload distortion. Follow the level-setting instructions in Section 2.1 before operating a channel.

**Note:** As with any amplifier or active loudspeaker, plugging in a microphone or a line-level input device, will create a momentary spike in the audio output of your ULT-series full-range loudspeaker. Because of this, it is highly recommended that you turn down the channel trim or power down your loudspeaker before changing connections. This simple step will add years to life of your audio equipment.

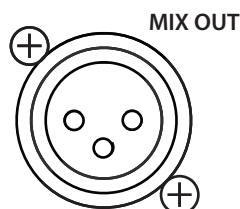

**Mix Out.** A balanced Mix output is provided on an XLR-M connector. The Mix Out connection is used to send signals connected to the inputs of your loudspeaker to other ULT-series loudspeakers. The Mix output signal is the same as the signal sent to the loudspeaker's internal amplifier, and it may be derived from the microphone input, the line input, or a mix of both. The Mix output will drive at least 100 feet of balanced cable, with no signal degradation, at maximum level.

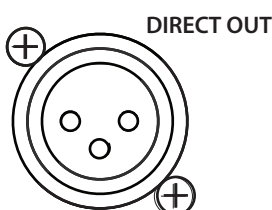

**Direct Out.** This is the Direct Out for the line input. Use this to connect to other ULT-series loudspeakers if the line level input is used only.



**LED Off.** This button turns the front panel LED off. When the front LED is off, the rear panel LED will illuminate and serve as your power indication.



**High Pass Filter.** This button enables/disables the 100 Hz High Pass Filter. When the LED is illuminated, the 100 Hz High Pass Filter is active. When active, frequency content below 100 Hz is removed. This low-frequency content may introduce destructive cancellations with the highest frequencies reproduced by a subwoofer. The filter may also be used to remove stand thumps, mic-handling noise, etc.



**Preset Controls.** Your ULT full-range speaker is equipped with three presets:

- **FOH.** This preset is optimized for live music performance. This mode is suitable for use with PreSonus StudioLive consoles and most other mixing consoles.
- **Mon.** Floor monitor mode sets dynamics and equalization for optimum results when the loudspeaker is used as a floor monitor.
- **DJ.** This preset is optimized for use with pre-recorded music, enhancing the highest and lowest frequencies for more high-fidelity performance.

### 3.1.2 ULT18 Subwoofer

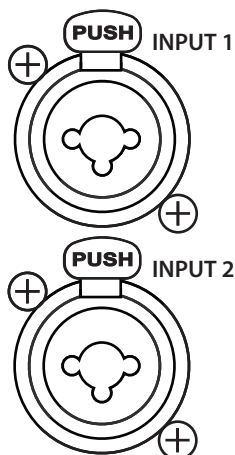

**Line Inputs.** The ULT18 features two line-level inputs. These balanced XLR / ¼" TRS combo connections are provided to connect your subwoofer to a StudioLive digital mixer or other mixing console.

**Power User Tip:** Two inputs are provided in order to accept a stereo signal from the output of the mixing console. Both channels should be connected, as the low-frequency content from both channels of a stereo signal is summed before the low-pass filter. However, if the mixing console output signal is mono only, or if you are sending low-frequency channels (bass, kick, keyboards, etc.) to a separate aux or subgroup output for the subwoofer only, either input may be used. If you are using two ULT18 subwoofers and running your system in stereo, connect the Left side to Input 1 of the left ULT18 and the Right side to Input 1 of the right ULT18.

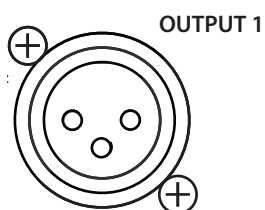

**Outputs.** Two line-level outputs (1 and 2) are provided to pass the stereo signal from the subwoofer to full-range loudspeakers. The outputs are parallel to Inputs 1 and 2, respectively. The line-level outputs will drive at least 100 feet of balanced cable with no signal degradation.

For more information on connecting multiple loudspeaker systems, see the hookup diagrams in Section 3.4.

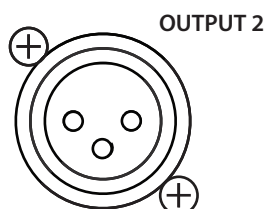

**Output Level.** The Output level knob determines the output level (volume) of the subwoofer power amplifier. It has no effect on the signal level from Outputs 1 and 2.

**Power User Tip:** A subwoofer can significantly change the frequency response of a full-range system. A 4-way system with a subwoofer will be 6 to 18 dB hotter below 80 to 100 Hz. Set the appropriate level for your subwoofer before adjusting your system EQ.

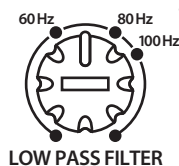

**Low Pass Filter.** This control determines the upper end of the frequency range reproduced by the ULT18. If you have enabled the highpass filter on your full-range loudspeaker, set the Low Pass Filter control to the same value. Otherwise set the Low Pass Filter control to the lowest frequency that your full-range loudspeakers can reliably reproduce.



**LED Off.** This button turns the front panel LED off. When the front LED is off, the rear panel LED will illuminate and serve as your power indication.





**Natural.** This changes the bass response of your ULT18 to provide less low-end extension and more punch.



**Polarity.** The Polarity button reverses the polarity of the summed input signal. The LED will illuminate to indicate that the polarity is reversed.

**Power User Tip:** Reversing the polarity can improve the system's response when low-frequency waveforms from the subwoofer are reinforced or cancelled by waveforms from another subwoofer or from the low-frequency drivers of the full-range loudspeakers. This is a complex interaction that also includes room acoustics, so setting is best done "by ear."



**Mono Switch.** The Mono switch sums Inputs 1 and 2 and patches the summed signal to Outputs 1 and 2. This feature is especially useful when running stereo full-range systems with multiple mono subwoofers.

### 3.2 Onboard Performance Monitoring

**Performance Monitoring.** These three LEDs display the performance status of the internal amplifier:

- **Signal.** Illuminates green when a signal is present at the input.
- **Clip.** Illuminates red when the input signal reaches 0 dBFS. At this level, the signal will exhibit signs of clipping (distortion), and the analog-to-digital (ADC) converter (and therefore the amp) will be clipping.
- **Thermal.** Illuminates red when the amplifier power supply or output stages exceed thermal limits. The amplifier will mute until the temperature drops below the thermal-limit threshold.

**Power User Tip:** Never run your input levels higher than the channel inputs can handle.

*If you overdrive the A/D converters, it will cause digital distortion (digital clipping), which sounds terrible.*

### 3.3 Power

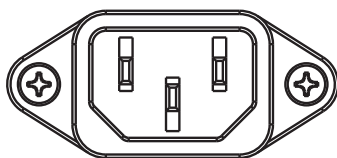

100-230V~, 50-60 Hz, 150W

**AC Line Connection.** ULT-series loudspeakers have a universal power supply that accepts AC power input between 100 and 250 VAC at 50/60 Hz. Each loudspeaker is supplied with an IEC cord appropriate for the country of sale.



**WARNING:** Do not remove the center grounding prong or use a ground-lift adapter, as this could result in electric shock.

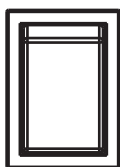

POWER  
On/Off

**Power Switch.** This is the On/Off switch.

**Power User Tip:** If connecting multiple loudspeakers to the same electrical circuit, make sure that adequate line current is available. Maximum current draw for each ULT-series loudspeaker is 5.45 Amps.

3.4 Hookup diagrams

3.4.1 Basic Hookup Diagram

Basic Hookup Diagram

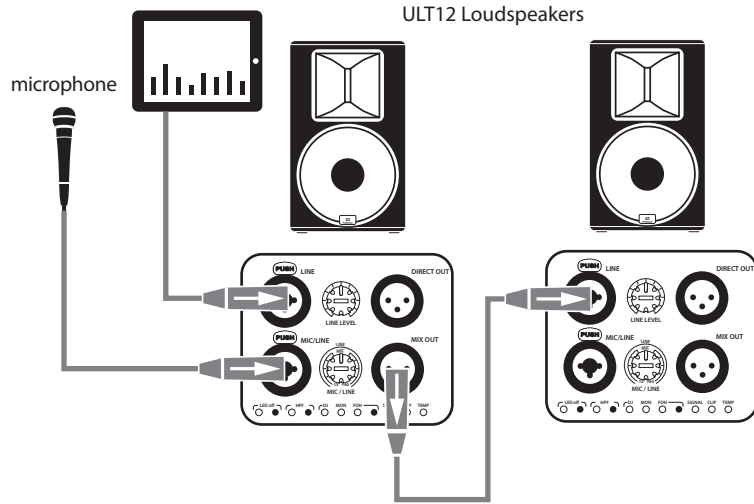

3.4.2 Typical Band Setup Diagram

Typical Band Setup Diagram

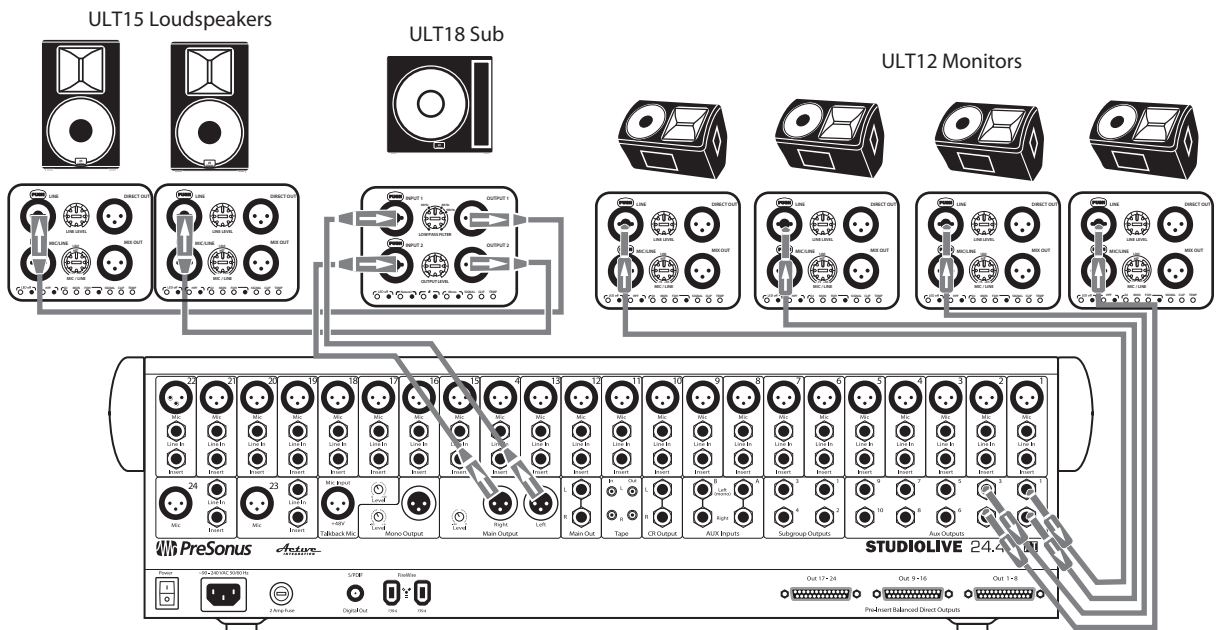

## 4 Loudspeaker Placement and System Configuration

ULT-series full-range loudspeakers are designed to reproduce an input signal with extreme fidelity, maintaining near-flat frequency and phase response at all levels up to the threshold of clipping. However, the performance of any loudspeaker will be influenced by the surrounding acoustics. Difficult room acoustics combined with improper loudspeaker placement can interfere with achieving the fidelity performance of which your ULT-series loudspeakers are capable. To help you get the most out of your system, this Section has been included to guide you around some of the pitfalls of configuring a successful PA system.

### 4.1 Recognizing Problem Rooms

In most live environments, the room is rarely designed to maximize the listening experience. More often than not, money is spent on aesthetic appeal rather than acoustic treatment. For large-scale tour productions, venues are often sports arenas that have been designed to maximize crowd noise. Smaller music venues are often chosen for location or architectural aesthetics, rather than music reproduction. While an empty warehouse or old wine cellar might make a great environment to hang out in, it's necessary to recognize and correct what that space does to the sound system in order to optimize the PA's performance in the venue.

In general, the following physical features of a room can affect a sound system's performance:

- Room Size
- Construction
- Reflectivity

The size of the room directly impacts how well certain frequencies will be reproduced. For example, if you measure a room diagonally, you will discover how well that room will be able to sustain low frequencies. This may seem odd until you think about the physical size of audio waves at various frequencies. For example, a 50 Hz wave is about 22.6 feet long. (To calculate how big an audio wave is, divide the speed of sound—1,130 ft./second—by the frequency. For a 50 Hz wave,  $1,130/50 = 22.6$  ft.) So a room that is 45 feet on the diagonal is going to regenerate low frequencies more effectively than a room that is 15 feet on the diagonal.

When a room's width or length correlates directly to the size of a waveform at a specific frequency, a standing wave can occur where the initial sound and the reflected sound begin to reinforce each other. Let's say we have a long, narrow room where the distance from one side to the other is 22.6 feet. When a 50 Hz wave bounces off the wall, the reflective wave travels right back along the same path and bounces off the other wall and cycle repeats. In a room such as this, 50 Hz reproduces very well, maybe too well. So any mix will have a heavier low-end.

Additionally, low frequency waves are powerful enough to cause the walls, ceiling, and even the floor to flex and move. This is called diaphragmatic action, and it dissipates energy and strips away the low-end definition. So if you're in an old cotton mill, and the walls and floor are made of thick concrete that don't vibrate much, the bass response is going to be much more powerful than if you've set up a show in an old warehouse where the walls are made of barge board and tin.

### 4.1.1 Vertical Coverage

It is important to keep in mind that vertical coverage is just as important as horizontal coverage. If you are using a ground stack approach with pole mount, make sure your coverage matches the listening plane. Suspension of speakers will provide even further control.

Each ULT-series full-range loudspeaker features dual-position pole mounts. Using the 6° downward tilt mount will focus the loudspeaker's energy onto the audience and avoid destructive reflections. This is ideal for situations where the loudspeaker is mounted atop a tripod stand and placed on a stage, or where the pole-mounted loudspeaker is on the floor and the coverage area is relatively shallow (conference, coffee house, etc.).

More information on Horizontal Coverage placement can be found in Section 4.2.

#### Flat Floor with Stage

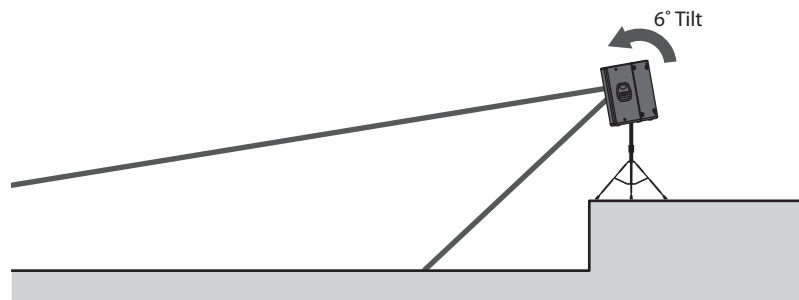

#### Elevated Floor

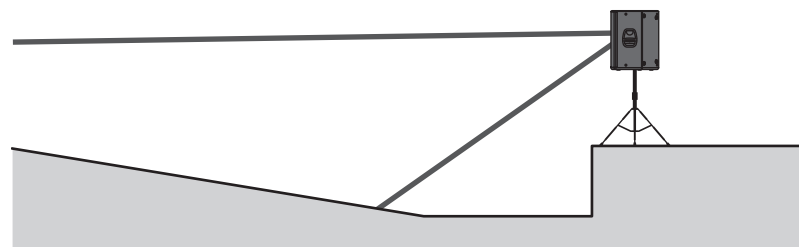

#### No Stage Flat Floor

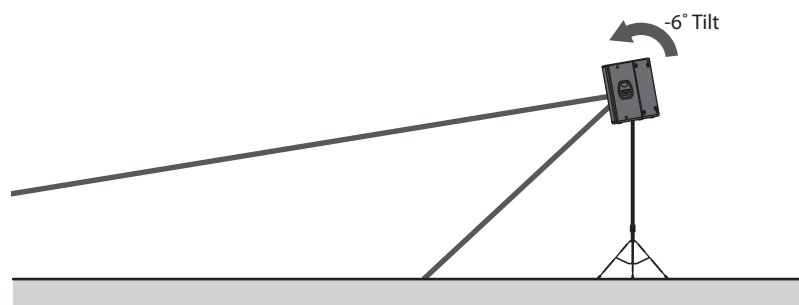

### 4.1.2 Wall and Corner Loading

Very low frequencies are not directional, so they radiate out of the sides and back of the loudspeaker, as well as out of the front. If you place a loudspeaker against a wall, the rear sound propagates back into the room. This can increase output of bass frequencies as much as 6 dB, and as much as 12 dB if you put the loudspeaker in a corner.

In order to have the most control over your sound, it's best to always start with the flattest response, so you normally should avoid wall and corner placement. On the other hand, if you need some extra bass boost, this technique may be worth a try. It is important to be aware of what's happening and be prepared to take advantage of it or compensate for it.

**Power User Tip:** *Because a floor monitor placed on the stage is unavoidably subject to half-space loading, the Monitor Preset on your ULT-series full-range loudspeaker is specifically designed to compensate for bass buildup and maintain a tight mid-bass response.*

### 4.1.3 Maintain a High Direct-to-Reverberant Ratio

Another way a room interacts with sound waves is through reflectivity. Like most room anomalies, reflections can be good and bad. Consider the effect of a cathedral's reflections on a choir or a piano. This type of reverberation (reverb) is quite desirable. But not all reverb is good reverb. Reflections can also cause comb filtering. For example, if a speaker is placed near a reflective surface (such as a concrete wall), the direct sound coming from the speaker and the reflected sound coming from the wall can arrive at the listener's ears out of phase with each other, causing cancellation and reinforcement. If they're 180 degrees out of phase with respect to each other, they will cancel each other out.

If you are using your loudspeakers in a reverberant environment, position them so that as much sound as possible is focused on the audience area and steered away from reflective surfaces. ULT-series full-range loudspeakers have a nominal 110-degree horizontal and 50-degree vertical coverage pattern. When you do your placement and positioning, it's a good idea take some time to do a "walk around" of your loudspeakers, playing either pink noise or program material, so you get a feel for how the sounds are translating into the room.

## 4.2 System configuration suggestions

The following subsections will demonstrate some system configurations for common rooms. The size and shape of your room and the application for which it will be used determine, to a large extent, how many speakers you will need and where they should be placed. In every situation, keep in mind two important design factors: your loudspeaker's coverage pattern and half-space loading.

Both full-range ULT-series loudspeaker offers offer the same 110°H x 50°V coverage pattern. Be sure to pay close attention to these angles when using your speakers. Rotating the cabinet changes the horizontal and vertical coverage. Both full-range ULT-series loudspeakers support rotating the horn if you would like to install them in a horizontal orientation but still maintain the 110° x 50° dispersion pattern.

When configured for stereo use, make sure the cabinets are not placed too wide for the room or too far back into the corners. Too wide of a placement will direct too much energy onto the walls and can potentially add destructive interference to the room. Adjust the left and right speakers, as well as the toe-in angle, to produce the best stereo image. If a room is very narrow, a mono cluster might be a better choice than stereo.

Wherever you place your loudspeakers, you should be aware of half-space loading. Half-space loading occurs when a speaker comes in close contact with, or touches, a hard surface like a floor or wall. As its name indicates, this type of summation happens when the circular radiation of the speaker is blocked by a hard surface and forced to radiate in a crescent shape. Depending on the proximity and position, there may be a boost in low-frequency energy.

Testing your speaker placement and doing some critical-listening tests will help determine the best final location for your loudspeaker system.

If your speakers are sitting on the floor, you can expect a certain amount of half-space loading. If you are using your speakers as floor wedges, you might want to experiment with using the High Pass Filter to reduce low energy. In some cases, this might improve intelligibility. Using the Monitor preset will also help you get the best use out of your ULT-series full-range loudspeakers in this position.

#### 4.2.1 Stereo System

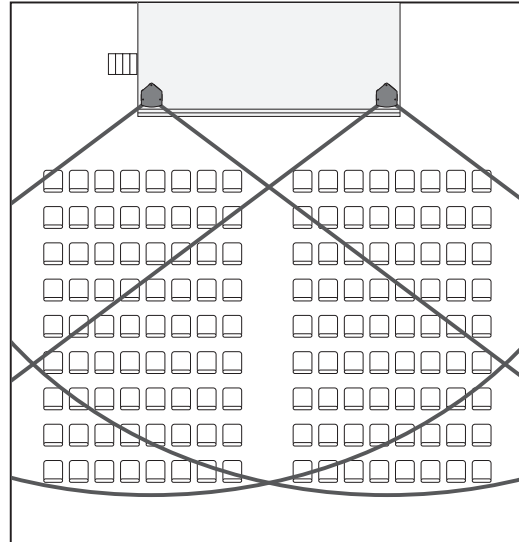

A stereo system allows panning and adds depth to the acoustic image. This is good for speech reinforcement and greatly enhances live or pre-recorded music. Locate speakers to give the best horizontal coverage. Ensure that the listeners are well covered by the pattern.

#### 4.2.2 Mono Cluster with Down Fill

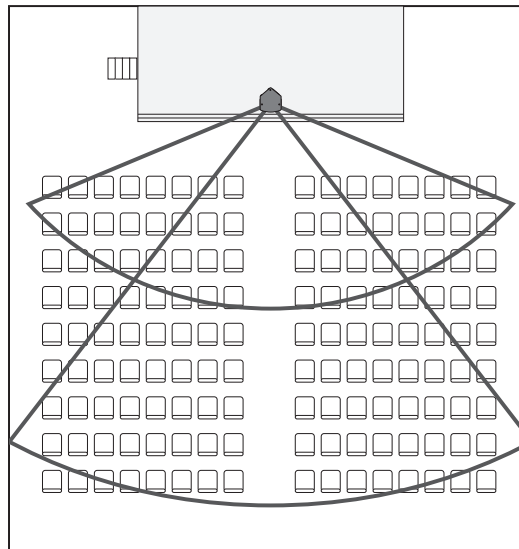

Center or mono systems can provide a simple, economical solution for venues where speech intelligibility is the priority, rather than music. As with a stereo system, make sure the coverage pattern of the speaker focuses the energy on the audience.

This graphic actually shows two speakers. The upper speaker is for throwing to the back of the room, and the lower speaker covers the space in the front of the room, closest to the stage.

### 4.2.3 LCR Systems

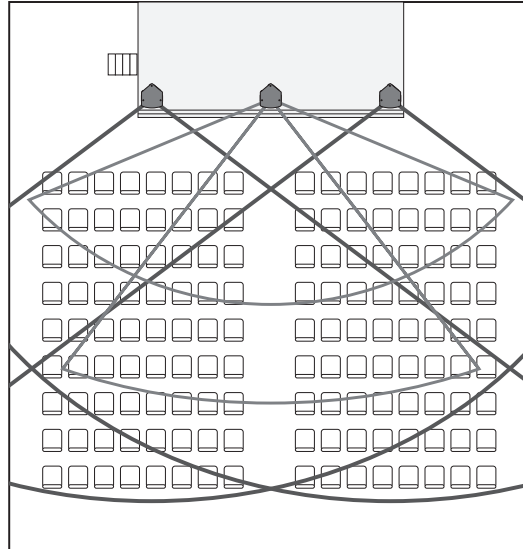

An LCR system is a stereo system with a center speaker added. This configuration allows panning and adds depth to the acoustic image. This type of system will provide more control than a basic stereo system and is ideal in situations where music and speech intelligibility are equally important.

### 4.2.4 Monitor Systems

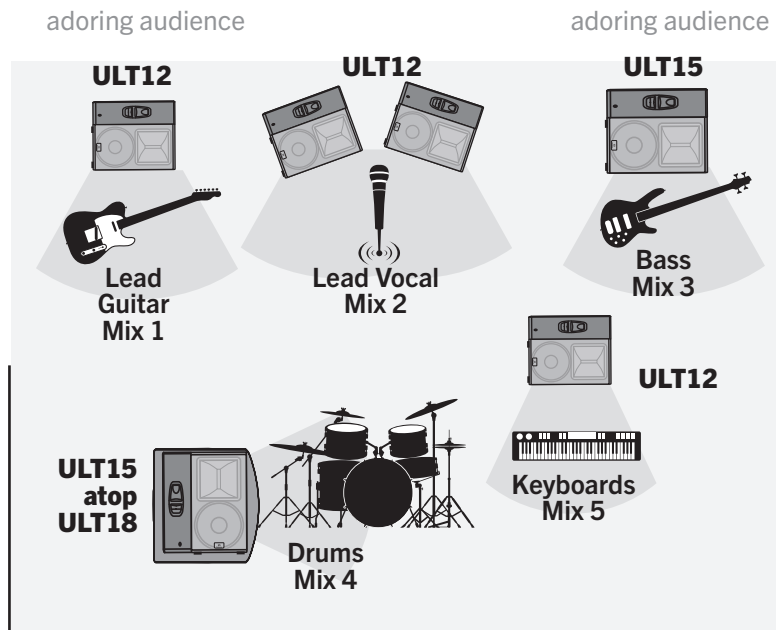

Above is a typical stage-monitor layout for a five-piece band. For musicians (such as a vocalist) who don't require a lot of low-frequency energy in their floor wedge, we suggest using a ULT12. For musicians that need a little more bass, the ULT15 is preferable. The drum monitor in this example is a full-range, 3-way system (ULT15 atop ULT18). For smaller stages, a ULT15 atop a low tripod or in the horizontal floor-wedge position will be more than adequate.

### 4.2.5 Ground Stacking

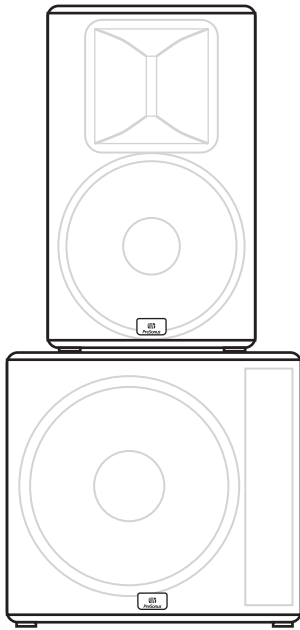

ULT-series full-range loudspeakers have nonskid rubber feet on the bottom for upright front-of-house use and nonskid rubber feet on one side for stage-monitor applications.

If your application is primarily portable, PreSonus Loudspeakers can be easily ground stacked and configured for a variety of venues. When ground stacking, make sure all speakers are securely anchored to the floor using load straps or other anchors. Rubber mats can also be utilized between cabinets to prevent boxes from “walking.” This is particularly important if the speakers are accessible to the public.

Check that the surface the speakers are to be stacked on is level, even, and has sufficient structural integrity to support the speakers. If ground stacking on a portable stage, make sure you know what is directly below the speaker stack.

**⚠ WARNING:** Placement on improper or unstable surfaces could cause the loudspeaker to topple, which could result in serious injury or death.

### 4.2.6 Pole Mount

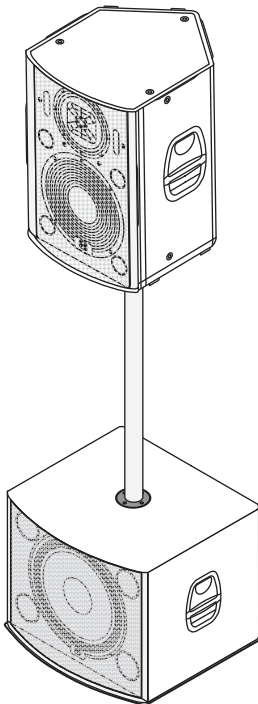

Both full-range ULT-series loudspeakers are equipped with 35 mm pole socket that allows the speaker to be mounted on a speaker stand or on a pole over an ULT18 subwoofer. This pole socket allows for straight 90° vertical mounting or for tilting the full-range loudspeaker down 6° while on a pole.

When using a tripod speaker stand, extend the legs to provide the most stable support to the speaker so that it cannot be tipped over. It is highly recommended that tripod stands be placed away from foot traffic. If the stands are to be used outdoors, theatrical sand bags may be placed on the legs to provide some protection against wind load. When using the tilt-mount, make sure that one of the tripod legs is oriented directly below the tilt angle.

ULT-Series full-range loudspeakers also may be mounted on top of a ULT18 subwoofer using the optional SP1BK threaded subwoofer pole. This pole was designed to be secured the ULT18 subwoofer and have been pull- and tilt-tested for safety with both full-range ULT-series loudspeakers.

**⚠ WARNING:** Do not substitute a longer pole from a third-party supplier. Use of a longer pole than specified could cause instability, which in turn could result in serious injury or death.

**⚠ WARNING:** Use proper lifting techniques and safety precautions when mounting a ULT-series loudspeaker on a the SP1BK Subwoofer Pole or a speaker stand. When mounting atop a speaker stand, verify that it is rated to support the weight of your ULT-Series loudspeaker. *The weight of each model can be found in Section 5.1.*

**⚠ WARNING:** Placement on improper or unstable surfaces could cause the loudspeaker to topple, which could result in serious injury or death.



### 4.3 Rigging and Safety

This section has been created as a reference for safe rigging and mounting practices. It is not an installation tutorial. PreSonus ULT-series loudspeakers are professional products and not intended for consumer use. Installation of ULT-series Loudspeakers should only be undertaken by a qualified systems integrator or a professional rigger. Every audio project is unique and a licensed and insured professional should be consulted to guarantee the safety and performance of the installed system. The installer must have a complete understanding of the design intent as well as knowledge of safe installation techniques to create a successful project.

Understanding safe rigging and mounting practices will provide these benefits:

- Proper coverage of listening area with accurate speaker placement.
- Best installation methods will be utilized with regard to safety, performance, aesthetics, and cost.
- Minimal wasted time during installation.

#### 4.3.1 Safety is the Priority

 **WARNING:** Failure to observe the following safety precautions may result in severe injury or death. Installations such as described in this guide should only be attempted by a trained professional.

- Inspect all the components associated with the project for damage before assembly. Any suspect parts should not be used, and the component manufacturer should be contacted to arrange for replacement parts.
- Read all instructions shipped with selected speaker or rigging products. Make sure you fully understand all components.
- Always make sure that the structure the loudspeaker is to be suspended from has been approved by the building or structural engineer and will support the weight of all the components of the speaker system including speakers, speaker cable, wire rope, etc.
- Make sure all installation crew members are trained for loudspeaker rigging and mounting and are in compliance with applicable local laws. Local government offices can help with this information.
- Make sure that all relevant health and safety regulations are known and followed by the installation crew.
- Suspended installations must be completed or supervised by a certified rigger.
- The system should be designed so that it is a static suspension. There should be no dynamic or shock loading.
- Personal protective equipment (hardhats, steel-toed footwear, safety glasses, etc.) should be worn at all times by the installation crew.
- If called for in the design, make sure all installation personnel are trained to work at height and have certifications for scissor lifts, theatrical hoists, etc.
- Make sure all lifting equipment (slings, span-sets, deck chain, scaffolding, etc.) is in good working order. Thoroughly inspect all components prior to use.
- Keep a tidy workplace. Do not leave tools, rigging items, etc., on top of loudspeakers during installation. Loose items can fall and cause injury.
- Never leave the system unattended during the installation process. Make sure that the workspace is isolated from public access. No one should be allowed to pass beneath the loudspeakers during installation.
- Do not suspend any other components or loudspeakers from PreSonus ULT-series loudspeakers. If secondary steel safeties are required, they should be installed once the entire system is at operating height and before public access is allowed.

### 4.3.2 Suspending the Loudspeaker

A minimum of three suspension points must be used per speaker to safely suspend the ULT-series full-range loudspeakers. Two wires fixed symmetrically to the front of the cabinet to hold the weight and one wire attached to the back for tilt will satisfy this requirement. Select the strongest overhead structure available for the two front points and, if possible, two independent points to allow one to act as a backup. Attach the two front points first and then adjust tilt angle to ensure the load is safely suspended during installation. If additional pan or height adjustments are needed, make sure to follow this rule as well.

**SUPPORTED:** Two front rigging points plus a pull-back

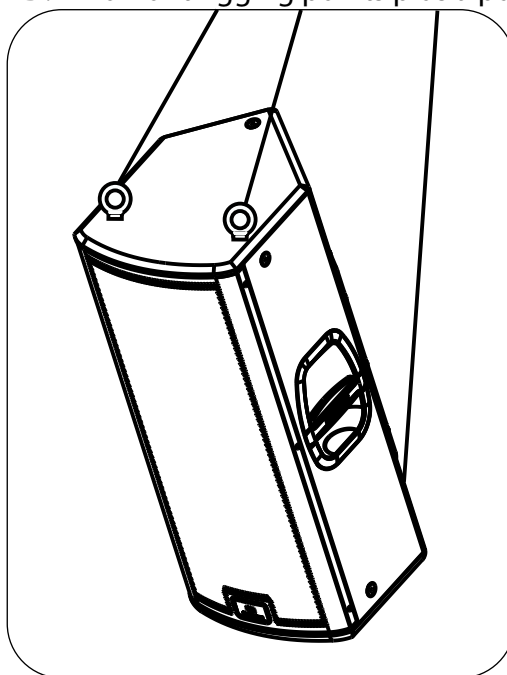

Do not suspend any other items from PreSonus ULT-series loudspeakers.

**NOT SUPPORTED:** One Loudspeaker attached to another

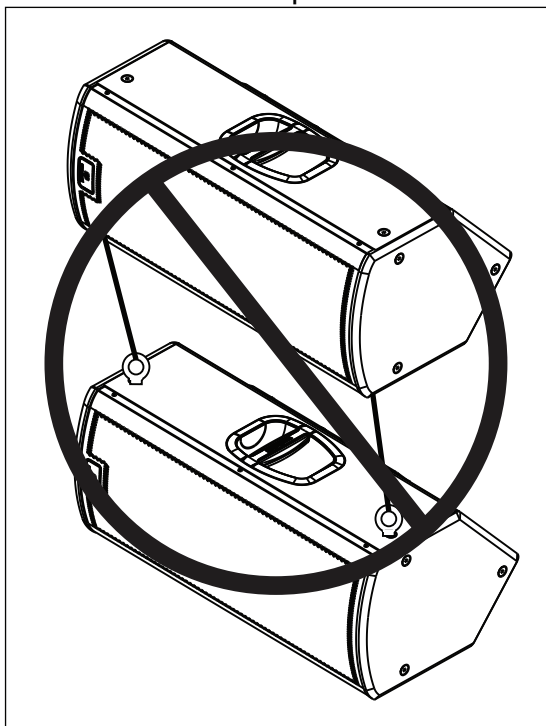

The ULT18 requires a minimum of four suspension points to be used. Again, select the strongest overhead structure available. The ULT18 can be flown using the four M10 point on the top or the side.

#### SUPPORTED: Four Rigging Points

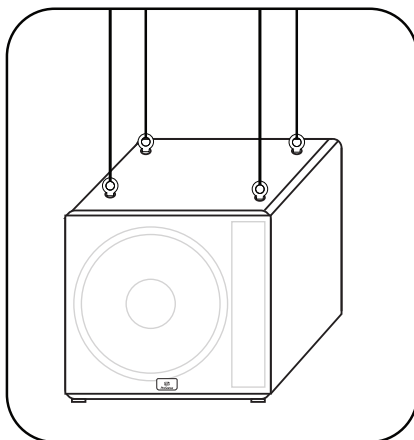

PreSonus offers an M10 Kit that includes four (4) forged-shoulder steel M10 eyebolts. This kit is to be used with the ULT12, ULT15, and ULT18 M10 suspension points. These bolts are specifically designed for safe suspension of PreSonus ULT-series Loudspeakers and must not be substituted. These eyebolts are not a common hardware store item. Please read all included information. A minimum of three (3) eyebolts per per full-range cabinet and four (4) eyebolts per ULT18 Subwoofer must be used for safe suspension.

When using the M10-AI Kit, please remember that the eyebolt strength rating will vary with the pull angle. It is extremely important to observe appropriate pull angles when suspending any loudspeaker with eyebolts. Suspending an object with eyebolt should always be done in a way that ensures the resultant forces are within the allowed pull angles.

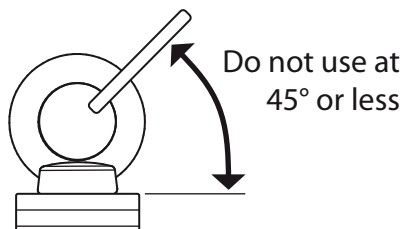

### 4.3.3 Precautions

ULT-series loudspeakers, like all electrical devices, must be protected from liquids or excessive moisture. They are not designed for outdoor use during inclement weather. If you are using your ULT-series loudspeakers outside when rain or other moisture-laden weather occurs, immediately power down your loudspeakers and protect the cabinets with waterproof coverings.

The amplifiers in ULT-series loudspeakers are convection cooled via the rear-panel heatsink. Free airflow must be maintained around and behind the heatsink, with a minimum clearance of six inches behind the cabinet. Make certain the heatsink is kept clear of any adjacent materials, such as stage curtains, that could impede airflow.

## 5 Technical Information

### 5.1 Specifications

#### 5.1.1 ULT12

Type	Active 2-way
LF Driver	12" (2.5" Voice Coil)
HF Driver	1" Exit (1.75" Voice Coil)
Amplifier Type	Class D
Total System Power	1300W Peak (650W RMS)
LF Driver Power	1000W Peak (500W RMS)
HF Driver Power	300W Peak (150W RMS)
Frequency Range	55 Hz – 18 kHz (+/- 3 dB)
Crossover Frequency	1.6 kHz
Maximum Peak SPL	135 dB
Nominal Dispersion (H x V)	110° x 50°
Inputs	1 Line (combo), 1 mic/line(combo)
Outputs	Direct Line Out (XLR), Mix Out (XLR)
User Controls	Line Level, Mic Level, Preset Select, HPF On/Off, LED On/Off
Indicators	Signal, Clip, Over Temp
Enclosure	15 mm birch
Mounting	Dual-position pole mount, 12 M10
Dimensions (H x W x D)	25.25" x 14" x 13.9" (641 mm x 356 mm x 353 mm)
Weight	52 lbs. (23.6 kg)

#### 5.1.2 ULT15

Type	Active 2-way
LF Driver	15" (2.5" Voice Coil)
HF Driver	1" Exit (1.75" Voice Coil)
Amplifier Type	Class D
Total System Power	1300W Peak (650W RMS)
LF Driver Power	1000W Peak (500W RMS)
HF Driver Power	300W Peak (150W RMS)
Frequency Range	52 Hz – 18 kHz (+/- 3 dB)
Crossover Frequency	1.6 kHz
Maximum Peak SPL	136 dB
Nominal Dispersion (H x V)	110° x 50°
Inputs	1 Line (combo), 1 mic/line(combo)
Outputs	Direct Line Out (XLR), Mix Out (XLR)
User Controls	Line Level, Mic Level, Preset Select, HPF On/Off, LED On/Off
Indicators	Signal, Clip, Over Temp
Enclosure	15 mm birch
Mounting	Dual-position pole mount, 12 M10
Dimensions (H x W x D)	28.5" x 17.25" x 16" (234 mm x 438 mm x 406 mm)
Weight	59 lbs. (26.8 kg)

### 5.1.3 ULT18

Type	Active Subwoofer
LF Driver	18" (4" Voice Coil)
Amplifier Type	Class D
Total System Power	2000W Peak (1000W RMS)
Frequency Range	42 Hz – 250 kHz Variable (+/- 3 dB)
Crossover Frequency	90 Hz
Maximum Peak SPL	135 dB
Inputs	2 Line (combo)
Outputs	2 Line (XLR)
User Controls	Output Level, Variable Low Pass Filter, Preset Select, Polarity On/Off, LED On/Off
Indicators	Signal, Clip, Over Temp
Enclosure	18 mm birch Inputs
Mounting	12 M10, 4 Ground Stack Provisions
Dimensions (H x W x D)	22.5" x 24.5" x 25" (572 mm x 622 mm x 635)
Weight	95 lbs. (43 kg)

### 5.2 Optional Accessories

The following optional accessories are available through your PreSonus dealer.

#### Flying Kit (M10AI-KIT)

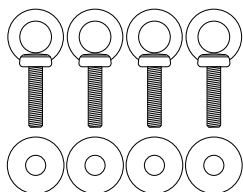

The M10 flying kit is intended for use with all ULT-series full-range models and includes four M10 eyebolts.

#### Protective Soft Covers

These protective soft covers are custom-fitted for each model. Tough, rip-resistant material protects loudspeaker cabinets during transportation. A cutout allows access to the handles. Order according to speaker model number.

#### Custom Pole (SP1BK)



Use the custom, threaded pole to mount a ULT-series full-range loudspeaker over an ULT18 subwoofer. Pole lengths have been measured and tested for system stability.

## 6 Troubleshooting and Warranty

### 6.1 Support and Troubleshooting

Please check the PreSonus Web site ([www.presonus.com](http://www.presonus.com)) regularly for software information and updates, firmware updates, and support documentation, including frequently asked questions.

Online technical support is available at [www.presonus.com/support/Contact-Technical-Support](http://www.presonus.com/support/Contact-Technical-Support).

Technical support is available via email at [techsupport@presonus.com](mailto:techsupport@presonus.com).

PreSonus telephone technical support is available to customers in the USA on Monday through Friday from 9 a.m. to 5 p.m. Central Time by calling 1-225-216-7887. Customers outside of the USA should contact their national or regional distributor for telephone technical support. A list of international distributors is provided at [www.presonus.com/buy/international\\_distributors](http://www.presonus.com/buy/international_distributors).

#### **Loudspeaker won't turn on.**

If the loudspeaker is plugged in, and the switch is on, but no LEDs illuminate, check the following:

- Make sure the power cord is fully and securely inserted in the IEC receptacle and in the wall outlet.
- Confirm that the AC outlet is "live," using a tester or other device (such as a lamp) that is known to be working.
- If the loudspeaker still shows no power, it is possible that the internal fuse may have opened. This is not a user-serviceable part. Contact PreSonus technical support for more information.

#### **Loudspeaker is on but there's no sound.**

Check to make sure the signal is "live" from an external source. Check that output faders are up on the mixing console and check the output level using headphones.

If another speaker in a stereo configuration is working, swap input cables. If the problem moves, replace the faulty cable.

If the loudspeaker has been producing sound at high levels and then stops, it may have gone into thermal muting. Allow the unit to cool, and make sure the heat sink has sufficient ventilation.

#### **Sound breaks up intermittently.**

Check the input sources, using headphones, if possible, to determine if the problem is with the source.

Check console outputs and all input and loop-thru connectors to make sure they are securely plugged in. If the problem persists, try replacing cables with spares.

#### **Distorted sound.**

Check the input sources, using headphones, if possible, to make sure the signal is not already distorted.

Check the clip indicator on the rear panel. If the LED is lit all or most of the time, reduce the input levels.

**Loudspeaker has hum or buzz.**

Nearly all hum and buzz problems are related to cable grounding. With the loudspeaker at low volume, remove input and output cables, one at a time, until the noise disappears. Try replacing the suspect cable.

If you are using two-conductor cables with unbalanced 1/4" connectors, try replacing with balanced cables using TRS or XLR connectors.

Try plugging loudspeakers and the external mixer into outlets that share a common ground. If necessary, use an extension cord to plug the external mixer into the same outlet as the loudspeaker—but do not run the AC cord bundled with the signal cables.

**6.2 Warranty**

PreSonus's warranty obligations for this hardware product are limited to the terms set forth below:

**How Consumer Law Relates To This Warranty:**

THIS WARRANTY GIVES YOU SPECIFIC LEGAL RIGHTS, AND YOU MAY HAVE OTHER RIGHTS THAT VARY FROM STATE TO STATE (OR BY COUNTRY OR PROVINCE). OTHER THAN AS PERMITTED BY LAW, PRESONUS DOES NOT EXCLUDE, LIMIT OR SUSPEND OTHER RIGHTS YOU MAY HAVE, INCLUDING THOSE THAT MAY ARISE FROM THE NONCONFORMITY OF A SALES CONTRACT. FOR A FULL UNDERSTANDING OF YOUR RIGHTS YOU SHOULD CONSULT THE LAWS OF YOUR COUNTRY PROVINCE OR STATE.

**PreSonus Products And EU Statutory Warranty:**

When you purchase PreSonus products, European Union consumer law provides statutory warranty rights in addition to the coverage you receive from the PreSonus limited warranty. A summary of the EU Statutory Warranty and the PreSonus Limited Warranty is below:

	EU Consumer Law	PreSonus Limited Warranty
Repair or Replacement Coverage For	Defects present when customer takes delivery	Defects arising after customer takes delivery
Warranty Period	2 years (minimum) from original date of purchase (unless superseded by PreSonus)	1 year from original date of purchase (unless superseded by PreSonus)
Cost of Coverage	Provided at no additional cost	Included at no additional cost
Who to contact to make a claim	The seller	PreSonus technical support for your region

**What This Warranty Covers:**

PreSonus Audio Electronics, Inc., ("PreSonus") warrants defects in material and workmanship in PreSonus-branded products under normal use. This Limited Warranty applies only to hardware products manufactured by or for PreSonus that can be identified by the PreSonus trademark, trade name, or logo affixed to them.

**Exclusions and Limitations:**

This warranty does not cover the following:

1. Damage caused by accident, abuse, improper installation, failure to follow instructions in the applicable owner's manual or improper operation, rental, product modification, alteration, or neglect.
2. Damage from improper grounding, faulty wiring (AC and signal), faulty equipment, or connection to a voltage range outside published specifications (see applicable owner's manual).
3. Damage to drivers or diaphragm assemblies found to have burnt voice coils from over/under driving or signal surge from another device.
4. Damage occurring during shipment or improper handling.
5. Damage caused by repair or service performed by persons not authorized by PreSonus.
6. Products on which the serial number has been altered, defaced, or removed.
7. Products purchased from an un-authorized PreSonus dealer (products that have transferable warranties are excluded from this provision provided the customer and the product are registered with PreSonus).

**Who This Warranty Protects:**

This Warranty protects only the original retail purchaser of the product (products that have transferable warranties are excluded from this provision provided the customer and the product are registered with PreSonus)

**How Long This Warranty Lasts:**

The Warranty begins on the original date of purchase from the retail purchaser and the duration is as follows:

1-Year Limited Warranty		
Product Category	Model	Transferable
Recording Interfaces	AudioBox iOne, AudioBox iTwo, AudioBox Stereo, AudioBox Studio, AudioBox USB, AudioBox VSL (1818, 44, 22), FireStudio Project, FireStudio Mobile, FireStudio Mobile Studio, Music Creation Suite	No
Pre-amplifiers	ADL600, ADL700, BlueTube DP V2, DigiMax D8, Eureka, RC500, StudioChannel, TubePre V2	No
StudioLive Mixers	SL-1642, SL-2442, SL-1602, SLM16.4.2 AI, SLM24.4.2 AI, SLM32.4.2AI	No
Monitoring & Controlling	Eris, Central Station Plus, FaderPort, HP4, HP60, Monitor Station, Monitor Station V2, R65, R80, Sceptre, Temblor	No
Signal Processing	ACP88	No
Accessories	Covers, Dolly, PRM1 mic, Sub Pole, Breakout Cables, Power Supplies, M10 Kit	No
3-Years Limited Warranty		
Product Category	Model	Transferable
Live Sound	StudioLive AI 328, 312, 315, 185, ULT12, ULT15, ULT18	Yes

**What PreSonus Will Do:**

PreSonus will repair or replace, at our sole and absolute option, products covered by this warranty at no charge for labor or materials. If the product must be shipped to PreSonus for warranty service, the customer must pay the initial shipping charges. PreSonus will pay the return shipping charges.



### How to Get Warranty Service (USA):

1. You must have an active user account with PreSonus and your hardware must be on file with your account. If you do not have an account, please go to: <http://www.presonus.com/registration> and complete the registration process.
2. Contact our Technical Support Department at (225) 216-7887 or log a support ticket at: <http://support.presonus.com>. TO AVOID THE POSSIBILITY OF SENDING IN A PRODUCT THAT DOES NOT HAVE A PROBLEM, ALL SERVICE REQUESTS SHALL BE CONFIRMED BY OUR TECH SUPPORT DEPARTMENT.
3. The return authorization number as well as shipping instructions shall be provided after your service request is reviewed and confirmed.
4. The product should be returned for service in the original product packaging. Products may be shipped in a manufactured "flight" or "road" style cases but PreSonus will NOT cover any shipping damage to these cases. Products that are not shipped in the original product package or a manufactured case may not receive a warranty repair, at PreSonus's sole discretion. Depending on the product model and the condition of your original packaging, your product may not be returned to you in the original packaging. The return shipping box may be a generic box that has been fitted for that model tested if the original gift box is not available.

### How to Get Warranty Service (outside of USA):

1. You must have an active user account with PreSonus and your hardware must be on file with your account. If you do not have an account, please go to: <http://www.presonus.com/registration> and complete the registration process.
2. Contact the Technical Support/Service Department for your region at [http://www.presonus.com/buy/international\\_distributors](http://www.presonus.com/buy/international_distributors) and follow procedures provided by your PreSonus contact.

### Limitation of Implied Warranties:

ANY IMPLIED WARRANTIES, INCLUDING WARRANTIES OF MERCHANTABILITY AND FITNESS FOR A PARTICULAR PURPOSE, ARE LIMITED IN DURATION TO THE LENGTH OF THIS WARRANTY.

Some states, countries, or provinces do not allow limitations on how long an implied warranty lasts, so the above limitation may not apply to you.

### Exclusion of Damages:

PRESONUS'S LIABILITY FOR ANY DEFECTIVE PRODUCT IS LIMITED TO THE REPAIR OR REPLACEMENT OF THE PRODUCT, AT PRESONUS'S SOLE OPTION. IF PRESONUS ELECTS TO REPLACE THE PRODUCT, THE REPLACEMENT MAY BE A RECONDITIONED UNIT. IN NO EVENT WILL PRESONUS BE LIABLE FOR DAMAGES BASED ON INCONVENIENCE, LOSS OF USE, LOST PROFITS, LOST SAVINGS, DAMAGE TO ANY OTHER EQUIPMENT OR OTHER ITEMS AT THE SITE OF USE, AND, TO THE EXTENT PERMITTED BY LAW, DAMAGES FOR PERSONAL INJURY, OR ANY OTHER DAMAGES WHETHER INCIDENTAL, CONSEQUENTIAL OR OTHERWISE, EVEN IF PRESONUS HAS BEEN ADVISED OF THE POSSIBILITY OF SUCH DAMAGES.

Some states, countries, or provinces do not allow limitations on how long an implied warranty lasts, so the above limitation may not apply to you.

If you have any questions about this warranty or service received, please contact PreSonus (USA) at (225) 216-7887 or one of our authorized international distributors at: [http://www.presonus.com/buy/international\\_distributors](http://www.presonus.com/buy/international_distributors).

Product features, design, and specifications are subject to change without notice.



## Added bonus: PreSonus' previously Top Secret recipe for...

# Jambalaya

### Ingredients:

- 5 lbs link andouille sausage
- 3 lbs boneless chicken
- 2 lbs ground beef
- 3 lbs onions (yellow or purple)
- 2 stalks of celery
- 1 lb bell peppers (green or red)
- 1 batch green onions
- 3 lbs rice
- Tony Chachere's Cajun Seasoning
- 1 bottle chicken stock concentrate (or 3 cubes chicken bullion)
- 1 can Rotel tomatoes with chilies, diced (regular hot)
- Tabasco sauce

### Cooking Instructions:

1. In a 16 qt. pot or larger, slice link sausage and pan-fry until brown.
2. Add ground beef and brown.
3. Do not remove from pot Add diced onions, celery, and bell peppers, 1 can Rotel Original diced tomatoes with chilies, 3 oz concentrate chicken stock, ½ teaspoon of Cajun seasoning, 1 teaspoon of Tabasco hot sauce (or more...maybe lots more).
4. Cook until onions are translucent.
5. Add chicken and cook until it turns white.
6. Add diced green onions, 1 tsp. salt, ½ gallon water and bring to a boil.
7. Add rice and bring to a boil. Cook on high for 8 minutes, covered, stirring every 2 minutes
8. Cook covered on low for 10 minutes, stirring only once.
9. Turn off and let sit for 30 minutes.
10. Serve and enjoy!

**Serves 20**

# ULT-series

## Loudspeakers

### Owner's Manual

