



Product Description

Conceived, engineered and built with precision in the United Kingdom, VX Series represents the latest evolution of Tannoy's core philosophies in professional loudspeaker design. VX 12.2Q is an entirely new class of device that delivers high SPL, low distortion and controlled audio coverage. It provides a higher impact solution for medium-to-large scale sound reinforcement, particularly for high-SPL applications such as bars and clubs. It is also well suited for mid-scale portable/live PA applications.

The VX 12.2Q is built around two discrete transducers, a 1 x 300 mm (12") PowerDual™ with Q-Centric waveguide and a 1 x 300 mm (12") bass driver for greatly improved LF extension. Both are mounted in a rugged birch plywood cabinet with aesthetically profiled edges and Airnet™-backed, powder-coated steel grille. The latest higher power handling version of Tannoy's exclusive point source, constant directivity PowerDual™ drive unit technology, coupled with the QCW device, brings best of both worlds – true point source performance combined with highly controlled 75 x 40 degree dispersion, resulting in less unwanted shading effects and optimized forward gain. The driver assembly can be rotated 90 degrees in the cabinet to allow for versatile mounting without compromise to dispersion requirements. For greater system headroom, the 3-way VX 12.2Q system also can be internally reconfigured for bi-amp operation, enabling connection of separate amplifier channels for the LF driver and PowerDual driver.

Audio connection is via flush-mounted, recessed termination panel with both NL 4MP speakON and connector strip. An extensive range of high performance steel mounting hardware is available, custom designed for VX 12.2Q. This includes a yoke bracket for wall and ceiling location as well as eyebolt location points. VX 12.2Q also can be used as a floor wedge thanks to the cabinet form factor. Ergonomic Integrip™ recessed handles at each end makes one- and two-handed lift of the cabinet easy for optimum portability.

The VX 12.2Q is available in black or white textured paint finish as standard, with matching grilles, and is also available in custom matched RAL colours as an option. A weather protected specification (WP) is also available as an option. Thus includes LINE-X cabinet outer-coating, internal sealing, and treated transducers with perforated Grade 316 stainless steel grilles. All steel hardware is upgraded to Grade 304 stainless steel, while all connector panel points are protected by a cover plate and weather-proof cable gland. Additional lead time applies to all non-standard specifications.

Features

- 305 mm (12") PowerDual full-range driver with QCW™ delivering best of both worlds – true point source combined with new horn design allowing tight vertical coverage.
- Discrete 305 mm (12") bass driver for extended LF performance
- Well defined 75 x 40 degree dispersion for optimum coverage and forward gain
- Peak output (full range passive) 132 dB SPL @ 1 m, recommended amp power 1000 W @ 8 ohms
- Versatile mounting via optional custom designed hardware
- Integrip™ handles ergonomically integrated into top and bottom of cabinet
- Pole-mountable for optimum portability
- Flush-mounted termination panel with NL4 speakON and barrier strip connections
- Rugged birch plywood enclosure
- Available in black or white textured paint finish – custom colours optional

Applications

- Theatres, Auditoria and Houses of Worship
- Medium scale PA.
- Bars and nightclubs
- Portable and installed corporate AV
- Theme parks and leisure venues
- Gymnasiums and small/medium sports arenas
- Cinemas

Tannoy (Direct UK)
 TCGI (ROW sales)
 TCGA (Americas sales)
 Tannoy Middle East

T: +44 (0) 1236 420199
 T: +45 8742 7000
 T: +1 (519) 745 1158
 T: +971 (04) 4401208

E: enquiries@tannoy.com
 E: info@tcgroup-international.com
 E: info@tcgroup-americas.com
 E: enquiries@tannoy.com

tannoy®.com



VX 12.2Q

TANNOY®

TECHNICAL SPECIFICATIONS

| | | | |
|--|---|--------------|--------|
| System | VX 12.2Q | | |
| Frequency Response (-3 dB) ⁽¹⁾ | 70 Hz - 25 kHz | | |
| Frequency Range (-10 dB) ⁽¹⁾ | 55 Hz - 30 kHz | | |
| System Sensitivity (1 W @ 1 m) ⁽²⁾ | | | |
| Passive - Full Range | 99 dB (1 W = 2.83 V for 8 ohms) | | |
| Biamp (LF) | 98 dB | | |
| Biamp (HF) | 102 dB | | |
| Dispersion (-6 dB) | 75 degrees (H) x 40 degrees (V) | | |
| Driver Complement | 1 x 305 mm (12") PowerDual with Q-Centric waveguide™ 1 x 305 mm (12") bass driver | | |
| Crossover | Passive 1.5 kHz <small>Product can be reconfigured for bi-amped operation.</small> | | |
| Directivity Factor (Q) | 13 (averaged 1kHz to 8kHz) | | |
| Directivity Index (DI) | 11.1 dB (averaged 1kHz to 8kHz) | | |
| Rated Maximum SPL ⁽²⁾ | | | |
| Passive - Full Range | 126 dB (average) 132 dB (peak) | | |
| Biamp (LF) | 123 dB (average) 129 dB (peak) | | |
| Biamp (HF) | 127 dB (average) 133 dB (peak) | | |
| Power Handling | Average | Programme | Peak |
| Passive - Full Range | 500 W | 1000 W | 2000 W |
| Biamp (LF) | 350 W | 700 W | 1400 W |
| Biamp (HF) | 350 W | 700 W | 1400 W |
| Recommended Amplifier Power | | | |
| Passive - Full Range | 1000 W @ 8 ohms | | |
| Biamp (LF) | 700 W @ 8 ohms | | |
| Biamp (HF) | 700 W @ 8 ohms | | |
| Nominal Impedance | | | |
| Passive - Full Range | 8 ohms | | |
| Biamp (LF) | 8 ohms | | |
| Biamp (HF) | 8 ohms | | |
| Distortion | | | |
| 10% Full Power (20 V) | 2nd Harmonic | 3rd Harmonic | |
| 250 Hz | 2.49% | 0.49% | |
| 1 kHz | 0.54% | 0.73% | |
| 10 kHz | 7.54% | 0.80% | |
| 1% Full Power (6.33 V) | 2nd Harmonic | 3rd Harmonic | |
| 250 Hz | 0.60% | 0.21% | |
| 1 kHz | 0.20% | 0.49% | |
| 10 kHz | 2.56% | 0.10% | |

Construction

| | |
|---------------------------|--|
| Enclosure | 57 litre, 15 mm (enclosure) and 18 mm (front) birch plywood, vented and internally braced. |
| Finish | Textured black or white paint, with custom colours on request. Powder-coated perforated steel grille, Airnet cloth behind. |
| Connectors | 2 x speakON NL 4MP and Barrier strip |
| Fittings | 8 x M10 Flying inserts (portrait or landscape mounting), 8 x M10 yoke bracket inserts, 2 x Integrip carrying handles, Blanking plate for optional VTH pole mount |
| Dimensions (HxWxD) | 780 x 370 x 380 mm (30.7 x 14.6 x 15") |
| Net weight | 33.5 kg (73.9 lbs) |
| Shipped weight | 36.5 kg (80.5 lbs) |
| Packed quantity | 1 |

Notes

(1) Average over stated bandwidth. Measured at 1 metre on axis in an anechoic chamber

(2) Unweighted pink noise input, measured at 1 metre in an anechoic chamber. A full range of measurements, performance data, and Ease™ Data can be downloaded at www.tannoy.com.

Tannoy is committed to a policy of continuous improvement through research and development. Though performance will equal or exceed published specifications, new materials or manufacturing processes could introduce variances. All figures are subject to change without notice. For critical applications, please confirm current specifications with your supplier or visit the Tannoy website at www.tannoy.com.

Ordering Information

| PART NUMBER | MODEL NAME | COLOUR | PACKED QUANTITY |
|-------------|------------|--------|-----------------|
| 8001 6380 | VX 12.2Q | BLACK | 1 |
| 8001 6381 | VX 12.2Q | WHITE | 1 |

Tannoy (Direct UK)
TCGI (ROW sales)
TCGA (Americas sales)
Tannoy Middle East

T: +44 (0) 1236 420199
T: +45 8742 7000
T: +1 (519) 745 1158
T: +971 (04) 4401208

E: enquiries@tannoy.com
E: info@tcgroup-international.com
E: info@tcgroup-americas.com
E: enquiries@tannoy.com

tannoy®.com



PERFORMANCE MEASUREMENTS

1 m on-axis Frequency Response

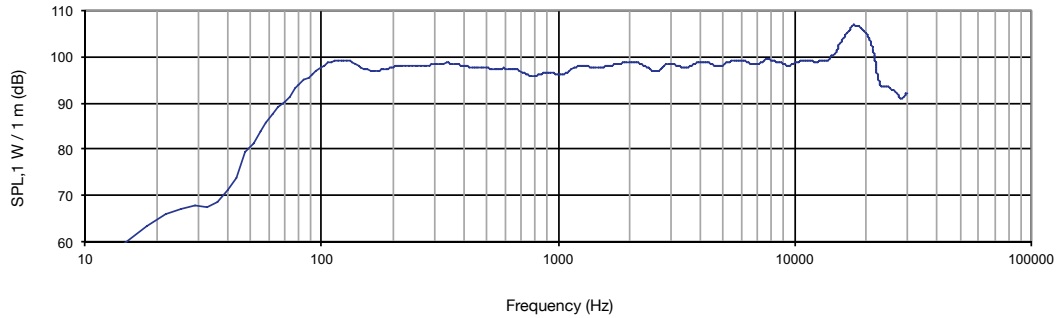

ANECHOIC FREQUENCY RESPONSE

Impedance vs frequency

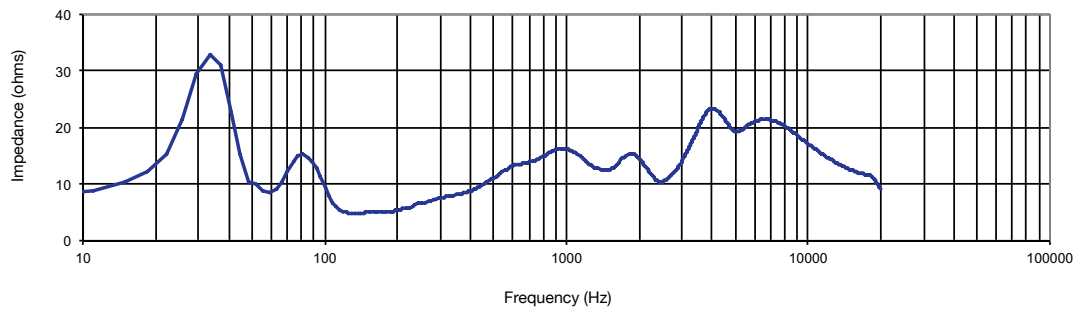

IMPEDANCE

Horizontal off-axis Response

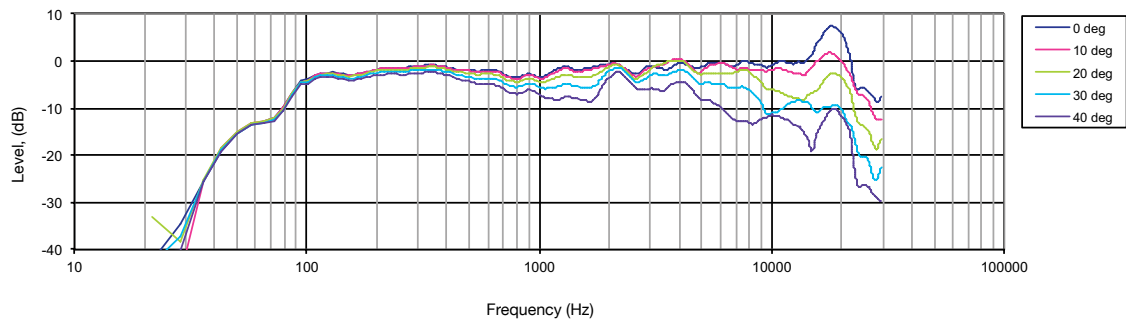

HORIZONTAL OFF-AXIS RESPONSE

Tannoy (Direct UK)
 TCGI (ROW sales)
 TCGA (Americas sales)
 Tannoy Middle East

T: +44 (0) 1236 420199
 T: +45 8742 7000
 T: +1 (519) 745 1158
 T: +971 (04) 4401208

E: enquiries@tannoy.com
 E: info@tcgroup-international.com
 E: info@tcgroup-americas.com
 E: enquiries@tannoy.com

tannoy®.com



PERFORMANCE MEASUREMENTS

Upper Vertical off-axis Frequency Response

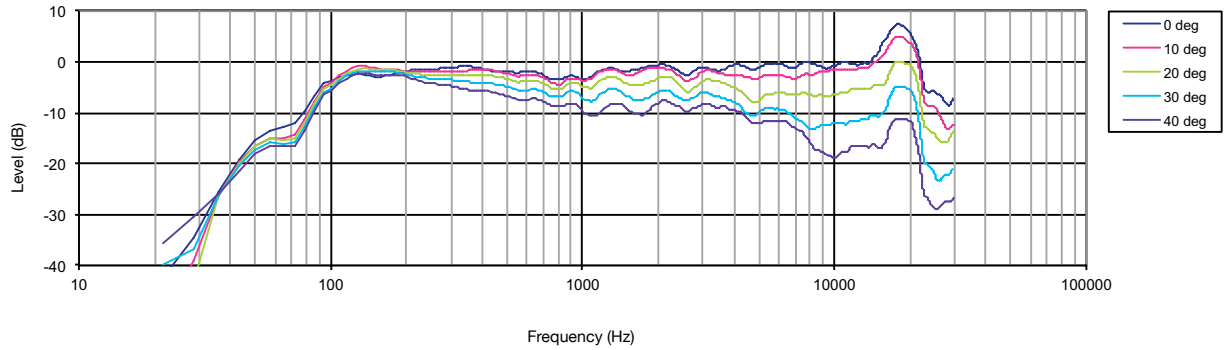

UPPER VERTICAL OFF-AXIS FREQUENCY RESPONSE

Lower Vertical off-axis Frequency Response

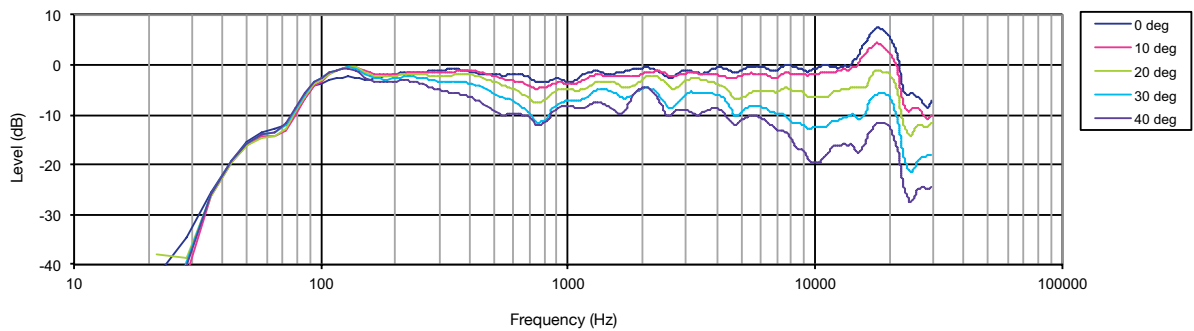

LOWER VERTICAL OFF-AXIS RESPONSE

Beamwidth vs Frequency

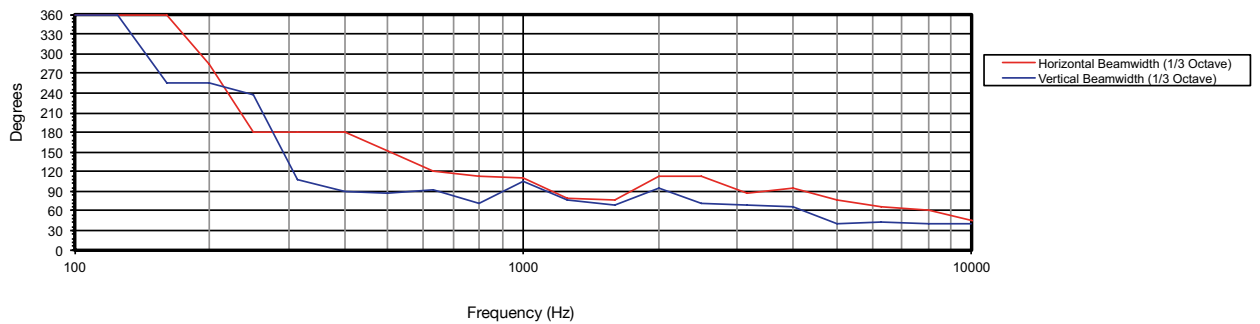

BEAMWIDTH

Tannoy (Direct UK)
 TCGI (ROW sales)
 TCGA (Americas sales)
 Tannoy Middle East

T: +44 (0) 1236 420199
 T: +45 8742 7000
 T: +1 (519) 745 1158
 T: +971 (04) 4401208

E: enquiries@tannoy.com
 E: info@tcgroup-international.com
 E: info@tcgroup-americas.com
 E: enquiries@tannoy.com

tannoy®.com



PERFORMANCE MEASUREMENTS

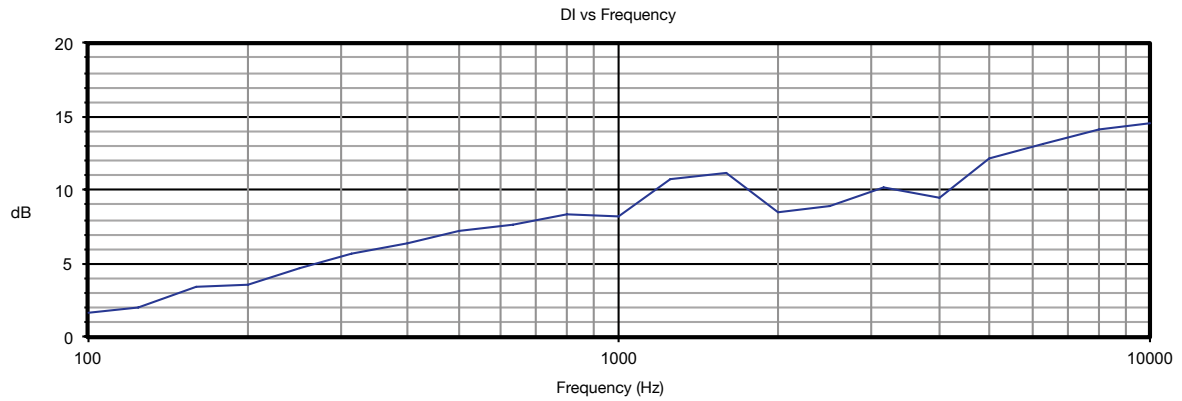

DIRECTIVITY INDEX (DI)

Tannoy (Direct UK)
TCGI (ROW sales)
TCGA (Americas sales)
Tannoy Middle East

T: +44 (0) 1236 420199
T: +45 8742 7000
T: +1 (519) 745 1158
T: +971 (04) 4401208

E: enquiries@tannoy.com
E: info@tcgroup-international.com
E: info@tcgroup-americas.com
E: enquiries@tannoy.com

tannoy.com



PERFORMANCE MEASUREMENTS POLAR PLOTS (1/3 OCTAVE)

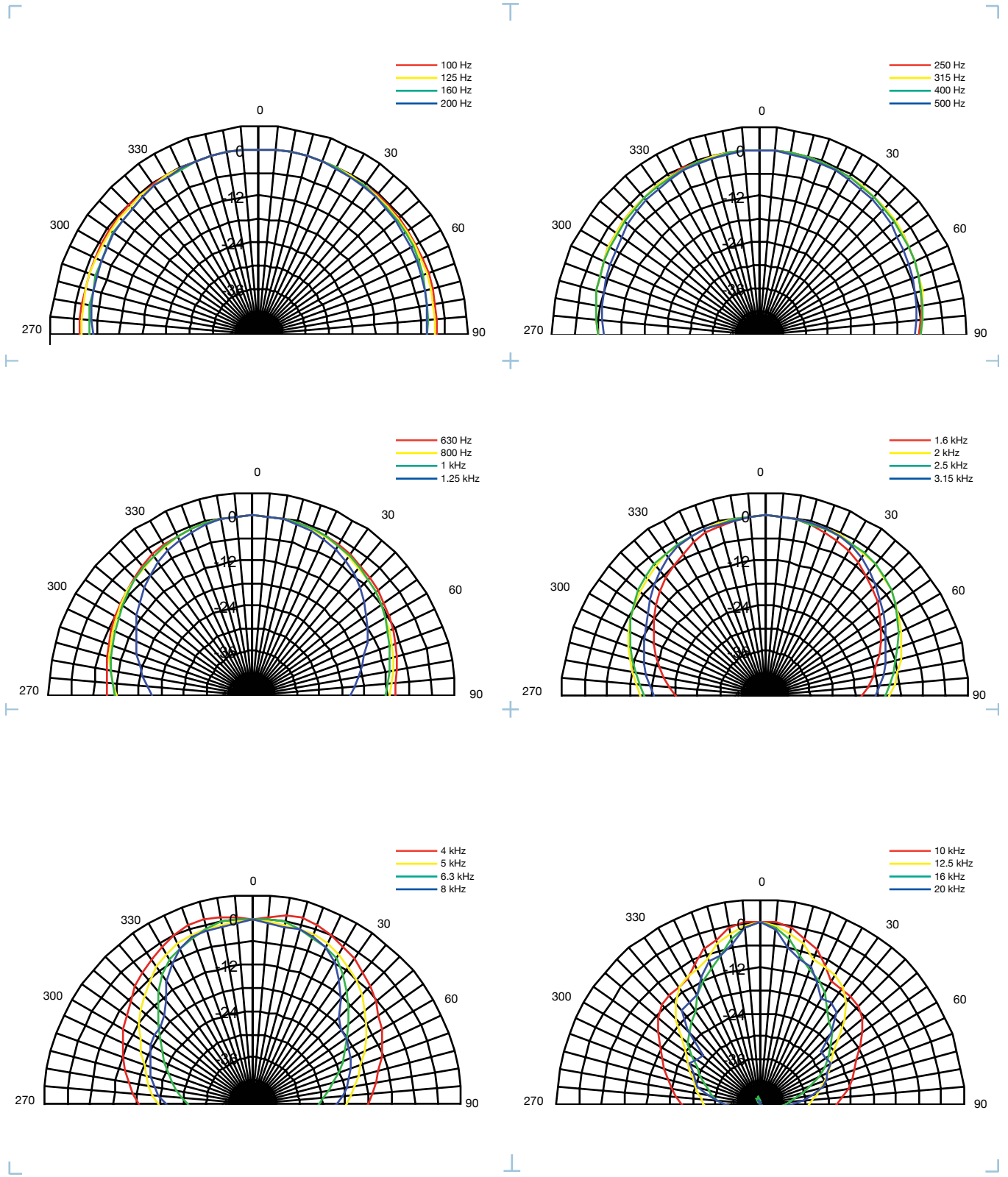

Tannoy (Direct UK)
 TCGI (ROW sales)
 TCGA (Americas sales)
 Tannoy Middle East

T: +44 (0) 1236 420199
 T: +45 8742 7000
 T: +1 (519) 745 1158
 T: +971 (04) 4401208

E: enquiries@tannoy.com
 E: info@tcgroup-international.com
 E: info@tcgroup-americas.com
 E: enquiries@tannoy.com

tannoy®.com



VX 12.2Q

TANNOY®

PERFORMANCE MEASUREMENTS POLAR PLOTS (1/3 OCTAVE)

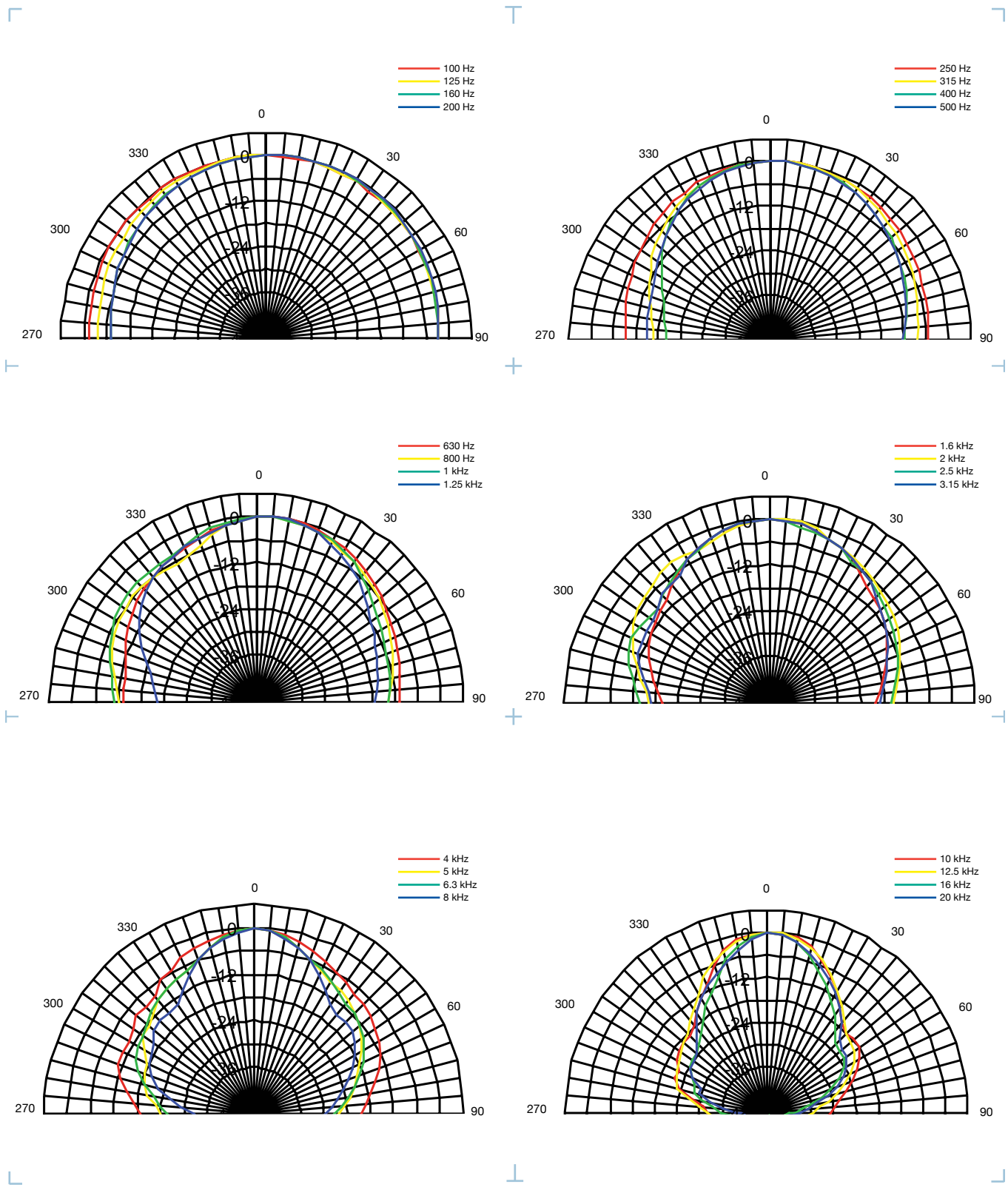

Tannoy (Direct UK)
 TCGI (ROW sales)
 TCGA (Americas sales)
 Tannoy Middle East

T: +44 (0) 1236 420199
 T: +45 8742 7000
 T: +1 (519) 745 1158
 T: +971 (04) 4401208

E: enquiries@tannoy.com
 E: info@tcgroup-international.com
 E: info@tcgroup-americas.com
 E: enquiries@tannoy.com

tannoy®.com



VX 12.2Q

TANNOY®

DIMENSIONAL SKETCHES

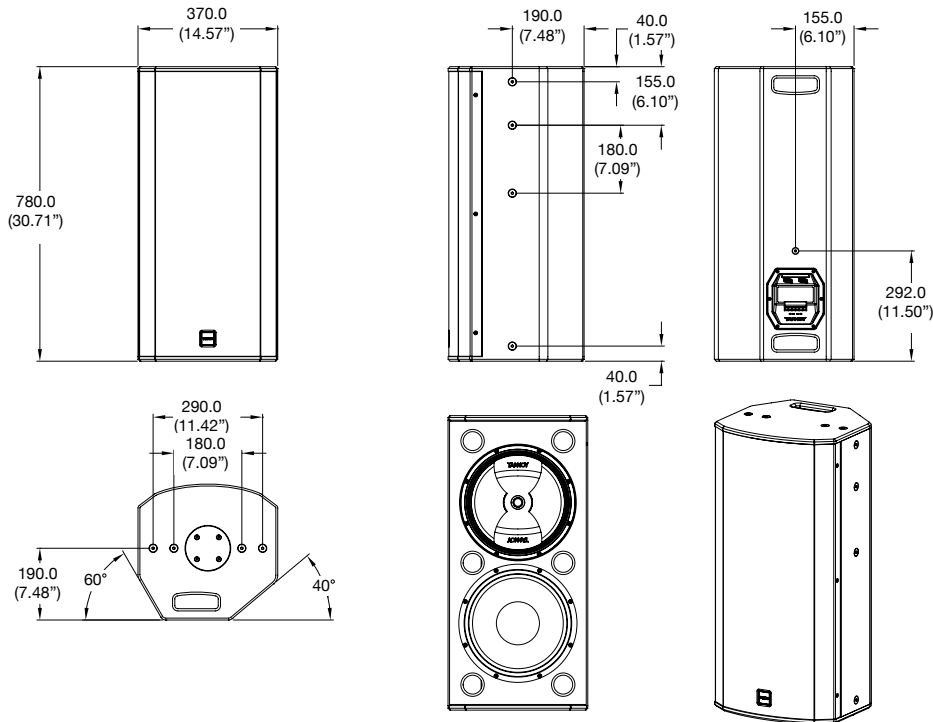

Architectural specifications

The loudspeaker shall consist of a 305 mm (12") full range, single point source PowerDual transducer with Q-Centric waveguide and a 305 mm (12") bass transducer. The low and the high frequency elements of the PowerDual transducer shall be combined by an internal passive crossover network operating at 1.5 kHz. An internal passive low-pass filter operating at 300 Hz shall limit midrange response of the bass transducer to prevent destructive cancellation. A user configurable internal switching arrangement on the input panel shall allow selection of full range passive or bi-amped two-way powering modes.

Performance of the loudspeaker, without any external electronic control, shall meet or exceed the following criteria: Frequency response in full range mode measured at 1 metre on axis with swept sine wave shall be 70 Hz – 25 kHz (-3 dB). In passive full range mode sensitivity mode shall be at least 99 dB (anechoic) 1 watt @ 1 metre and the loudspeaker shall be capable of producing a peak output level of 132 dB (anechoic) on axis at 1 metre. Dispersion shall be 75 degrees horizontal by 40 degrees vertical (-6 dB). The system shall have a nominal impedance of 8 ohms. Long-term power handling (EIA-426B) in passive full range mode shall be 500 watts and recommended amplifier power shall be 1000 watts.

The enclosure shall be an optimally tuned 57 litre vented enclosure of birch plywood construction. The enclosure shall be fitted with dual integral carrying handles, blanked off recess for optional pole-mount socket installation, 8 x M10 bracket inserts for landscape or portrait mounting, and 8 x M10 mounting points for yoke bracket inserts. The enclosure shall not exceed the following dimensions: 780 x 370 x 360 mm or 30.7 x 14.6 x 14.1" (H x W x D). The loudspeaker shall be the Tannoy VX 12.2Q.

Tannoy (Direct UK)
TCGI (ROW sales)
TCGA (Americas sales)
Tannoy Middle East

T: +44 (0) 1236 420199
T: +45 8742 7000
T: +1 (519) 745 1158
T: +971 (04) 4401208

E: enquiries@tannoy.com
E: info@tcgroup-international.com
E: info@tcgroup-americas.com
E: enquiries@tannoy.com

tannoy®.com