



Product Description

Conceived, engineered and built with precision in the United Kingdom, VX Series represents the latest evolution of Tannoy's core philosophies in professional loudspeaker design. VX 12Q is a new class of device that adds more versatility and enhanced performance capabilities. It provides a higher impact solution for medium scale sound reinforcement, affords flexibility in high-SPL applications such as bars and clubs, and also delivers controlled sound in portable PA applications.

The VX 12Q is built around a brand new, higher power handling 305 mm (12") version of Tannoy's exclusive point source, constant directivity PowerDual™ drive unit technology. By coupling PowerDual with the new Q-Centric Waveguide™ (QCW), VX 12Q brings best of both worlds – true point source performance combined with highly controlled 75 x 40 degree dispersion, resulting in less unwanted shading effects and optimized forward gain. The driver assembly can be rotated 90 degrees in the cabinet to allow for versatile mounting without compromise to coverage. For even higher power output, an internal connector switching arrangement on the input panel bypasses the internal passive crossover to allow bi-amplified operation in conjunction with an external active crossover.

Audio connection is via flush-mounted, recessed termination panel with both NL 4MP speakON and connector strip. An extensive range of high performance steel mounting hardware is available, custom designed for VX 12Q. This includes a yoke bracket for wall and ceiling location as well as eyebolt location points and a VTH top-hat for pole-mounting. Ergonomic Integrip™ recessed handles make one- and two-handed lift of the cabinet easier than ever for optimum portability.

All components are housed in a rugged birch plywood cabinet with aesthetically profiled edges and Airnet™-backed, powder-coated steel grille. The VX 12Q is available in black or white textured paint finish as standard, with matching grilles, and is also available in custom matched RAL colours as an option. A weather protected specification (WP) is also available as an option. This includes LINE-X cabinet outer-coating, internal sealing, and treated transducers with perforated Grade 316 stainless steel grilles. All steel hardware is upgraded to Grade 304 stainless steel, while all connector panel points are protected by a cover plate and weather-proof cable gland. Additional lead time applies to all non-standard specifications.

Features

- 305 mm (12") PowerDual full-range driver with QCW™ delivering best of both worlds – true point source combined with new horn design allowing tight vertical coverage
- Well defined 75 x 40 degree dispersion for optimum coverage and forward gainACO
- Peak output (passive full range) 129 dB, recommended amp power 700 W @ 8 ohms
- Integrip handles ergonomically integrated into top and bottom of cabinet
- Pole-mountable for optimum portability
- Exceptional sound and performance for a cabinet of this size
- Flush-mounted termination panel with NL4 SpeakON and barrier strip connections
- Available in black or white textured paint finish – custom colours optional
- Available in weather protected specification (optional)

Applications

- Theatres, Auditoria and Houses of Worship
- Medium scale PA.
- Bars and nightclubs
- Portable and installed corporate AV
- Theme parks and leisure venues
- Gymnasiums and small/medium sports arenas
- Cinemas

Tannoy (Direct UK)
TCGI (ROW sales)
TCGA (Americas sales)
Tannoy Middle East

T: +44 (0) 1236 420199
T: +45 8742 7000
T: +1 (519) 745 1158
T: +971 (04) 4401208

E: enquiries@tannoy.com
E: info@tcgroup-international.com
E: info@tcgroup-americas.com
E: enquiries@tannoy.com

tannoy®.com



TECHNICAL SPECIFICATIONS

System	VX 12Q		
Frequency Response (-3 dB) ⁽¹⁾	80 Hz - 25 kHz		
Frequency Range (-10 dB) ⁽¹⁾	60 Hz - 30 kHz		
System Sensitivity (1 W @1 m) ⁽²⁾			
Passive - Full Range	97 dB (1 W = 2.83 V for 8 ohms)		
Biamp (LF)	98 dB		
Biamp (HF)	108 dB		
Dispersion (-6 dB)	75 degrees (H) x 40 degrees (V)		
Driver Complement	1 x 305 mm (12") PowerDual with Q-Centric waveguide		
Crossover	Passive 1.5 kHz		
<small>Product can be reconfigured for bi-amped operation. Bi-amp system parameters in user manual</small>			
Directivity Factor (Q)	13 (averaged 1 kHz to 8 kHz)		
Directivity Index (DI)	11.1 dB (averaged 1 kHz to 8 kHz)		
Rated Maximum SPL ⁽²⁾			
Passive - Full Range	123 dB (average) 129 dB (peak)		
Biamp (LF)	124 dB (average) 130 dB (peak)		
Biamp (HF)	127 dB (average) 132 dB (peak)		
Power Handling	Average	Programme	Peak
Passive - Full Range	350 W	700 W	1400 W
Biamp (LF)	350 W	700 W	1400 W
Biamp (HF)	80 W	160 W	320 W
Recommended Amplifier Power			
Passive - Full Range	700 W @ 8 ohms		
Biamp (LF)	700 W @ 8 ohms		
Biamp (HF)	160 W @ 8 ohms		
Nominal Impedance			
Passive - Full Range	8 ohms		
Biamp (LF)	8 ohms		
Biamp (HF)	8 ohms		
Distortion			
10% Full Power (16.7 V)	2nd Harmonic	3rd Harmonic	
250 Hz	0.72%	0.17%	
1 kHz	0.57%	0.76%	
10 kHz	5.11%	0.41%	
1% Full Power (5.30 V)	2nd Harmonic	3rd Harmonic	
250 Hz	0.16%	0.19%	
1 kHz	0.18%	0.49%	
10 kHz	1.63%	0.08%	

Construction	
Enclosure	36.4 litre, 15 mm (enclosure) and 18 mm (front) birch plywood, vented and internally braced.
Finish	Textured black or white paint, with custom colours on request. Powder-coated perforated steel grille, Airnet cloth behind.
Connectors	2 x speakON NL 4MP and Barrier strip
Fittings	8 x M10 Flying inserts (portrait or landscape mounting), 8 x M10 yoke bracket inserts, 2 x Integrip carrying handles, Blanking plate for optional VTH pole mount, Fixings compatible with Powerdrive™ style brackets, 4 x M6 inserts
Dimensions (HxWxD)	490 x 370 x 380 mm (19.3 x 14.6 x 15")
Net weight	21 kg (46.3 lbs)
Shipped weight	23 kg (50.7 lbs)
Packed quantity	1

Notes

(1) Average over stated bandwidth. Measured at 1 metre on axis in an anechoic chamber

(2) Unweighted pink noise input, measured at 1 metre in an anechoic chamber. A full range of measurements, performance data, and Ease™ Data can be downloaded at www.tannoy.com.

Tannoy is committed to a policy of continuous improvement through research and development. Though performance will equal or exceed published specifications, new materials or manufacturing processes could introduce variances. All figures are subject to change without notice. For critical applications, please confirm current specifications with your supplier or visit the Tannoy website at www.tannoy.com.

Ordering Information

PART NUMBER	MODEL NAME	COLOUR	PACKED QUANTITY
8001 6370	VX 12Q	BLACK	1
8001 6371	VX 12Q	WHITE	1

Tannoy (Direct UK)
TCGI (ROW sales)
TCGA (Americas sales)
Tannoy Middle East

T: +44 (0) 1236 420199
T: +45 8742 7000
T: +1 (519) 745 1158
T: +971 (04) 4401208

E: enquiries@tannoy.com
E: info@tcgroup-international.com
E: info@tcgroup-americas.com
E: enquiries@tannoy.com

tannoy.com



PERFORMANCE MEASUREMENTS

1 m on-axis Frequency Response

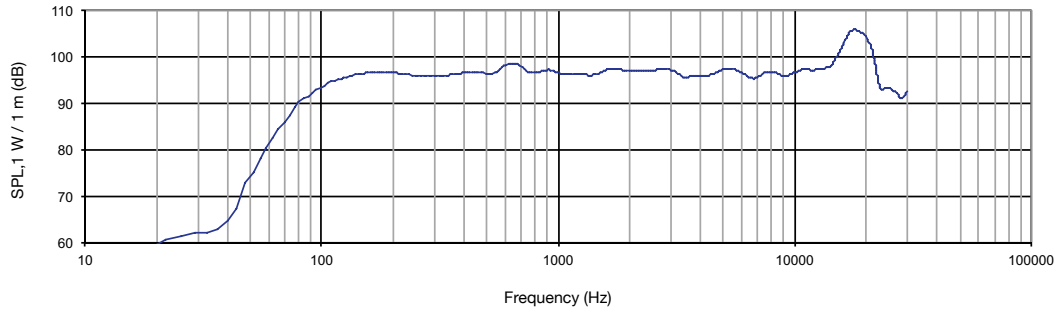

ANECHOIC FREQUENCY RESPONSE

Impedance vs frequency

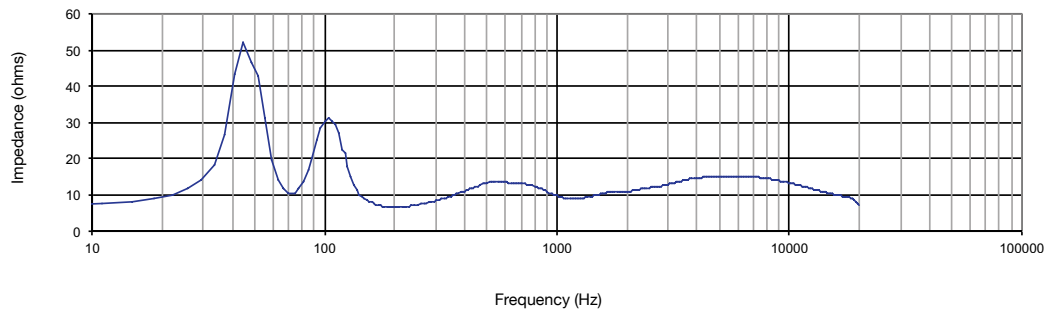

IMPEDANCE

Horizontal off-Axis Response

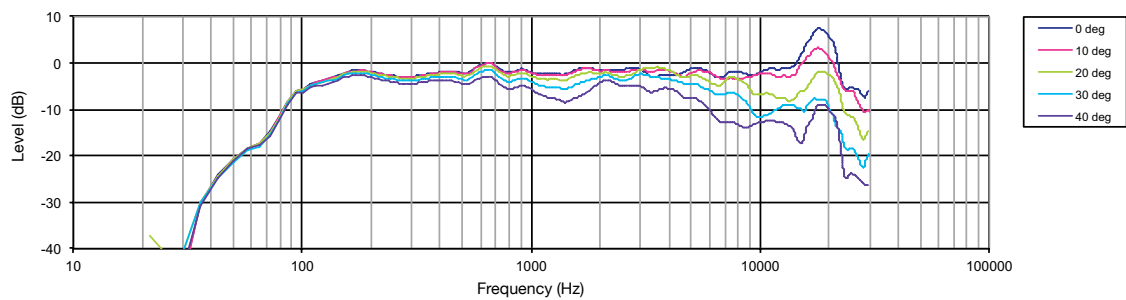

HORIZONTAL OFF-AXIS RESPONSE

Tannoy (Direct UK)
 TCGI (ROW sales)
 TCGA (Americas sales)
 Tannoy Middle East

T: +44 (0) 1236 420199
 T: +45 8742 7000
 T: +1 (519) 745 1158
 T: +971 (04) 4401208

E: enquiries@tannoy.com
 E: info@tcgroup-international.com
 E: info@tcgroup-americas.com
 E: enquiries@tannoy.com

tannoy®.com



PERFORMANCE MEASUREMENTS

Vertical off-axis Frequency Response

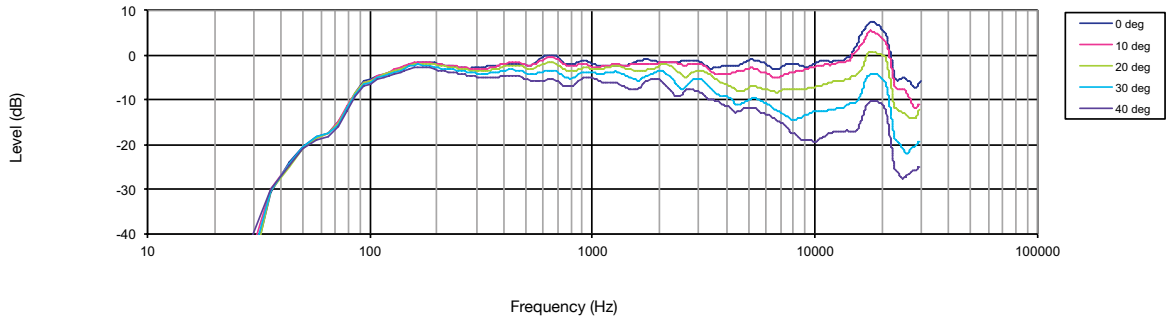

VERTICAL OFF-AXIS FREQUENCY RESPONSE

Beamwidth vs Frequency

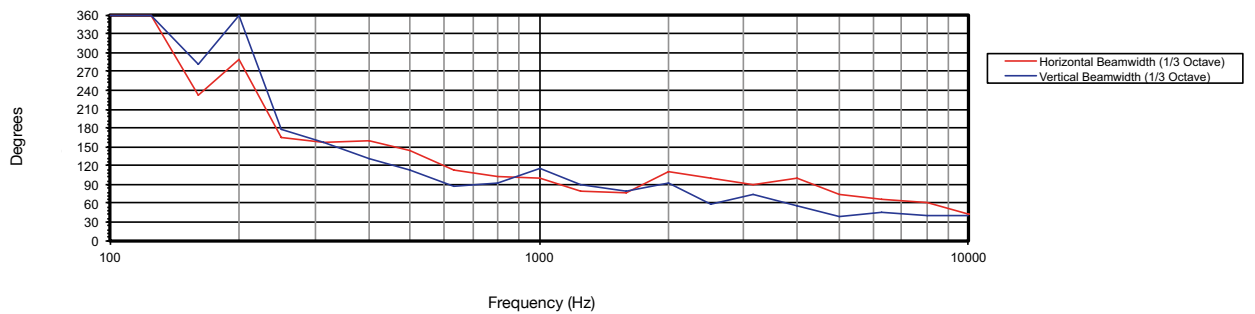

BEAMWIDTH

DI vs Frequency

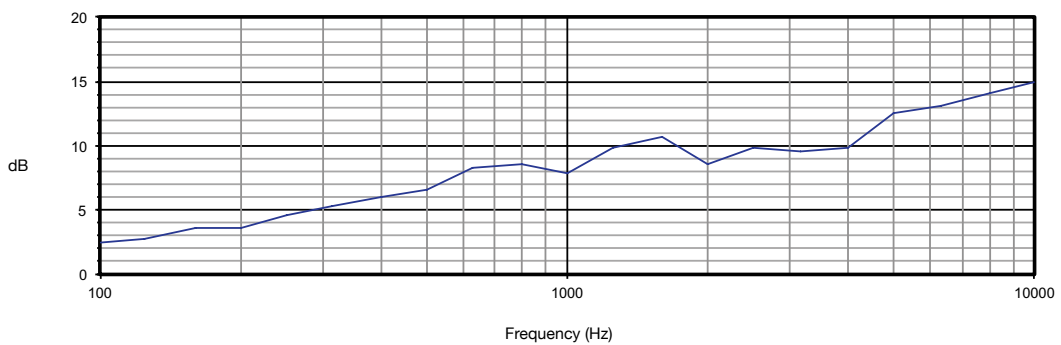

DIRECTIVITY INDEX (DI)

Tannoy (Direct UK)
 TCGI (ROW sales)
 TCGA (Americas sales)
 Tannoy Middle East

T: +44 (0) 1236 420199
 T: +45 8742 7000
 T: +1 (519) 745 1158
 T: +971 (04) 4401208

E: enquiries@tannoy.com
 E: info@tcgroup-international.com
 E: info@tcgroup-americas.com
 E: enquiries@tannoy.com



PERFORMANCE MEASUREMENTS POLAR PLOTS (1/3 OCTAVE)

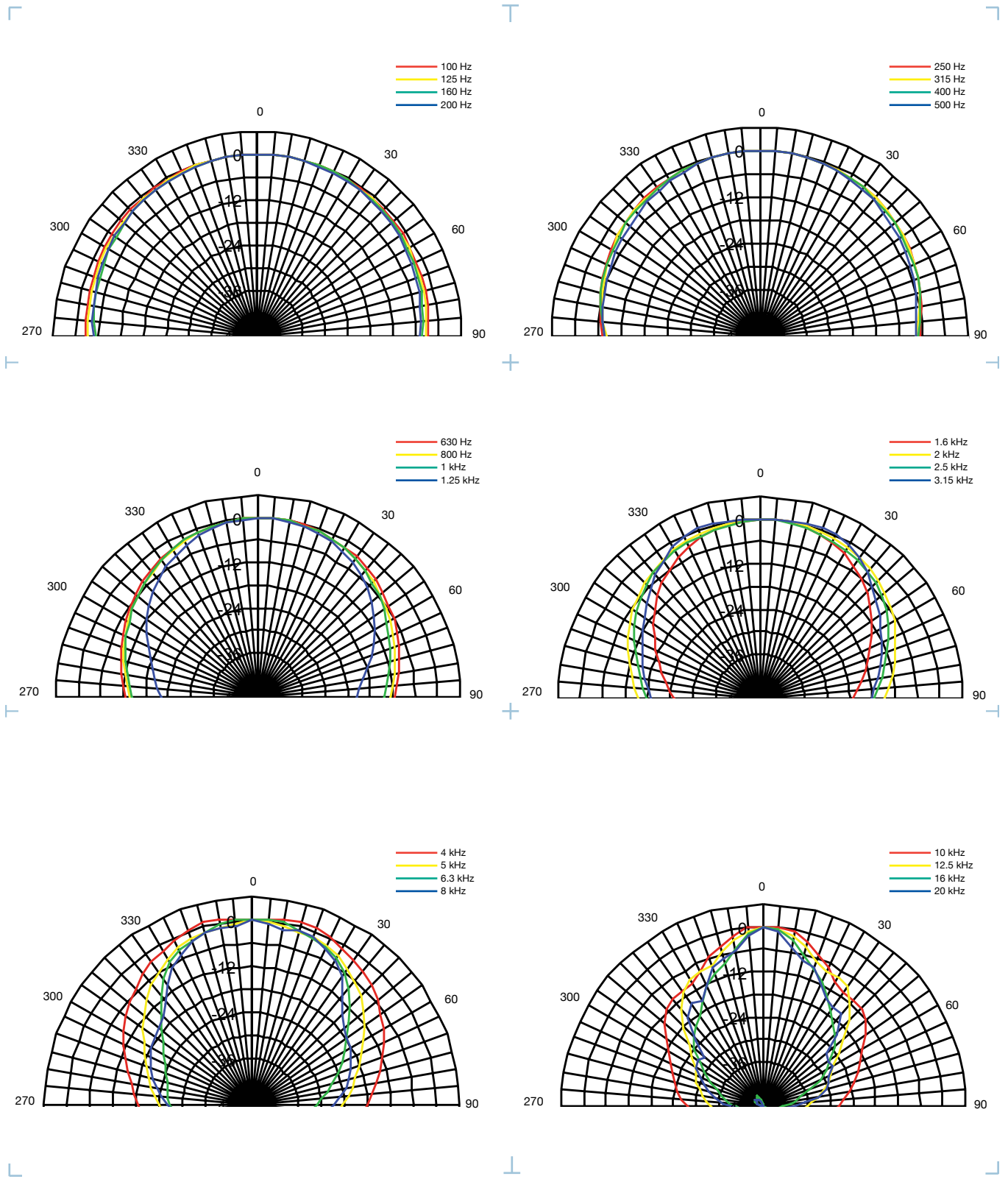

Tannoy (Direct UK)
 TCGI (ROW sales)
 TCGA (Americas sales)
 Tannoy Middle East

T: +44 (0) 1236 420199
 T: +45 8742 7000
 T: +1 (519) 745 1158
 T: +971 (04) 4401208

E: enquiries@tannoy.com
 E: info@tcgroup-international.com
 E: info@tcgroup-americas.com
 E: enquiries@tannoy.com

tannoy®.com



PERFORMANCE MEASUREMENTS POLAR PLOTS (1/3 OCTAVE)

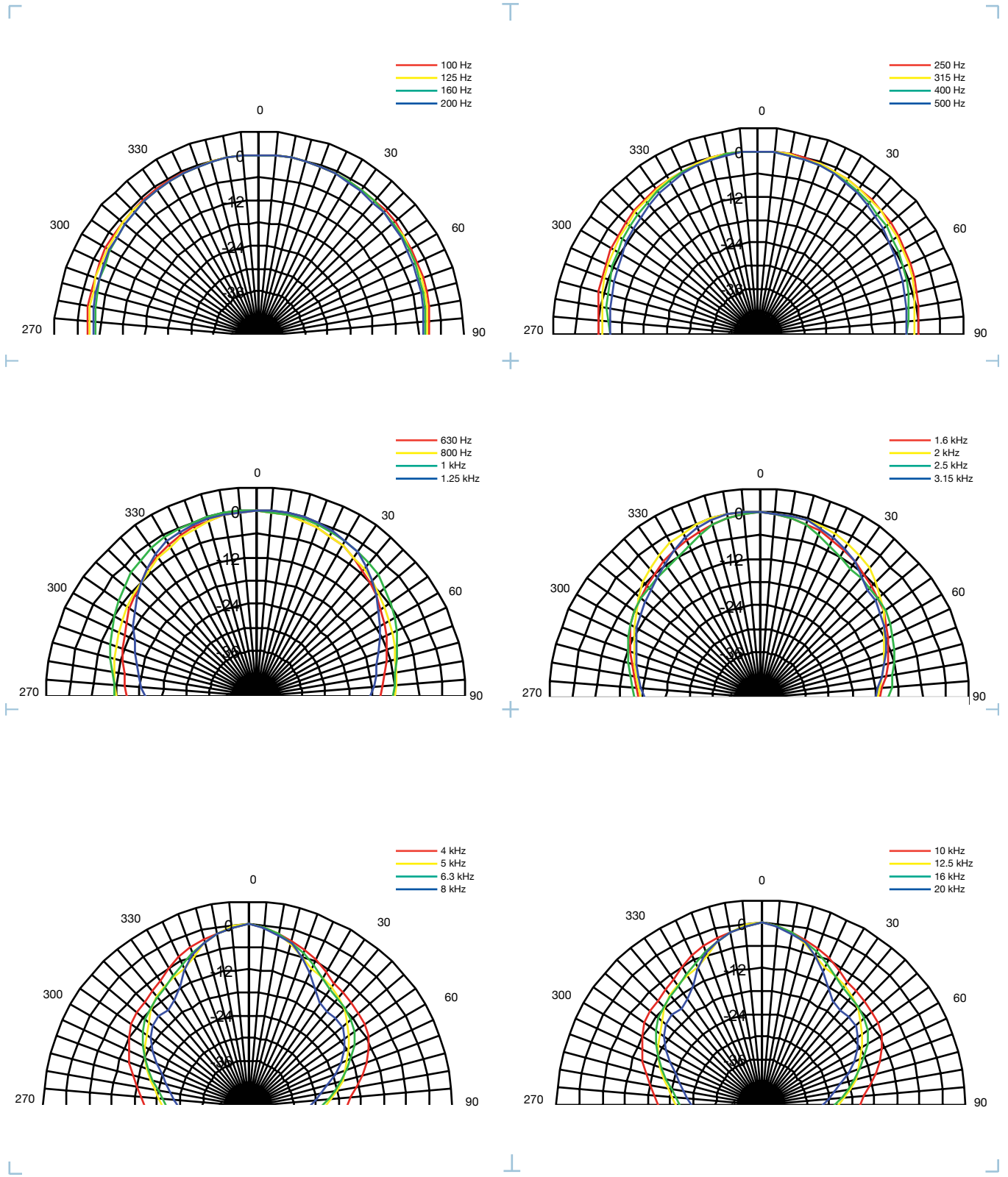

Tannoy (Direct UK)
 TCGI (ROW sales)
 TCGA (Americas sales)
 Tannoy Middle East

T: +44 (0) 1236 420199
 T: +45 8742 7000
 T: +1 (519) 745 1158
 T: +971 (04) 4401208

E: enquiries@tannoy.com
 E: info@tcgroup-international.com
 E: info@tcgroup-americas.com
 E: enquiries@tannoy.com

tannoy®.com



VX 12Q

TANNOY®

DIMENSIONAL SKETCHES

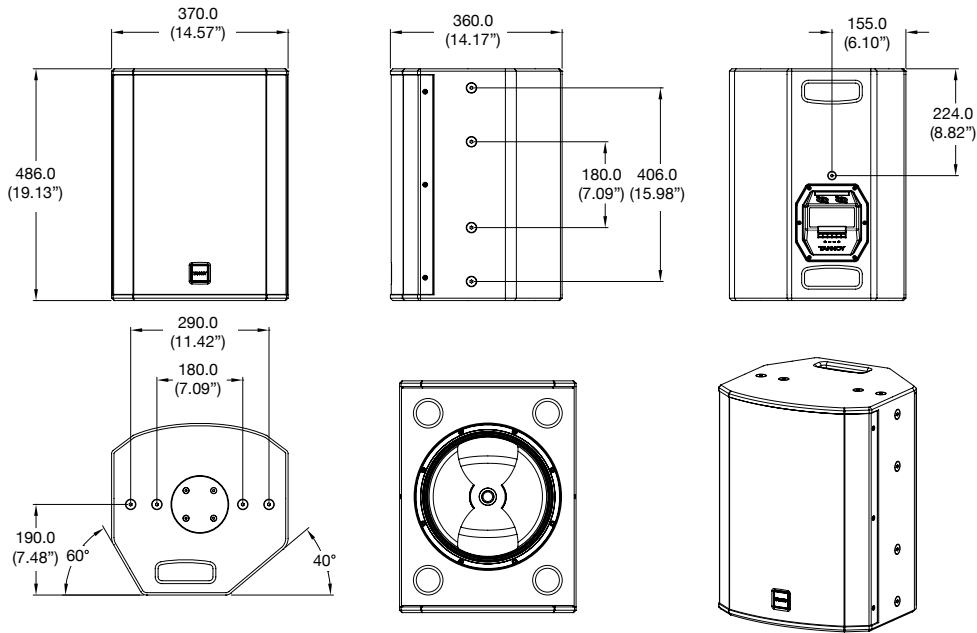

Tannoy (Direct UK)
 TCGI (ROW sales)
 TCGA (Americas sales)
 Tannoy Middle East

T: +44 (0) 1236 420199
 T: +45 8742 7000
 T: +1 (519) 745 1158
 T: +971 (04) 4401208

E: enquiries@tannoy.com
 E: info@tcgroup-international.com
 E: info@tcgroup-americas.com
 E: enquiries@tannoy.com

tannoy®.com



Architectural specifications

The loudspeaker shall consist of a 305 mm (12") full range, single point source PowerDual transducer with Q-Centric waveguide. The low and the high frequency elements shall be combined by an internal passive crossover network operating at 1.5 kHz. A user configurable internal switching arrangement on the input panel shall allow selection of full range passive or bi-amped two-way powering modes.

Performance of the loudspeaker, without any external electronic control, shall meet or exceed the following criteria: Frequency response in full range mode measured at 1 metre on axis with swept sine wave shall be 80 Hz – 25 kHz (-3 dB). In passive full range mode sensitivity mode shall be at least 97 dB (anechoic) 1 watt @ 1 metre and the loudspeaker shall be capable of producing a peak output level of 129 dB (anechoic) on axis at 1 metre. Dispersion shall be 75 degrees horizontal x 40 degrees vertical (6 dB). The system shall have a nominal impedance of 8 ohms. Long-term power handling (EIA-426B) in passive full range mode shall be 350 watts and recommended amplifier power shall be 700 watts.

The enclosure shall be an optimally tuned 36.4 litre vented enclosure of birch plywood construction. The enclosure shall be fitted with dual integral carrying handles, blanked off recess for optional pole-mount socket installation, 8 x M10 bracket inserts for landscape or portrait mounting, and 8 x M10 mounting points for yoke bracket inserts. The enclosure shall not exceed the following dimensions: 486 x 370 x 360 mm or 19.1 x 14.6 x 14.1" (H x W x D). The loudspeaker shall be the Tannoy VX 12Q.