



Product Description

Conceived, engineered and built with precision in the United Kingdom, VX Series represents the latest evolution of Tannoy's core philosophies in professional loudspeaker design. VX 15HP builds on the foundation of the highly successful V15 HP, justly renowned worldwide for its exceptional performance and versatility. Now incorporating significant upgrades, the successor VX 15HP offers a compact yet punchy and sonically vibrant solution for medium-scale live reinforcement as well as for demanding BGM systems in – for example – fashion retail outlets, bars, and small clubs. The VX 15HP is acoustically matched to the wider range of VX Series models, affording maximum flexibility within much larger installations.

The VX 15HP is built around a single 380 mm (15") PowerDual™ driver mounted within a compact, rugged birch plywood cabinet with aesthetically profiled edges and an Airnet™-backed, powder-coated steel grille. The latest high power-handling version of Tannoy's exclusive point source, constant directivity PowerDual technology ensures high power output with high sensitivity and exceptional efficiency. More than 60 years of research into point source driver technology allows this unique configuration to deliver exceptionally smooth beam-width characteristics resulting in an even coverage pattern at all frequencies aiding predictable system design. For even higher power output, an internal connector switching arrangement on the input panel bypasses the internal passive crossover to allow bi-amplified operation in conjunction with an external active crossover. Symmetrical dispersion characteristics enhance speaker placement flexibility, allowing vertical or horizontal mounting of single or multi-cabinet arrays without any compromise in sound quality.

Audio connection is via barrier strip or NL 4MP speakON located on the flush-mounted termination panel. An extensive range of high performance steel mounting hardware, custom designed for VX 15HP, includes a yoke bracket for wall and ceiling location, eyebolt location points, and a VTH top-hat for pole-mounting. For absolute security and installers' peace of mind, all hardware has been tested and certified to guarantee greater than 5:1 safety ratio.

The VX 15HP is available in black or white textured paint finish as standard (with matching grilles), and is also available in custom matched RAL colours as an option. The optional weather protected specification (WP) includes LINE-X cabinet outer-coating, internal sealing, and treated transducers with perforated Grade 316 stainless steel grilles. All steel hardware is upgraded to Grade 304 stainless steel, while all connector panel points are protected by a cover plate and weather-proof cable gland. Additional ordering lead time applies to all non-standard specifications.

Features

- 380 mm (15") PowerDual full-range driver
- Well defined 75 degree dispersion for optimum coverage and forward gain
- Peak output (passive full range mode) 131 dB SPL @ 1 m, recommended amp power 800 W @ 8 ohms
- Versatile mounting via optional custom designed hardware
- Integrip™ handles ergonomically integrated on top and bottom of cabinet
- Pole-mountable for optimum portability
- Exceptional sound and performance in a highly compact cabinet
- Rugged birch plywood enclosure
- Available in black or white textured paint finish – custom colours optional
- Available in weather protected specification (optional)
- Engineered and built in UK

Applications

- Theatres, Auditoria and Houses of Worship
- Medium scale PA.
- Bars and nightclubs
- Portable and installed corporate AV
- Theme parks and leisure venues
- Gymnasiums and small/medium sports arenas
- Cinemas

Tannoy (Direct UK)
TCGI (ROW sales)
TCGA (Americas sales)
Tannoy Middle East

T: +44 (0) 1236 420199
T: +45 8742 7000
T: +1 (519) 745 1158
T: +971 (04) 4401208

E: enquiries@tannoy.com
E: info@tcgroup-international.com
E: info@tcgroup-americas.com
E: enquiries@tannoy.com

tannoy®.com



VX 15HP

TANNOY®

TECHNICAL SPECIFICATIONS

System	VX 15HP		
Frequency Response (-3 dB) ⁽¹⁾	70 Hz - 25 kHz		
Frequency Range (-10 dB) ⁽¹⁾	58 Hz - 30 kHz		
System Sensitivity (1 W @ 1 m) ⁽²⁾			
Passive - Full Range	99 dB (1 W = 2.83 V for 8 ohms)		
Biamp (LF)	100 dB		
Biamp (HF)	106 dB		
Dispersion (-6 dB)	75 degrees		
Driver Complement	1 x 380 mm (15") PowerDual		
Crossover	Passive 1.3 kHz		
<small>Product can be reconfigured for bi-amped operation. Bi-amp system parameters in user manual</small>			
Directivity Factor (Q)	9.7 (averaged 1 kHz to 8 kHz)		
Directivity Index (DI)	9.9 dB (averaged 1 kHz to 8 kHz)		
Rated Maximum SPL ⁽²⁾			
Passive - Full Range	125 dB (average)	131 dB (peak)	
Biamp (LF)	126 dB (average)	132 dB (peak)	
Biamp (HF)	125 dB (average)	131 dB (peak)	
Power Handling	Average	Programme	Peak
Passive - Full Range	400 W	800 W	1600 W
Biamp (LF)	400 W	800 W	1600 W
Biamp (HF)	80 W	160 W	320 W
Recommended Amplifier Power			
Passive - Full Range	800 W @ 8 ohms		
Biamp (LF)	800 W @ 8 ohms		
Biamp (HF)	160 W @ 8 ohms		
Nominal Impedance			
Passive - Full Range	8 ohms		
Biamp (LF)	8 ohms		
Biamp (HF)	8 ohms		
Distortion			
10% Full Power (17.9 V)	2nd Harmonic	3rd Harmonic	
250 Hz	1%	0.56%	
1 kHz	1.4%	1%	
10 kHz	3.9%	1.8%	
1% Full Power (5.6 V)	2nd Harmonic	3rd Harmonic	
250 Hz	0.31%	0.45%	
1 kHz	0.45%	0.79%	
10 kHz	3.16%	0.32%	

Construction	
Enclosure	54.9 litre, 18 mm birch plywood, vented and internally braced.
Finish	Textured black or white paint, with custom colours on request. Powder-coated perforated steel grille, Airnet cloth behind.
Connectors	2 x speakON NL 4MP and Barrier strip
Fittings	8 x M10 Flying inserts (portrait or landscape mounting), 8 x M10 yoke bracket inserts, 2 x Integrip carrying handles, Blanking plate for optional VTH pole mount, Fixings compatible with Powerdrive™ style brackets, 4 x M6 inserts
Dimensions (HxWxD)	590 x 450 x 420 mm (23.2 x 17.7 x 16.5")
Net weight	26.5 kg (58.4 lbs)
Shipped weight	29.5 kg (65 lbs)
Packed quantity	1

Notes

(1) Average over stated bandwidth. Measured at 1 metre on axis in an anechoic chamber

(2) Unweighted pink noise input, measured at 1 metre in an anechoic chamber. A full range of measurements, performance data, and Ease™ Data can be downloaded at www.tannoy.com.

Tannoy is committed to a policy of continuous improvement through research and development. Though performance will equal or exceed published specifications, new materials or manufacturing processes could introduce variances. All figures are subject to change without notice. For critical applications, please confirm current specifications with your supplier or visit the Tannoy website at www.tannoy.com.

Ordering Information

PART NUMBER	MODEL NAME	COLOUR	PACKED QUANTITY
8001 6390	VX 15HP	BLACK	1
8001 6391	VX 15HP	WHITE	1

Tannoy (Direct UK)
TCGI (ROW sales)
TCGA (Americas sales)
Tannoy Middle East

T: +44 (0) 1236 420199
T: +45 8742 7000
T: +1 (519) 745 1158
T: +971 (04) 4401208

E: enquiries@tannoy.com
E: info@tcgroup-international.com
E: info@tcgroup-americas.com
E: enquiries@tannoy.com

tannoy®.com



PERFORMANCE MEASUREMENTS

1 m on-axis Frequency Response

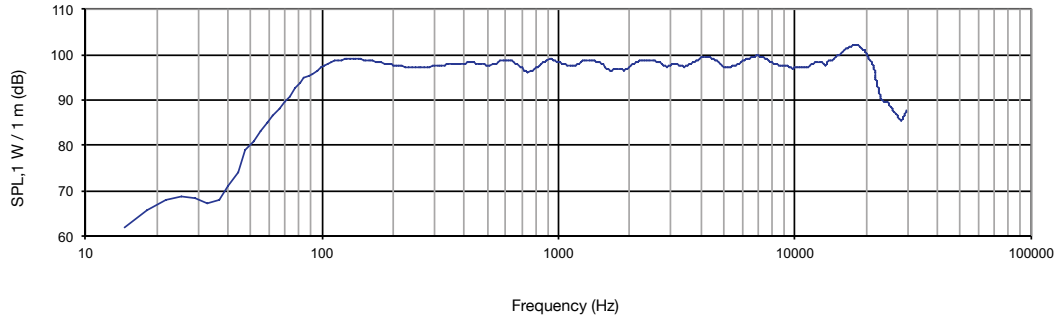

ANECHOIC FREQUENCY RESPONSE

Impedance vs frequency

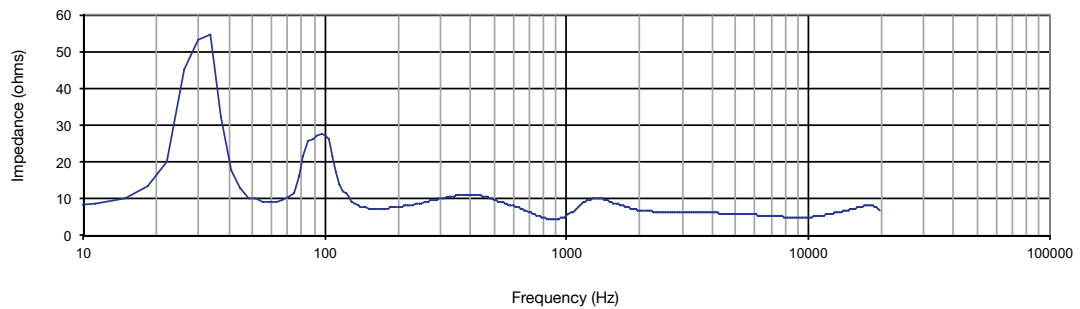

IMPEDANCE

Horizontal off-axis Frequency Response

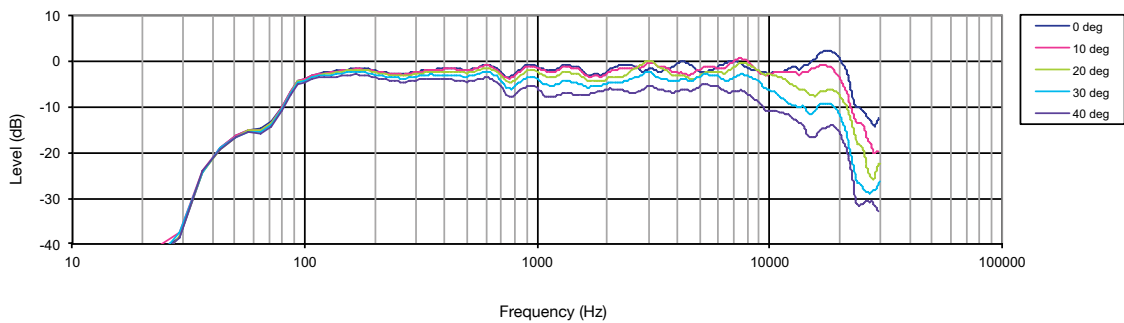

HORIZONTAL OFF-AXIS RESPONSE

Tannoy (Direct UK)
 TCGI (ROW sales)
 TCGA (Americas sales)
 Tannoy Middle East

T: +44 (0) 1236 420199
 T: +45 8742 7000
 T: +1 (519) 745 1158
 T: +971 (04) 4401208

E: enquiries@tannoy.com
 E: info@tcgroup-international.com
 E: info@tcgroup-americas.com
 E: enquiries@tannoy.com

tannoy®.com



PERFORMANCE MEASUREMENTS

Beamwidth vs Frequency

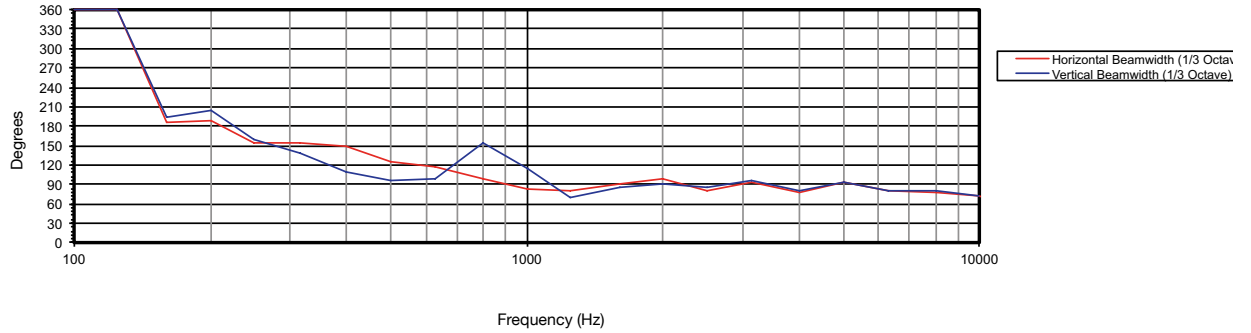

BEAMWIDTH

DI vs Frequency

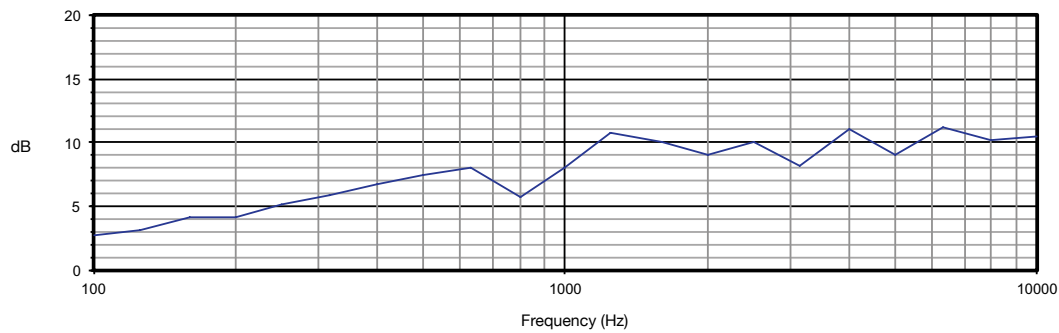

DIRECTIVITY INDEX (DI)

Tannoy (Direct UK)
 TCGI (ROW sales)
 TCGA (Americas sales)
 Tannoy Middle East

T: +44 (0) 1236 420199
 T: +45 8742 7000
 T: +1 (519) 745 1158
 T: +971 (04) 4401208

E: enquiries@tannoy.com
 E: info@tcgroup-international.com
 E: info@tcgroup-americas.com
 E: enquiries@tannoy.com

tannoy®.com



VX 15HP

TANNOY®

PERFORMANCE MEASUREMENTS POLAR PLOTS (1/3 OCTAVE)

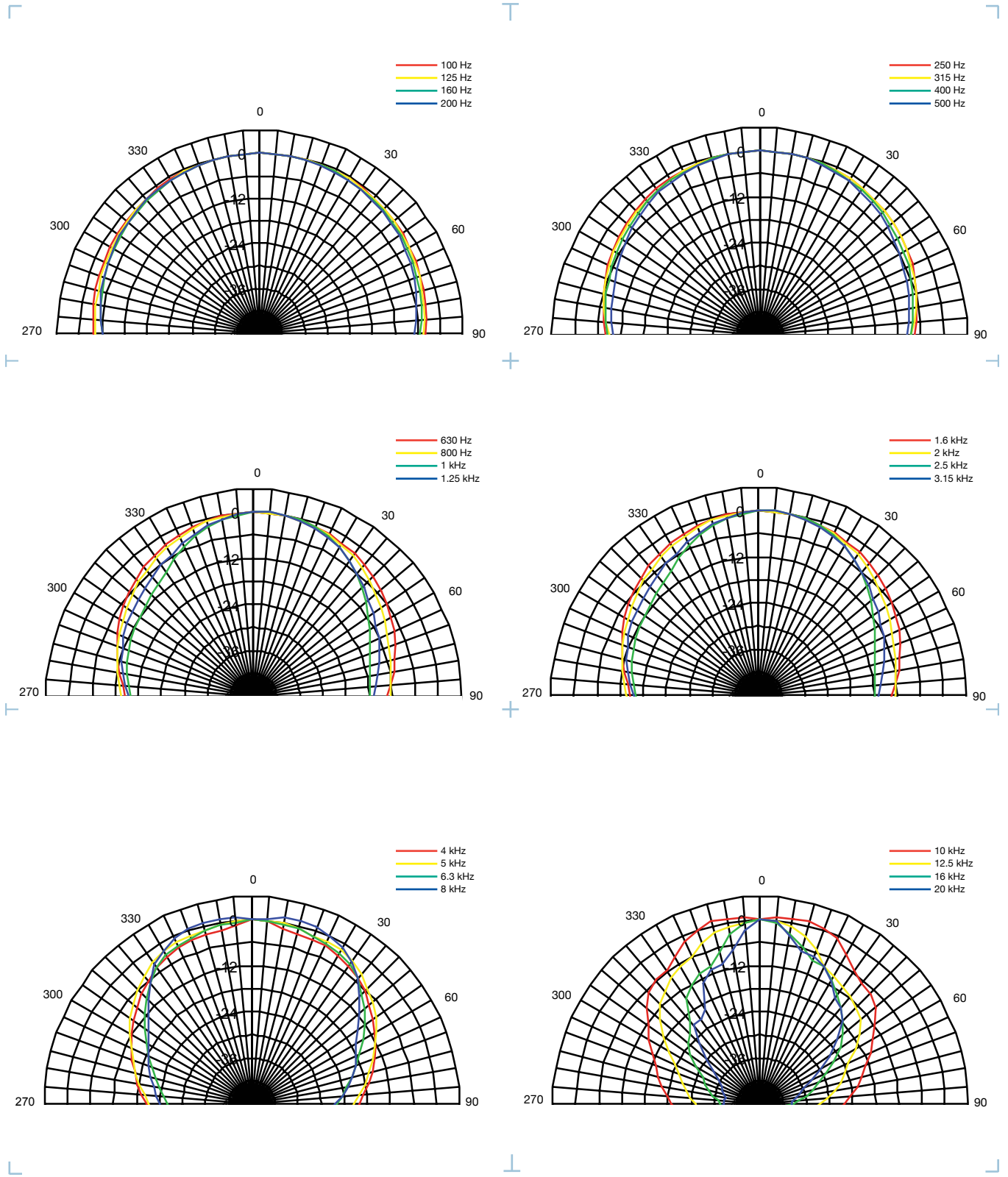

Tannoy (Direct UK)
 TCGI (ROW sales)
 TCGA (Americas sales)
 Tannoy Middle East

T: +44 (0) 1236 420199
 T: +45 8742 7000
 T: +1 (519) 745 1158
 T: +971 (04) 4401208

E: enquiries@tannoy.com
 E: info@tcgroup-international.com
 E: info@tcgroup-americas.com
 E: enquiries@tannoy.com

tannoy®.com



PERFORMANCE MEASUREMENTS POLAR PLOTS (1/3 OCTAVE)

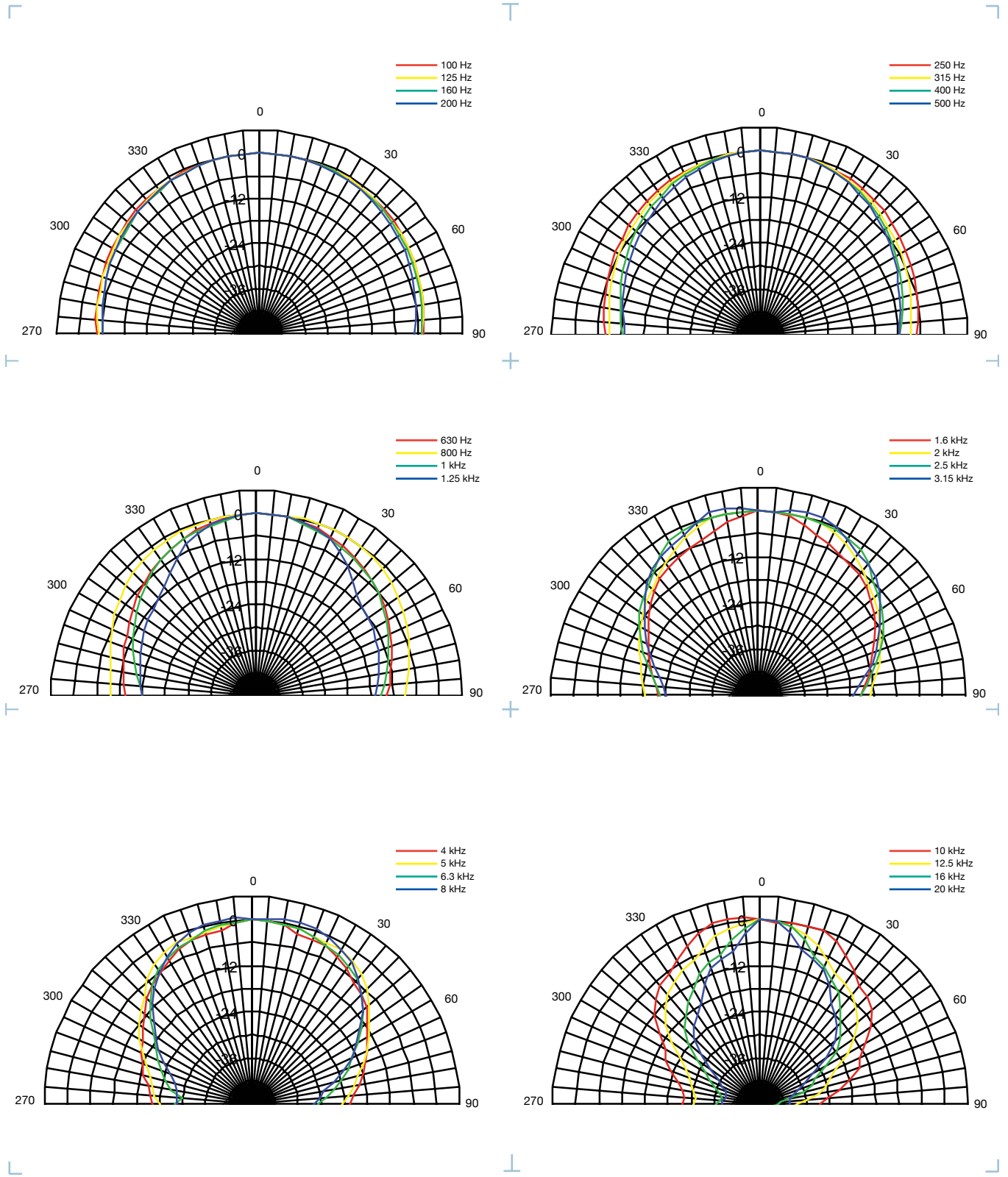

Tannoy (Direct UK)
 TCGI (ROW sales)
 TCGA (Americas sales)
 Tannoy Middle East

T: +44 (0) 1236 420199
 T: +45 8742 7000
 T: +1 (519) 745 1158
 T: +971 (04) 4401208

E: enquiries@tannoy.com
 E: info@tcgroup-international.com
 E: info@tcgroup-americas.com
 E: enquiries@tannoy.com

tannoy®.com



VX 15HP

TANNOY®

DIMENSIONAL SKETCHES

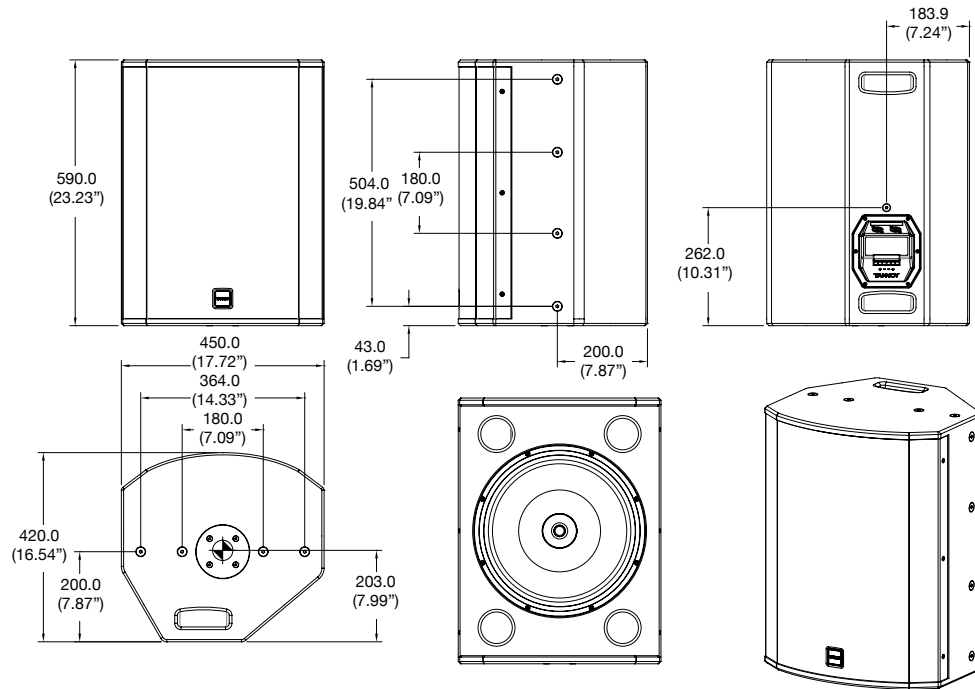

Tannoy (Direct UK)
 TCGI (ROW sales)
 TCGA (Americas sales)
 Tannoy Middle East

T: +44 (0) 1236 420199
 T: +45 8742 7000
 T: +1 (519) 745 1158
 T: +971 (04) 4401208

E: enquiries@tannoy.com
 E: info@tcgroup-international.com
 E: info@tcgroup-americas.com
 E: enquiries@tannoy.com

tannoy®.com



Architectural specifications

The loudspeaker shall consist of a 380 mm (15") full range, single point source PowerDual transducer. The low and the high frequency elements shall be combined by an internal passive crossover network operating at 1.3 kHz. A user configurable internal switching arrangement on the input panel shall allow selection of full range passive or bi-amped two-way powering modes.

Performance of the loudspeaker, without any external electronic control, shall meet or exceed the following criteria: Frequency response in full range mode measured at 1 metre on axis with swept sine wave shall be 70 Hz – 25 kHz (-3 dB). In passive full range mode sensitivity mode shall be at least 99 dB (anechoic) 1 watt @ 1 metre and the loudspeaker shall be capable of producing a peak output level of 131 dB (anechoic) on axis at 1 metre. Dispersion shall be 75 degrees conical (-6 dB). The system shall have a nominal impedance of 8 ohms. Long-term power handling (EIA-426B) in passive full range mode shall be 400 watts and recommended amplifier power shall be 800 watts.

The enclosure shall be an optimally tuned 54.9 litre vented enclosure of birch plywood construction. The enclosure shall be fitted with dual integral carrying handles, blanked off recess for optional pole-mount socket installation, 8 x M10 bracket inserts for landscape or portrait mounting, and 8 x M10 mounting points for yoke bracket inserts. The enclosure shall not exceed the following dimensions: 590 x 450 x 420 mm or 23.2 x 17.7 x 16.5" (H x W x D). The loudspeaker shall be the Tannoy VX 15HP.