

TASCAM

BD-01U

Blu-ray Disc Player

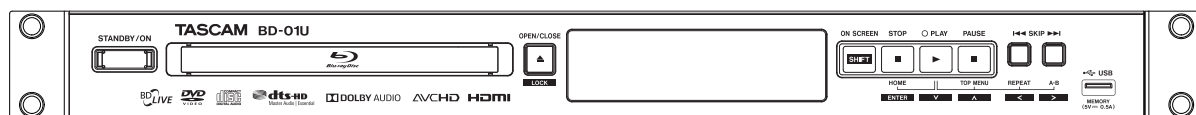





OWNER'S MANUAL

ENGLISH

1 Important Safety Instructions

This appliance has a serial number located on the rear panel. Please record the model number and serial number and retain them for your records.

Model Number _____
Serial Number _____

<p>WARNING: TO REDUCE THE RISK OF FIRE OR ELECTRIC SHOCK, DO NOT EXPOSE THIS APPARATUS TO RAIN OR MOISTURE.</p> <p>CAUTION: TO REDUCE THE RISK OF ELECTRIC SHOCK, DO NOT REMOVE COVER (OR BACK). NO USER-SERVICEABLE PARTS INSIDE. REFER SERVICING TO QUALIFIED SERVICE PERSONNEL.</p>	  	<p>CAUTION RISK OF ELECTRIC SHOCK DO NOT OPEN</p> <p>The lightning flash with arrowhead symbol, within an equilateral triangle, is intended to alert the user to the presence of uninsulated "dangerous voltage" within the product's enclosure that may be of sufficient magnitude to constitute a risk of electric shock to persons.</p> <p>The exclamation point within an equilateral triangle is intended to alert the user to the presence of important operating and maintenance (servicing) instructions in the literature accompanying the appliance.</p>	
--	---	---	---

The important note and rating are located on the rear or bottom of the cabinet.

 The symbol for CLASS II (Double Insulation)

The label on the right is applied on the rear panel.

1. This unit is a CLASS 1 LASER PRODUCT and employs a laser inside the cabinet.
2. To prevent the laser from being exposed, do not remove the cover. Refer servicing to qualified personnel.
- If you are experiencing problems with this product, contact the store where you purchased the unit for a service referral. Do not use the product until it has been repaired.



CAUTION: USE OF CONTROLS OR ADJUSTMENTS OR PERFORMANCE OF PROCEDURES OTHER THAN THOSE SPECIFIED HEREIN MAY RESULT IN HAZARDOUS RADIATION EXPOSURE.

1. Read these instructions.
2. Keep these instructions.
3. Heed all warnings.
4. Follow all instructions.
5. Do not use this apparatus near water.
6. Clean only with dry cloth.
7. Do not block any ventilation openings. Install in accordance with the manufacturer's instructions.
8. Do not install near any heat sources such as radiators, heat registers, stoves, or other apparatus (including amplifiers) that produce heat.

9. Do not defeat the safety purpose of the polarized or grounding-type plug. A polarized plug has two blades with one wider than the other. A grounding type plug has two blades and a third grounding prong. The wide blade or the third prong are provided for your safety. If the provided plug does not fit into your outlet, consult an electrician for replacement of the obsolete outlet.
10. Protect the power cord from being walked on or pinched particularly at plugs, convenience receptacles, and the point where they exit from the apparatus.
11. Only use attachments/accessories specified by the manufacturer.
12. Use only with the cart, stand, tripod, bracket, or table specified by the manufacturer, or sold with the apparatus. When a cart is used, use caution when moving the cart/apparatus combination to avoid injury from tip-over.
13. Unplug this apparatus during lightning storms or when unused for long periods of time.
14. Refer all servicing to qualified service personnel. Servicing is required when the apparatus has been damaged in any way, such as power-supply cord or plug is damaged, liquid has been spilled or objects have fallen into the apparatus, the apparatus has been exposed to rain or moisture, does not operate normally, or has been dropped..



15. **Damage Requiring Service** Unplug the apparatus from the wall outlet and refer servicing to qualified service personnel under the following conditions:
- When the power-supply cord or plug is damaged,
 - If liquid has been spilled, or objects have fallen into the apparatus,
 - If the apparatus has been exposed to rain or water,
 - If the apparatus does not operate normally by following the operating instructions. Adjust only those controls that are covered by the operating instructions as an improper adjustment of other controls may result in damage and will often require extensive work by a qualified technician to restore the apparatus to its normal operation,
 - If the apparatus has been dropped or damaged in any way, and
 - When the apparatus exhibits a distinct change in performance this indicates a need for service.
16. **Object and Liquid Entry**
Never push objects of any kind into the apparatus through openings as they may touch dangerous voltage points or short-out parts that could result in a fire or electric shock.
WARNING: The apparatus shall not be exposed to dripping or splashing and no objects filled with liquids, such as vases shall be placed on the apparatus. Don't put candles or other burning objects on top of this unit.
17. **Batteries**
Always consider the environmental issues and follow local regulations when disposing of batteries.
18. If you install the apparatus in a built-in installation, such as a bookcase or rack, ensure that there is adequate ventilation.
Leave 20 cm (8") of free space at the top and sides and 10 cm (4") at the rear. The rear edge of the shelf or board above the apparatus shall be set 10 cm (4") away from the rear panel or wall, creating a fluelike gap for warm air to escape.
19. Slots and openings in the cabinet at the sides and underneath are provided for ventilation. To ensure reliable operation and to protect the unit from overheating, these openings must not be blocked or covered.
Avoid installation in enclosed spaces such as bookcases unless suitable ventilation is provided.

Power

WARNING

BEFORE PLUGGING IN THE UNIT FOR THE FIRST TIME, READ THE FOLLOWING SECTION CAREFULLY.

AC outlet voltages vary from country to country. Make sure that the voltage in your area meets the voltage requirements printed on the unit's rear panel (e.g., AC 110-240 V, 50/60 Hz or AC 120 V, 60 Hz). The power cord plug is used to disconnect this unit from the AC power source. Make sure that the plug is readily operable (easily accessible) at all times. Pressing the **⏻/I (STANDBY/ON)** button to select Standby mode does not fully disconnect from the mains. If you do not intend to use the unit for an extended period, remove the power cord from the AC outlet.

CAUTION

- Do not expose this apparatus to drips or splashes.
- Do not place any objects filled with liquids, such as vases, on the apparatus.
- Do not install this apparatus in a confined space such as a book case or similar unit.
- The apparatus should be located close enough to the AC outlet so that you can easily reach the power cord plug at any time.
- If the product uses batteries (including a battery pack or installed batteries), they should not be exposed to sunshine, fire or excessive heat.
- CAUTION** for products that use replaceable lithium batteries:
there is danger of explosion if a battery is replaced with an incorrect type of battery. Replace only with the same or equivalent type.

Model for USA

This device complies with Part 15 of the FCC Rules. Operation is subject to the following two conditions:

- (1) **This device may not cause harmful interference, and**
- (2) **This device must accept any interference received, including interference that may cause undesired operation.**

Note

This equipment has been tested and found to comply with the limits for a Class B digital device, pursuant to Part 15 of FCC Rules. These limits are designed to provide reasonable protection against harmful interference in a residential installation.

This equipment generates, uses and can radiate radio frequency energy and, if not installed and used in accordance with the instructions, may cause harmful interference to radio communications. However, there is no guarantee that interference will not occur in a particular installation. If this equipment does cause harmful interference to radio or television reception, which can be determined by turning the equipment off and on, the user is encouraged to try to correct the interference by one or more of the following measures:

- Reorient or relocate the receiving antenna.
- Increase the separation between the equipment and receiver.
- Connect the equipment into an outlet on a circuit different from that to which the receiver is connected.
- Consult the dealer or an experienced radio/TV technician for help.

CAUTION

Changes or modifications to this equipment not expressly approved by TEAC CORPORATION for compliance could void the user's authority to operate this equipment.

Model for Canada

Industry Canada's Compliance Statement:

This Class B digital apparatus complies with Canadian ICES-003.

DECLARATION OF CONFORMITY

We, TEAC AUDIO EUROPE, Liengnitzer Straße 6,82194 Gröbenzell, Germany declare in own responsibility, the TEAC product described in this manual is in compliance with the corresponding technical standards.



FCC Information for User

FCC WARNING:

The user changes or modifications not expressly approved by the party responsible for compliance could void the user's authority to operate the equipment.

This unit contains a semiconductor laser system and is classified as a "CLASS 1 LASER PRODUCT". So, to use this model properly, read this Instruction Manual carefully. In case of any trouble, please contact the store where you purchased the unit.

To prevent being exposed to the laser beam, do not try to open the enclosure.

CAUTIONS ABOUT BATTERIES

This product uses batteries. Misuse of batteries could cause a leak, rupture or other trouble. Always abide by the following precautions when using batteries.

- Never recharge non-rechargeable batteries. The batteries could rupture or leak, causing fire or injury.
- When installing batteries, pay attention to the polarity indications (plus/minus (+/-) orientation), and install them correctly in the battery compartment as indicated. Putting them in backward could make the batteries rupture or leak, causing fire, injury or stains around them.
- When you store or dispose batteries, isolate their terminals with insulation tape or something like that to prevent them from contacting other batteries or metallic objects.
- When throwing used batteries away, follow the disposal instructions indicated on the batteries and the local disposal laws.
- Do not use batteries other than those specified. Do not mix and use new and old batteries or different types of batteries together. The batteries could rupture or leak, causing fire, injury or stains around them.
- Do not carry or store batteries together with small metal objects. The batteries could short, causing leak, rupture or other trouble.
- Do not heat or disassemble batteries. Do not put them in fire or water. Batteries could rupture or leak, causing fire, injury or stains around them.
- If the battery fluid leaks, wipe away any fluid on the battery case before inserting new batteries. If the battery fluid gets in an eye, it could cause loss of eyesight. If fluid does enter an eye, wash it out thoroughly with clean water without rubbing the eye and then consult a doctor immediately. If the fluid gets on a person's body or clothing, it could cause skin injuries or burns. If this should happen, wash it off with clean water and then consult a doctor immediately.
- The unit power should be off when you install and replace batteries.
- Remove the batteries if you do not plan to use the unit for a long time. Batteries could rupture or leak, causing fire, injury or stains around them. If the battery fluid leaks, wipe away any fluid on the battery compartment before inserting new batteries.
- Do not disassemble a battery. The acid inside the battery could harm skin or clothing.



Model for USA

This product has been designed and manufactured according to FDA regulations "title 21, CFR, chapter 1, subchapter J, based on the Radiation Control for Health and Safety Act of 1968", and is classified as class I laser product. There is not hazardous invisible laser radiation during operation because invisible laser radiation emitted inside of the product is completely confined in the protective housings.

The label required for this regulation is located in between the HDMI OUTPUT and the RS-232C ports on the rear panel.

For European Customers

Disposal of electrical and electronic equipment and batteries and/or accumulators

- (a) All electrical/electronic equipment and waste batteries/accumulators should be disposed of separately from the municipal waste stream via collection facilities designated by the government or local authorities.
- (b) By disposing of electrical/electronic equipment and waste batteries/accumulators correctly, you will help save valuable resources and prevent any potential negative effects on human health and the environment.
- (c) Improper disposal of waste electrical/electronic equipment and batteries/accumulators can have serious effects on the environment and human health because of the presence of hazardous substances in the equipment.
- (d) The Waste Electrical and Electronic Equipment (WEEE) symbols, which show wheeled bins that have been crossed out, indicate that electrical/electronic equipment and batteries/accumulators must be collected and disposed of separately from household waste.

If a battery or accumulator contains more than the specified values of lead (Pb), mercury (Hg), and/or cadmium (Cd) as defined in the Battery Directive (2006/66/EC), then the chemical symbols for those elements will be indicated beneath the WEEE symbol.

- (e) Return and collection systems are available to end users. For more detailed information about the disposal of old electrical/ electronic equipment and waste batteries/accumulators, please contact your city office, waste disposal service or the shop where you purchased the equipment.

AC Fuse

The AC fuse inside the unit is not userserviceable. If you cannot turn on the unit, contact your TEAC dealer.

Care

Occasionally you should dust the unit all over with a soft cloth. For stubborn stains, use a soft cloth dampened with a weak solution of mild detergent and water. Dry the unit immediately afterward with a clean cloth. Don't use abrasive cloths, thinners, alcohol, or other chemical solvents, because they may damage the finish or remove the panel lettering.

Never Touch this Unit with Wet Hands

Never handle this unit or its power cord while your hands are wet or damp. If water or any other liquid gets inside this unit, have it checked by your TEAC dealer.

Handling Notes

- If you need to transport this unit, use the original packaging to pack it how it was when you originally bought it.
- Do not leave rubber or plastic items on this unit for a long time, because they may leave marks on the case.
- This unit's top and rear panels may get warm after prolonged use. This is normal.
- If you do not use this unit for a long time, it may not work properly the next time you turn it on, so be sure to use it occasionally.
- When you've finished using this unit, remove all discs and turn off the power.

Installing this Unit

- Install this unit in a well-ventilated location.
- Ensure that there is adequate ventilation all around this unit, especially if it is installed in an audio rack. If the ventilation is inadequate, the unit may overheat, leading to malfunction.
- Do not expose this unit to direct sunlight or heat sources, because its internal temperature may rise, shortening the life of the optical pickup.
- Avoid damp and dusty places, and places subject to vibrations from loudspeakers.
- Never put the unit on top of, or directly above a loudspeaker.
- Install this unit horizontally. Never use it on its side or on a sloping surface, because it may cause a malfunction.
- If you install this unit near a TV, radio, or VCR, the picture and sound quality may be affected. If this occurs, move this unit away from the TV, radio, or VCR.
- If you are mounting the unit in a rack, leave 1U of space above it and 4 inch (10 cm) or more of space at the rear. Use the rack-mounting kit to mount the unit in a standard 19-inch equipment rack, as shown in this section.

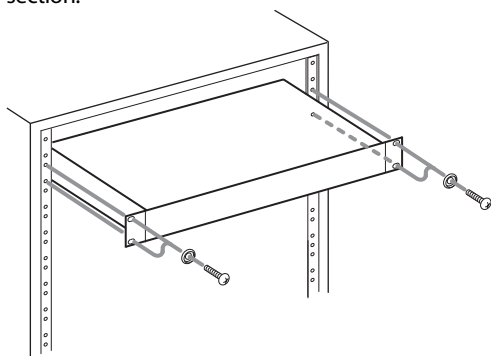

To Obtain a Clear Picture

This unit is a high-tech, precision device. If the lens on the optical pickup, or the disc drive mechanism becomes dirty or worn, the picture quality may be affected. To maintain the best picture quality, we recommend regular inspection and maintenance (cleaning or worn part replacement) every 1,000 hours of use depending on the operating environment. Contact your TEAC dealer for details.

Moisture Condensation

Moisture condensation may damage this unit.

Read the following carefully: Moisture may condense on the lens of the optical pickup, one of the most important parts inside this unit.

- Moisture condensation can occur in the following situations:
 - The unit is moved from a cold place to a warm place.
 - A heater is turned on, or cold air from an air conditioner is hitting the unit.
 - In the summer, when this unit is moved from an air conditioned room to a hot and humid place.
 - The unit is used in a humid place.
- Do not use this unit when there's the possibility of moisture condensation occurring. Doing so may damage your discs and certain parts inside this unit. If condensation does occur, unplug the power cord and leave the unit for two to three hours in the room temperature.

About this Manual

This manual explains how to use all of this unit's functions. Although the Blu-ray Disc™/DVD standard offers many special features, not all discs use them all, so depending on the disc being played, this unit may not respond to certain functions. See the disc's sleeve notes for supported features.

Never use a gas duster on this unit. The gas trapped inside of this unit may cause ignition and explosion.

For model having a power cord with a polarized plug:

CAUTION:

For USA/Canada model

TO PREVENT ELECTRIC SHOCK, MATCH WIDE BLADE OF PLUG TO WIDE SLOT, FULLY INSERT.

2 SUPPLIED ACCESSORIES

- Remote Control
- Batteries (AAA (R03), 1.5V × 2)
- Rack-mounting Kit (Screw × 4, Washer ×4)
- Owner's Manual
 - The warranty is included at the end of this manual.

■ Note about Recycling

- This unit's packaging materials are recyclable and can be reused. Please dispose of any materials in accordance with your local recycling regulations.
- Batteries should never be thrown away or incinerated but disposed of in accordance with your local regulations concerning chemical wastes.

■ Maintenance

Servicing

- Please refer to relevant topics on "TROUBLESHOOTING" on page 48 before returning the product.
- If this unit becomes inoperative, do not try to correct the problem by yourself. There are no user-serviceable parts inside. Turn the unit to the standby mode, unplug the power plug, and contact the dealer from whom you purchased this unit.

Disc handling

- For best results, keep your discs clean. Fingerprints and dust can affect the sound and picture quality and should be removed as follows. Using a clean, soft cloth, wipe from the center outwards, as shown. Never wipe in a circular direction.
- To remove stubborn dust or dirt, wipe the disc with a damp, soft cloth, and then dry it with a dry cloth.
- Never use solvent-based cleaning fluids, such as thinner or benzine, commercially available cleaners, or antistatic sprays intended for vinyl records, because they may damage the disc.

IR signal check

- If the remote control is not working properly, you can use a digital camera (including a cellular phone with built-in camera) to see if it is sending out an infrared signal.

With a digital camera (including built-in cell phone cameras): Point a digital camera towards the remote control. Push any button on the remote control and look through the digital camera. If the infrared light appears through the camera, the remote control is working.

Copyright

- It is forbidden by law to copy, broadcast, show, broadcast on cable, play in public, or rent copyrighted material without permission. Commercial BD-video/ DVD-video discs are copy-protected, and any recordings made from these discs will be distorted. This item incorporates copy protection technology that is protected by U.S. patents and other intellectual property rights of Rovi Corporation. Reverse engineering and disassembly are prohibited.
This product incorporates copy protection technology that is protected by U.S. patents and other intellectual property rights of Rovi Corporation. The use of Rovi Corporation's copy protection technology in the product must be authorized by Rovi Corporation. Reverse engineering and disassembly are prohibited.

■ Other information

About this owner's manual

- Button operation instructions in this owner's manual are based on remote control operations unless otherwise noted.

Descriptions in this owner's manual

- Buttons for operations are described in a bold typeset (e.g. **SHIFT**).
- Character strings displayed on screen are described in between quotation marks (e.g. "Track").
- "Blu-ray Disc™" may be represented as "BD" .
- "SD Card" collectively means SD / miniSD / microSD / SDHC / miniSDHC / microSDHC Memory card.
- "Windows Media™ Audio" may be represented as "WMA".

Online registration

- Customers in the USA, please perform the online user registration at the TASCAM website.
<http://tascam.com/support/registration/>

3 TRADEMARK INFORMATION



Manufactured under license from Dolby Laboratories. Dolby, Dolby Audio, and the double-D symbol are trademarks of Dolby Laboratories.



For DTS patents, see <http://patents.dts.com>. Manufactured under license from DTS Licensing Limited. DTS, DTS-HD, the Symbol, & DTS and the Symbol together are registered trademarks, and DTS-HD Master Audio | Essential is a trademark of DTS, Inc. © DTS, Inc. All Rights Reserved.



The terms HDMI and High-Definition Multimedia Interface, and the HDMI Logo are trademarks or registered trademarks of HDMI Licensing LLC in the United States and other countries.



"x.v.Color" and "x.v.Color" logo are trademarks of Sony Corporation.



Oracle and Java are registered trademarks of Oracle and/or its affiliates. Other names may be trademarks of their respective owners.

Windows Media is either a registered trademark or trademark of Microsoft Corporation in the United States and/or other countries.

This product is protected by certain intellectual property rights of Microsoft. Use or distribution of such technology outside of this product is prohibited without a license from Microsoft.



"AVCHD" and the "AVCHD" logo are trademarks of Panasonic Corporation and Sony Corporation.



Blu-ray Disc™, Blu-ray™, BD-Live™, BONUSVIEW™, and the logos are trademarks of the Blu-ray Disc Association.

 is a trademark of DVD Format/Logo Licensing Corporation.

TASCAM is a trademark of TEAC CORPORATION, registered in the U.S. and other countries.

Other company names, product names and logos in this document are the trademarks or registered trademarks of their respective owners.

License

This product includes some open source software that is subject to the GNU General Public License (GPL), GNU Lesser General Public License (LGPL) and/or copyright licenses, disclaims and notices. You can confirm further information about these in the "OSS" section in "Settings" of this product. If you are interested in obtaining GPL and LGPL source code used in this product, please contact <http://www.teac.co.jp/support/opensource/index.html>

4 FEATURES

Features

Blu-ray Disc™

You can play a Blu-ray Disc™, which is capable of storing five times more data than a conventional DVD.

BD-Java

With Blu-ray™ discs that support Java applications, explore interactive functions such as games or interactive menus.

DVD upscaling for enhanced picture quality

Your current DVDs will look even better than before thanks to video upscaling. Upscaling will increase the resolution of standard definition DVD to high definition up to 1080p over an HDMI connection. The picture will be less jagged and more realistic for a near high definition experience.

Enjoy your content on different kinds of media

Full backwards compatibility with DVD, CD and USB flash drive ensures that you can continue to enjoy your current audio-video collection. Additionally, you can enjoy AVCHD / MP3 / WMA / WAV / JPEG files.

Listen to rich multi-channel surround sound

Multi-channel surround sound realizes real-to-life sound and makes you feel that you are really there.

Easy and simple connection to your HDTV via HDMI

Connect this unit to your HDTV with a single HDMI (High-Definition Multimedia Interface) cable. It is recommended to use a High Speed HDMI cable for better compatibility. The high definition video output signal will be transferred to your HDTV without conversion to analog signals, so you will get excellent picture and sound quality, completely free from noise. Thanks to other multiple outputs, you can also easily connect to your home theater system or amplifier.

HDMI CEC (Consumer Electronics Control)

This unit supports HDMI CEC, which allows integrated system control over HDMI and is part of the HDMI standard. This function may not work properly on some devices.

PiP (BONUSVIEW™)

Some BD-videos have the Picture-in-Picture function which enables you to display the secondary video in the primary video. You can call up the secondary video whenever the scene contains the secondary video.

BD-Live™

BD-Live™ (BD-ROM version 2 Profile 2.0) that allows interactive functions to be used when this unit is connected to the Internet in addition to the BONUSVIEW™ function. The various functions differ depending on the disc.

Pop-up menu

Some BD-videos have a pop-up menu which is a navigation menu that can be called up and be operated on the TV screen without interrupting playback. You can call up the pop-up menu by pressing **[POP UP/MENU]**. Contents in the pop-up menu vary depending on the disc.

HDMI Deep Color

Deep Color reduces posterization (color banding) effects of the playback image.

HDMI 1080p/24 output (Blu-ray Disc™ only)

This unit is equipped with the feature which can provide smooth movement during playback of film originated material with the frame rate of 24 frames per second with progressive. (Available only when the display device is connected by an HDMI cable.) Refer to "Video Resolution" on page 44.

Playing back contents from a USB flash drive

You can play back MP3 / WMA / WAV / JPEG files stored in a USB flash drive. BD-ROM Profile 2.0 (BD-Live™) and Profile 1.1 discs sometimes store picture-in-picture commentary, subtitles or other extras in the USB flash drive for use during playback with the BD-video.

Playing back AVCHD files









This unit supports playback of AVCHD format files (new format for high definition video camcorders) recorded on disc / SD cards using USB card reader / USB hub (not supplied). Your high definition personal archive is playable in HD quality.

x.v.Color

This unit supports playback of video contents on discs recorded with "x.v.Color" technology. To watch this video content with the "x.v.Color" space, a TV or other display device supporting both video image reproduction using "x.v.Color" standard and capability of manual switching of its color space setting is required. Please refer to the owner's manual of your display device for further information.

Symbols Used in this Manual

To specify which media type each function is applicable to, we put the following symbols at the beginning of each item to operate.

Symbol	Description
	Description refers to BD-video
	Description refers to DVD-video
	Description refers to DVD-RW/-R recorded in VR mode
	Description refers to audio CD / DTS-CD
	Description refers to DVD-RW/-R and SD Card* with AVCHD files
	Description refers to BD-RE/-R, DVD-RW/-R, CD-RW/-R and USB flash drive and SD Card* with MP3 files
	Description refers to BD-RE/-R, DVD-RW/-R, CD-RW/-R and USB flash drive and SD Card* with Windows Media™ Audio files
	Description refers to BD-RE/-R, DVD-RW/-R, CD-RW/-R and USB flash drive, SD Card* with WAV files
	Description refers to BD-RE/-R, DVD-RW/-R, CD-RW/-R and USB flash drive, SD Card* with JPEG files

* AVCHD/MP3/WMA/WAV/JPEG files stored on an SD card can be played by connecting a USB card reader (not supplied) to this unit.

If you do not find any of the symbols listed above under the function heading, the operation is applicable to all media.

5 FUNCTIONAL OVERVIEW

Front Panel

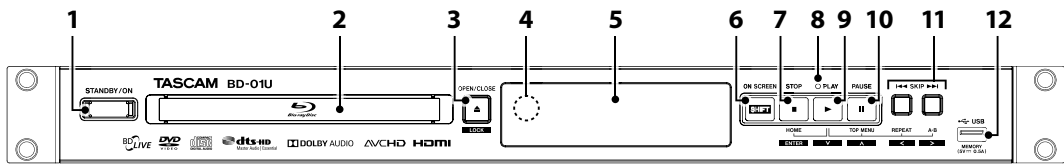

* The unit can also be turned on by pressing these buttons.

- | | | |
|----------------------------------|---|--|
| 1. STANDBY/ON button | 6. SHIFT button | 9. PLAY button* |
| 2. Disc tray | 7. STOP button | 10. PAUSE button |
| 3. OPEN/CLOSE button* | 8. PLAY indicator | 11. <<SKIP>> (skip down/up) buttons |
| 4. Infrared sensor window | This indicator lights up in green during playback | 12. USB input |
| 5. Panel display | | |

■ Button combinations and the unit's behavior

Button combination		Button press	Behavior
OPEN/CLOSE ▲	—	Short press	Opens / Closes the disc tray. (p.28)
SHIFT	—		Displays the on-screen display menu. (p.17)
STOP ■	—		Stops playback. (p.29, 33)
PLAY ►	—		Starts playback or resumes. (p.29, 33)
PAUSE	—		Pauses playback. (p.29) While pausing: Forwards playback frame by frame.
SKIP ◀◀	—		Skips to the previous chapter, track or file. (p.29)
SKIP ▶▶	—		Skips to the next chapter, track or file. (p.29)
STOP ■	—	Long press	Sets "HDCP Auto" to "On". (p.45)
PAUSE	—		Resets the HDMI resolution to its default setting.
SKIP ◀◀	—		Fast-reverses the playback.*1 (p.32)
SKIP ▶▶	—		Fast-forwards the playback.*2 (p.32)
SHIFT	OPEN/CLOSE ▲	Simultaneous press	Changes the LOCK setting. (p.47)
SHIFT	STOP ■		Confirms or selects menu items.
SHIFT	PLAY ►		▼ (down)
SHIFT	PAUSE		▲ (up)
SHIFT	SKIP ◀◀		◀ (left)
SHIFT	SKIP ▶▶		▶ (right)
PLAY ►	STOP ■		Displays the Home menu. (p.16)
PLAY ►	PAUSE		Displays the top menu/title menu of the disc. (p.31)
PLAY ►	SKIP ◀◀		Selects repeat modes. (p.33)
PLAY ►	SKIP ▶▶	Plays back a defined section between point A and B repeatedly. (p.33)	

*1 After 5 seconds of holding the button, the speed will decrease by 1 step every 1 second.

*2 After 5 seconds of holding the button, the speed will increase by 1 step every 1 second.

⚠ Caution

- Do not connect any device other than a USB flash drive, USB card reader or USB hub into USB input. (e.g. PC, external HDD, MP3 player, digital camera, keyboard, mouse, etc.)

Rear Panel

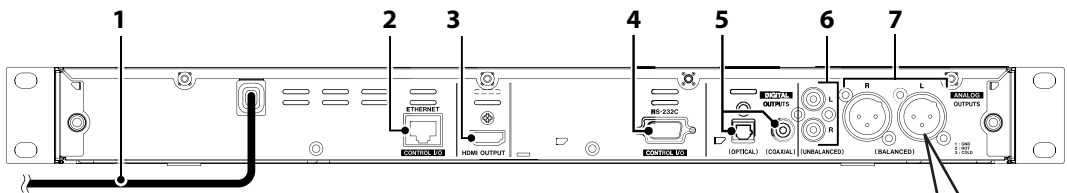

- 1. AC Cord**
Plug in after all necessary connections are made. (p.23)
- 2. ETHERNET terminal**
Used to connect an Ethernet cable (LAN cable) in order to use the BD-Live™ functions, and enables operation from an external controller (e.g. PC).
- 3. HDMI OUTPUT jack**
Used to connect a TV or AV amplifier using an HDMI cable. (p.18)
- 4. RS-232C terminal**
Used to connect a PC/external controller using an RS-232C (D-Sub/9 pins) cable. (p.23)
- 5. DIGITAL OUTPUTS (OPTICAL/COAXIAL) jacks**
Used to connect a digital audio device using a digital optical audio cable/ digital coaxial audio cable (sold separately) .
- 6. ANALOG OUTPUTS (UNBALANCED) jacks**
Used to connect an analog audio device using an RCA (unbalanced) audio cable.
- 7. ANALOG OUTPUTS (BALANCED) jacks**
Used to connect an analog audio device using an XLR (balanced) audio cable.

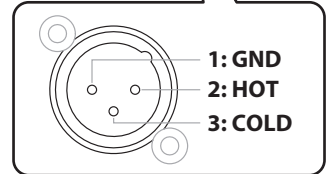

⚠ Caution

- Do not touch the inner pins of the jacks on the rear panel. Electrostatic discharge may cause permanent damage to the unit.
- This unit does not have an RF modulator.

Remote Control

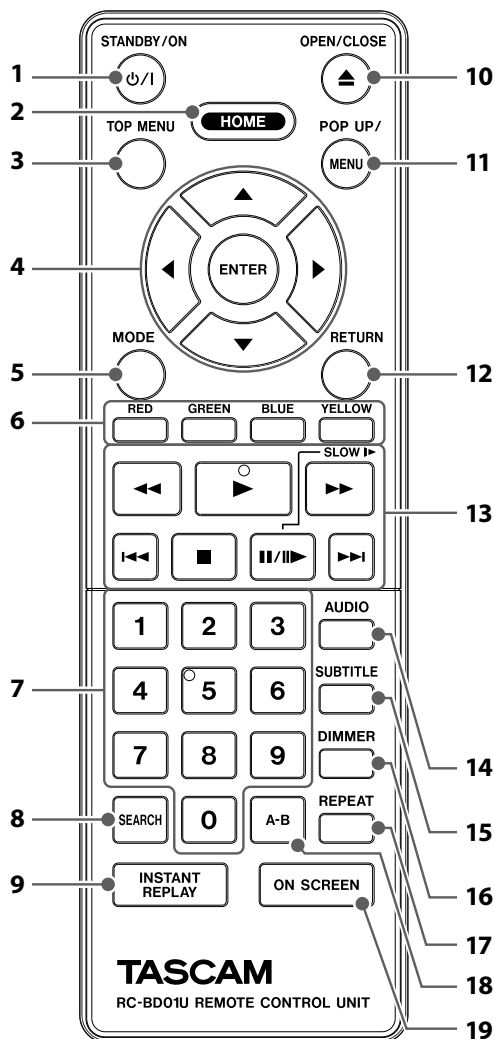

* The unit can also be turned on by pressing these buttons.

1. **⏻/| (STANDBY/ON) button**
 - Press to turn on the unit, or to turn the unit into the standby mode. (To completely shut down the unit, you must unplug the AC power cord.)
2. **HOME button**
 - Press to display the home menu.
3. **TOP MENU button**
Blu-ray Disc™:
 - Press to display the top menu.**DVD:**
 - Press to display the title menu.
4. **▲/▼/◀/▶ buttons**
 - Press to select items or settings.**ENTER button**
 - Press to confirm or select menu items.
5. **MODE button**
 - During playback, press to display the play menu.
6. **RED / GREEN / BLUE / YELLOW buttons**
 - Press to activate shortcut keys on some BD-video functions.
 - When file list / thumbnail list is shown, press to switch between pages.
7. **Number buttons**
 - Press to select a chapter during playback.
 - Press to enter numbers in the input field.
8. **SEARCH button**
 - Press to display the search menu.
9. **INSTANT REPLAY button**
 - Press to replay in variable speeds.
10. **▲ (OPEN/CLOSE) button***
 - Press to open or close the disc tray.
11. **POP UP/MENU button**
Blu-ray Disc™:
 - Press to display the pop-up menu.**DVD:**
 - Press to display the disc menu.
12. **RETURN button**
 - Press to return to the previously displayed menu or screen function.

13. ◀◀ (reverse) button

- During playback, press to fast reverse the playback.

▶ (play) button*

- Press to start playback or resume playback.

▶▶ (forward) button

- During playback, press to fast forward the playback.
- In pause mode, press to slow forward the playback.

◀◀ (skip) button

- During playback, press once to return to the beginning of the current title, chapter, track or file.
- During playback, press twice to return to the previous title, chapter, track or file.
- During JPEG playback, press to return to the previous file.

■ (stop) button

- Press to stop playback.

■ (pause) button

- Press to pause playback.
- When playback is in pause mode, press to forward playback frame by frame.

▶| (skip) button

- During playback, press to skip to the next chapter, track or file.

14. AUDIO button

- Press to select the audio channel (such as audio languages) on a disc.

15. SUBTITLE button

- Press to select subtitles on a disc.

16. DIMMER button

- Press to dim the panel display.

17. REPEAT button

- Press to select repeat modes.

18. A-B button

- Press to play back a defined section between point A and B repeatedly.

19. ON SCREEN button

- Press to display the on-screen display menu.

■ Installing the Batteries in the Remote Control

Install 2 AAA(R03) (1.5V) batteries matching the polarity indicated inside battery compartment of the remote control.

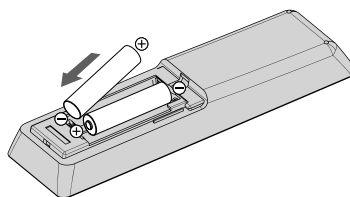

⚠ Caution

Incorrect use of batteries can result in hazards such as leakage and bursting. Please observe the following:

- Use alkaline or standard (carbon-zinc) batteries.
- Do not mix new and old batteries together.
- Do not use different kinds of batteries together. Although they may look similar, different batteries may have different voltages.
- Make sure that the + and - ends of each battery match the indications in the battery compartment.
- Remove batteries from battery compartment, when the remote is not going to be used for a month or more.
- When disposing of used batteries, please comply with governmental regulations or environmental public rules that apply in your country or area.
- Do not recharge, short-circuit, heat, burn or disassemble batteries.

■ Using the Remote Control

Remote Control Usage Guidelines:

- Make sure that there are no obstacles between the remote control and the infrared sensor window on the unit.
- Remote operation may become unreliable if strong sunlight or fluorescent light is shining on the infrared sensor window of the unit.
- Remote controls of different devices can interfere with each other. Avoid using a remote controls of another device which is located close to the unit.
- Replace the batteries when you notice a fall-off in the operating range of the remote control.
- Direct the remote control straight to the infrared sensor window on the unit.
 - Line of sight:
approx. 23 feet (7m)
 - Either side of the center:
approx. 16 feet (5m) within 15°

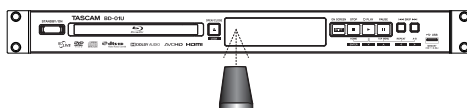

Front Panel Display

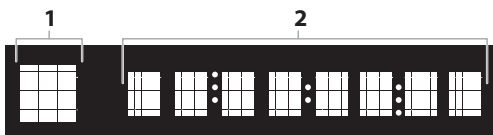

* Brightness of the display can be adjusted. Refer to "Panel Display" in "LIST OF SETTINGS" on page 40.

1. Displays playback status icon. Refer to the table below.
2. Displays various kinds of information such as title number, elapsed time, repeat mode, etc.

Playback Status Icon	Mode
	Playback is in progress
	Stop mode
	Pause mode
	Fast forward mode
	Fast reverse mode
	Slow forward mode
	Appears while repeat function is set

Examples of Display Message

Title is being played back. Indicating the current title number and the elapsed time.

Title number and Chapter number after the search.

Current chapter is in chapter repeat mode.

Loading a disc, USB flash drive or USB card reader.

Home menu is displayed.

Adjusting the Brightness of the Panel Display

Every time [DIMMER] is pressed, the brightness of the panel display will change as follows:

- Auto: Only dims during playback. Otherwise, it is bright.
- Bright: The display panel is always bright.
- Dimmer: The display panel is always dark.

Guide to On-Screen Display

■ Home Menu

When you turn on the unit, the home menu will appear automatically. Otherwise, press [HOME].

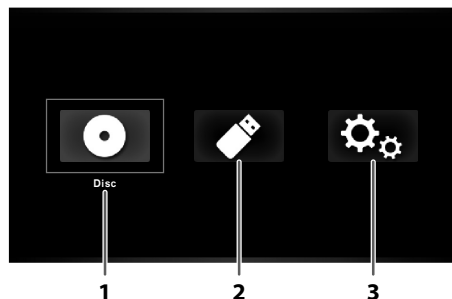

1. **Disc:** Initiates playback of inserted disc, displays a list of tracks / files or the media filter menu
2. **USB:** Displays a list of tracks / files on the connected USB flash drive or the media filter menu
3. **Settings:** To access the setup menu

■ Setup Menu

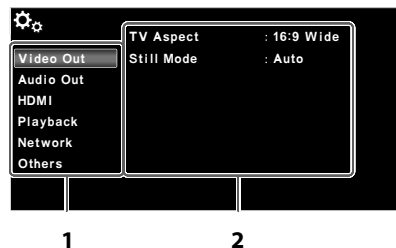

1. **Category**
2. **Menus / Options:** Displays options for the highlighted item on the left whenever available.

■ Play Menu

During playback, press [MODE] to display the play menu. e.g.) Blu-ray Disc™

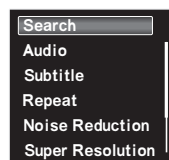

Playback Information

■ During Video Playback

BD-V DVD-V AVCHD

- During playback, press **[ON SCREEN]**.
 - To remove information from the screen, press **[ON SCREEN]** again.

Title / Chapter number



- Title number / Chapter number / Elapsed time
 - TT** : Current title number / Total number of titles
 - CHP** : Current chapter number / Total number of chapters
 - ⏱** : Elapsed time
- Playback status
- Repeat mode
- Media / File type

■ During Picture Playback

JPEG

- During picture playback, press **[ON SCREEN]**.

File number



- TR** : Current file number / Total number of files
 - Playback status
 - Repeat mode
 - Media / File type
- Press **[ON SCREEN]** again.
 - To remove information from the screen, press again.

File name



- 📷** : The file name of the picture currently being selected
- Playback status
- Repeat mode
- Media / File type

■ During Music Playback (while displaying the file list)

CD MP3 WMA WAV

Track / File number



- Track number / File number / Elapsed time
 - TR** : Current track (file) number / Total number of tracks (files)
 - ⏱** : Elapsed time
- Playback status
- Repeat mode
- Media / File type

MP3 WMA WAV

- During playback, press **[ON SCREEN]** repeatedly until the desired information appears.

Music title



- 🎵** : The title of the music file currently being selected
- Playback status
- Repeat mode
- Media / File type

Artist name



- 👤** : The artist's name for the music file currently being selected.
- Playback status
- Repeat mode
- Media / File type

Album title



- 🎧** : The name of the album which contains the music title.
- Playback status
- Repeat mode
- Media / File type

📌 Note

- Information displayed on screen will differ depending on the playback media.
- For audio CD's, music titles, artist names, and album titles will not be displayed.

6 CONNECTIONS

- When you change the connections, all devices should be unplugged.
- When making connections with external devices, please refer to their user manuals for additional setup help.

HDMI Video / Audio Connection

(Supports up to 1080i^{(*)1}, 1080p^{(*)2}, 1080p/24^{(*)3} resolution.)

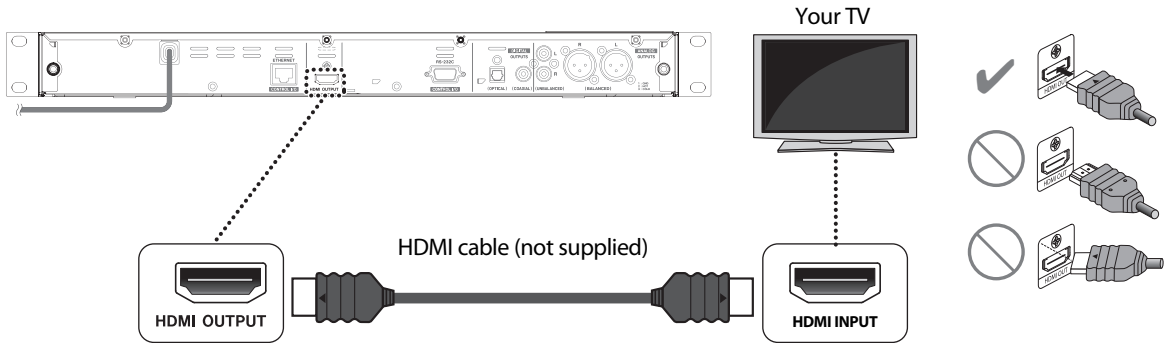

No analog audio connection is required.

- ^{(*)1} 1080i: For USA / Canada: Outputs video data with a frame rate of 30 frames per second.
For Europe: Outputs video data with a frame rate of 25/30 frames per second.
- ^{(*)2} 1080p: For USA / Canada: Outputs video data with a frame rate of 60 frames per second.
For Europe: Outputs video data with a frame rate of 50/60 frames per second.
- ^{(*)3} 1080p/24: Outputs video data with a frame rate of 24 frames per second.

- Do not tilt the connector when inserting it into the HDMI jack, and make sure the shapes of the jack and the connector are matched.
- When connected to an HDCP incompatible display device, the picture will not be displayed properly.
- Use an HDMI cable with the HDMI logo (a certified HDMI cable) for this connection.
High Speed HDMI cable (also known as HDMI category 2 cable) is recommended for better compatibility.

Connection to an Audio System

7.1ch audio with BD-Videos will be available by connecting this unit to a PCM 7.1ch compatible amplifier with an HDMI cable. If your amplifier is compatible with Dolby Audio - Dolby Digital Plus/Dolby TrueHD/DTS-HD, the respective audio outputs are also available.

■ HDMI Audio Connection

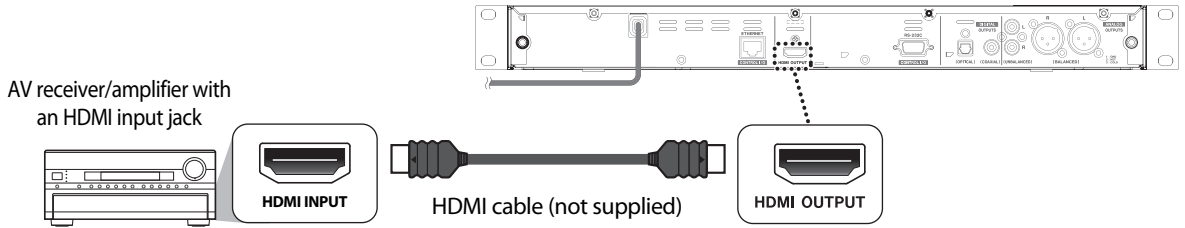

■ 2-Channel Analog Audio Connection

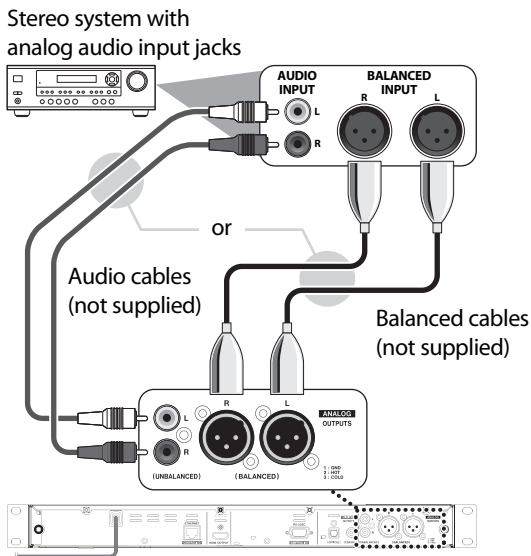

■ Digital Audio Connection

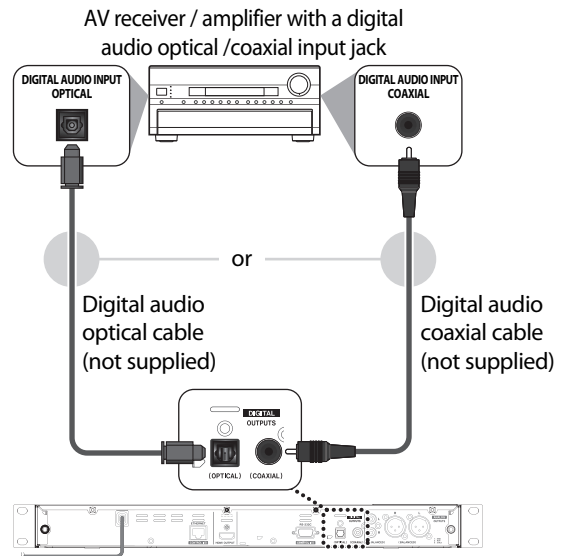

⚠ Caution

When connecting this unit to an AV amplifier:

- After connecting this unit to the amplifier, configure **[HOME]** → “Settings” → “HDMI” → “Audio Out” according to the amplifier’s specifications. (p.38)
- Depending on the connected HDMI compatible device, there is a case where WAV audio is not properly output from the ANALOG OUTPUTS (BALANCED/UNBALANCED). In such cases, configure **[HOME]** → “Settings” → “HDMI” → “Audio Out” → “Off”. Otherwise, connect this unit to an HDMI compatible device that supports the sampling frequency = 96kHz.

■ Audio Output from DIGITAL OUTPUTS(OPTICAL/COAXIAL) jacks

	"Digital Output" setting →	"Bitstream"		"LPCM"	
	"BD Audio Mode" setting →	"HD Audio Output"	"Mix Audio Output"	"HD Audio Output"	"Mix Audio Output"
Media ↓	Audio Source ↓	Which audio format can be output depends on the compatibility of the connected device.			
BD-video	Dolby Digital	Dolby Digital		DownMix 2ch LPCM	
	Dolby Digital Plus	Dolby Digital		DownMix 2ch LPCM ^{*1}	DownMix 2ch LPCM ^{*2}
	Dolby TrueHD	Dolby Digital		DownMix 2ch LPCM ^{*3}	DownMix 2ch LPCM ^{*4}
	DTS [*]	DTS [*]		DownMix 2ch LPCM	
	DTS-HD [*]	DTS [*]		DownMix 2ch LPCM ^{*1}	DownMix 2ch LPCM ^{*5}
	LPCM	DownMix 2ch LPCM		DownMix 2ch LPCM	
DVD-video	Dolby Digital	Dolby Digital		DownMix 2ch LPCM	
	DTS [*]	DTS [*]		DownMix 2ch LPCM	
	LPCM	2ch LPCM		2ch LPCM	
	MPEG ^{*6}	MPEG		DownMix 2ch LPCM	
DVD-VR	Dolby Digital	Dolby Digital		DownMix 2ch LPCM	
	LPCM	2ch LPCM		2ch LPCM	
	MPEG ^{*6}	MPEG		DownMix 2ch LPCM	
DTS-CD	DTS [*]	DTS [*]		DownMix 2ch LPCM	
AVCHD	Dolby Digital	Dolby Digital		DownMix 2ch LPCM	
	LPCM	DownMix 2ch LPCM		DownMix 2ch LPCM	
Audio CD	LPCM	2ch LPCM		2ch LPCM	
MP3	MP3	2ch LPCM		2ch LPCM	
Windows Media™ Audio	WMA	2ch LPCM		2ch LPCM	
WAV	LPCM	DownMix 2ch LPCM		DownMix 2ch LPCM	

*1) Fully decoded.

*2) Only the independent substream is decoded.

*3) Dolby TrueHD stream is decoded.

*4) Only the Dolby Digital substream is decoded.

*5) Only the core substream is decoded.

*6) Europe model only.

Note

- When playing back a BD-video which only contains the primary audio, the audio output will be the same case as "HD Audio Output" even if "BD Audio Mode" is set to "Mix Audio Output".

■ Audio Outputs from ANALOG OUTPUTS(BALANCED/UNBALANCED) jacks

- Multi channel audio, other than monaural or 2ch, will be downmixed to 2ch stereo.

■ Audio Output from HDMI OUTPUT jack

	"Audio Output" setting →	"Bitstream"		"LPCM"		"Off"
	"BD Audio Mode" setting →	"HD Audio Output"	"Mix Audio Output"	"HD Audio Output"	"Mix Audio Output"	Regardless
Media ↓	Audio Source ↓	Which audio format can be output depends on the compatibility of the connected device.				
BD-video	Dolby Digital	Dolby Digital		Multi LPCM		Mute
	Dolby Digital Plus	Dolby Digital Plus	Dolby Digital	Multi LPCM ^{*1}	Multi LPCM ^{*2}	Mute
	Dolby TrueHD	Dolby TrueHD	Dolby Digital	Multi LPCM ^{*3}	Multi LPCM ^{*4}	Mute
	DTS [*]	DTS [*]		Multi LPCM		Mute
	DTS-HD [*]	DTS-HD [*]	DTS [*]	Multi LPCM ^{*1}	Multi LPCM ^{*5}	Mute
	LPCM	Multi LPCM		Multi LPCM		Mute
DVD-video	Dolby Digital	Dolby Digital		Multi LPCM		Mute
	DTS [*]	DTS [*]		Multi LPCM		Mute
	LPCM	2ch LPCM		2ch LPCM		Mute
	MPEG ^{*6}	MPEG		Multi LPCM		Mute
DVD-VR	Dolby Digital	Dolby Digital		Multi LPCM		Mute
	LPCM	2ch LPCM		2ch LPCM		Mute
	MPEG ^{*6}	MPEG		Multi LPCM		Mute
DTS-CD	DTS [*]	DTS [*]		Multi LPCM		Mute
AVCHD	Dolby Digital	Dolby Digital		Multi LPCM		Mute
	LPCM	Multi LPCM		Multi LPCM		Mute
Audio CD	LPCM	2ch LPCM		2ch LPCM		Mute
MP3	MP3	2ch LPCM		2ch LPCM		Mute
Windows Media™ Audio	WMA	2ch LPCM		2ch LPCM		Mute
WAV	LPCM	Multi LPCM		Multi LPCM		Mute

*1) Fully decoded.

*2) Only the independent substream is decoded.

*3) Dolby TrueHD stream is decoded.

*4) Only the Dolby Digital substream is decoded.

*5) Only the core substream is decoded.

*6) Europe model only .

Note

- If the connected device is not compatible with the HDMI BITSTREAM, audio will be output as multi LPCM or 2-channel down-mixed LPCM depending on the capability of the connected device even if you select "Bitstream" in "Audio Output" setting.
- When playing back a BD-video which only contains the primary audio, the audio output will be the same case as "HD Audio Output" even if the "BD Audio Mode" is set to "Mix Audio Output".

■ connection to the Network

By connecting this unit to the Internet, you can access BD-Live™.

- For more information about BD-Live™, refer to “Enjoying BD-Live™ Discs Using the Internet” on page 34.

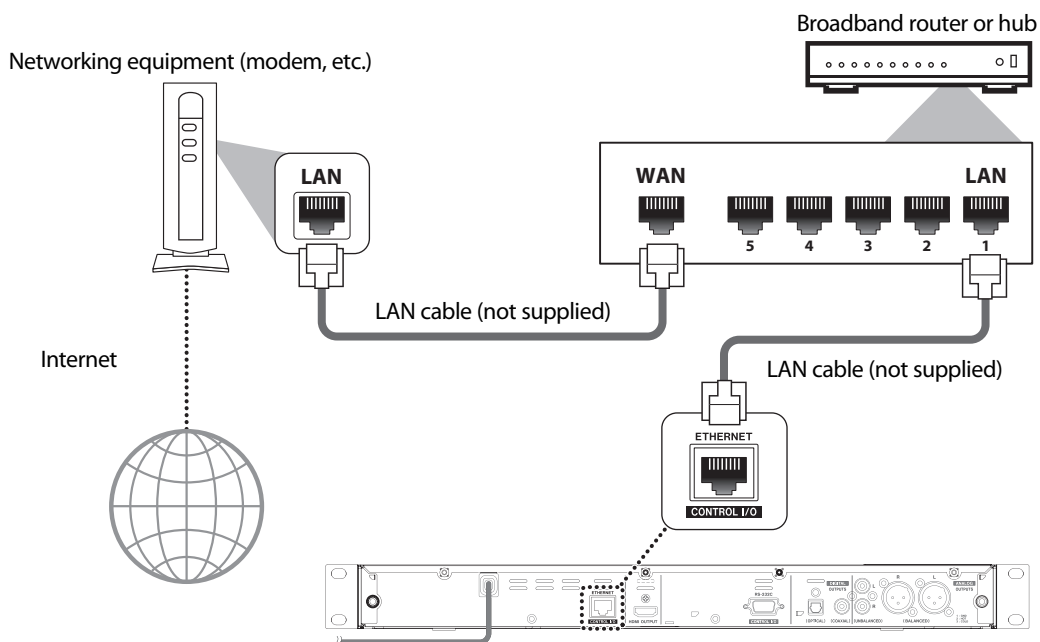

⚠ Caution

- Do not insert any cable other than a LAN cable to the LAN terminal to avoid damaging the unit.

🔧 Note

- After connecting a LAN cable, set up necessary network settings. (For the network setup, refer to “Network Connection” on page 41.)
- If your modem does not have router functions, connect a router.
- If your modem has router functions but there is no vacant port, add a hub.
- For a router, use a router which supports 10BASE-T / 100BASE-TX ETHERNET standard.
- Please purchase shielded LAN cables at your local store and use them when you connect to network equipment.

Connecting an External Controller to Your Unit

This unit is operable with an external controller, such as a PC, using an RS-232C cable or LAN cable. Contact TASCAM Customer Support for the command prompt protocol of Ethernet and RS-232C communication.

- When you operate the unit using an external controller, make sure that you (with the controller) are close enough to the unit so that you can visually confirm the unit's behavior / status.

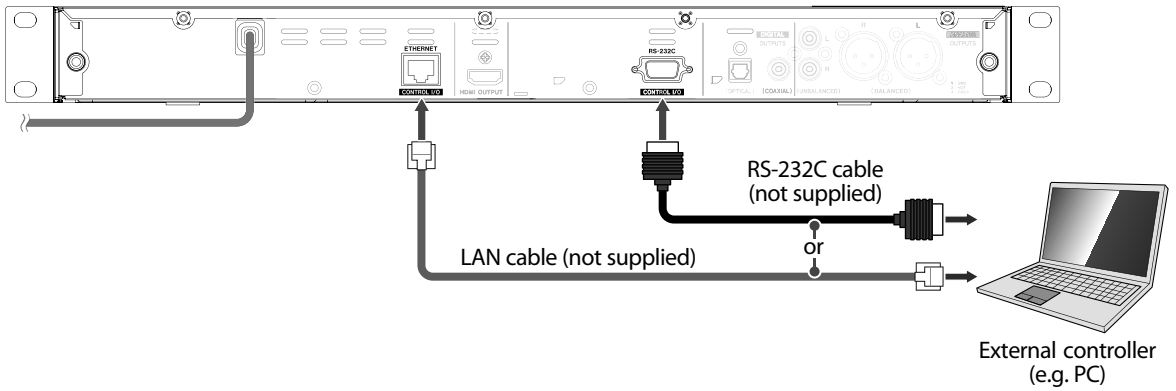

Connecting the AC Cord

After you made all necessary connections, connect the AC cord to the AC outlet. Insert the plugs securely. Incomplete connections will generate noise.

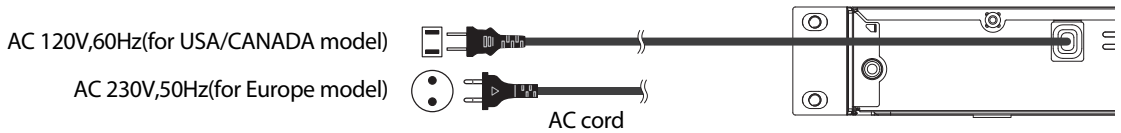

Note

- The type of plug differs depending on your country.

7 BEFORE YOU START

Finding the Viewing Channel / Source on Your TV

After you have completed all the connections, you must find the viewing channel (external input source) on your TV.

1. After you have made all the necessary connections, press [⏻/I (STANDBY/ON)] to turn on the unit.
2. Turn on your TV.
3. Press the button on the TV's remote control that accesses the external input channel. It may be labelled "SOURCE", "AV", "AUX" or "SELECT" (refer to your TV's user manual).

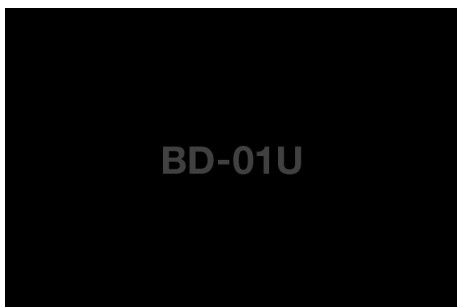

This is the correct viewing channel (external input source).

- If the TV is connected by an HDMI cable, it may take a while for the opening picture to come up.
- If a certain amount of time has passed since you turned on the unit, the initialization screen will appear for the first time you turn on the unit. Perform initialization.



1. Press [ENTER].
 - The Player Menu screen will appear.
2. Use [▲/▼] to select your language, then press [ENTER].

Deutsch: The Player Menu language will be German.

English: The Player Menu language will be English.

Español: The Player Menu language will be Spanish.

français: The Player Menu language will be French.

Italiano: The Player Menu language will be Italian.

- The Auto Power Off screen will appear.

3. Use [▲/▼] to select "On" or "Off", then press [ENTER].

On: After 20 minutes of inactivity, this unit will automatically be turned off.

Off: Even after 20 minutes of inactivity, this unit will stay On.

- The Complete screen will appear.

4. Press [ENTER].

- "Initialization" is completed.
- Home menu will appear.

8 INFORMATION ON PLAYBACK

Information on Playback

■ Playable Discs and Files

Playable discs	Logos
Blu-ray Disc™ - BD-video - BD-R(Ver.1.1/1.2/1.3)* - BD-RE(Ver.2.1)* (Recorded in BDMV format) (Disc not finalised may not be played back.)	
DVD-video	
DVD-RW (finalized discs only)	
DVD-R (finalized discs only)	
CD-DA (audio CD)	
CD-RW	
CD-R	
DTS-CD	—

* Due to the intentional progression of the Blu-ray Disc™ format by its standard setting authority, the company cannot guarantee or warrant the playability of future extensions of the Blu-ray Disc™ format with this product.

Playable files	Media
AVCHD	DVD-RW/-R, SD cards
MP3	BD-RE/-R,
Windows Media™ Audio	DVD-RW/-R, CD-RW/-R,
WAV	USB flash drive,
JPEG	SD Card

Readable devices	Playable files / data
USB flash drive	MP3, WMA, WAV, JPEG, picture-in-picture commentary, subtitles or other extras for BD-ROM ver. 2 (Profile 2.0 / Profile 1.1)
SD Card using USB card reader (not supplied)	MP3, WMA, WAV, JPEG, AVCHD

■ Recommended Specifications

AVCHD

This unit cannot play back stand-alone AVCHD files (*.m2ts, *.mts or *.m2t) written to a DVD or copied to an SD card.

The DVD or SD card containing AVCHD files must have a proper file and folder structure meeting AVCHD format specifications. Please use AVCHD compliant device / software to burn or copy AVCHD files to DVD or SD card. (Please refer to user manuals of your device / software for more information.)

MP3 / WMA

- Sampling frequency: 32 kHz, 44.1 kHz or 48 kHz
- Constant bit rate: 112 kbps - 320 kbps (MP3),
48 kbps - 192 kbps (WMA)

WAV

BD/DVD/USB

- Sampling frequency: 8kHz, 11.025kHz, 12kHz, 16kHz,
22.05kHz, 24kHz, 32kHz,
44.1kHz, 48kHz, 64kHz, 88.2kHz,
96kHz, 176.4kHz, 192kHz
- Quantization bit rate: 8bit, 16bit, 24bit

CD

- Sampling frequency: 8kHz, 11.025kHz, 12kHz, 16kHz,
22.05kHz, 24kHz, 32kHz,
44.1kHz, 48kHz, 64kHz, 88.2kHz,
96kHz
- Quantization bit rate: 8bit, 16bit, 24bit

JPEG

Resolution

- Upper limit: 4,096 x 4,096 dots
(sub sampling is 4:4:4)
5,120 x 5,120 dots
(sub sampling is up to 4:2:2 or 4:2:0)
- Lower limit: 32 x 32 dots
- Maximum file size of a picture: 12 MB

■ Hierarchy / Folder / File Number Limitations

Blu-ray Disc™, DVD and USB flash drive

- 9 hierarchies, 999 folders (groups) and 9,999 files.

CD

- 9 hierarchies, 255 folders (groups) and 999 tracks / files.

Caution / Note for USB flash drive

⚠ Caution

- TEAC is not responsible if the USB flash drive is not supported nor is it responsible for damage or loss of data from the device.
- Do not try to open or modify the USB flash drive.
- Do not touch the terminal surface with your fingers or any metals.

📌 Note

- This unit supports USB flash drives with FAT16 / FAT32 file system.
- This unit does not support the NTFS file system.
- This unit may not read USB flash drives formatted on a computer. If that is the case, please reformat the USB flash drives in this unit and try again.
- Please keep the USB flash drives in their cases when you are not using them.
- Some USB flash drives may not work with this unit.
- This unit can read SD cards using USB card reader / USB hub (not supplied).
 - Readable cards: SD Memory Card (8 MB - 2 GB)
miniSD Card (16 MB - 2 GB)
microSD Card (256 MB - 2 GB)
SDHC Memory Card (4 GB - 32 GB)
miniSDHC Card (4 GB - 8 GB)
microSDHC Card (4 GB - 16 GB)
 - Readable files: AVCHD / MP3 / WMA / WAV / JPEG
- Depending on a USB card reader or USB hub, connected card or device may not be recognized.







■ Unplayable Discs and Files

The following discs will not be played back in this unit.

- CD-ROM
- CD-I (compact disc-interactive)
- DVD-RAM
- VSD (video single disc)
- DVD-audio
- video CD
- HD DVD
- SVCD
- SDXC Memory Card
- microSDXC Memory Card
- unfinalized disc
- BD-R/BD-RE (Recorded in BDAV format)
- Cartridge Type Disc
- Blu-ray Disc™ / USB flash drive that contains AVCHD files
- Blu-ray Disc™ / DVD hybrid disc (played back as a BD-video only)
- DVD-RW/-R recorded in non compatible recording format
- Super Audio CD - Only the sound on the CD layer can be heard. The sound on the high-density Super Audio CD layer cannot be heard.
- Playability of dual discs is not guaranteed.
- This unit cannot play back the disc contents protected by Windows Media™ Digital Rights Management (DRM).

■ Region Codes

This unit has been designed to play back BD-video and DVD-video with region codes as listed below. You cannot play back BD-video or DVD-video that are labeled for other regions. Look for the symbols on your BD-video or DVD-video. If these region symbols do not appear on your BD-video or DVD-video, you cannot play back the disc in this unit. The letter or number inside the globe refers to region of the world. A BD-video or DVD-video labeled for a specific region can only be played back in the unit with the same region code.

DVD-video		BD-video	Countries
			U.S.A and Canada
			Europe

■ Hint for Disc Playback

The contents of a disc are generally divided into sections or folders (groups of titles / files) as shown below.

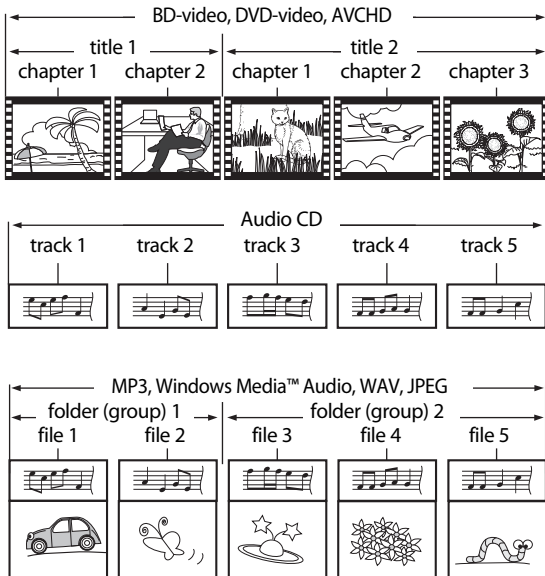

■ Description for Icons

[] : group (folder) icon

[] : music file icon

- "Folders" refers to the groups of files.
- "Tracks" refers to the contents recorded on the audio CD.
- "Files" refers to the contents on a disc which are recorded in MP3, WMA, WAV, JPEG file format.

📌 Note

- Unrecognizable characters will be replaced with "*".

Guide to File List

■ Music File List

e.g.) MP3/WMA/WAV mode

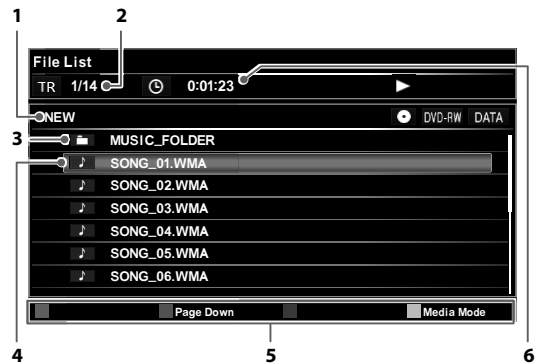

1. Folder name (current directory)

- For the first directory, the disc/device name is displayed.

2. Current file number/total number of files

3. Folder icon

4. File/Folder currently being selected

5. Operation guide

6. Elapsed time

📌 Note

- Folders and files are sorted in alphabetical/numerical order and files are played in that order.

Picture File List

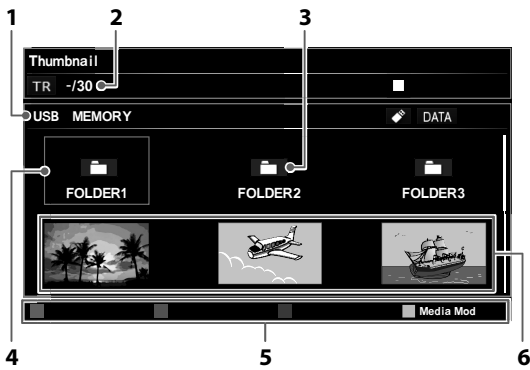

1. Folder name (current directory)

- For the first directory, the disc/device name is displayed.

2. Current file number/total number of files

3. Folder icon

4. File/Folder currently being selected

5. Operation guide

6. Thumbnails

How to Navigate through the Track / File List

- Use [**▲** / **▼**] to move the highlight up and down in the list.
- To access the files in a group (folder), select the desired group (folder), then press [**ENTER**].
- Press [**◀**] or [**RETURN**] to go back to the previous hierarchy.
- Press [**RED**] or [**GREEN**] to change the page of the list.
- Press [**YELLOW**] to go back to the media mode screen.
- Press [**HOME**] to exit.

How to Insert a Disc

1. Press [**OPEN/CLOSE ▲**] to open the disc tray.
2. Place the disc on the disc tray with its label side facing up.

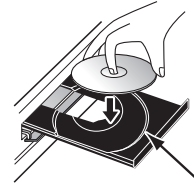

Align the disc to the disc tray guide.

3. Press [**OPEN/CLOSE ▲**] to close the disc tray.
 - It may take a while to load the disc.

9 BASIC PLAYBACK

Playing Back a Disc



1. Insert a disc (refer to "How to Insert a Disc" on page 28).
 - For Blu-ray Disc™ / DVD / audio CD or a disc containing only one type of file, playback will start automatically. If not, press [▶ (play)].
 - Some discs may show a title or a disc menu. In this case, refer to "Using the Title / Disc / Pop-up Menu" on page 31.
2. Select the file type you want to play back, then press [ENTER].
e.g.)

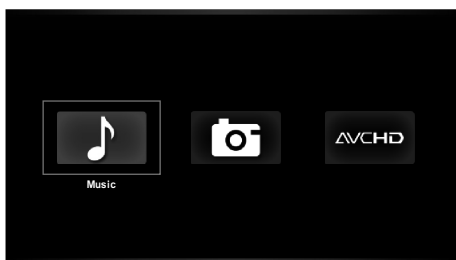

3. For "AVCHD", playback will start automatically.
For "Music", track / file list will be displayed. Select a group (folder) or track / file you want to play back, then press [▶ (play)] or [ENTER] to start playback.
 - Refer to "Music File List" on page 27 and "How to Navigate through the Track / File List" on page 28.For "Photo", thumbnail screen will appear.
 - Refer to "Picture File List" on page 28 and "How to Navigate through the Track / File List" on page 28.

To skip to the next track / file:

Press [▶▶] (skip).

To return to the beginning of the current track / file or to skip to the previous track / file:

Press [◀◀] (skip).

To pause playback:

Press [⏸] (pause).

To return to the normal playback:

Press [▶ (play)].

To stop playback:

Press [■] (stop).

Playback will be in Resume-On-Stop mode.

■ Resume-On-Stop Mode

Blu-ray Disc™ / DVD / AVCHD:

When you press [▶ (play)] next time, the playback will start from the point where it has been stopped.

Audio CD:

Playback will start from the point where it is stopped next time you press [▶ (play)].

If you press [ENTER] instead of [▶ (play)], playback will start from the beginning of the track / file instead of resuming from the stop point.

MP3 / WMA / WAV / JPEG:

Playback will start from the beginning of the current file next time you press [▶ (play)] or [ENTER].

📌 Note

- Playback will also stop and the home menu will appear when you press [HOME].
- For BD-Java application, the Resume-On-Stop may not be available.
- If you press [ENTER] instead of [▶ (play)], playback can be started from the beginning of the disc even if it was in the Resume-On-Stop mode.
- Resume-On-Stop mode remains in effect even after power is turned off, but will be canceled once the disc is ejected.
- With regard to the multi-border BD-RE/-R, additionally recorded sections cannot be recognized.
- With regard to the multi-border DVD-RW/-R, additionally recorded sections may not be recognized.

📌 Note for JPEG Playback

- Every press of [◀▶] will turn the image by 90 degrees when an image is displayed.
- During playback, press [TOP MENU] to display thumbnail screen.
- Some unplayable folders or files may be listed due to the recording status.
- High-resolution JPEG files take longer to be displayed.
- Progressive JPEG files (JPEG files saved in progressive format) cannot be played back in this unit.

Playing Back a DVD-VR Disc



When a playlist has been created on a DVD-RW/-R recorded in VR mode, you can choose "Original" or "Playlist" to play back.

1. Insert a DVD-VR Disc.
 - Refer to "How to Insert a Disc" on page 28.
 - Title list will be displayed.

■ Title list

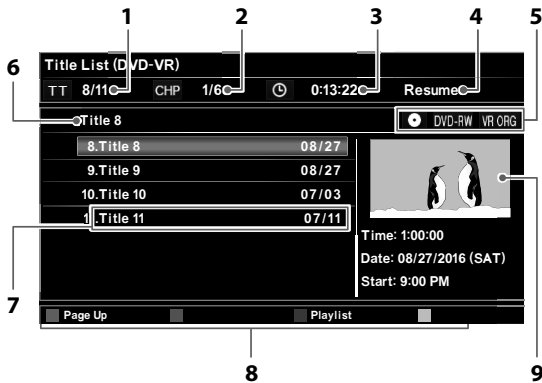

1. **Current title number / Total number of titles**
 2. **Current Chapter number / Total number of chapters**
 3. **Elapsed playing time**
 4. **Playback status**
 5. **Media type**
 6. **Title name currently being selected**
 7. **Title name / Recorded date**
 8. **Operation guide**
 9. **Preview of the title currently being selected**
2. Use [▲/▼] to select a title, then press [▶ (play)] or [ENTER] to start playback.

To pause playback:

Press [⏸ (pause)].

To return to normal playback:

Press [▶ (play)].

To stop playback:

Press [■ (stop)].

- Playback will be in Resume-On-Stop mode, and the title list will appear.

■ Resume-On-Stop Mode

When you press [▶ (play)] next time, the playback will start from the point where it has been stopped.

■ How to switch the Title list between Original and Playlist

Press [BLUE] in the Title list.

Playing Back a USB Flash Drive



You can play back MP3 / WMA / WAV / JPEG files in a USB flash drive. With the USB flash drive, you can also enjoy the following functions.

- Special additional contents for BD-ROM Profile 1 ver.1.1. (For more information about the special additional contents, refer to the instruction book that came with the disc.)
- BD-Live™ function (BD-ROM ver. 2 Profile 2.0). (For more information about BD-Live™, refer to page 34.)

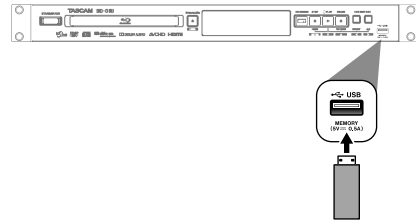

1. Connect a USB flash drive.
2. Press [HOME].
3. Use [◀/▶] to select "USB", then press [ENTER].
 - If a USB card reader or USB hub is connected, drive selection screen appears. Use [◀/▶] to select a drive you want to access, then press [ENTER].
4. Follow steps 2 to 3 in "Playing Back a Disc" on page 29.

To remove the USB flash drive

In stop mode, pull it out slowly.

⚠ Caution

- Do not remove the USB flash drive or switch the unit to the standby mode while the contents of the drive are being accessed. It may result in malfunction or loss of the drive's data.
- TEAC cannot be held responsible if your USB flash drive is not supported, nor will TEAC accept any liability for damage or loss of stored data.
- If you connect SD card or USB flash drive via USB card reader or USB hub, BD-ROM data will be write onto the first connected card or device. Connecting a USB flash drive directly to this unit is recommended.
- Do not use the USB port on this unit to charge the battery on a USB device.

📌 Note

- The resume information will be cleared when;
 - **[■ (stop)]** is pressed while in the Resume-On-Stop mode.
 - the USB flash drive is removed.
 - the unit is switched to standby mode.
- Do not delete the folders or files in the USB flash drive with your computer. This unit may not read USB flash drives formatted on a computer.
- If a folder or file name includes one of the following unrecognizable characters, the folder or file name may not be displayed correctly.
 - Unrecognizable characters:

., " = + [] ; / \ : ¥

- This unit can read MP3 / WMA / WAV / JPEG files and AVCHD on an SD card by using USB card reader / USB hub (not supplied).

Using the Title / Disc / Pop-up Menu



Some BD-videos, DVD-videos or AVCHD files may contain a title menu which describes the contents of the disc, or a disc menu which guides you through the available functions in the disc.

With such discs, a title menu or a disc menu may appear automatically when you insert the disc. Otherwise, press **[TOP MENU]** or **[POP UP/MENU]** to call up the menu. Refer to the disc's manual on how to navigate through the menu.

📌 Note

- Menus vary among discs. Refer to the information accompanying the disc for details.
- **[TOP MENU]** or **[POP UP/MENU]** may not work with some discs.

10 SPECIAL PLAYBACK

Fast Forward / Fast Reverse



1. During playback, press [▶▶ (forward)] repeatedly for fast forward.
During playback, press [◀◀ (reverse)] repeatedly for fast reverse.
Every time you press [▶▶ (forward)] or [◀◀ (reverse)], the playback speed will change.
2. Press [▶ (play)] to return to normal playback.

Note

- For Blu-ray Disc™, DVD and AVCHD, speed changes in 5 different levels.
- For audio CD, MP3, WMA, and WAV, speed changes in 3 different levels.
- For audio CD, MP3, WMA, and WAV, fast forward / fast reverse search between different files or tracks are not available.

Fast Playback with Audio



1. During playback, press [▶ (play)].
 - Playback will be performed approximately at 1.3 times the normal playback speed while outputting the audio.
 - To return to normal playback, press [▶ (play)] again.

Slow Forward Playback



1. During playback, press [⏸ (pause)]. Then press [▶▶ (forward)].
Every time you press [▶▶ (forward)], the playback speed changes in 3 different levels.
2. Press [▶ (play)] to return to normal playback.

Note

- Only slow forward is available.
- Set “Still Mode” setting to “Field” in “Video Out” menu if pictures in the slow forward playback mode are blurred.

Frame by Frame Playback



1. In pause mode, press [⏸ (pause)] repeatedly.
Every time you press [⏸ (pause)], playback will advance one frame at a time.
2. Press [▶ (play)] to return to normal playback.

Note

- Only frame by frame forward is available.
- Set “Still Mode” setting to “Field” in “Video Out” menu if pictures during frame by frame playback mode is blurred.

Instant Replay



1. During playback, press [INSTANT REPLAY].
 - Every press of [INSTANT REPLAY] reverses the playback by the amount of time specified in “Settings” → “Playback” → “Instant Replay” (p.40).































Note

- If [INSTANT REPLAY] is pressed during Fast Forward/ Fast Reverse/Slow Forward, the playback speed will return to normal when the playback comes to the Instant Replay destination.

Repeat Playback

Available repeat function varies depending on the discs.

1. During playback, press **[REPEAT]**.
2. Use **[▲/▼]** to select the desired repeat mode.

Repeat Mode	Available Media
Chapter Repeat 	  
The current chapter will be played back repeatedly.	
Title Repeat 	  
The current title will be played back repeatedly.	
Track Repeat 	  
The current track or file will be played back repeatedly.	 
All Repeat 	 
All titles/tracks in the media will be played back repeatedly.	
Folder Repeat 	  
The current folder will be played back repeatedly.	
Random Repeat (Audio CD) 	
Repeats the random playback.	
Random Repeat (MP3 / WMA / WAV / JPEG) 	  
Repeats the random playback in a folder.	

3. Press **[RETURN]** to exit.

Note

- The repeat setting will be canceled when you stop playback.
- When the repeat setting is set for a MP3, WMA, or WAV folder (file), the repeat setting will be canceled if you select other MP3, WMA, or WAV folder (file) to play back.
- The repeat setting will be canceled when the unit is turned off.

A-B Repeat



You can play back the specific part (between point A and point B) repeatedly.

1. During playback, press **[A-B]** at the desired starting point A.
2. During playback, press **[A-B]** at the desired ending point B.
As soon as you set the point B, the part between point A and point B will start playback repeatedly.
 - To cancel the A-B repeat, press **[A-B]** again or **[REPEAT]**.

Note

- Point B should be set within the same title or track as point A.
- A-B repeat is not available with some scenes.
- To cancel the A point which was set, press **[REPEAT]**.

Caution

- The following operations will clear the settings of the Repeat Playback and A-B Repeat functions.
 - Turning off this unit
 - Displaying the Title/File List
- The following operations will clear the settings of the Repeat Playback and A-B Repeat functions, when their results will exceed the repeat range.
 - Skip
 - Chapter/Track/Time search
 - Instant Replay

Slide Show



1. Follow steps 1 to 2 in "Playing Back a Disc" on page 29.
2. Open the folder which contains the desired JPEG files.
3. Use **[▲/▼/◀/▶]** to select a desired file to be played back, then press **[▶ (play)]** or **[ENTER]**.
 - An image will be played back from the selected file and go to the next one in turn every 10 seconds.
4. Press **[■ (stop)]** to stop playback.

To return to the first item:

Press **[TOP MENU]**.

To return to the file played last:

Press **[POP UP/MENU]**.

Note

- Large-size JPEG files take a few moments to be displayed.

PiP (BONUSVIEW™) Setting



Some BD-videos have the Picture-in-Picture function which enables you to display the secondary video in the primary video.

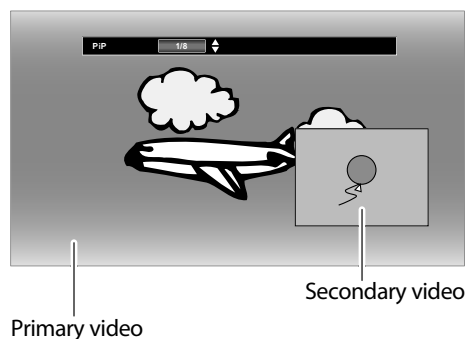

1. During playback, press **[MODE]**.
2. Use **[▲ / ▼]** to select "PiP", then press **[ENTER]**.
3. Use **[▲ / ▼]** to select the secondary video you want to show.
 - The secondary video will be displayed with the secondary audio.
 - Use **[◀ / ▶]** to switch between current setting and "Off".
 - On how to output the secondary audio, refer to "Switching Audio Soundtrack" on page 36.

Note

- The PiP setting will remain even if this unit is turned off.

Using BD-Video Virtual Package



BD-Video, which supports Virtual Package, allows you to enjoy a variety of playback functions by copying data to the USB flash drive. In order to use Virtual Package, connect a USB flash drive to the unit in advance.

- A USB flash drive with other data stored on it or formatted on another device may not work properly with BD-Video playback. In such cases, perform "Format USB" on this unit. (p.47)
- If the USB flash drive with data for Virtual Package playback is disconnected during BD-Video playback, the playback will stop.
- The audio and/or video may stop during BD-Video playback.
- To erase data for Virtual Package on a USB flash drive, perform "(USB) Erase Saved BD-ROM Data". (p.47)

Enjoying BD-Live™ Discs Using the Internet



BD-Live™ enables you to use interactive features when the unit is connected to the Internet.

Examples of BD-Live™ features:

- Online access to additional content such as movie trailers, subtitles, BD-Java applications, etc.
- While downloading, special video data may be played back.
 - **Service and functions differ depending on the disc. Follow the instructions given by the disc when using the BD-Live™ function.**
 - **Connect USB flash drive of at least 1 GB capacity before using BD-Live™ features on a Blu-ray Disc™.**
 - **Do not remove the USB flash drive while using BD-Live™ features.**

Note

- You must connect the unit to the Internet and set up necessary settings in order to use BD-Live™.
- For the network connection, refer to "Connection to the Network" on page 22.
- For the network setup, refer to "Network Connection" on page 41.
- For certain discs, "BD-Live Setting" in "Network" Setup may need to be changed. (Refer to page 40.)
- Depending on your connection environment, it may take time to connect to the Internet or the Internet may not be connected.
- When BD-Live™ functions are used and the unit is connected to the Internet, you may be charged for this communication.
- Some discs with BD-Live™ function require memory when playing back the content. If you cannot play back a disc with BD-Live™ function, connect USB flash drive (1 GB or more) which is formatted on this unit.

Note for AACs Online

- The player or disc IDs may be sent to the content provider when playing back a disc with BD-Live™ function.
- If you save your viewing history on the server by using these IDs, you will be introduced to other similar movies.

Title / Chapter Search



■ Using [◀◀ (skip)] / [▶▶ (skip)]

1. During playback, press [▶▶ (skip)] to skip the current title or chapter and move to the next.
The title or chapter will move forward one at a time.
 - If there is no chapter in one title, the current title may be skipped.To go back to the beginning of the current title or chapter, press [◀◀ (skip)].
Press [◀◀ (skip)] repeatedly to go to the previous title or chapter. The title or chapter may move backward one at a time.

■ Using [SEARCH]

1. During playback, press [SEARCH].
2. Use [▲/▼] to select "TT" or "CHP", then press [ENTER].
e.g.) Blu-ray Disc™



3. Use [▲/▼/◀/▶] to select the title / chapter number.
4. Press [ENTER].
Playback will start from the beginning of the title / chapter.

📌 Note

- You can also search from the play menu. Play menu can be called up by pressing [MODE].

■ Using [the Number buttons] (Direct Search)

Chapter Search

During playback, enter the chapter number you want to search using [the Number buttons]. Playback of the chapter will start in a few seconds.

📌 Note

- As for the BD-video, how it performs will be strongly determined by the disc, and may not perform as described.



Track Search



1. During playback, press [▶▶ (skip)] to skip the current track or file and move to the next.
The track / file will move forward one at a time. To go back to the beginning of the current track / file, press [◀◀ (skip)].
Press [◀◀ (skip)] repeatedly to go to the previous track / file. The track / file will move backward one at a time.

Time Search

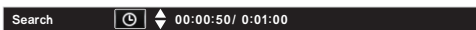

1. During playback, press [SEARCH].
2. Use [▲/▼] to select "⌚", then press [ENTER].
e.g.) Blu-ray Disc™

3. Use [the Number buttons] or [▲/▼] to enter the time count you want to jump to.
e.g.) Entering 1 hour 45 minutes and 15 seconds.

4. Press [ENTER].
Playback will start from the desired time entered.

📌 Note

- You can also search from the play menu. Play menu can be called up by pressing [MODE].

Power On Play



This unit has a function called "Power On Play" which automatically starts disc playback (BD-video/DVD-video/audio CD) when the unit is turned on or plugged in.

To enable this function, perform the following:

1. Press [HOME], then select "Settings" → "Others" → "Power On play" → "On".
 - If the disc in the unit for Power On Play is an audio CD, it will be played in Repeat-All mode.

📌 Note

- When this function is enabled, buttons other than [⏻/|] (STANDBY/ON) and [▲] (OPEN/CLOSE) will not be accepted.
- Once the disc tray opens, this function will be disabled. To re-enable it, turn Off the unit then turn it back On, or unplug the AC cord then plug it back in.
- If the unit is turned off while "Power On play" is activated, the playback will be resumed when the unit is turned back on from the point where the unit was turned off.
- In the case that a DVD-VR disc or a disc containing an MP3/WMA/WAV file(s) is inserted while "Power On Play" is activated, the disc will automatically be played when the unit is turned on. However, button operations are enabled and the repeat functions are disabled.

Switching Subtitles

Some video materials may have subtitles in one or more languages. For commercially available discs, the supported languages can be found on the disc case. Follow the steps below to switch the subtitle language during playback.

BD-V

1. During playback, press **[SUBTITLE]**.
2. Use **[▲/▼]** to select "Primary", "Secondary" or "Style", then press **[ENTER]**.

"Primary": Sets the subtitle for the primary video.

"Secondary": Sets the subtitle for the secondary video.

"Style": Sets style of the subtitle.

3. Use **[▲/▼]** to select your desired subtitle or style.

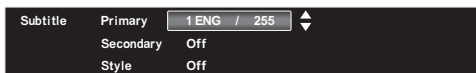

- Use **[◀/▶]** to switch between current subtitle setting and "Off".

DVD-V

DVD-VR

AVCHD

1. During playback, press **[SUBTITLE]**.
2. Use **[▲/▼]** to select your desired subtitle.



- Use **[◀/▶]** to switch between current subtitle setting and "Off".

Note

- Some discs will only allow you to change the subtitles from the disc menu or pop-up menu. Press **[TOP MENU]** or **[POP UP/MENU]** to display the disc menu or pop-up menu.
- If the disc has no subtitle language or subtitle style, "Not Available" will be displayed on the TV screen.
- During playback of the secondary video, the primary subtitle setting is not available except when there is no subtitle for the secondary video.
- You can also change the subtitle setting from the play menu. Play menu can be called up by pressing **[MODE]**.
- The Subtitle setting will remain even if this unit is turned off.

Switching Audio Soundtrack

When playing back video material recorded with two or more soundtracks (these are often in different audio languages or audio formats), you can switch them during playback. For Blu-ray Disc™, available audio varies depending on "BD Audio Mode" setting.

BD-V

1. During playback, press **[AUDIO]**.
2. Use **[▲/▼]** to select "Primary" or "Secondary", then press **[ENTER]**.
"Primary": Sets the audio for the primary video.
"Secondary": Sets the audio for the secondary video.
3. Use **[▲/▼]** to select your desired audio stream channel.

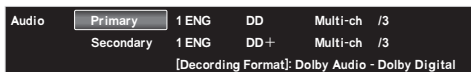

- For "Secondary", use **[◀/▶]** to switch between current audio setting and "Off".

DVD-V

DVD-VR

AVCHD

1. During playback, press **[AUDIO]**.
2. Use **[▲/▼]** to select your desired audio stream channel.

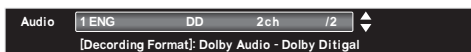

CD

1. During playback, press **[AUDIO]**.
2. Use **[▲/▼]** to select your desired setting from the following options:
"Stereo": Both right and left channels are active (stereo).
"L-ch": Only left channel is active.
"R-ch": Only right channel is active.

Note

- The secondary audio will not be output when the secondary video is not displayed or when "BD Audio Mode" is set to "HD Audio Output". (For some Blu-ray™ discs, secondary audio will be output even when secondary video is off.)
- The sound mode cannot be changed during playback of discs not recorded in multiple audio mode.
- Some discs allow changing the audio language setting on the disc menu. (Operation varies depending on the discs. Refer to the manual accompanying the disc.)
- **[AUDIO]** may not work on some discs with multiple audio streams or channels (e.g. DVDs that allow changing audio setting on the disc menu).
- If the disc has no audio language, "Not Available" will be displayed on the TV screen.
- For DTS-CD (5.1 music disc), selecting audio streams or channels are not available.
- You can also change the audio setting from the play menu. Play menu can be called up by pressing **[MODE]**.
- The Audio setting will remain even if this unit is turned off.

Switching Camera Angles



Some BD-videos and DVD-videos contain scenes which have been shot simultaneously from various angles. You can change the camera angle when  appears on the TV screen.

1. During playback, press **[MODE]**.
2. Use **[▲/▼]** to select "Angle", then press **[ENTER]**.
 - The selected angle will be displayed on the display bar at the top of the TV screen.
3. Use **[▲/▼]** to select your desired angle.

Note

- If "On Screen Guide" setting is set to "Off",  will not appear on the TV screen.
- The Angle setting will remain even if this unit is turned off.

Noise Reduction of the Playback Picture



You can reduce the noise of the playback picture.

1. During playback, press **[MODE]** to display the play menu.
2. Use **[▲/▼]** to select "Noise Reduction", then press **[ENTER]**.
3. Use **[▲/▼]** to select your desired setting.
 - "On": Activates noise reduction.
 - "Off": Deactivates noise reduction.

Note

- The Noise Reduction setting will remain even if this unit is turned off.

Super Resolution



Super Resolution reduces image deterioration when outputting low-resolution images in high resolution.

1. During playback, press **[MODE]** to display the play menu.
2. Use **[▲/▼]** to select "Super Resolution", then press **[ENTER]**.
3. Use **[▲/▼]** to select your desired setting.
 - "On": Gives low-definition videos high-definition like picture quality.
 - "Off": Shows the original picture as recorded.

Note

- This operation is prohibited during Fast Forward, Fast Reverse, Slow Forward playback and pause mode.
- Pictures may appear whiter depending on the material and the connected TV. In this case, turn "Super Resolution" Off.
- "Super Resolution" is not effective under the following conditions.
 - When the material is in 1080p/24 which is commonly used in Blu-ray discs.
- The Super Resolution setting will remain even if this unit is turned off.

11 LIST OF SETTINGS

In the setup menu, you can customize various settings as you prefer. Refer to the following instructions to navigate through the setup menu.

1. Press **[HOME]** to access the home menu.
2. Use **[◀/▶]** to select "Settings", then press **[ENTER]**.
3. Use **[▲/▼]** to select the desired setting, then press **[ENTER]**.
4. Use **[▲/▼]** to move the highlight up and down in the list.
5. To make a selection or to access options of an item, select the desired item, then press **[ENTER]**.
 - To go back to the previous screen, press **[RETURN]**.
6. Press **[HOME]** to exit.

Refer to the following table for the types of settings you can customize. The item highlighted in gray is the default setting.

Category	Menus / Options		
Video Out	TV Aspect	16:9 Wide	
		16:9 Squeeze	
		4:3 Letter Box	
		4:3 Pan & Scan	
	Still Mode	Auto	
		Field	
Frame			
Audio Out	DRC	Auto	
		On	
		Off	
	Digital Output *1	Bitstream	
		LPCM	
	Downsampling	On	
		Off	
	BD Audio Mode	HD Audio Output	
		Mix Audio Output	
	Attenuation	0dB	-7dB
		-1dB	-8dB
		-2dB	-9dB
		-3dB	-10dB
		-4dB	-11dB
-5dB		-12dB	
-6dB			
HDMI	Video Resolution	Auto	
		480p/576p *2	
		720p	
		1080i	
		1080p	
		1080p/24	
	HDMI CEC	On	
		Off	
	Audio Output	Bitstream	
		LPCM	
		Off	
	Deep Color *3	Auto	
		Off	
	Progressive Mode	Auto	
		Video	
	HDCP Auto	On	
		Off	

*1 Only available when "HDMI" → "Audio Output" is set to "Off".

*2 576p: For Europe model.

*3 Only available when the connected HDMI-compliant device supports Deep Color.

Category	Menus / Options		
Playback	Player Menu *4	Auto	Español
		Deutsch	Français
		English	Italiano
	Audio	Original	
		Bulgarian	Italian
		Chinese	Japanese
		Czech	Korean
		Danish	Norwegian
		Dutch	Polish
		English	Portuguese
		Finnish	Romanian
		French	Russian
		German	Slovak
		Greek	Spanish
		Hungarian	Swedish
		Icelandic	Turkish
	Irish	Other	
	Subtitle	Off	
		Bulgarian	Italian
		Chinese	Japanese
		Czech	Korean
		Danish	Norwegian
		Dutch	Polish
		English	Portuguese
		Finnish	Romanian
		French	Russian
		German	Slovak
Greek		Spanish	
Hungarian		Swedish	
Icelandic		Turkish	
Irish	Other		

*4 Player Menu differs depending on your country.

Category	Menus / Options		
Playback	Disc Menu	Bulgarian	Italian
		Chinese	Japanese
		Czech	Korean
		Danish	Norwegian
		Dutch	Polish
		English	Portuguese
		Finnish	Romanian
		French	Russian
		German	Slovak
		Greek	Spanish
		Hungarian	Swedish
		Icelandic	Turkish
		Irish	Other
		BD Rating Level *5	Off
	DVD Rating Level *5	Age Setting	
		Off	4 [PG-13]
		8 [Adult]	3 [PG]
		7 [NC-17]	2 [G]
		6 [R]	1 [Kid Safe]
	Instant Replay	5 seconds	
10 seconds			
30 seconds			
1 minute			
5 minutes			
On Screen Guide	On		
	Off		
Panel Display	Auto		
	Bright		
	Dimmer		
Network	Network Connection	Start	
		Connection Test	
	Network Status		
	BD-Live Setting	Allow	
Limited Allow			
Prohibit			
Others	Power On Play	On	
		Off	
	Power On Control	Enable	
		Disable	
	Password Change		
	Product Info		
	Software Update	USB	
		Disc	
	Initialize	Reset Settings	
		Reset Network Settings	
		(Unit) Erase Saved BD-ROM Data	
		(USB) Erase Saved BD-ROM Data	
	Format USB		
Auto Power Off *6	On		
	Off		
Screen Saver	On		
	Off		
OSS			

*5 Password will be requested. (p.45)

*6 The default setting of "Auto Power Off" differs between the USA/Canada and Europe model as follows:
 USA/Canada model: Off
 Europe model: On

12 PLAYER SETUP

Network Connection

[HOME] → "Settings" → "Network" → "Network Connection"

Set up network connection settings in order to use BD-Live™.

■ Auto

Select "Auto" to set the network setting automatically.

1. Use [◀/▶] to select "Settings" in the home menu, then press [ENTER].
2. Use [▲/▼] to select "Network", then press [ENTER].
3. Use [▲/▼] to select "Network Connection", then press [ENTER].
4. Use [▲/▼] to select "Start", then press [ENTER].
5. Use [▲/▼] to select "Auto", then press [ENTER].
 - The unit will start the connection test automatically and the test result will appear right after the test finishes.

"Connecting...": The test is in progress.

"Pass": Network connection succeeds.

"Failed": Network connection failed.

6. The network setting is completed. Select "Finish".

■ Manual

In the following cases, select "Manual" to set each setting as necessary.

- When connection test failed with the setting of "Auto".
 - When instructed by your Internet service provider to make specific settings in accordance with your network environment.
1. Use [◀/▶] to select "Settings" in the home menu, then press [ENTER].
 2. Use [▲/▼] to select "Network", then press [ENTER].
 3. Use [▲/▼] to select "Network Connection", then press [ENTER].
 4. Use [▲/▼] to select "Start", then press [ENTER].
 5. Use [▲/▼] to select "Manual", then press [ENTER].
 6. Use [▲/▼] to select "IP Address", then press [ENTER].

7. IP address setting screen will appear. Enter IP address with cursor buttons and number buttons.

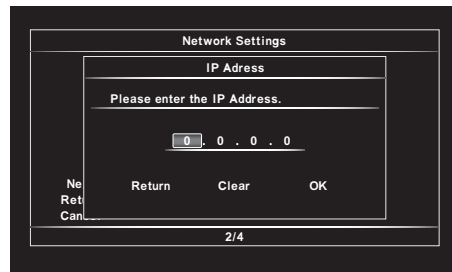

- Enter the IP address after checking the specifications of your router.
 - If the IP address is unknown, check the IP address of other devices. (e.g. PC connected via LAN cable) and assign a different number from those of other devices.
8. Use [▲/▼/◀/▶] to select "OK", then press [ENTER].
 9. Select "Subnet Mask", "Default Gateway", "Primary DNS" and "Secondary DNS" in turn, and enter each address number with cursor buttons and number buttons, then press [ENTER].
 - Enter the DNS addresses provided by your Internet provider.
 - If the DNS address is unknown, check the DNS address of other devices (e.g. PC connected via LAN cable) and assign the same DNS address.

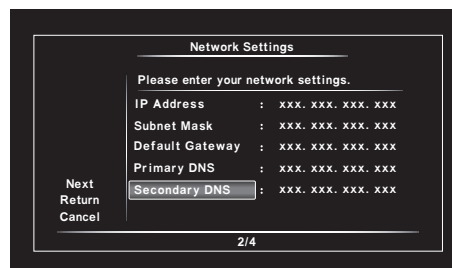

10. Use [▲/▼/◀/▶] to select "OK", then press [ENTER].
11. Use [◀] to select "Next", then press [ENTER].
12. Use [▲/▼] to select "Yes" or "No" for proxy server, then press [ENTER].
 - If you use proxy server, select "Yes" to go to the next step.
 - If you do not use proxy server, select "No" to go to step 13.

- Proxy address setting screen will appear. Enter proxy address with cursor buttons, number buttons and color buttons.

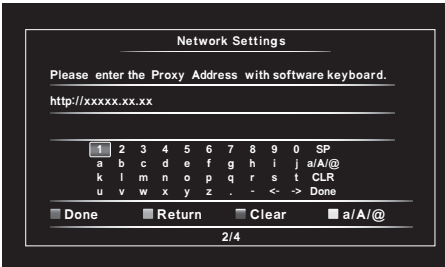

- [▲/▼/◀/▶]:** Moves the highlight.
- [the Number buttons]:** Enters number.
- “Done” / [ENTER]:** Enters the highlighted number or letter.
- [RED]*:** Sets the entered number or letter.
- [GREEN]:** Exits the network setting.
- “CLR” / [BLUE]:** Clears the entered number or letter.
- “a/A/@” / [YELLOW]*:** Switches between abc, ABC and symbols (e.g. @!?).
- “SP”:** Inserts a space.

* These buttons can be used in other network settings.

- Press **[RED]** to go to the proxy port setting screen. Enter proxy port number with number buttons.

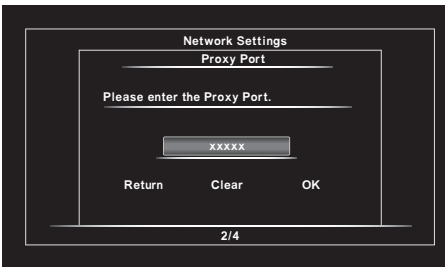

- Use **[▲/▼/◀/▶]** to select “OK”, then press **[ENTER]**.
- The connection test confirmation screen will appear. Select “Yes” to start the connection test and the test result will appear right after the connection test finishes.
- Select “Finish” to complete the settings.

■ Connection Test

After you enable a network connection or change the network settings, always perform the connection test to check if the connection is correctly made.

- Use **[◀/▶]** to select “Settings” in the home menu, then press **[ENTER]**.
- Use **[▲/▼]** to select “Network”, then press **[ENTER]**.
- Use **[▲/▼]** to select “Network Connection”, then press **[ENTER]**.
- Use **[▲/▼]** to select “Connection Test”, then press **[ENTER]**.
 - Connection test will start automatically and the test result will appear right after the connection test finishes.
- If the connection test passes, press **[ENTER]**.

Note

- If the connection test passes, you are ready to use BD-Live™, using the Internet without making any additional settings.
- If the connection test fails, you may need to check your router settings and make sure the physical connection is secure. If you need the MAC address of this unit to complete your router settings you can view it on the “Network Status” screen (refer to page 40).
- When connecting this unit directly to a modem for the first time or connecting it to a modem which was previously connected to any other network device (e.g. a router, PC, etc.), you may have to power cycle the modem to reset the settings on the modem.

Note for “IP Address”, “Subnet Mask”, “Default Gateway”, “Primary DNS” and “Secondary DNS”

- The range of input numbers is between 0 and 255.
- If you enter a number larger than 255, the number will automatically be 255.
- When you enter a wrong number, select “Clear” to clear. (The number will be back to “0”.)
- If you want to enter a 1 or 2-digit number in one cell, press [▶] to move on to the next cell.

Note for “Proxy Address” and “Proxy Port”

- The range of input numbers for the port number is between 0 and 65535. (If you enter a number larger than 65535, it will be regarded as 65535.)
- For proxy port, certain ports might be closed, blocked or unusable depending on your network environment.
- When the settings are changed, the network connection may be disabled depending on the device.

Attenuation

[HOME] → “Settings” → “Audio Out” → “Attenuation”

If noise can be heard in the audio from the ANALOG OUTPUTS jack, it may be reduced by changing the “Attenuation” configuration.

HDMI CEC

[HOME] → “Settings” → “HDMI” → “HDMI CEC”

HDMI CEC allows integrated system control over HDMI and is part of the HDMI standard. This function may not work properly depending on the device connected to the unit. When “HDMI CEC” setting is set to “On”, functions listed below will be available.

■ One Touch Play

HDMI CEC operations are performed using remote control buttons. The TV will automatically be turned on and switched to the appropriate input source signal.

Buttons for one touch play:

- [▶ (play)], [◀◀ (skip)], [▶▶ (skip)], [the Number buttons], [HOME], or [ON SCREEN]
- [TOP MENU] or [POP UP/MENU] (when a disc is inserted in the unit)

■ One Touch Standby

When you press and hold [⏻/I (STANDBY/ON)] for 2 seconds, it will turn off the power to the TV first and then turn off the power to this unit.

When the connected HDMI CEC compatible display device is turned off first, this unit will be turned off subsequently.

■ System Information

Get & Set Menu Language

The unit recognizes the OSD language set on the TV and automatically sets the same language as the player menu language (OSD menu language) for this unit. Refer to the “Player Menu” on page 39 for available languages.

- This feature is available only when “Auto” is selected in the “Player Menu” section in the setup menu.

Video Resolution

[HOME] → "Settings" → "HDMI" → "Video Resolution"

Set the resolution of the video signal being output from the HDMI OUTPUT jack.

You can select the desired "Video Resolution" among the settings listed below:

"Auto", "480p/576p", "720p", "1080i", "1080p", "1080p/24".

Actual Output Resolution by Media:

Setting in the "Video Resolution"	Source				
	480i/60 576i/60*	720p/60	1080i/60	720p/24	1080p/24
480p/576p*	480p/60 576p/60*				
720p	720p/60				
1080i	1080i/60				
1080p	1080p/60				
1080p/24	1080p/60				1080p/24
Auto	The highest or recommended resolution supported by your display device will be in effect automatically.				

Note

- The selected resolution must also be supported by your display device.
- Even if "Video Resolution" is set to "1080p/24", for a Blu-ray Disc™ that is not recorded in 1080p/24 or for DVD, the video resolution supported by the disc and the display device will be output instead of 1080p/24. Refer also to the manual of your display device.
- Do not remove HDMI cable during playing the video in 1080p/24. Video signals will not be output if you replace the connection to a device which is not compatible with 1080p/24 contents.
- The audio signals from the HDMI OUTPUT jack (including the sampling frequency, the number of channels and bit length) may be limited by the connected device.
- Among the display device(s) that support HDMI, some do not support audio output (for example, projectors). While connected to a device such as a projector, audio will not be output from the HDMI OUTPUT jack.
- When this unit's HDMI OUTPUT jack is connected to a DVI-D compatible display device(s) (HDCP compatible) with an HDMI-DVI converter cable, the signals are output in digital RGB.
- When you make a selection, the TV monitor temporarily goes blank and then comes back again. If it does not come back, press and hold **[PAUSE]** on the front panel for 5 seconds to change the setting back to its default.

* 576i/p: For Europe model.

Copyright protection system

To play back the digital video images of a BD-video or DVD-video via an HDMI connection, it is necessary that both the player and the display device (or an AV receiver / amplifier) support a copyright protection system called HDCP (high-bandwidth digital content protection system). HDCP is copy protection technology that comprises data encryption and authentication of the connected AV device. This unit supports HDCP. Please read the operating instructions of your display device (or an AV receiver / amplifier) for more information.

HDCP Auto

[HOME] → "Settings" → "HDMI" → "HDCP Auto"

This unit can output non-copyrighted videos by setting "HDCP Auto" in "Settings" to "On".

There is a case that images are not output correctly when "HDCP Auto" is set to "Off", and the unit is connected to a non-HDCP-compliant device.

In that case, perform the following:

1. Press and hold [STOP] on the front panel for more than 5 seconds (p.12).
 - "HDCP Auto" will be set to "On".

Parental

The Parental Rating control allows you to set a limit, which prevents your children from viewing inappropriate materials. Playback will be stopped if the rating's exceed the level you set, and it will require you to enter a password before playing back the disc.

1. Use [the Number buttons] to enter your 4-digit password.

For first time use:
Use [the Number buttons] to enter any 4-digit number (except for 4737). That number will be used as the recover password. Record your password, in case you might forget it.

 - If you forget the password, enter [4], [7], [3], [7]. The password will be cleared and rating level will be set to "Off".
 - When you input the password, select "Clear" to clear the number, then re-enter the password.

BD Rating Level

[HOME] → "Settings" → "Playback" → "BD Rating Level"

1. Use [◀/▶] to select "Settings" in the home menu, then press [ENTER].
2. Use [▲/▼] to select "Playback", then press [ENTER].
3. Use [▲/▼] to select "BD Rating Level", then press [ENTER].
4. Use [the Number buttons] to enter your 4-digit password.
5. Use [▲/▼] to select your desired option, then press [ENTER].

"Off" : To release the limitation.

"Age Setting" : To set the age limitation.

- After selecting "Age Setting", use [the Number buttons] to enter the age.
(e.g., For age 6, enter [6] + [ENTER].
For age 15, enter [1], [5] + [ENTER].)
6. Press [HOME] to exit.

DVD Rating Level

[HOME] → "Settings" → "Playback" → "DVD Rating Level"

1. Use [◀/▶] to select "Settings" in the home menu, then press [ENTER].
2. Use [▲/▼] to select "Playback", then press [ENTER].
3. Use [▲/▼] to select "DVD Rating Level", then press [ENTER].
4. Use [the Number buttons] to enter your 4-digit password.
5. Use [▲/▼] to select your desired level, then press [ENTER].
6. Press [HOME] to exit.

RATING EXPLANATION	
Off	Parental Control is inactive; all discs can be played back.
8 [Adult]	DVD software of any grades (adult / general / children) can be played back.
7 [NC-17]	No one under 17.
6 [R]	Restricted; under 17.
5 [PGR]	Parental guidance recommended.
4 [PG-13]	Unsuitable for children under 13.
3 [PG]	Parental guidance suggested.
2 [G]	General audience.
1 [Kid Safe]	Suitable for children.

■ Password Change

[HOME] → "Settings" → "Others" → "Password Change"

1. Use [**◀/▶**] to select "Settings" in the home menu, then press [**ENTER**].
2. Use [**▲/▼**] to select "Others", then press [**ENTER**].
3. Use [**▲/▼**] to select "Password Change", then press [**ENTER**].
4. Use [**the Number buttons**] to enter your 4-digit password.
5. Use [**the Number buttons**] to enter a new 4-digit password.
6. Use [**the Number buttons**] to retype the same new 4-digit password.
7. Press [**HOME**] to exit.

To cancel parental lock temporarily

Some discs allow you to cancel the parental lock temporarily. With those discs, the message below will appear when you try to play them back.

"Enter current password."

Follow the instruction which appears on the TV screen to cancel the parental lock. After entering the password, rating level appears. Select desired rating level, then press [**ENTER**].

Software Update

[HOME] → "Settings" → "Others" → "Software Update"

This unit lets you update the software yourself using a software update disc or USB flash drive. To update the software, you must first download the latest version software to a PC. Then write the update to a disc or USB flash drive, then execute "Software Update".

■ Disc / USB Update

You can update the software by using a disc or USB flash drive.

Prepare a software update disc or USB flash drive:

Access the TEAC Global Site (<http://teac-global.com/>), and download the latest version software to a blank disc or a blank USB flash drive using a PC by following the directions described on the website.

- Use a blank disc or a blank USB flash drive and download one software per disc and USB flash drive.
 - For more details on how to download the software, please refer to the website.
1. Use [**◀/▶**] to select "Settings" in the home menu, then press [**ENTER**].
 2. Use [**▲/▼**] to select "Others", then press [**ENTER**].
 3. Use [**▲/▼**] to select "Software Update", then press [**ENTER**].
 4. Use [**▲/▼**] to select "Disc" or "USB", then press [**ENTER**].
 5. Use [**◀/▶**] to select "Yes", then press [**ENTER**].
 6. Insert the disc or connect the USB flash drive for software update.
 7. After loading disc or USB flash drive, confirmation message will appear. Select "Yes" and press [**ENTER**] to start updating.
 - It may take a while to complete the updating.
 8. After the update finishes, this unit will restart. Remove the disc or USB flash drive from the unit.

⚠ Caution

- Please do not unplug the AC power cord while executing the "Disc / USB Update".

📌 Note

- All settings will remain the same even if you update the software version.

Initialize

[HOME] → "Settings" → "Others" → "Initialize"

Menus to reset player settings, format USB flash drive, local storage and clear network settings.

1. Use [◀/▶] to select "Settings" in the home menu, then press [ENTER].
2. Use [▲/▼] to select "Others", then press [ENTER].
3. Use [▲/▼] to select "Initialize", then press [ENTER].
4. Use [▲/▼] to select the desired setting, then press [ENTER].

"Reset Settings":

All the settings except for the parental lock and network settings will be reset to default.

"Reset Network Settings":

Resets the network setting to the default.

"(Unit) Erase Saved BD-ROM Data":

Clears the data saved for the BD-ROM contents, such as BD-ROM game scores, on this player.

"(USB) Erase Saved BD-ROM Data" (Available only when a USB flash drive is connected.):

Clears the supplemental data for the BD-ROM playback, such as subtitle data, from the USB flash drive.

"Format USB" (Available only when a USB flash drive is connected):

Initialize the USB flash drive.

5. Use [◀/▶] to select "Yes", then press [ENTER].
6. Confirmation message will appear. Press [ENTER] to complete the setting.
7. Press [HOME] to exit.

⚠ Caution

- Do not remove the USB flash drive while executing the "Format USB" or "(USB) Erase Saved BD-ROM Data". It will damage the drive.

📌 Note







- "Format USB" or "(USB) Erase Saved BD-ROM Data" is not available when a Blu-ray Disc™ is in the unit.

13 OTHER FUNCTIONS

Unit Lock

This unit can be locked to disable specified operations from the remote control and the front panel.

- When performing the following steps, [SHIFT] must be held down continuously.
1. Hold [SHIFT] down and press [OPEN/CLOSE].
 - The current lock status will be displayed.
 2. Keep [SHIFT] down and press [OPEN/CLOSE] again.
 - The lock status changes every time [OPEN/CLOSE] is pressed.
 - Repeat step 2 until the desired lock status appears in the panel display.

	Display (Lock type)	Lock status
1	 OFF	Unlocked.
	↓	
2	 TRAY	The disc tray is locked.
	↓	
3	 PANEL	Buttons on the unit are locked*.
	↓	
4	 REMOTE	Buttons on the remote control are locked.
	↓	
5	 RMT+PNL	Buttons on the remote control and the unit are locked*.
	↓	
6	 RMT+TRAY	Buttons on the remote control and the disc tray are locked.
	↓	
1	 OFF	Unlocked.
	↓	

- * Even when buttons on the unit are locked, the [SHIFT] and [OPEN/CLOSE] combination is available.

When Unit Lock is active:

"LOCKED" will be displayed if attempting the locked operation while Unit Lock is active.



📌 Note

- If lock type 2 or 6 is activated while the disc tray is open, it will be activated once the disc tray is closed.
- If the unit is turned off while any lock type is activated, the unit will accept Power On only, and stay locked after the unit is ready.

14 TROUBLESHOOTING

Problem	Tip
No power.	Check if the AC cord is properly connected.
	Unplug the AC cord once, and wait for 5-10 seconds and then plug it in again.
No sound or picture.	Check if the connected TV is turned on.
	Check if the connections are made securely and correctly.
	Check whether the connected TV or other device supports HDCP. (This unit will not output a video signal unless the other device supports HDCP.) However, even on a non-HDCP-compliant TV or other display devices, non-copyrighted contents can be output correctly by setting "HDCP Auto" to "On". (p.45)
	Check whether the output format of this unit (HDMI FORMAT) matches the supported input format of the other connected device.
	Press and hold [II (pause)] on the front panel for 5 seconds to change the setting back to its default.
No reaction to the remote control.	Connect the unit to the power outlet.
	Point the remote control at the unit.
	Insert the batteries with the correct polarity.
	Insert new batteries in the remote control.
	Is "LOCKED" displayed in the panel display? If so, remote control operations are locked. Unlock the remote control. (p.47)
	Is "Power On Play" function enabled? If so, open the disc tray to temporarily disable the function, then set "Power On Play" to "Off". (p.35)
No audio / video signal on the display device via HDMI cable.	If the unit is connected to an unauthorized display device with an HDMI cable, the audio / video signal may not be output.
	Perform an HDMI cable hotplug, wherein you disconnect the HDMI cable from the TV and this unit and then reconnect it to both the devices while they are powered on.
	Ensure that your HDMI cable is certified.
No high-definition video signal on the TV screen.	Does the disc contain high-definition video? High-definition video is not available when the disc does not contain it.
	Does the TV support high-definition video? High-definition video is not available when the TV does not support it.
No audio signal from the loudspeakers of the TV screen.	Assign the audio input of the TV to the corresponding video input.
	Ensure that the TV's speakers are turned on in the TV menu.
No audio signal from the loudspeakers of the audio system.	Turn on the audio system.
	Set the audio system to the correct external audio input.
	Increase the volume level of the audio system.
Distorted picture.	Sometimes a small amount of picture distortion may appear. This is not a malfunction.
Completely distorted picture or black / white picture with Blu-ray Disc™ / DVD.	Make sure the disc is Region compatible or otherwise compatible with this unit.
No sound or distorted sound.	Adjust the volume.
	Check if speakers are connected correctly.
	Check the HDMI connections.
	Check the settings in "Audio Out" menu.
Picture freezes momentarily during playback.	Check the disc for fingerprints / scratches and clean with a soft cloth wiping from center to outer edge.
	Clean the disc.

Problem	Tip
Cannot play back a disc.	Make sure that the product supports the disc.
	Check the region code of the disc. (Refer to page 26.)
	Clean the disc.
USB flash drive cannot be read.	The format of the drive is not accepted by this unit or the drive is not compatible.
Cannot play back JPEG files.	Make sure that the disc was recorded in the UDF, ISO9660 or JOLIET format.
Cannot play back MP3 files.	Make sure that the disc was recorded in the UDF, ISO9660 or JOLIET format.
	Make sure that the bit rate of the MP3 files is between 112 kbps and 320 kbps.
	Make sure that the sample rate of the MP3 files is 32 kHz, 44.1 kHz or 48 kHz.
Cannot play back WMA files.	Make sure that the sample rate of the WMA files is 44.1 kHz or 48 kHz.
Cannot play back WAV files	Make sure that the sample rate of the WAV files is 8kHz, 11.025kHz,12kHz, 16kHz, 22.05kHz, 24kHz, 32kHz,44.1kHz, 48kHz, 64kHz, 88.2kHz, 96kHz, 176.4kHz, or 192kHz on BDs/DVDs/USB flash drives, or 8kHz, 11.025kHz,12kHz, 16kHz, 22.05kHz, 24kHz, 32kHz, 44.1kHz, 48kHz, 64kHz, 88.2kHz, 96kHz on CDs.
No return to the home menu screen when disc is removed.	Reset this unit by turning it off for 30 seconds, then on again.
⊘ in the upper right hand corner of the TV screen.	The operation is not possible.
Buttons do not work or the unit stops responding.	To completely reset the unit, press and hold [STANDBY/ON] on the front panel for 10 seconds to shut down the unit or unplug the AC cord from the AC outlet for 5-10 seconds.
The unit does not respond to some operating commands during playback.	Is "Power On Play" function enabled? If so, open the disc tray to temporarily disable the function, then set "Power On Play" to "Off". (p.35)
	Operations may not be permitted by the disc. Refer to the instructions of the disc.
The unit cannot read Blu-ray Disc™ / DVD/ CD.	Check if the disc is compatible with this unit. (Refer to page 25.)
	Wipe dirt off the disc or replace the disc.
Angle does not switch.	The angle cannot be switched for Blu-ray Disc™ / DVD which do not contain multiple angles. In some cases multiple angles are only recorded for specific scenes.
Playback does not start when the title is selected.	Check setting of "BD Rating Level" or "DVD Rating Level". (Refer to page 45.)
The password for rating level has been forgotten.	Enter the default password "4737", then your forgotten password will be cleared.
Cannot find a JPEG file.	Make sure that the selected group (folder) does not contain more than 9,999 files for Blu-ray Disc™ / DVD / USB flash drive, and 999 files for CD.
	Make sure that the file extension is .jpg, .JPG, .jpeg or .JPEG.
Cannot find an MP3 / WMA / WAV file.	Make sure that the selected folder does not contain more than 9,999 files for Blu-ray Disc™ / DVD / USB flash drive, and 999 files for CD.
	Make sure that the file extension is .mp3 or .MP3 for MP3, and .wma or .WMA for Windows Media™ Audio, and .wav or .WAV for WAV.
Error message appears when I select "Auto" in the "Player Menu".	Make sure that the unit is connected to an HDMI CEC compatible TV and the "HDMI CEC" is set to "On".
	This error message may appear when your TV's OSD language is not supported by this unit.
This unit does not work properly.	Condensation? (Let sit 2 hours)

Problem	Tip
Cannot play back AVCHD file.	This unit cannot play back standalone AVCHD files (*.m2ts, *.mts or *.m2t) written to a DVD or copied to an SD Card. The DVD containing AVCHD files must have a proper file and folder structure meeting AVCHD format specifications. Please use AVCHD compliant device / software to burn or copy AVCHD files to DVD. (Please refer to user manuals of the device / software for more information.)
Cannot connect to the network.	Check if the network connection is properly made.
	Turn on the modem or router.
	Check the network settings.
	Check if the router and/or modem is correctly connected.
	Check the BD-Live™ setting in “Manual” setup on page 41.
When connecting directly to a modem via a LAN cable, you might need to power cycle the modem to reset settings on the modem.	
Cannot connect to the network while my PC is connected to the network.	Check the content of your Internet service contract to see if your Internet Service Provider prevents multiple terminals connecting at the same time.
The capacity of the USB flash drive decreased.	Data may be written to the USB flash drive when a BD-video that supports the virtual package is used and a USB flash drive is connected.
MPEG-2 video and audio on the USB flash drive cannot be played back.	MPEG-2 is noncompliant on this unit.
The contents of the USB flash drive cannot be read.	The USB flash drive is not compatible or the contents on the USB flash drive may be damaged.
	Turn off and then turn the unit on again.
Cannot use the BD-Live™ function or download of data does not perform properly.	Connect a USB flash drive before inserting the disc.
	Connect a USB flash drive with enough capacity (1 GB or more).
	Check if a USB flash drive is correctly connected.
Cannot play back BD-video (BD-ROM Profile 2.0).	Connect a USB flash drive (1 GB or more) which is formatted on this unit. Some discs with BD-Live™ function require memory when playing back the content.
	Do not remove the USB during playback.
The disc tray does not open. The remote control does not work. Buttons on the unit do not work.	Is “LOCKED” displayed in the panel display? If so, the Unit Lock function is enabled. Disable the function. (p.47)

Note

- Do not attempt to repair the Blu-ray Disc™ Player yourself. This may cause severe injury, irreparable damage to your Blu-ray Disc™ Player or void your warranty.
- Please have available your Blu-ray Disc™ Player model and serial number before contacting us. These numbers are available on the cabinet, as well as on the packaging.

15 GLOSSARY

Analog Audio

An electrical signal that directly represents sound. Compare this to digital audio which can be an electrical signal, but is an indirect representation of sound. See also "Digital Audio".

Aspect Ratio

The width of a TV screen relative to its height. Conventional TVs are 4:3 (in other words, the TV screen is almost square); widescreen model are 16:9 (the TV screen is almost twice as wide as its height).

Attenuation

Attenuation is a function to reduce excessive signals to adequate levels. By reducing signal levels, sound quality may improve.

AVCHD

AVCHD is a new format for high definition video camcorders which can record and play high-resolution HD images.

BD-Live™

BD-Live™ is a BD-video (BD-ROM version 2 Profile 2.0) which contains new functions (e.g. Internet connection), in addition to the BONUSVIEW™ function.

Blu-ray Disc™

Blu-ray Disc™ is a next generation optical video disc which is capable of storing much more data than a conventional DVD. The large capacity makes it possible to benefit from the features such as high-definition videos, multi-channel surround sounds, interactive menus and so on.

Chapter

Just as a book is split up into several chapters, a title on a BD-video or DVD-video is usually divided into chapters. See also "Title".

Cinavia™

Cinavia Notice

This product uses Cinavia technology to limit the use of unauthorized copies of some commercially-produced film and videos and their soundtracks. When a prohibited use of an unauthorized copy is detected, a message will be displayed and playback or copying will be interrupted. More information about Cinavia technology is provided at the Cinavia Online Consumer Information Center at <http://www.cinavia.com>

To request additional information about Cinavia by mail, send a postcard with your mailing address to: Cinavia Consumer Information Center, P.O. Box 86851, San Diego, CA, 92138, USA.

This product incorporates proprietary technology under license from Verance Corporation and is protected by U.S. Patent 7,369,677 and other U.S. and worldwide patents issued and pending as well as copyright and trade secret protection for certain aspects of such technology. Cinavia is a trademark of Verance Corporation. Copyright 2004-2016 Verance Corporation. All rights reserved by Verance. Reverse engineering or disassembly is prohibited.

Digital Audio

An indirect representation of sound by numbers. During recording, the sound is measured at discrete intervals (44,100 times a second for CD audio) by an analog-to-digital converter, generating a stream of numbers. On playback, a digital-to-analog converter generates an analog signal based on these numbers. See also "Sampling Frequency" and "Analog Audio".

DNS Server

A server which translates Internet domain names into IP addresses.

Dolby Audio - Dolby® Digital

The system to compress digital sound developed by Dolby Laboratories. It offers you sound of stereo (2ch) or multi-channel audio.

Dolby Audio - Dolby Digital Plus

Dolby Digital Plus is the next generation digital audio compression technology developed as an extension to Dolby Digital. Blu-ray Disc™ supports 7.1 multi-channel surround sound output.

Dolby Audio - Dolby TrueHD

Dolby TrueHD is a lossless coding technology developed for next generation optical discs. Blu-ray Disc™ supports 7.1 multi-channel surround sound output.

DTS® (Digital Theater System)

DTS® is a multi channel surround sound system. You can enjoy movie dynamic and realistic sound like movie theater. DTS surround sound technologies were developed by DTS, Inc.

DTS-HD*

DTS-HD* is a lossless coding technology developed as an extension of the original DTS Coherent Acoustics format. Blu-ray Disc™ supports 7.1 multi-channel surround sound output.

Gateway

IP address of the electronic devices (such as router) which provide Internet access.

HDCP

HDCP stands for High-Bandwidth Digital Content Protection, and is a highly-trusted copyright protection technology whose license is held by Digital Contents Protection, LLC.

Generally, in order to view HDCP content, the display device needs to be HDCP-compliant, as well as the player. This unit, however, has a function called "HDCP Auto" which allows it to work with non-HDCP-compliant display devices for non-copyrighted content playback. (p.45)

HDMI (High-Definition Multimedia Interface)

A digital interface between audio and video source. It can transmit component video, audio, and control signal with one cable connection.

Hub

A device used for connecting multiple device to the network.

IP Address

A set of numbers which are assigned to devices participating in a computer network.

JPEG (Joint Photographic Experts Group)

JPEG is a method of compressing still picture files. You can copy JPEG files on BD-RE/-R, DVD-RW/-R, CD-RW/-R, or USB flash drive, SD Card from a computer and play back the files on this unit.

LAN (Local Area Network)

A group of computer networks covering a small area like a company, school or home.

Local Storage

A storage area of sub contents for playing virtual packages on BD-video.

MP3 (MPEG audio layer 3)

MP3 is a method of compressing files. You can copy MP3 files on BD-RE/-R, DVD-RW/-R, CD-RW/-R, or USB flash drive, SD Card from the computer and play back the files on this unit.

PCM (Pulse Code Modulation)

The most common system of encoding digital audio, found on CD and DAT. Excellent quality, but requires a lot of data compared to formats such as Dolby Digital and MPEG audio. For compatibility with digital audio recorders (CD, MD and DAT) and AV amplifiers with digital inputs, this unit can convert Dolby Digital, DTS, and MPEG audio to PCM. See also "Digital Audio".

Proxy Server

Proxy server is a server which acts as an intermediary between a workstation user and the Internet to ensure security.

Region Code

Regions associate discs and players with particular areas of the world. This unit will only play back discs that have compatible region codes. You can find the region code of your unit by looking on the rear panel. Some discs are compatible with more than one region (or all regions).

Router

A networking device which distinguishes the IP address assigned to each device and routing and forwarding information in the computer network.

Sampling Frequency

The rate which sound is measured by a specified interval to turn into digital audio data. The numbers of sampling in one second defines as sampling frequency. The higher the rate, the better the sound quality.

Subnet Mask

A mask which is used to determine what subnet an IP address belongs to.

Title

A collection of chapters on BD-video or DVD-video. See also "Chapter".

Track

Audio CD uses tracks to divide up the content of a disc. The BD-video or DVD-video equivalent is called a chapter. See also "Chapter".

Virtual Package

The function which copies data to other media (local storage) from the Internet and plays secondary video, secondary audio and subtitles at the same time. The method of the playback varies depending on discs.

WAV

WAV is the audio compressing technology developed by Microsoft and IBM. You can copy WAV files on BD-RE/-R, DVD-RW/-R, CD-RW/-R, or USB flash drive, SD Card from a computer and play them back on this unit.

Windows Media™ Audio

Windows Media™ Audio is the audio compressing technology developed by Microsoft. You can copy Windows Media™ Audio files on BD-RE/-R, DVD-RW/-R, CD-RW/-R, or USB flash drive, SD Card from a computer and play them back on this unit.

x.v.Color

"x.v.Color" is a promotion name given to the products that have the capability to realize a wide color space based on the xvYCC specifications and is a trademark of Sony Corporation.

16 LANGUAGE CODE LIST

Language	Code	Language	Code	Language	Code	Language	Code
A-B		French [FRE]	5264	Macedonian	5957	Siswat	6565
Abkhazian	4748	Frisian	5271	Malagasy	5953	Slovak [SLO]	6557
Afar	4747	Galician	5358	Malay	5965	Slovenian	6558
Afrikaans	4752	Georgian	5747	Malayalam	5958	Somali	6561
Albanian	6563	German [GER]	5051	Maltese	5966	Spanish [SPA]	5165
Amharic	4759	Greek [GRE]	5158	Maori	5955	Sundanese	6567
Arabic	4764	Greenlandic	5758	Marathi	5964	Swahili	6569
Armenian	5471	Guarani	5360	Moldavian	5961	Swedish [SWE]	6568
Assamese	4765	Gujarati	5367	Mongolian	5960	T	
Aymara	4771	Hausa	5447	Nauru	6047	Tagalog	6658
Azerbaijani	4772	Hebrew	5451	Nepali	6051	Tajik	6653
Bashkir	4847	Hindi	5455	Norwegian [NOR]	6061	Tamil	6647
Basque	5167	Hungarian [HUN]	5467	O-R		Tatar	6666
Bengali;Bangla	4860	I-K		Occitan	6149	Telugu	6651
Bhutani	5072	Icelandic [ICE]	5565	Oriya	6164	Thai	6654
Bihari	4854	Indonesian	5550	Oromo (Afan)	6159	Tibetan	4861
Bislama	4855	Interlingua	5547	Panjabi	6247	Tigrinya	6655
Breton	4864	Interlingue	5551	Pashto;Pushto	6265	Tonga	6661
Bulgarian [BUL]	4853	Inupiak	5557	Persian	5247	Tsonga	6665
Burmese	5971	Irish [GLE]	5347	Polish [POL]	6258	Turkish [TUR]	6664
Byelorussian	4851	Italian [ITA]	5566	Portuguese [POR]	6266	Turkmen	6657
C-E		Japanese [JPN]	5647	Quechua	6367	Twi	6669
Cambodian	5759	Javanese	5668	Rhaeto-Romance	6459	U-Z	
Catalan	4947	Kannada	5760	Romanian [RUM]	6461	Ukrainian	6757
Chinese [CHI]	7254	Kashmiri	5765	Russian [RUS]	6467	Urdu	6764
Corsican	4961	Kazakh	5757	S		Uzbek	6772
Croatian	5464	Kinyarwanda	6469	Samoan	6559	Vietnamese	6855
Czech [CZE]	4965	Kirghiz	5771	Sangho	6553	Volapuk	6861
Danish [DAN]	5047	Kirundi	6460	Sanskrit	6547	Welsh	4971
Dutch [DUT]	6058	Korean [KOR]	5761	Scots Gaelic	5350	Wolof	6961
English [ENG]	5160	Kurdish	5767	Serbian	6564	Xhosa	7054
Esperanto	5161	L-N		Serbo-Croatian	6554	Yiddish	7155
Estonian	5166	Laothian	5861	Sesotho	6566	Yoruba	7161
F-H		Latin	5847	Setswana	6660	Zulu	7267
Faroese	5261	Latvian;Lettish	5868	Shona	6560		
Fiji	5256	Lingala	5860	Sindhi	6550		
Finnish [FIN]	5255	Lithuanian	5866	Singhalese	6555		

Note

- If you choose a language that has a 3-letter-language code (written in bracket), the code will be displayed every time you change the subtitle language setting on page 36 or audio language setting on page 36. If you choose any other languages, “---” will be displayed instead.

17 SPECIFICATIONS

General	BD-01U
Signal system	NTSC Color (for USA/Canada model), NTSC/PAL Color (for Europe model)
Power requirements	AC 120 V,60 Hz (for USA/CANADA model), AC 230 V, 50 Hz (for Europe model)
Power consumption	16.5 W
Dimensions (width x height x depth)	19-1/16 x 1-13/16 x 10-3/16 inches (483 x 45 x 257.8 mm)
Weight	4.98 lbs (2.26 kg)
Operating temperature	41 °F (5 °C) to 95 °F (35 °C)
Operating humidity	Less than 80 % (no condensation)

Audio	
BD Linear Audio	4 Hz–88 kHz (192 kHz)
DVD Linear Audio	4 Hz–44 kHz (96 kHz), 4 Hz–22 kHz (48 kHz)
Audio CD	20 Hz–20 kHz (44.1 kHz)
Frequency Response	20 Hz - 20 kHz, +/-1.0 dB (during playback, JEITA)
Signal to Noise Ratio	90 dB (during playback, JEITA)
Audio Dynamic Range	90 dB (during playback, JEITA)
THD (Total Harmonic Distortion)	0.01 % (1 kHz) (during playback, JEITA)
Channel Separation	90 dB (during playback, JEITA)

Terminals	
USB input	USB 2.0
TYPE A	Bus power current: MAX. 500 mA
ANALOG OUTPUTS (UNBALANCED)	Reference Output Level: -10 dBV (0.316 Vrms)
RCA jack	Maximum Output Level: +6 dBV (2.0 Vrms) Output impedance: 200 Ω
ANALOG OUTPUTS (BALANCED)	Reference Output Level: +4 dBu (1.23 Vrms)
XLR-3-32(1: GND, 2: HOT, 3: COLD)	Maximum Output Level: +20 dBu (7.75 Vrms) Output impedance: 100 Ω
DIGITAL OUTPUTS	
RCA jack	Compatible Signal Format: IEC-60958-3 (S/PDIF) Output impedance: 75 Ω
Optical jack	Compatible Signal Format: IEC-60958-3 (S/PDIF)
HDMI OUTPUT	19-pin, Type A
HDMI jack	Video: 480p/576p*, 720p, 1080i, 1080p, 1080p24 / Audio
ETHERNET terminal	10BASE-T/100BASE-TX
RS-232C	D-sub 9-pin

* 576p: For Europe model.

Dimensions

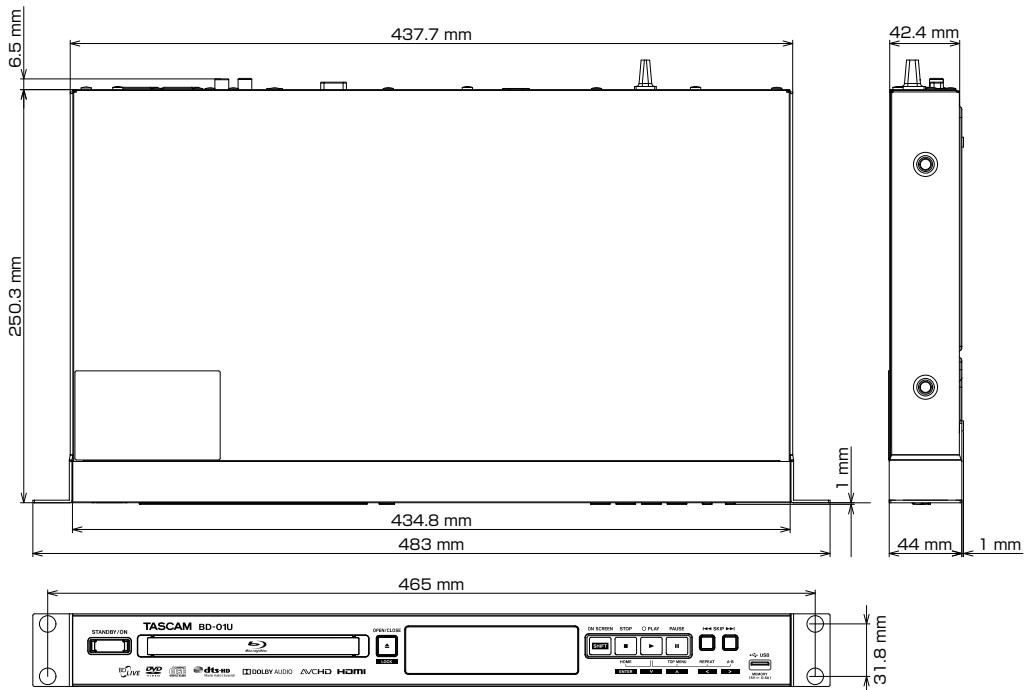

Note

- Illustrations in this Owner's Manual might differ in part from the actual product. Specifications and external appearance could be changed without notification to improve the product.

WARRANTY

< In the United States >

This warranty gives you specific legal rights and you may also have other rights which vary from state to state. This warranty is only valid within the country the unit was originally purchased.

WHAT IS AND IS NOT COVERED

Except as specified below, this warranty covers all defects in materials and workmanship in this product. The following are not covered by the warranty:

1. **Damage to or deterioration of the external cabinet.**
2. **Damages resulting from accident, misuse, abuse or neglect.**
3. **Damage resulting from failure to perform basic daily maintenance and/or calibration or otherwise resulting from failure to follow instructions contained in your owner's manual.**
4. **Damage occurring during shipment of the product. (Claims must be presented to the carrier)**
5. **Damage resulting from repair or attempted repair by anyone other than TEAC or an authorized TASCAM service station.**
6. **Damage resulting from causes other than product defects, including lack of technical skill, competence, or experience of the user.**
7. **Damage to any unit which has been altered or on which the serial number has been defaced, modified or is missing.**

WHO MAY ENFORCE THE WARRANTY

This warranty may be enforced only by the original purchaser. This warranty is not valid if the product was purchased through an unauthorized dealer.

LENGTH OF WARRANTY

All parts except heads and disk drives are warranted for one (1) year from the date of original purchase. Heads and disk drives are warranted to ninety (90) days from date of original purchase. Labor is warranted for ninety (90) days from date of original purchase.

WHAT WE WILL PAY FOR

We will pay all labor and material expenses for items covered by the warranty. Payment of shipping charges is discussed in the next section of this warranty.

HOW YOU CAN GET WARRANTY SERVICE

Your unit must be serviced by an authorized TASCAM service station in the United States. (This warranty is not enforceable outside the U.S.) If you are unable to locate an authorized TASCAM service station in your area, please contact us. We either will refer you to an authorized service station or instruct you to return the unit to the factory. Whenever warranty service is required, you must present a copy of the original dated sales receipt from an Authorized TASCAM Dealer.

You must pay any shipping charges if it is necessary to ship the product to service. However, if the necessary repairs are covered by the warranty, we will pay return surface shipping charges to any destination within the United States.

LIMITATION OF IMPLIED WARRANTIES

Any implied warranties, INCLUDING WARRANTIES OF MERCHANTABILITY AND FITNESS FOR A PARTICULAR PURPOSE, are limited in duration to the length of this warranty.

EXCLUSION OF DAMAGES

TEAC's liability for any defective product is limited to repair or replacement of the product, at TEAC's option. TEAC shall not be liable for:

1. **Damages based upon inconvenience, loss of use of the product, loss of time interrupted operation or commercial loss; or**
2. **Any other damages, whether incidental, consequential or otherwise.**

Some states do not allow limitations on how long an implied warranty lasts and/or do not allow the exclusion or limitation of incidental or consequential damages, so the above limitations and exclusions may not apply to you.

To locate an Authorized Service Center in Your Area

CALL 1-800-447-8322

< Europe >

This product is subject to the legal warranty regulations of the country of purchase. In case of a defect or a problem, please contact the dealer where you bought the product.

Ce produit est sujet aux réglementations concernant la garantie légale dans le pays d'achat. En cas de défaut ou de problème, veuillez contacter le revendeur chez qui vous avez acheté le produit.

Dieses Gerät unterliegt den gesetzlichen Gewährleistungsbestimmungen des Landes, in dem es erworben wurde. Bitte wenden Sie sich im Gewährleistungsfall an den Händler, bei dem sie das Gerät erworben haben.

Questo apparecchio è conforme alle norme sulla garanzia vigenti nel rispettivo Paese in cui esso è stato acquistato. Si prega di rivolgersi al proprio commerciante, presso il quale è stato acquistato l'apparecchio, nel caso in cui si voglia richiedere una prestazione in garanzia.

Las condiciones de garantía de este aparato están sujetas a las disposiciones legales sobre garantía del país en el que ha sido adquirido. En caso de garantía, debe dirigirse al establecimiento donde adquirió el aparato.

< In other countries/areas >

This warranty gives you specific legal rights, and you may also have other rights that vary by country, state or province.

If you have a warranty claim or request, please contact the dealer where you bought the product.

该保证书赋予了顾客特定的合法权利，并且因国家、州或省等地域的不同，顾客可能拥有其他权利。如需申请或要求保修，请与购买本产品的销售店进行联系。

If you require repair services for your TASCAM equipment, please contact the dealer where the product was purchased from or the TASCAM Distributor in your country. A list of TASCAM Distributors can be found on our website at: <http://teac-global.com/>

TASCAM

TEAC CORPORATION

Phone: +81-42-356-9143
1-47 Ochiai, Tama-shi, Tokyo 206-8530 Japan

<http://tascam.jp/>

TEAC AMERICA, INC.

Phone: +1-323-726-0303
1834 Gage Road, Montebello, California 90640 USA

<http://tascam.com/>

TEAC MEXICO, S.A. de C.V.

Phone: +52-55-5010-6000
Río Churubusco 364, Colonia Del Carmen, Delegación Coyoacán, CP 04100, México DF, México

<http://teacmexico.net/>

TEAC UK Ltd.

Phone: +44-8451-302511
2 Huxley Road, Surrey Research Park, Guildford, GU2 7RE, United Kingdom

<http://tascam.eu/>

TEAC EUROPE GmbH

Phone: +49-611-71580
Bahnstrasse 12, 65205 Wiesbaden-Erbenheim, Germany

<http://tascam.eu/>

TEAC SALES & TRADING(SHENZHEN) CO., LTD

Phone: +86-755-88311561~2
Room 817, Block A, Hailrun Complex, 6021 Shennan Blvd., Futian District, Shenzhen 518040, China

<http://tascam.cn/>

ECP00EH
BD-01U EUR-Y(G)
Printed in China 2VMN00254 ★★★★★



WARRANTY

Model/Modèle/Modell
Modello/Modelo/型号

BD-01U

Owner's name/Nom du possesseur/Name des Eigentümers
Nome del proprietario/Nombre del propietario/顾客姓名

Serial No./No de Série/Seriennummer
Número de serie/número de serie/序列号

Address/Adresse/Adresse
Indirizzo/Dirección/顾客地址

Date of purchase/Date deachat/Datein kauf
Data de aquisição/fecha de compra/购买日期

Dealer's name/Nom du détaillant/Name des Händlers
Nombre del comerciante/Nombre del establecimiento/销售店名

TASCAM
<http://teac-global.com/>

Dealer's address/Adresse du détaillant/Adresse des Händlers
Indirizzo del commerciante/Dirección del establecimiento/销售店地址

Sample