

WALL MOUNT SPEAKER

BS-678

Thank you for purchasing TOA's Wall Mount Speaker.
Please carefully follow the instructions in this manual to ensure long, trouble-free use of your equipment.

⚠ CAUTION

Indicates a potentially hazardous situation which, if mishandled, could result in moderate or minor personal injury, and/or property damage.

- To avoid electric shocks, be sure to switch off the amplifier's power when connecting speakers.
- Do not operate the unit for an extended period of time with the sound distorting. This is an indication of a malfunction, which in turn can cause heat to generate and result in a fire.
- Do not stand or sit on, nor hang down from the unit as this may cause it to fall down or drop, resulting in personal injury and/or property damage.

1. SAFETY PRECAUTIONS

- Before installation or use, be sure to carefully read all the instructions in this section for correct and safe operation.
- Be sure to follow all the precautionary instructions in this section, which contain important warnings and/or cautions regarding safety.
- After reading, keep this manual handy for future reference.

⚠ WARNING

Indicates a potentially hazardous situation which, if mishandled, could result in death or serious personal injury.

- Install the unit only in a location that can structurally support the weight of the unit and the mounting bracket. Doing otherwise may result in the unit falling down and causing personal injury and/or property damage.
- Do not use other methods than specified to mount the bracket. Extreme force is applied to the unit and the unit could fall off, possibly resulting in personal injuries.
- Tighten each nut and bolt securely. Ensure that the bracket has no loose joints after installation to prevent accidents that could result in personal injury.

2. FEATURES

- The BS-678, of which cabinet is made of wood, can be installed in a vertical or horizontal orientation.
- Either concealed in-wall wiring or exposed wiring can be used for speaker cable connection.
- The speaker structure that permits direct wall-mounting with screws prevents the speaker from falling easily even if an outward force is applied to.
- The input impedance can be easily changed by changing the tap position of the transformer.
- Two built-in 6-inch double cone speaker units deliver high quality sound.
- The push-in type input connector makes cable connections easy and allows bridge wiring.

3. WIRING DIAGRAM

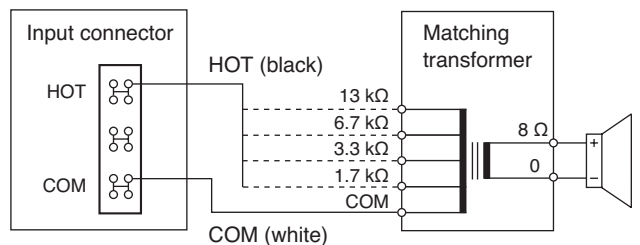

4. SPECIFICATIONS

Rated Input	6 W (100 V LINE), 3 W (70 V LINE)
Rated Impedance	100 V line: 1.7 kΩ (6 W), 3.3 kΩ (3 W), 6.7 kΩ (1.5 W), 13 kΩ (0.8 W) 70 V line: 1.7 kΩ (3 W), 3.3 kΩ (1.5 W), 6.7 kΩ (0.8 W), 13 kΩ (0.4 W)
Sensitivity	94 dB at 1 W, 1 m (500 – 5,000 Hz, pink noise)
Frequency Response	150 – 20,000 Hz (at 20 dB below peak)
Speaker Component	16 cm (6") double cone type
Application Cable	600 V vinyl-insulated cable (IV wire or HIV wire) Solid wire: ϕ 0.8 – ϕ 1.6 mm (equivalent to AWG 20 – 14) 7-core twisted wire: 0.75 – 1.25 mm ² (equivalent to AWG 18 – 16)
Connection	Push-in connector (bridging terminal)
Finish	Baffle: HIPS, off white (RAL 9010 or equivalent color) Cabinet: Particle Board with pvc sheet, off white (RAL 9010 or equivalent color) Grille: Surface-treated steel plate net, off white (RAL 9010 or equivalent color)
Dimensions	250 (w) x 190 (h) x 110 (d) mm (9.84" x 7.48" x 4.33")
Weight	1.5 kg (3.31 lb)
Accessories	Tapping screw (4 x 35) 2

Note: The design and specifications are subject to change without notice for improvement.

5. INSTALLATION

Note: When mounting the BS-678 to plaster board walls be sure to use sufficient "anchoring type" bolts from the local hardware store instead of the supplied screws.

Step 1. Pull out the baffle, unlatch 2 V-shaped springs, then remove the baffle from the cabinet.

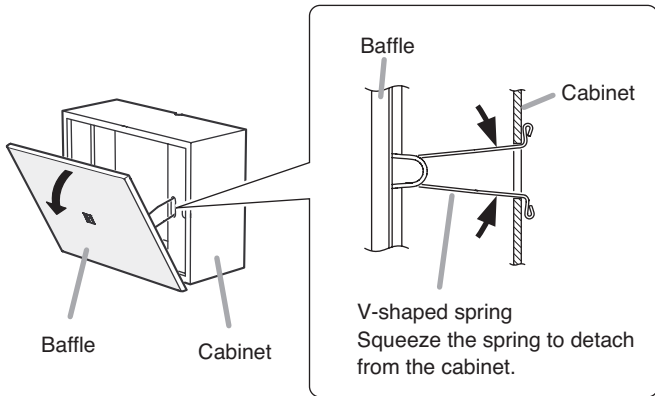

Step 2. Install the cabinet to the wall using the supplied tapping screws 4 x 35. In this case, route the cables from a cable entry hole.

Note

The speaker can be installed in a vertical or horizontal orientation. Either concealed in-wall wiring or exposed wiring are available for speaker cable connection.

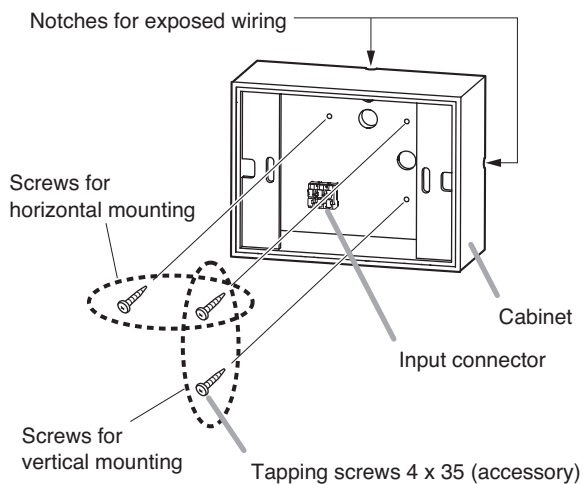

[Cabinet mounting dimensions]

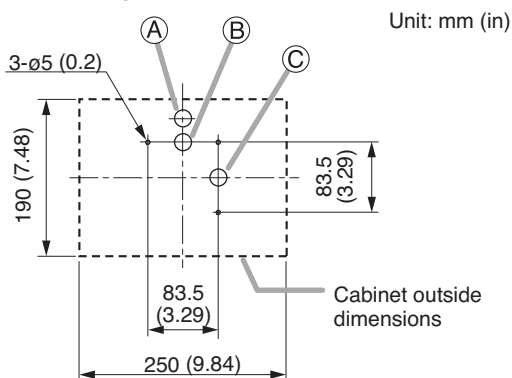

- Ⓐ Cable entry hole (for exposed wiring at horizontal mounting)
- Ⓑ Cable entry hole (for concealed wiring at horizontal mounting)
- Ⓒ Cable entry hole (for concealed and exposed wirings at vertical mounting)

Step 3. Make wiring.

3-1. Insert the lead-in cables (cables from the amplifier) and lead-out cables (cables to other speakers) into the push-in connector attached to the cabinet.

[Applicable cable]

Solid wire: $\varnothing 0.8$ to $\varnothing 1.6$ mm (equivalent to AWG 20 – 14)
Stranded wire (7-core): 0.75 to 1.25 mm² (equivalent to AWG 18 – 16)

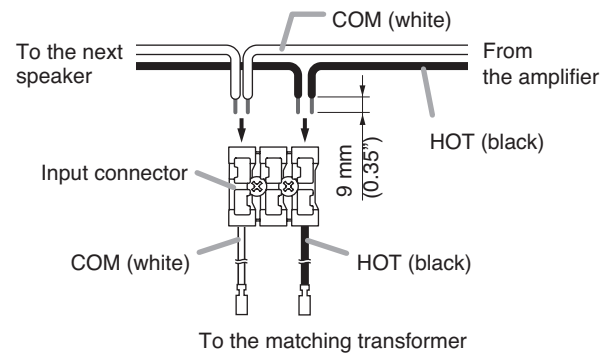

3-2. Insert the fasten terminals fitted at the ends of both the HOT (black) and COM (white) cables from the input connector on the cabinet into the taps of the matching transformer on the speaker unit.

Connect the COM (white) cable to the transformer's COM tap, and the HOT (black) cable to the desired transformer's input tap. (Refer to the figure below.)

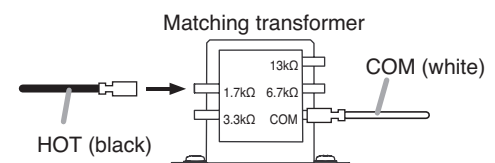
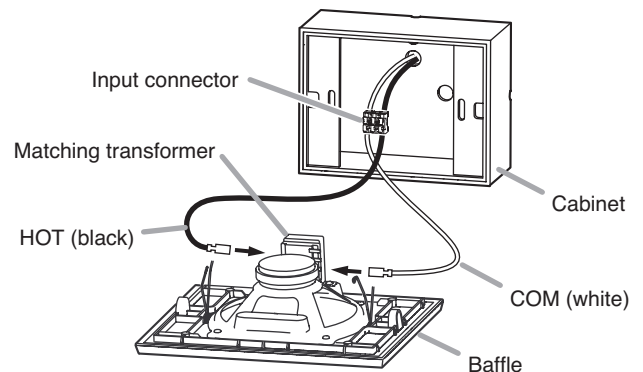

Impedance	1.7 kΩ	3.3 kΩ	6.7 kΩ	13 kΩ
100 V line	6 W	3 W	1.5 W	0.8 W
70 V line	3 W	1.5 W	0.8 W	0.4 W

Step 4. Hook 2 V-shaped springs attached to the baffle into the slotted holes of the cabinet, then push the baffle onto the cabinet.

Note

When the speaker mounting orientation is vertical, pinch and rotate the logo mark on the baffle into the right position.

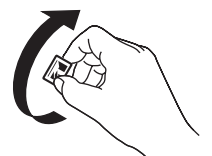

TEI Rev1

URL: <http://www.toa.jp/>