



# CC Series Amplifiers

## Model CC4052, CC4052m, & CC4062MBT

### Installation and Use Manual

**NOTICE:** Every effort was made to ensure that the information in this guide was complete and accurate at the time of printing. However, information is subject to change.

**WARNING:** To reduce the risk of Fire or Electric Shock, Do Not Expose this apparatus to rain or moisture.

Apparatus shall not be exposed to dripping or splashing and no objects filled with liquids, such as vases shall be placed on the apparatus.

**WARNING:** Only connect unit to AC mains outlet providing protective earthing connection.

**NOTE:** Mains plug is used as disconnect device from the mains and shall remain readily accessible and operable.



**CAUTION:** These servicing instructions are for use by qualified service personnel only. To reduce the risk of electric shock, do not perform any servicing other than that contained in the operating instructions unless you are qualified to do so.

**CAUTION: DO NOT INSTALL OR PLACE THIS UNIT IN A BOOKCASE, BUILT-IN CABINET, OR IN ANOTHER CONFINED SPACE. ENSURE THE UNIT IS WELL VENTILATED. TO PREVENT THE RISK OF SHOCK OR FIRE HAZARD DUE TO OVERHEATING, ENSURE THAT CURTAINS AND ANY OTHER MATERIALS DO NOT OBSTRUCT THE VENTILATION VENTS.**

Always follow these basic safety precautions when installing and using the unit:

### **IMPORTANT SAFETY INSTRUCTIONS**

1. Read these instructions.
2. Keep these instructions.
3. Heed all warnings.
4. Follow all instructions.
5. Do not use this apparatus near water.
6. Clean unit with dry cloth.
7. Do not block any ventilation openings. Install in accordance with the manufacturer's instructions.
8. Do not install near any heat sources such as radiators, heat registers, stoves, or other apparatus (including amplifiers) that produce heat.
9. Do not defeat the safety purpose of the polarized or grounding-type plug. A polarized plug has two blades with one wider than the other. A grounding-type plug has two blades and a third grounding prong. The wide blade, or the third prong, are provided for your safety. If the provided plug does not fit into your outlet, consult an electrician for replacement of the obsolete outlet.
10. Protect the power cord from being walked on or pinched particularly at plugs, convenience receptacles, and the point where they exit from the apparatus.
11. Only use attachments/accessories specified by the manufacturer.
12. Unplug this apparatus during lightning storms or when not used for long periods of time.
13. Refer all servicing to qualified service personnel. Servicing is required when the apparatus has been damaged in any way, such as power-supply cord or plug is damaged, liquid has been spilled or objects have fallen into the apparatus, the apparatus has been exposed to rain or moisture, does not operate normally, or has been dropped.

<p><b>CAUTION</b> <b>RISK OF ELECTRIC SHOCK</b> <b>DO NOT OPEN</b></p>	<p><b>CAUTION: TO PREVENT THE RISK OF ELECTRIC SHOCK, DO NOT REMOVE ANY FRONT/BACK COVERS OR PANELS. NO USER-SERVICEABLE PARTS INSIDE. REFER SERVICING TO QUALIFIED PERSONNEL.</b></p>
	<p>The lightning flash with arrowhead symbol, within an equilateral triangle, is intended to alert the user to the presence of uninsulated "dangerous voltage" within the product's enclosure that may be of sufficient magnitude to constitute a risk of electric shock to persons.</p>
	<p>The exclamation point within an equilateral triangle is intended to alert the user to the presence of important operating and maintenance (servicing) instructions.</p>

# Contents

---

<b>Important Safety Information</b> .....	<b>2</b>
<b>Panel Descriptions</b> .....	<b>4-5</b>
Front Panel .....	4
Rear Panel .....	5
<b>Output Connections</b> .....	<b>6</b>
Speaker Outputs	
MOH Output	
REC Output	
<b>Input Connections</b> .....	<b>7</b>
Balanced- TEL Input	
Balanced- LINE/MIC Inputs (1-3)	
Unbalanced- LINE Inputs (1-3)	
AUX Input 4	
24V DC IN	
<b>Operation</b> .....	<b>8-10</b>
Level Controls	
Bass and Treble Controls	
TEL Input Level Control	
LINE/MIC Selector Switch	
Mute Send	
MOH Output Level Control	
MOH Source Select	
Media Player	
Bluetooth	
<b>Cooling</b> .....	<b>11</b>
<b>Accessories: Rack Mount Adapter</b> .....	<b>11</b>
<b>Technical Specifications</b> .....	<b>11</b>
<b>Limited Warranty; Exclusion of Certain Damages</b> .....	<b>12</b>

# Panel Descriptions

## Front Panel

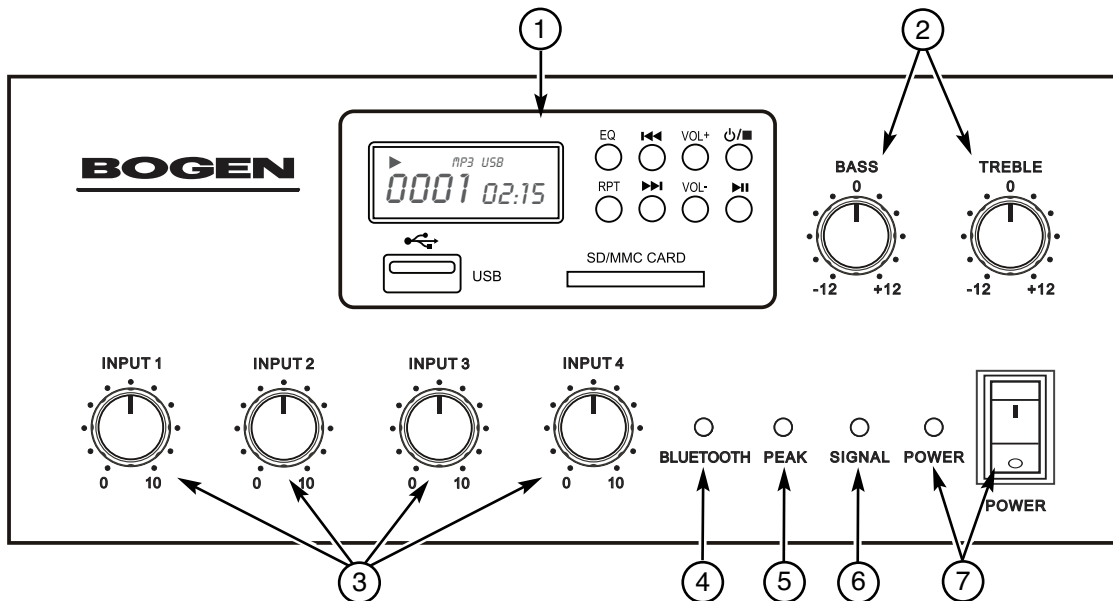

- 1. Media Player (Models CC4052m & CC4062MBT Only)**  
Play MP3 files from either an SD card or a USB memory stick. Media player program material can be used as the MOH source.
- 2. Bass & Treble**  
Separate controls for bass and treble allow adjustment of tonal quality.
- 3. Input Level Controls**  
A front-mounted level control is provided for each rear input.
- 4. Bluetooth Indicator (for Model CC4062MBT Only)**  
This indicator blinks when searching for a signal, and illuminates steadily when connected to a Bluetooth transmitting device. This input is always muted by Input 1 when muting is enabled.
- 5. Peak Indicator**  
This indicator illuminates when the amplifier reaches peak output level.
- 6. Signal Indicator**  
This indicator illuminates when a signal is present at any input.
- 7. Power Switch & Indicator**  
The amplifier power is switched on or off using this switch. The indicator illuminates when the amplifier is powered on.

# Panel Descriptions

## Rear Panel

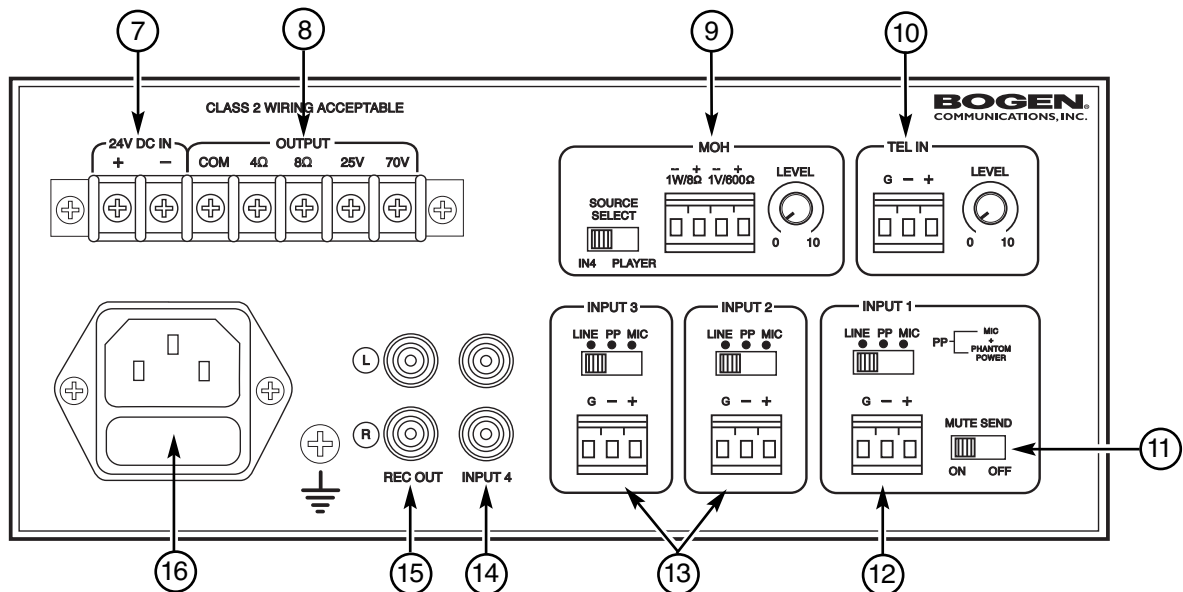

### 7. External DC Supply Input

Connections for an external 24V DC supply to power the amplifier.

### 8. Speaker Outputs

Output terminals for connection to either 70V, 25V, or low-impedance speaker types.

### 9. Music-On-Hold Function (MOH) (for Models CC4052m & CC4062MBT Only)

Two MOH output types are available - a 1W/8-ohm output and a 600-ohm transformer-isolated output. The level control adjusts the MOH output volume. The slide switch selects MOH output program material from either the Media Player or Input 4, neither of which is muted on this MOH Output.

### 10. TEL Input

This is a dedicated transformer-isolated TEL input with input level control. This input will mute all other inputs when active.

### 11. Mute Send

The ability of Input 1 to mute Inputs 2, 3, 4, Media Player, and Bluetooth can be enabled or disabled using this switch.

### 12. Input 1- Balanced LINE/MIC

Input 1 will provide an electronically-balanced input with selectable gain suitable for line-level signals, including dry loop telephone signals as well as balanced low-impedance microphones. The associated slide switch sets the input for LINE, MIC or PP (MIC with phantom power). This input can be set to mute Inputs 2, 3, 4, Media Player, and Bluetooth when active. This input is always muted by the TEL Input.

### 13. Inputs 2 & 3 - Balanced LINE/MIC

Inputs 2 and 3 will provide an electronically-balanced input with selectable gain suitable for line-level signals, including dry loop telephone signals as well as balanced low-impedance microphones. The associated slide switch sets the input for LINE, MIC or PP (MIC with phantom power). These inputs are muted by Input 1 when muting is enabled. These inputs are always muted by the TEL Input.

### 14. Input 4 - Unbalanced AUX

Provides a high-impedance input through a set of stereo combining RCA jacks. This input is always muted by Input 1 when muting is enabled. Input 4 can also be selected as the source for the MOH Output

### 15. REC Output

These RCA connectors provide a signal-level output of the program material provided to the speaker.

### 16. AC Mains

AC mains voltage will be provided through an IEC connector with fuse holder and detachable 3-conductor IEC cord. The nominal line voltage is 120V AC, 60 Hz.

# Output Connections

## Speaker Outputs

The amplifier's speaker output terminal strip provides connections for 70V and 25V speaker systems, as well as low-impedance speakers loads of 4- or 8-ohm impedance. Connect one end of the speaker load to the COM terminal and the other side of the load to the terminal corresponding to the type of system being driven (transformer-coupled 70/25V speaker or low-impedance speakers without transformers).

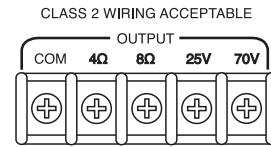

## MOH Output (for Models CC4052m & CC4062MBT Only)

Two types of MOH outputs can be selected - a 1-watt, 8-ohm unbalanced output and a 600-ohm transformer-isolated, balanced output. Most current telephone systems will be compatible with the 600-ohm output. Some older switches require a higher power signal source to drive the telephone load. For these systems, use the 1W/8-ohm output.

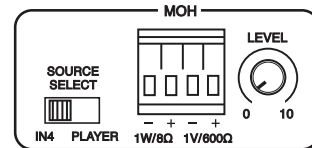

NOTE: MOH Output is never muted.

## REC Output

This set of RCA connectors provide a signal-level output of the program material provided to the speaker. Both outputs supply the same mono signal (not stereo). This signal is suitable to drive recording devices or another amplifier. This output is after the Bass and Treble controls.



REC OUT

# Input Connections

## Balanced - TEL Input

The TEL input is a transformer-balanced input. The telephone signal should be Dry Audio with no DC voltage between the signal lines. If the telephone has a DC voltage across it, a telephone interface adapter should be used to provide a compatible signal for this input. Wire one of the signal lines “+” terminal and the other to the “-” terminal. Generally there is no shield for the telephone signal, but if the cable has one, connect it to the G terminal. The “+” & “-” designations for this input refer to the phase of the signal, so even if the “+” & “-” connections were reversed the amp would still work fine. TEL Input will mute all other inputs when active.

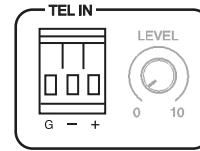

## Balanced - LINE/MIC Inputs (1 to 3)

Inputs 1 through 3 are compatible with balanced telephone/line-level signals and microphone-level signals. Wiring for balanced MIC and balanced line signals are the same with the positive signal line going to “+”, the negative going to “-” and the cable’s shield going to G. The + and - designations refer only to the phase of the signal, so even if the + and - connections were reversed, the amp would still work fine. See the Operation section for details on setting the associated switches. Input 1 has the ability to mute Inputs 2, 3, Media Player, and Bluetooth when active depending on the setting of the Mute Send switch. These inputs are always muted by TEL Input when active.

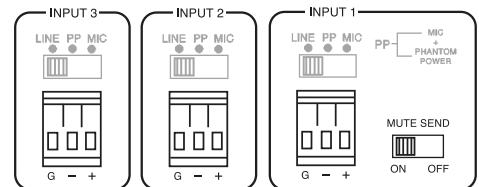

## Unbalanced - LINE Inputs (1 to 3)

Inputs 1 through 3 can be wired to accept mono unbalanced signal sources. Convert a balanced input to unbalanced by wiring a shorting jumper from the G terminal to the “-”. The unbalanced signal’s hot lead is then wired to the “+” terminal and the shield is connected to the G terminal.

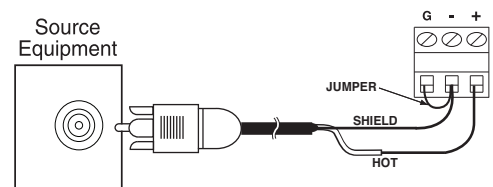

## AUX Input 4

Input 4 is a stereo-combining input, compatible with unbalanced line-level (AUX) signals. This input may be muted by audio activity at Input 1 depending on the setting of the Mute Send switch. This input is always muted by TEL Input when active. This input is never muted on the MOH Output.



## 24V DC IN

The amplifier can be powered by an external power source that can supply 24V DC and 3 amps of current. Wire the power source to the terminals observing the polarities marked on the terminals.

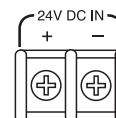

# Operation

## Level Controls

The amplifier provides separate input level controls on the unit front panel for rear inputs 1 through 4. Turn knobs clockwise to increase, or counterclockwise to decrease levels.

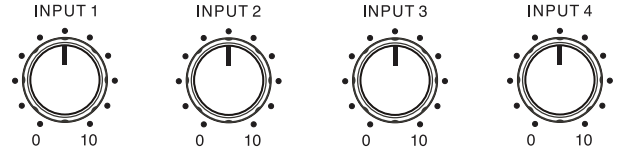

## Bass & Treble Controls

Bass and treble controls are located on the front of the unit to provide tailoring of the unit's frequency response.

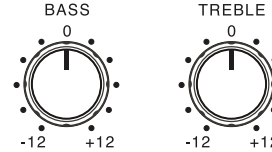

## TEL Input Level Control

The volume level of the TEL Input is located on the rear panel of the amplifier. Turn knob clockwise to increase, or counterclockwise to decrease levels.

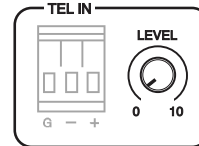

## LINE/MIC Selector Switch

Inputs 1 through 3 provide an electronically-balanced input with selectable gain suitable for microphone and LINE/TEL level signals.

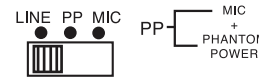

- For balanced, low-impedance microphones, the switch should be set to the MIC position.
- For balanced, condenser microphones, the switch should be set to PP which will provide phantom power to the microphone.
- For balanced line-level or telephone-level signals, the switch should be set to LINE. If using the input with an unbalanced line-level signal, the switch should also be set to LINE (see the section on input connections for instructions on unbalanced input wiring).

## Mute Send

The mute send switch is used to disable Input 1 from muting Inputs 2, 3, 4, Media Player, and Bluetooth. Set this switch to ON if voice-activated muting of Inputs 2, 3, 4, Media Player, and Bluetooth by Input 1 is desired. With this switch set to OFF, the amplifier will act as a  $n \times 1$  mixer with no priority override. NOTE: TEL input will always mute all other inputs and is not defeatable.

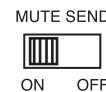

## MOH Output Level Control (for Models CC4052m & CC4062MBT)

The rear panel mounted MOH control adjusts the MOH output level. Turn knob clockwise to increase, or counterclockwise to decrease levels.

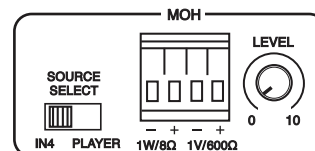

## MOH Source Select (for Models CC4052m & CC4062MBT)

The rear-mounted source select switch allows either the Media Player or Input 4 to be set as the source for the MOH output. Only the selected source will play out of the MOH output regardless of what paging/priority activity is happening in the amplifier.

# Operation

## Media Player (for Models CC4052m & CC4062MBT)

The Media Player can play MP3 or WMA files from either an SD card or a USB memory stick inserted into the player on the front panel of the amplifier. Pushbuttons on the front of the media player control operation functions and an LCD screen displays status information (see below). Media player program material is muted by both the TEL Input and Input 1 (when Mute Send is on). Media Player program is never muted on the MOH Output.

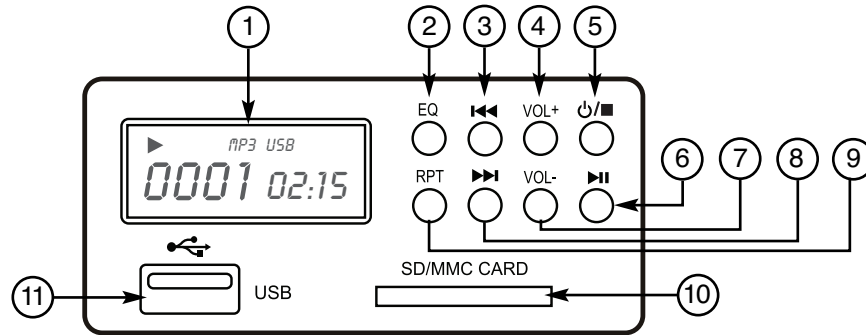

**1. LCD Display Screen** (see below)

**2. Equalizer Button**

Preset Equalization for the four preset music types: POP, CLASSIC, JAZZ, ROCK. A selection of "none" of the presets is also available.

**3. Previous Music/Track Selection Button**

Begins playing from start of previous track.

**4. Volume Up (+) Button**

Increases volume for both MOH and MP3 Player.

**5. ON/OFF Power Button**

**6. Play/Pause Button**

**7. Volume Down (-) Button**



Decreases volume for both MOH and MP3 Player.

**8. Next Music/Track Selection Button**

Begins playing the next track.

**9. Repeat Button**

3 toggle settings available:

-  Repeats current selection
-  Repeats entire memory card

RANDOM Randomized Playback\*

**10. SD/MMC Card Insert Dock**

Player accepts card with up to 16 GB of memory\*\*.

**11. USB Thumb Drive Insert Dock**

Player accepts drive with up to 16 GB of memory\*\*.

- \* 1. Unit will randomize the order in which playback tracks will take place, however this does not guarantee a selection will not be repeated during the playing time/session.
- 2. Playback will occur in the order the tracks were recorded on to the SD Card or USB Thumb Drive. First recorded selection will be the first selection played, the second recorded selection will play second, and so on.

\*\* With a 16 GB memory card, there will be close to 300 hours of music available or nearly 400 albums (typical).

### LCD Display



# Operation

---

## Bluetooth (for Model CC4062MBT Only)

To setup the amplifier to use Bluetooth input, you need a Bluetooth transmitter. This can be a smartphone, MP3 player, laptop, PC, etc. that supports A2DP stereo music protocol. "CC4062MBT" will show up as the recognized device on the Bluetooth transmitter.

From the moment the power button of the CC4062MBT is turned on, the amplifier's integrated antenna will constantly seek to pair up with a Bluetooth transmitter. Some devices will automatically pair up with the CC4062MBT. If the device does not automatically pair up, it is because the unit requires you to enter a pairing code. When prompted by your device, enter code "1234".

When the Bluetooth LED on the front of the CC4062MBT is blinking, it is trying to make a connection to a Bluetooth transmitter. When the LED is lit steadily, the CC4062MBT has made a connection to a transmitting device and the audio communication will begin.

To set the volume for Bluetooth input, use the volume setting control on the Bluetooth transmitter.

NOTE: The only time the LED indicator is not lit is when the unit is powered off. Otherwise, even if not using Bluetooth, it will blink.



# Cooling

## Ventilation

The amplifier is passively cooled so care must be taken to make cool air available to the amplifier. Do not operate this amplifier in environments that get hotter than 100 deg. F. If the amplifier is to be free standing, do not remove the feet on the amp since they provide a space on the bottom of the amp for cooling air intake. Likewise do not slide books or papers under the amp which will reduce the intake area for the cooling air. Be certain not to place anything on top of the amp which will block the top ventilation slots. Keep anything mounted above the amplifier at least 1.75 inches away.

# Accessories

## Rack Mount Adapter

A rack mount adapter (model RPK93) is available to allow mounting of either a single amplifier or two amplifiers side by side. The amplifier and rack mount adapter use 2 rack spaces (2RU) of height.

NOTE: One (1) rack space both above and below the amplifier will also be needed to ensure proper ventilation.

# Technical Specifications

**Output Power** ..... 40W; 1 kHz @ rated distortion

### Frequency Response

*Balanced LINE/MIC* ..... 100 Hz to 20 kHz; 0/-3 dB

*Unbalanced Input*..... 80 Hz to 20 kHz; 0/-3 dB

### Distortion

*Balanced LINE/MIC* ..... < 1% THD+N

*Unbalanced Input* ..... < 1% THD+N

**Output Regulation** ..... 2 dB or better no-load to full-load

**Output Impedance** ..... 70V, 25V, 4 ohms, 8 ohms

**REC Output** ..... 1.14V @ Full Rated Power (FRP)

**MOH Output** (for CC4052m ..... 8Ω: 1W @ 130 mV (IN 4);  
and CC4062MBT Models Only) 600Ω: 2.1V @ 130 mV (IN 4)

### Maximum Sensitivity

*Balanced MIC* ..... 1.15 mVrms (200 ohms)

*Balanced LINE*..... 70 mVrms (200 ohms)

*Unbalanced RCA Input* ..... 70 mVrms (10k ohms)

*TEL Input* ..... 80 mVrms (600 ohms)

### Maximum Input Level

*Balanced MIC* ..... 100 mVrms

*Balanced LINE*..... 6 Vrms

*Unbalanced Input* ..... 5 Vrms

*TEL Input* ..... 2.2 Vrms

### Signal-to-Noise AUX

*Fundamental* ..... -74 dBr min. referenced to FRP

*Balanced MIC* ..... -59 dBr min. referenced to FRP

*Balanced LINE*..... -70 dBr min. referenced to FRP

*Unbalanced Input*..... -70 dBr min. referenced to FRP

*TEL Input* ..... -70 dBr min. referenced to FRP

### Bass & Treble

*Bass*..... +/- 10 dBr @ 100 Hz  
referenced to mid-band

*Treble*..... +/- 10 dBr @ 10 kHz  
referenced to mid-band

### VOX Trigger & Muting

*Input 1 Trigger Level* ..... 25mV (approx.)

*VOX Release Delay*..... 4 (+/- 1) sec.

*Muting Level*..... > -60 dBr

### TEL Trigger & Muting

*Input 1 Trigger Level* ..... 22mV (approx.)

*VOX Release Delay*..... < 1 sec.

*Muting Level*..... > -60 dBr

### Media Player (for CC4052m & CC4062MBT Models Only)

*Format* ..... MP3 and WMA files

*Type* ..... USB and SD/MMC

*Max. Capacity* ..... 16 GB

### Bluetooth (for CC4062MBT Model Only)

*Range* ..... Up to 30 ft.

*Audio Distribution Profile* .... A2DP

*Antenna* ..... Integrated

*Version*..... Bluetooth 4.0 Compliant

*Pairing Code* ..... 1234

**Phantom Power** ..... 12V DC min., 18V DC max.

**Max. Ambient Temp.** ..... 100 deg. F (non-condensing)

**Thermal Emissions** ..... 141.5 BTU/hr. (full power)

**External Supply** ..... 24V DC; 3A

**Max. Unit Dimensions** ..... 8-1/4" W x 3-1/2" H x 10-3/8" D

**Product Weight**..... 11 lb.

**Listings**..... Listed to UL Standard 60065  
for US and Canada

# Limited Warranty; Exclusion of Certain Damages

The **Bogen CC4052, CC4052m, and CC4062MBT Amplifiers** are warranted to be free from defects in material and workmanship for three (3) years from the date of sale to the original purchaser. Any part of the product covered by this warranty that, with normal installation and use, becomes defective (as confirmed by Bogen upon inspection) during the applicable warranty period, will be repaired or replaced by Bogen, at Bogen's option, provided the product is shipped insured and prepaid to: Bogen Factory Service Department, 50 Spring Street, Ramsey, NJ 07446, USA. Repaired or replacement product will be returned to you freight prepaid. This warranty does not extend to any of our products that have been subjected to abuse, misuse, improper storage, neglect, accident, improper installation or have been modified or repaired or altered in any manner whatsoever, or where the serial number or date code has been removed or defaced.

**THE FOREGOING LIMITED WARRANTY IS BOGEN'S SOLE AND EXCLUSIVE WARRANTY AND THE PURCHASER'S SOLE AND EXCLUSIVE REMEDY. BOGEN MAKES NO OTHER WARRANTIES OF ANY KIND, EITHER EXPRESS OR IMPLIED, AND ALL IMPLIED WARRANTIES OF MERCHANTABILITY OR FITNESS FOR A PARTICULAR PURPOSE ARE HEREBY DISCLAIMED AND EXCLUDED TO THE MAXIMUM EXTENT ALLOWABLE BY LAW.** Bogen's liability arising out of the manufacture, sale or supplying of products or their use or disposition, whether based upon warranty, contract, tort or otherwise, shall be limited to the price of the product. **IN NO EVENT SHALL BOGEN BE LIABLE FOR SPECIAL, INCIDENTAL OR CONSEQUENTIAL DAMAGES (INCLUDING, BUT NOT LIMITED TO, LOSS OF PROFITS, LOSS OF DATA OR LOSS OF USE DAMAGES) ARISING OUT OF THE MANUFACTURE, SALE OR SUPPLYING OF PRODUCTS, EVEN IF BOGEN HAS BEEN ADVISED OF THE POSSIBILITY OF SUCH DAMAGES OR LOSSES.** Some States do not allow the exclusion or limitation of incidental or consequential damages, so the above limitation or exclusion may not apply to you. This warranty gives you specific legal rights, and you may also have other rights which vary from State to State.

Products that are out of warranty will also be repaired by the Bogen Factory Service Department – same address as above or call 201-934-8500. The parts and labor involved in these repairs are warranted for 90 days when repaired by the Bogen Factory Service Department. All shipping charges in addition to parts and labor charges will be at the owner's expense. All returns require a Return Authorization number. For most efficient warranty or repair service, please include a description of the failure.

12/2008

**BOGEN®**  
COMMUNICATIONS, INC.  
[www.bogen.com](http://www.bogen.com)

# BOGEN®

## ADDENDUM TO BOGEN MODEL CC4052m



### CAUTION

Changes or modifications not expressly approved by the party responsible for compliance could void the user's authority to operate the equipment.

This equipment has been tested and found to comply with the limits for a Class B digital device, pursuant to part 15 of the FCC Rules. These limits are designed to provide reasonable protection against harmful interference in a residential installation. This equipment generates, uses, and can radiate radio frequency energy and, if not installed and used in accordance with the instructions, may cause harmful interference to radio communications. However, there is no guarantee that interference will not occur in a particular installation. If this equipment does cause harmful interference to radio or television reception, which can be determined by turning the equipment off and on, the user is encouraged to try to correct the interference by one or more of the following measures:

- Reorient or relocate the receiving antenna.
- Increase the separation between the equipment and receiver.
- Connect the equipment into an outlet on a circuit different from that to which the receiver is connected.
- Consult the dealer or an experienced radio/TV technician for help.

**NOTE:** This product is protected by certain intellectual property rights of Microsoft. Use or distribution of such technology outside of this product is prohibited without a license from Microsoft.

**BOGEN®**  
COMMUNICATIONS, INC.  
www.bogen.com

Specifications subject to change without notice.  
© 2014 Bogen Communications, Inc.  
54-6710-14B 1411

# BOGEN®

## ADDENDUM TO BOGEN MODEL CC4062MBT



### CAUTION

This device complies with Part 15 of the FCC Rules. Operation is subject to the following two conditions: (1) this device may not cause harmful interference, and (2) this device must accept any interference received, including interference that may cause undesired operation.

Changes or modifications not expressly approved by the party responsible for compliance could void the user's authority to operate the equipment.

The equipment has been tested and found to comply with the limits for a Class B digital device, pursuant to part 15 of the FCC Rules. These limits are designed to provide reasonable protection against harmful interference in a residential installation. The equipment generates, uses, and can radiate radio frequency energy and, if not installed and used in accordance with the instructions, may cause harmful interference to radio communications. However, there is no guarantee that interference will not occur in a particular installation. If the equipment does cause harmful interference to radio or television reception, which can be determined by turning the equipment off and on, the user is encouraged to try to correct the interference by one or more of the following measures:

- Reorient or relocate the receiving antenna.
- Increase the separation between the equipment and receiver.
- Connect the equipment into an outlet on a circuit different from that to which the receiver is connected.
- Consult the dealer or an experienced radio/TV technician for help.

**NOTE:** This product is protected by certain intellectual property rights of Microsoft. Use or distribution of such technology outside of this product is prohibited without a license from Microsoft.

**BOGEN®**  
COMMUNICATIONS, INC.  
www.bogen.com

Specifications subject to change without notice.  
© 2014 Bogen Communications, Inc.  
54-6710-16A 1411