

HAL1x Multiprocessor



EXP1x Remote Audio Expansion for the HAL1x



New EXP2x Dante Expansion for the HAL1x



EXP3x Zone Output Expansion for the HAL1x



EXP5x Input Expansion for the HAL1x



EXP7x AEC Expansion for the HAL1x

General Description

HAL is more than just another DSP drag-and-drop system. It has revolutionized system design and installation.

HAL is an expert in room combining, paging and distributed audio systems. This groundbreaking architecture is dimensions beyond any solution in any industry. HAL easily guides even novice users through what used to be complex tasks in just minutes. No intricate matrix mixing or presets are required for room combining and paging. No virtual wiring is required to distribute pages and background music to multiple, even hundreds of zones.

Seamlessly interface HAL to your application with web controls and/or a broad variety of peripheral devices including smart Digital Remotes, a 7-inch programmable touchscreen, Remote Audio Devices (RADs), portable or rack automixers, expansion devices for audio I/O, logic, and Dante™, wall sensors, ambient sensing mics, and an advanced Paging Station. Control HAL functions from a web browser in any smartphone, computer or tablet – including iPads, iPhones, Androids, Samsung, etc. The Event Manager can automate HAL's DSP to date and time.

In addition, the HAL Multiprocessor and Halogen™ software check the status, location, CAT 5 wiring integrity, and that audio is flowing in all peripheral devices, so you know your system is properly connected and ready to go. Does your DSP troubleshoot the cable install for you and offer a “Get on the Plane” indicator

showing you that the installers have finished their job? It should.

Halogen software includes Ethernet control support for third-party control systems such as AMX®, Crestron® and Stardraw Control™, including well-documented examples. Standard TCP/IP set and get ASCII text messages control levels, selectors, presets and toggle software actions. Since the same Halogen software code runs on both Windows® and within HAL hardware, third-party control developers can test all their code using only the Halogen Windows software. Use only software for complete system design and validation. Buy the hardware only when the install date arrives and completely skip needing it early solely for control system programming verification.

Analog audio has always offered “plug it in, it works.” With HAL's modern DSP system, finally digital audio offers “plug it in, it works.” Without IP anything, without DHCP servers, without unblocking ports, without firmware mismatches, without hours (or days?) of bad cable termination or swapped cable-pull troubleshooting, and other troubles caused by Ethernet and other supposedly modern digital audio and control transports.

Download Halogen and design a system now!
rane.com/hal
Applications, installations, and solutions are at
blog.rane.com

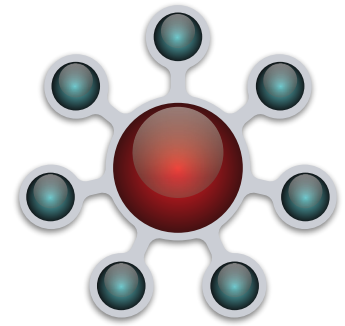

HALOGEN

**With Customizable Web
Browser Controls**

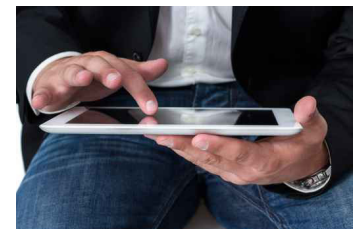

Dante™
EXP2x Expander

HAL1x Multiprocessor

- 16 in x 16 out - 8x8 analog & 8x8 digital (RAD ports).
- Up to 4 RADs (without EXP1x), up to 260 RADs (with 32 EXP1s).
- Up to 12 Digital Remotes (without EXPs), up to 268 (with EXPs).
- Four logic inputs, Two relay outputs (more with DR4 or DR5).

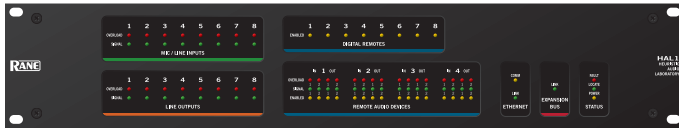

EXP1x Remote Audio Expander for HAL1x

- Adds 16 in x 16 out digital (8 more RAD ports) to HAL1x.
- Up to 8 Digital Remotes or RADs in any combination.
- Chain up to 32 EXP1x units to a HAL1x for 512 in x 512 out.



EXP2x Dante Expander for HAL1x

- Lets HAL1x send and receive 32 channels to a Dante network.
- Supports 44.1, 48, 88.2 or 96 kHz Dante network sample rates.
- Chain up to 16 EXP2x units to a HAL1x for 512 in x 512 out.



EXP3x Zone Output Expander for HAL1x

- Adds 8 analog line outputs and 8 logic outputs to a HAL1x.
- Adds 6 Digital Remote ports & 2 RAD ports to a HAL1x.
- Chain up to 32 EXP3x units to a HAL1x for 256 outputs.



EXP5x Input Expander for HAL1x

- Adds 12 analog mic / line/ line-plus* inputs to a HAL1x.
- Adds 4 Digital Remote ports to a HAL1x.
- Chain up to 32 EXP5x units to a HAL1x for 384 analog outputs.



EXP7x AEC Expander for HAL1x

- Adds 8 channels of Acoustic Echo Cancelling DSP to a HAL1x.
- Chain up to 32 EXP7x units to a HAL1x for 256 AEC channels.



Analog Mic / Line Inputs 8	8 Analog Line Outputs
Digital RAD Port Inputs 8	8 Digital RAD Port Outputs
Digital Expansion into HAL1x 512	512 Digital Expansion from HAL1x
Total in the HAL1x DSP Brain 528	528
Inputs	Outputs

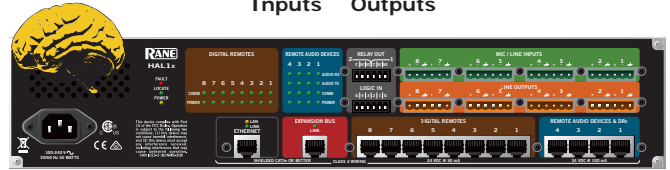

Daisy-chain up to 32 Expanders

More Inputs	More Outputs
Digital RAD Port Inputs 16	16 Digital RAD Port Outputs



More Inputs	More Outputs
Inputs from Dante network 32	32 Outputs to Dante network



More Inputs	More Outputs
Digital RAD Port Inputs 4	8 Analog Line Outputs
	4 Digital RAD Port Outputs

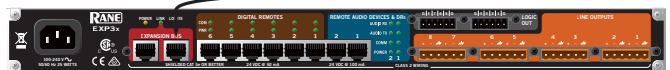

More Inputs
Mic / Line / Line-Plus Inputs 12

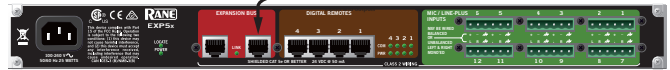

Add AEC



HAL1x Expansion Bus

The HAL1x Expansion Bus supports up to 32 daisy-chained Expanders in any combination. The Expansion Bus requires shielded CAT 5e (or better) cable with RJ-45 connectors.

The bus supports 512 channels in and 512 out, although designers need not worry about wiring channels along the bus — this is automatically done within Halogen software. The Resources window in Halogen displays the number of channels in use and updates as you draw the audio wiring. Latency hops on the bus are 750 nanoseconds per hop. Thus, daisy-chaining 32 Expanders provides a maximum latency of 22.4 microseconds. See the Latency graphic below to add up the latency of any given path through the HAL1x, EXPs, RADs, the DSPs and converters.

Thirty-two Expanders maximum, in any order can be daisy-chained. For example, 16 EXP3x and 16 EXP5x Expanders daisy-chained, provides 128 outputs (8 out times 16), plus 192 mic/line-plus inputs (12 in times 16).

Some examples max out the Expansion Bus:

- If you need 256 RADs, daisy-chain 32 EXP1x Expanders. This is 8 RAD ports times 32 Expanders, $8 \times 32 = 256$ RADs. This still leaves 4 RAD ports available on the HAL1x.

- For 256 output zones, daisy-chain 32 EXP3x Expanders.
- For 384 mic/line inputs, daisy-chain 32 EXP5x Expanders.

Each Expansion Bus cable can be 100 meters long (300 feet). This permits spreading Expanders across different locations or equipment rooms. Yet only a single HAL1x is required at the head-end of the daisy-chain. Star topologies are not supported — do not use Ethernet switches, they will not work. And since the EXP3x & EXP5x contain their own DSP, no DSP resources in the HAL1x device are used; thus adding these devices adds DSP resources to the HAL1x System.

Gigabit Ethernet Media Converts *are* supported. Thus, using multimode fiber, one can separate Expanders up to 2 kilometers (1.2 miles). Singlemode fiber distance goes up to 12 km (7.5 miles). The Expansion Bus is Ethernet Layer 1 only — there are no MAC and no IP addresses involved, therefore dedicated unmanaged media converters must be used.

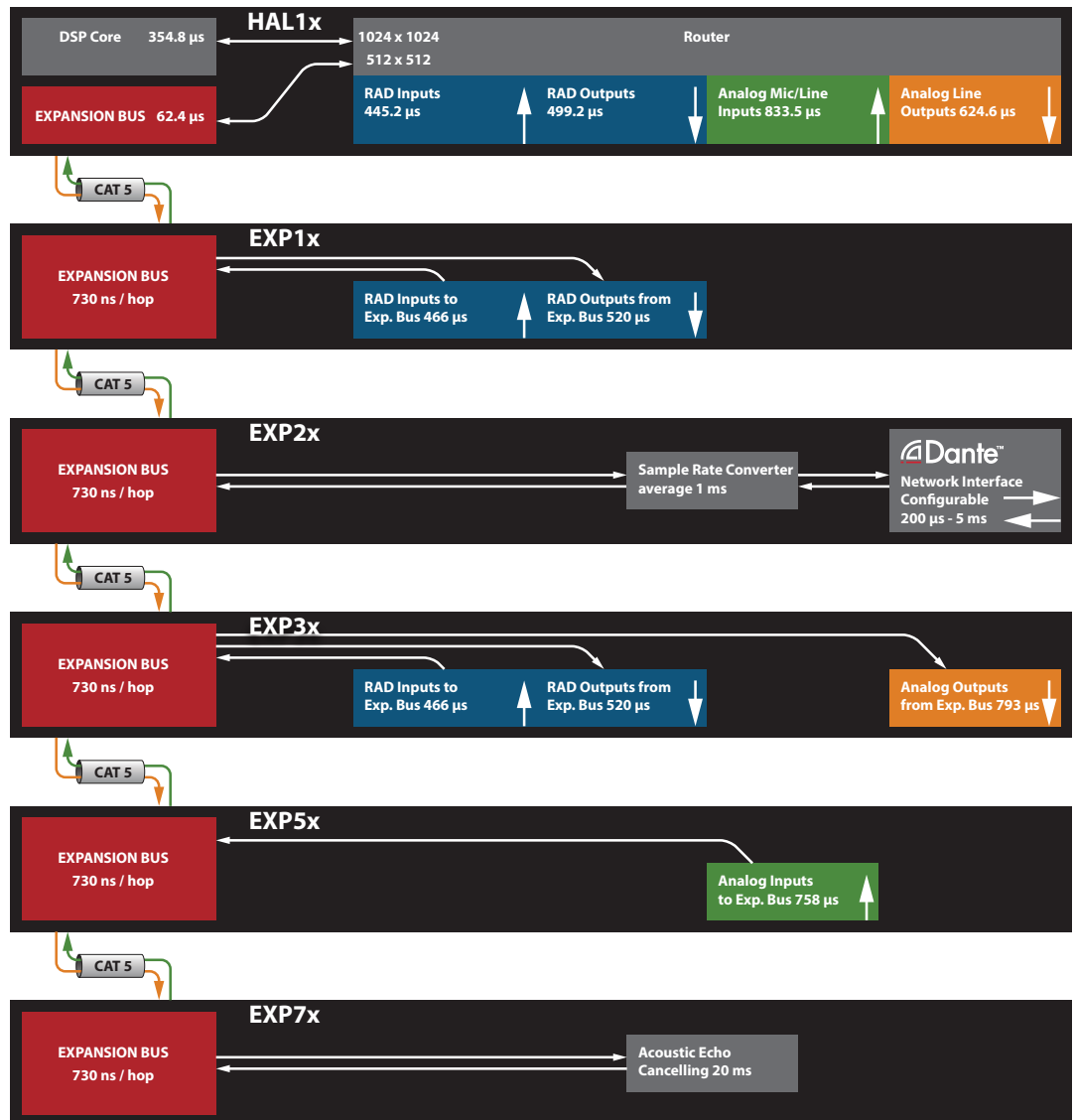

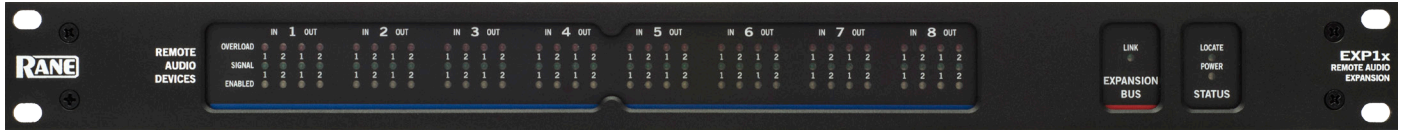

EXP1x Remote Audio Expander

The EXP1x adds eight RAD ports to a HAL1x via the Expansion Bus. The EXP1x requires a HAL1x to operate. Keep in mind that DR remotes are also supported on any RAD port, so the EXP1x also adds support for additional DR remotes when needed. The graphic below shows most of the broad range of RADs and DRs that connect with shielded CAT 5 cable.

Up to 32 Expanders, in any combination, may be daisy-chained to a single HAL1x. 512 inputs and 512 outputs are possible if all 32 are EXP1x units. An example system is shown on the next page. The original HAL1 and EXP1 are replaced with the HAL1x and EXP1x, using the new improved CAT 5 expansion bus. See the "EXP1x Specifications" on page 22.

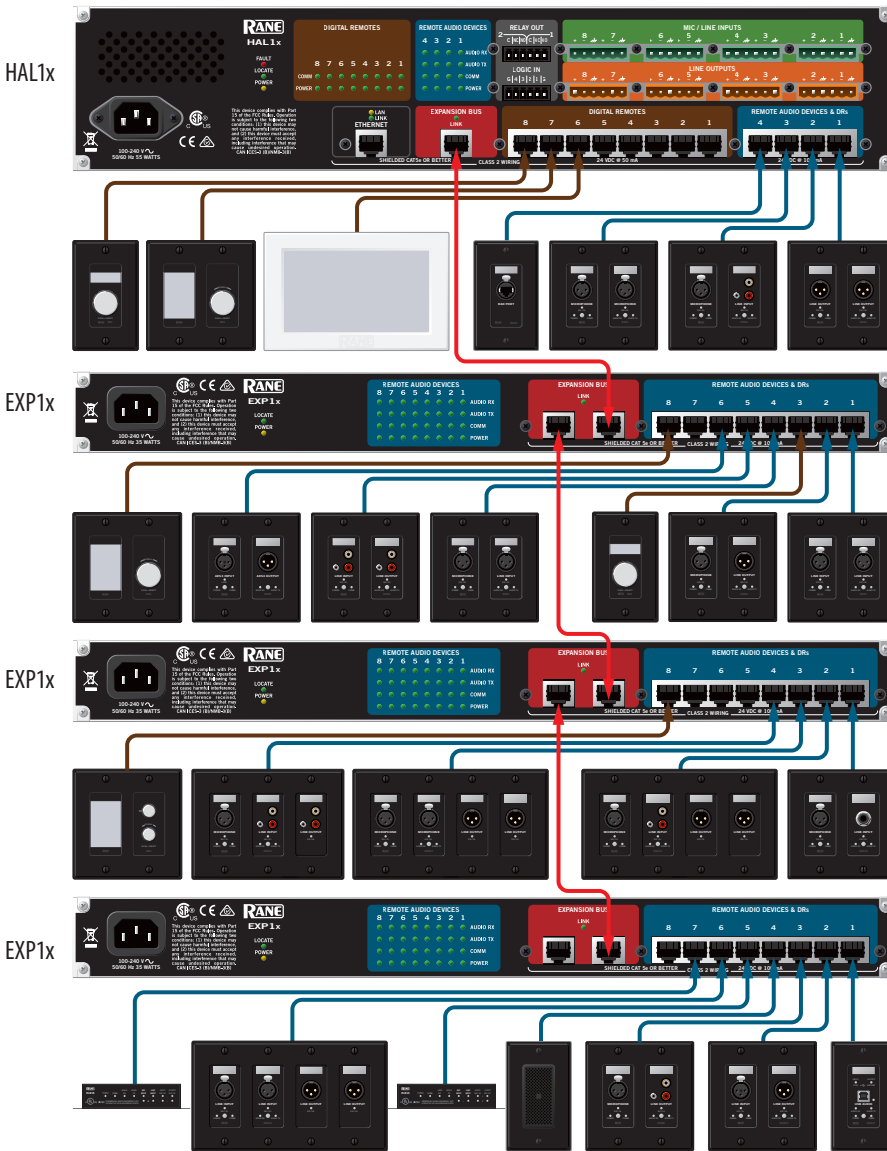

DRs

- DR1 Digital Volume Remote
- DR2 Digital Selection Remote
- DR3 Digital Volume and Selection Remote
- DR4 Logic I/O Expander
- DR5 Switch Controller Remote
- DR6 Touchscreen Controller Remote

RADs

- RAD1 Dual XLR Mic Inputs
- RAD2 XLR Mic Input / Mini & RCA Mono'd Line Input
- RAD3 Dual XLR Line Inputs
- RAD4 Dual XLR Line Outputs
- RAD5 AES3 Input / AES3 Output
- RAD6 Mini & RCA Stereo Line Input / Stereo Line Output
- RAD7 XLR Mic Input / XLR Line Input
- RAD8 XLR Mic Input / Mini & RCA Stereo Line Output
- RAD9 XLR Mic Input / XLR Line Output
- RAD11 XLR Mic In / Mini & RCA Mono'd Line In / Mini & RCA Stereo Line Out.
- RAD12 Dual XLR Mic Inputs / Dual XLR Line Outputs
- RAD14 XLR Mic In / Mini & RCA Mono'd Line In / Dual XLR Line Out.
- RAD15 Dual XLR Line Inputs / Dual XLR Line Outputs
- RAD16z Dual Mic-Line-Plus Input / Dual Line Output / Dual Logic / Euroblocks in a Plenum-Rated Box.
- RAD17 Omnidirectional Boundary Layer Mic
- RAD18 XLR Mic Input / 1/4" Balanced Line Input
- RAD23 XLR Line Input / XLR Line Output
- RAD27 USB Audio Sound Card
- RADX RAD Port Extension (CAT 5 jack for portable RADs)
- AM1 Four-Channel Gain-Sharing Automixer with additional Line Inputs
- AM2 Eight-Channel Gain-Sharing Cascadable Automixer
- PAGER1 Mic Preamp with Push-to-Talk and Zone Select

Example HAL1x with EXP1x Expander

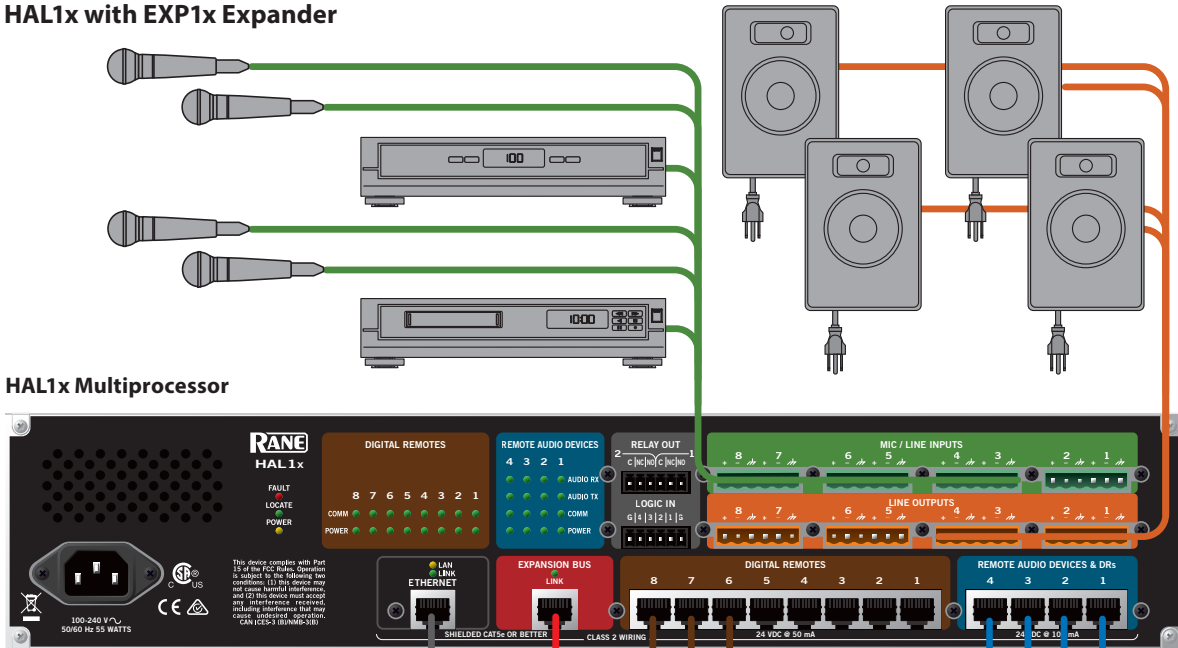

Halogen Software for System Setup

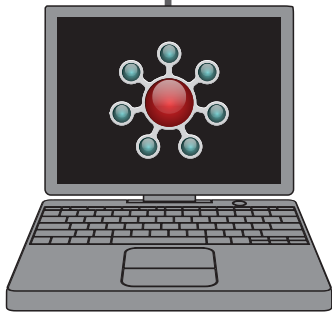

EXP1x Remote Audio Expansion (up to 32 to a HAL1x)

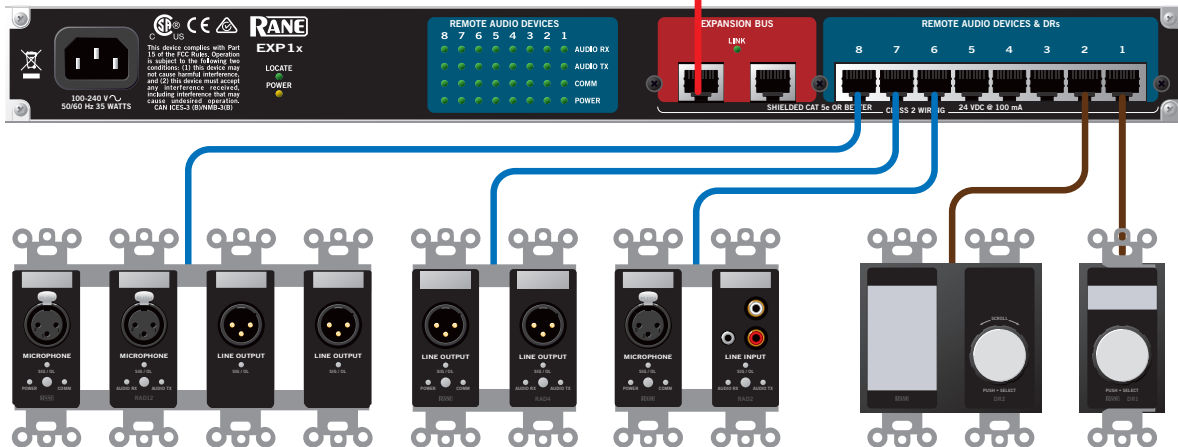

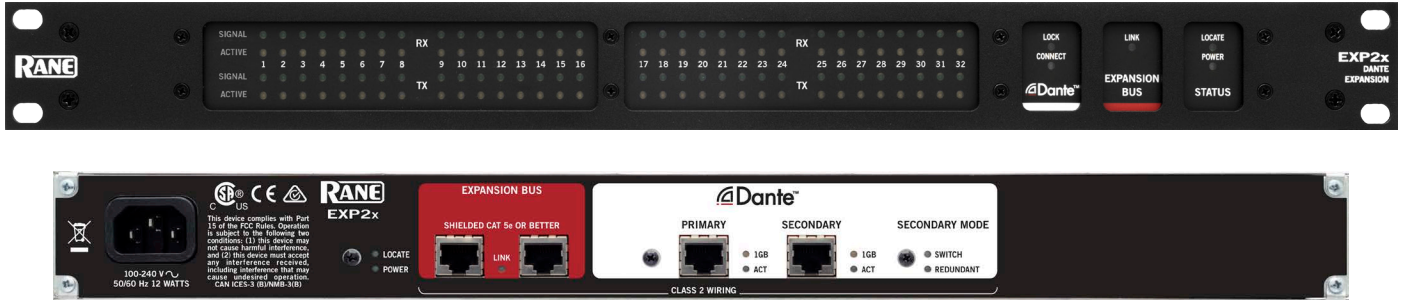

NEW! EXP2x Dante Expander

The EXP2x is an input/output expander that enables the HAL1x to transmit 32 and receive 32 audio channels from a Dante™ network. Applications abound in houses of worship, installed sound, performing arts venues, education and corporate environments – anywhere a Dante network is used. The EXP2x also allows connecting a Dante network between multiple independent HAL1x systems.

Built-in sample rate converters convert the 44.1, 48, 88.2 or 96 kHz sample rate on the Dante network to the HAL’s 48 kHz clock domain.

Daisy-chain up to 16 EXP2x Expanders to a single HAL1x to max-out at 512 x 512 channels on both a single cable on the Dante network and the HAL1x’s Expansion Bus. The HAL1x is capable of 32 Expanders on its bus, so the EXP2x can be combined with other Expanders. For example, use 16 EXP2x Expanders with 512 input and 512 output channels, and then put on another 16 EXP3x Expanders for more outputs.

The EXP2x is equipped with a Secondary Dante port for either Redundant Mode or Switch Mode. Use Dante Controller software for all network audio and EXP2x settings via its Brooklyn II card.

Front panel and Halogen software indicators for Dante connection, network status, flow active, and audio signal present aid troubleshooting. Dante Controller provides all network setup, monitoring, control, diagnostics and troubleshooting beyond compare; while Halogen reads, but does not edit the Dante setup, simplifying which software to use and eliminating conflict.

Dante provides a no-hassle, self-configuring network with ultra-low latency, while providing a true plug-and-play digital audio network using standard Internet Protocols on existing infrastructure — without requiring a dedicated network. The technology is built on global networking standards, making signal distribution more flexible, cost-effective and user-friendly and has been used at some of the largest live events and sophisticated installations worldwide.

See the EXP2x Specifications on page 22.

Read Rane’s Dante Setup Philosophy under the EXP2x tab at rane.com/hal/hal1x.html.

Features

- Supports 44.1, 48, 88.2 or 96 kHz Dante network sample rates.
- Up to 32 transmit channels and up to 32 receive channels (at any supported sample rate - that’s right, even at 96 kHz).
- 32 bi-directional channels of high-quality sample rate conversion.
- Switch Mode and Redundant Mode for the Secondary Dante network port.
- Clear signal presence and fault status indication in Halogen Software and on the EXP2x front panel.
- Discoverable and configurable using Dante Controller software.

What Ethernet switch can I use for my Dante network?

Answers to this and many other Dante questions are found at audinate.com/resources/networks-switches. The Cisco 300 Series Ethernet switches are available in many varieties, such as the 10-port, SG300-10. They are very affordable, managed, and some offer PoE versions if needed. If you use an Ethernet switch with “Green” Energy-Efficient Ethernet (IEEE 802.3az) turn off this feature. This green technology can delay packets hundreds of milliseconds which will stop all Dante audio from working.



About Audinate

Audinate revolutionizes AV systems to enable its customers to thrive in a networked world. Audinate’s patented Dante media networking technology has been adopted by the leading manufacturers in the professional audio/visual industry. Dante is used extensively for live performance events, commercial installation, broadcast, recording and production, and communications systems. Audinate offices are located in US, United Kingdom and Australia. Visit www.audinate.com for the latest news and information on the company. Dante is Digital Media Networking Perfected.

*Dante is a trademark of Audinate Pty Ltd.
Audinate is a registered trademark of Audinate Pty Ltd.*

Example using a Dante network with the EXP2x, console, microphones and amplifiers.

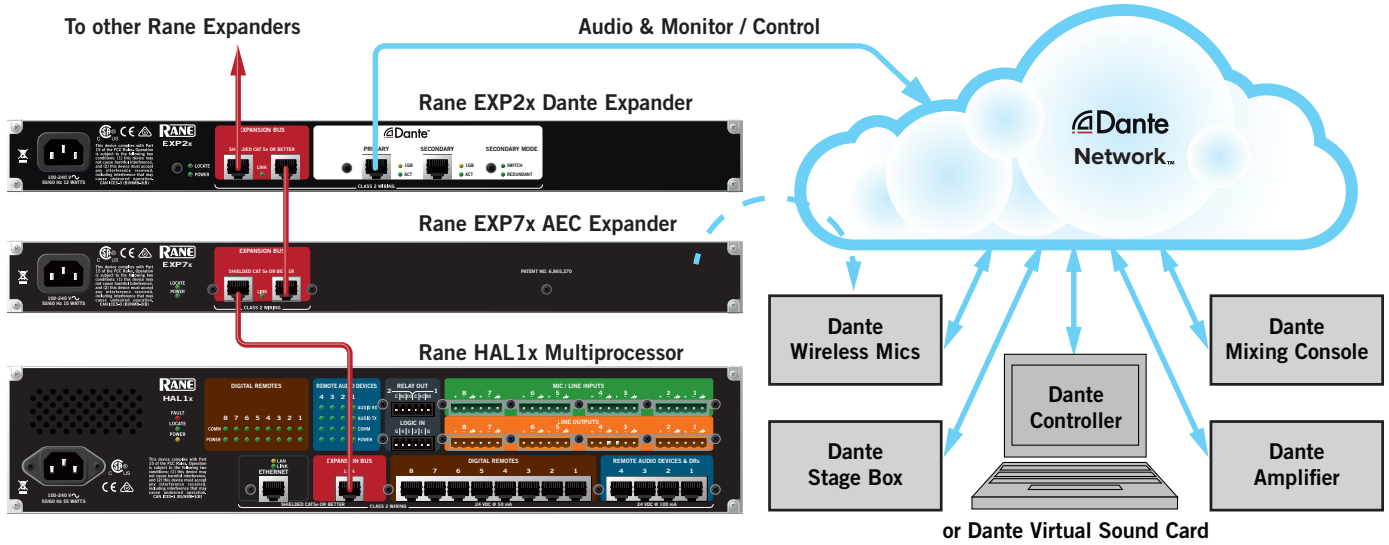

A Rane HAL system supplies DSP for distribution and sound reinforcement, while adding AEC to Dante wireless mics. This is an excellent way to add AEC to Shure's Dante products.

Example Connecting 2 HAL Systems through the EXP2x

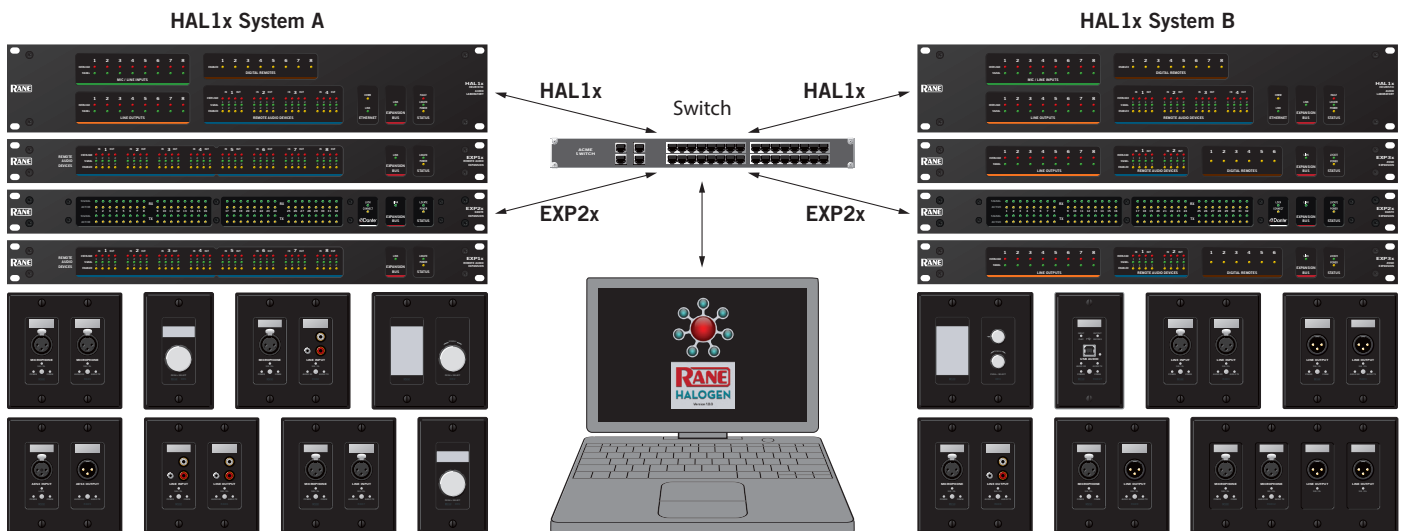

EXP2x Expanders allow two independent HAL systems to share audio channels through an Ethernet switch.

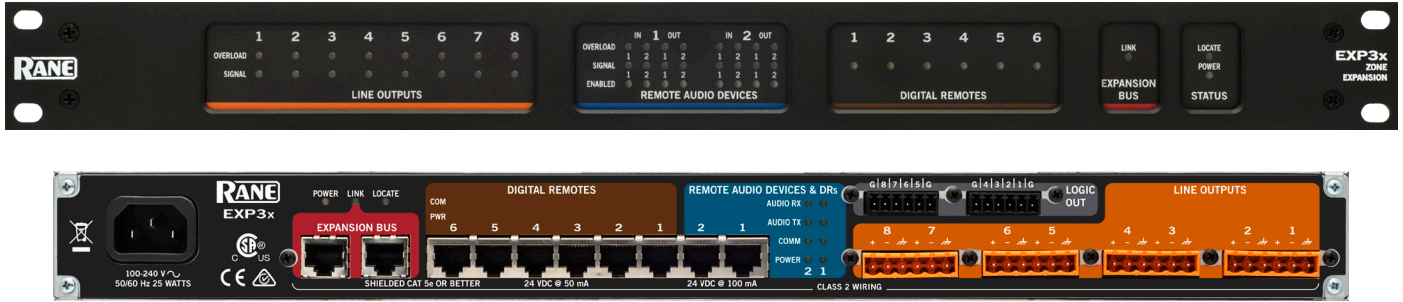

EXP3x Zone Output Expander

The EXP3x is an 8-channel analog output & DSP expander for the HAL1x, which is required for operation. It also sports eight logic outputs, six DR remote ports and two RAD ports making a 4-input, 12-output audio device — depending on which two RADs are connected. Thus, 32 daisy-chained EXP3x Expanders provide 256 discrete zone outputs maximum, including output compression, parametric EQ, two levels of paging and background music. These 32 EXP3x Expanders would also provide 64 RAD ports, 192 DR ports and 256 logic outputs.

The dedicated DSP for each of the eight analog outputs offers two signal processing choices independently selectable per output. When you need background music, paging and emergency paging on an output, select the Zone Output processing set. This provides a Zone Processor block, an Emergency Zone in addition to a Compressor and a 5-band parametric EQ with high- and low-cut filters. When Line Output is selected, the compressor and parametric EQ are available without the zone processing block and emergency paging blocks. See the "EXP3x Specifications" on page 23.

EXP3x Application Example

Each EXP3x provides full support for an 8-zone cluster without consuming HAL1x DSP, DR or RAD resources. All of the DSP required for paging, distributed background music selection, PEQ, dynamics and Level control is included in the device. DR and RAD resource also scale with the device with provision for 6 DR ports and 2 RAD ports.

For example, a single DR3 remote in a manager’s office or rack room can provide independent level for all 8 outputs from the EXP3x. Selection and level within 5 different zones is available using 5 DR3 remotes. The first RAD port allows local zone sources such as a page or podium mic, plus a laptop feed when using a RAD2. Or, as shown on the facing page, a Rane PAGER1 Paging Station(A) instead supplies paging throughout many zones. Perhaps the weekend DJ or band needs to plug a mixer into the wall and automatically or manually override the background music with a DR remote. A RAD3 in the second EXP3x’s RAD port (B) provides balanced XLR line-level inputs to the system for the DJ or band mixer.

The logic outputs on the EXP3x are suited for legacy paging systems where relays within each zone’s 70/100 volt volume controls must be tripped during a page. Simply link the Logic Out to a Page Active in the Halogen Paging Manager, and use a Logic Out to drive a relay. This turns up the remote’s volume during pages. With eight logic outputs, eight zones of old-school constant-voltage paging are supported.

Pushing the EXP3x Zone Output Expander

If your application requires eight floors of combined retail and office space, where each floor contains eight zones, the EXP3x is clearly a winning solution with one HAL1x. This would support 64 zones, a handful of building-wide global background music channels connected to the HAL1x directly, paging via PAGER1s within individual or even across a few floors, plus a couple of local-only audio sources per floor. Add up to 58 DR remotes, one or two RADs per floor, and you’re done. You can even spread the EXP3x Expanders across different equipment rooms using dedicated shielded CAT 5e cable runs, as long as they don’t exceed 100 meters (300 feet). Use standard unmanaged Ethernet Gigabit Media Converters within the daisy-chained Expansion Bus to achieve distances up to 12 kilometers, or 7.5 miles.

In existing room combine facilities, the EXP3x slots ahead of the amplifiers to upgrade existing systems.

EXP3x Background Music and Paging Application Example

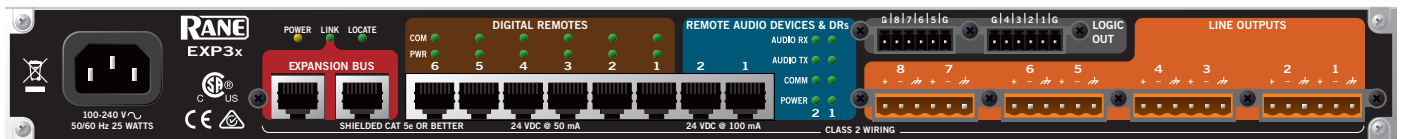
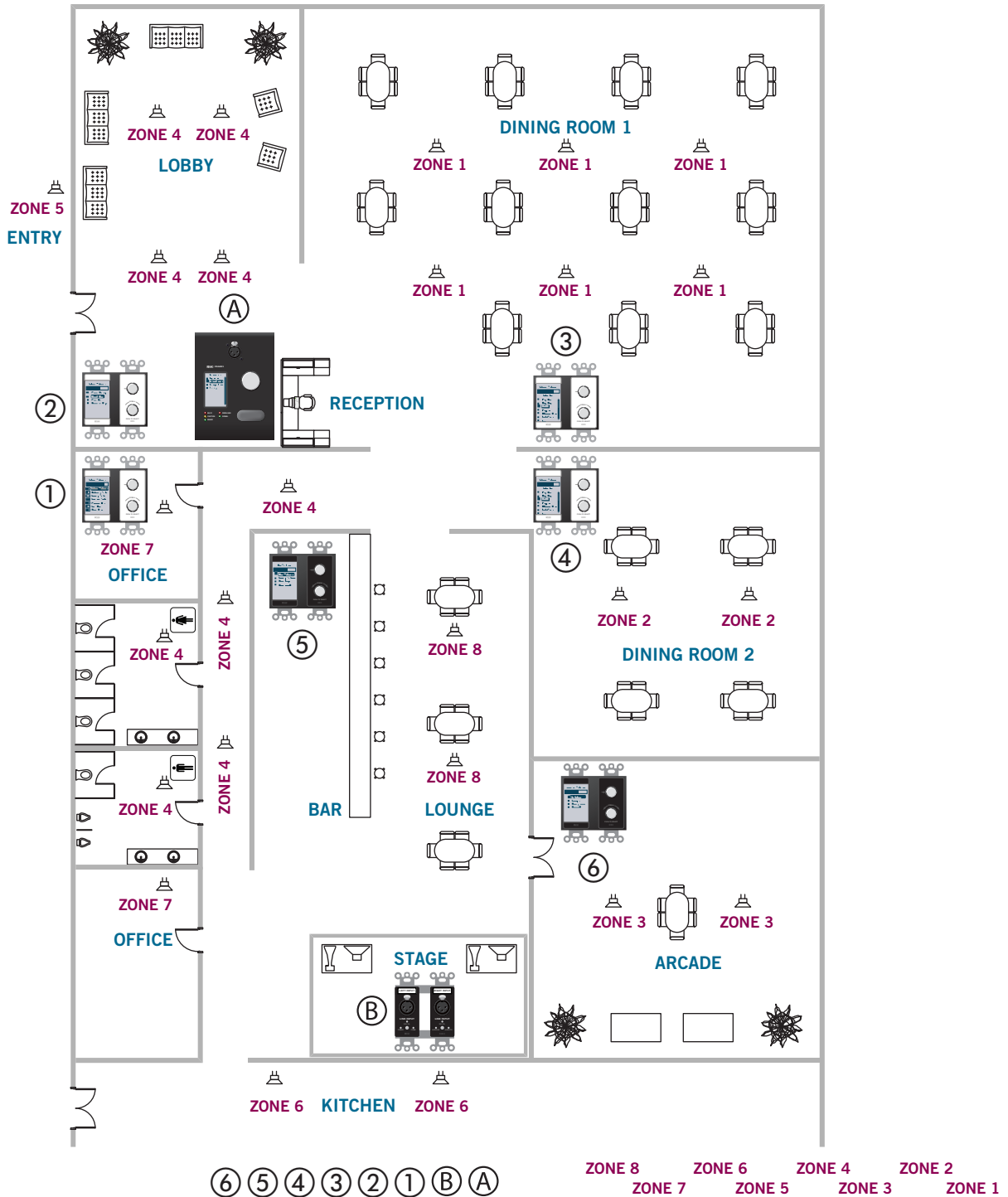



EXP5x Input Expander

The EXP5x is a 12 Mic/Line/Line-Plus input & DSP expander for the HAL1x. It also supplies four DR ports, useful for adding source selection and/or volume control remotes such as the DR3. Each of the 12 inputs independently supports either dynamic mic, 48V phantom mic, +4 dBu line-level, or Rane’s Line-Plus input. Line-Plus accepts -10 dBV unbalanced Left/Right Monoed

together on the “+” and “-” ports, respectively. For stereo unbalanced sources, Line-Plus allows connecting the stereo RCA left tip conductor to the “+” terminal, the RCA right tip to the “-” terminal, and both RCA shields to the EXP5x Euroblock ground. Select Line-Plus in Halogen and you get a properly monoed audio channel. See the "EXP5x Specifications" on page 24.

EXP5x Application Example

The EXP5x is perfectly suited to expand a HAL1x’s analog audio inputs. Control is also expanded given its 4 DR ports. Each of the 12 inputs can independently accept mic, line, or Line-Plus audio — the ultimate in flexible input topologies. Also worth noting is the performance enhancement achieved since the mic input topologies automatically compensate for the sensitivity difference between condenser and dynamic mics.

In a meeting room with ten microphones (see graphic), one audio source (e.g., blu-ray) and a laptop on the podium, all these channels can connect directly to one EXP5x. A single DR3 in the room can select the audio source (blu-ray or laptop) and adjust the room volume. Or, the DR3 can be programmed as a mixer allowing independent level adjustment of all 12 sources in the room: 10 mics, blu-ray and laptop. If the podium location moves from the north to the east wall, duplicate remotes can provide multiple control locations. Use a preset recalled from a switch closure, DR2 remote or 3rd-party Ethernet control system to “spin” the room or disable any DR remote in a room.

There are equipment placement options. If the HAL1x lives in the equipment room, the EXP5x can live in the podium along with the blu-ray, and a single shielded CAT 5 returns to the HAL1x. However, if you are upgrading an existing facility, the EXP5x connects at the end of the existing analog conduit feeds in one or more equipment rooms.

If you had 12 such meeting rooms, use 12 daisy-chained EXP5x Expanders and a single HAL1x. The accompanying illustration shows only four such rooms. There would be plenty of spare DR ports available for adding control locations. The four RAD ports on the HAL1x support the addition of page sources (e.g., PAGER1) or portable 8-channel AM2 Automixers. AM mixers can be added to larger rooms - even during a meeting - to add 8 more gain-shared mixed mics to the 10 in any given room. Review the Cascade In feature of the Gain-sharing Auto Mixer or the Room Combine Processing blocks within Halogen for details.

EXP5x Meeting Room Combine Application Example

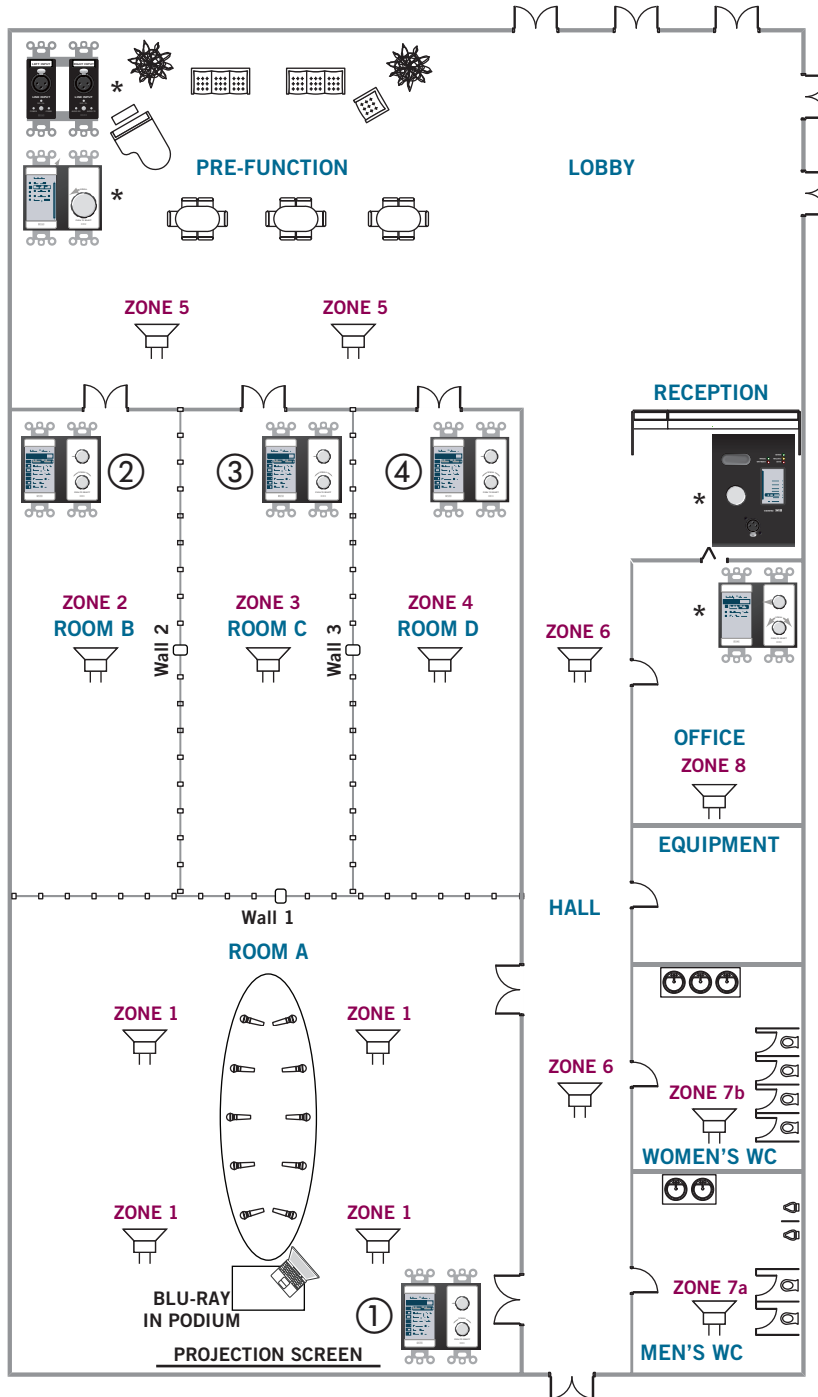

* These RADs and DRs connect to the main HAL1x.
Zones are fed by the main HAL1x.



ROOM A, MICS 1-10, LAPTOP, BLU-RAY

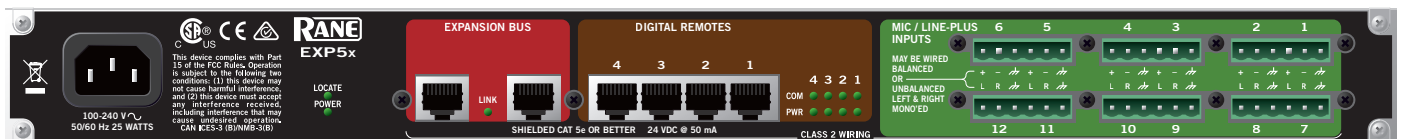



EXP7x AEC Expander

The Rane EXP7x Expander for the HAL1x provides 8 channels of full-featured, drag and drop Acoustic Echo Cancellation (AEC). Each channel of AEC can be added to any HAL1x system input and route to any Halogen DSP block, including the gain-sharing automixer, manual mixer, regular Room Combine block, new Conference Room Combine block.

The Rane EXP7x in combination with HAL1x and Halogen software provides a conferencing solution including far more than high-performance AEC.

Processing blocks to enhance the AEC system solution:

- Revolutionary Conference Room Combine block with intrinsic support for conferencing.
 - Independent Far End mixers and AEC Reference output per room.
 - Far End gain-sharing mixer inputs and AEC reference feeds automatically change with each room combination.
- Conference Switchboard DSP Router (see page 11)
 - Multichannel and Tracking processing blocks mirror local room processing in the AEC Reference signal path.
 - Included are the Multichannel Shelving Filter, Multichannel PEQ, Tracking Ambient Noise Compensation and Tracking Side-chain Compressor.

Each AEC channel includes:

- Mic and Reference Inputs with Level control & metering.
- AEC on/off, plus adjustable AEC Threshold.
- Soft / loud talker AGC & 5-band parametric EQ, plus high- and low-cut filters.
- Full bandwidth AEC with adjustable non-linear processing.
- Ambient Noise Reduction (dynamic & steady-state) & howling prevention.
- Complete metering: Input, Reference, Echo Return Loss (ERL), Echo Return Loss Enhancement (ERLE) & Total Echo Return Loss (TER).
- 20 to 20 kHz Bandwidth, 300 ms tail length.
- <17 ms propagation delay, 100 dB/sec convergence rate.

Because EXP7x AEC channels are not associated with a particular hardware input, preset recall can re-assign an AEC resource across inputs / rooms as required. Drag and drop AEC supports the typical one-AEC-per-microphone configuration. With optimum acoustics, mic and loudspeaker placement, or with rarely used mics (such as audience mics) it allows mixing more than one mic into a single AEC channel, significantly reducing cost.



What's unique about HAL's AEC?

- Flexible drag-and-drop AEC placement.
 - Use it where you need it, on any HAL System input.
 - Re-route AEC resources with presets: re-use AEC across rooms.
- Intrinsic support for conferencing with advanced supporting processing blocks:
 - Conference Room Combine block.
 - Conference Switchboard.
- Multi-channel processing blocks mirror room processing in the reference signal path.
- High-Level, inherent conferencing support through.

See the EXP7x Specifications on page 25.



Conferencing Application

The application above has a number of microphones used in a room with overhead sound reinforcement. In this type of system, sound reinforcement is typically strengthened and delay compensation added as a loudspeaker gets further from the original source.

In this scenario, if room acoustics are good, it is possible to use a single AEC processing block for more than one microphone by combining microphones in a common reinforcement zone. The drag-and-drop flexibility of EXP7x AEC blocks lets you add AEC to any Halogen system input.

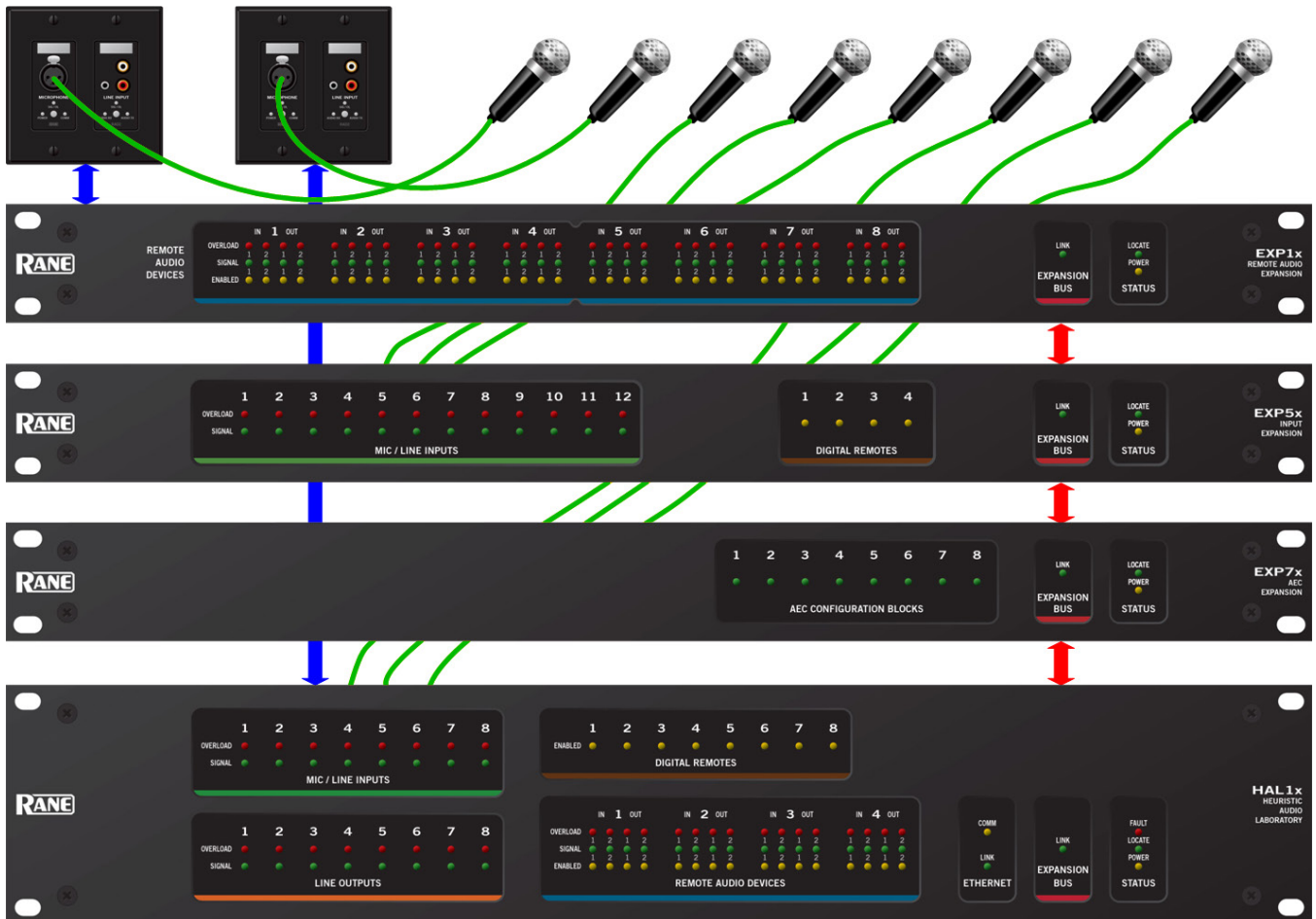

RADs

The entire family of RAD models interface with HAL, for digital conversion at the wall. Each converts analog audio to and/or from 24-bit, 48 kHz digital audio. Shielded CAT 5e (or better) cable and termination transport four digital audio channels – two channels each direction – as well as power, ground and a communications channel, with status indicators at each RAD, HAL or EXP unit, and in Halogen software. HAL auto-checks the CAT 5 crimp and verifies audio. All RADs (and DRs) are both “location-aware” and hot-swappable with 150 meter (500 feet) homerun connections (66% farther than Ethernet). Light sensors dim the RAD indicators in dark rooms. Except for the RAD16z, AM1, AM2, and PAGER1, all RADs mount in standard US electrical boxes. Except for the RAD16z, RAD17, AM1, AM2, and PAGER1, all other RADs are available in white, ivory, or black, with a matched Decora® plate cover included.

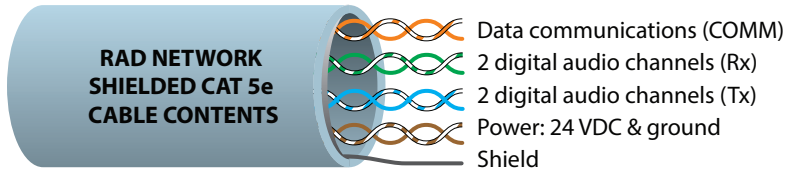

- RAD1 Dual XLR Mic Inputs
- RAD2 XLR Mic Input / Mini & RCA Mono'ed Line Input
- RAD3 Dual XLR Line Inputs
- RAD4 Dual XLR Line Outputs
- RAD5 AES3 Input / AES3 Output
- RAD6 Mini & RCA Stereo Line Input / Stereo Line Output
- RAD7 XLR Mic Input / XLR Line Input
- RAD8 XLR Mic Input / Mini & RCA Stereo Line Output
- RAD9 XLR Mic Input / XLR Line Output
- RAD11 XLR Mic In / Mini & RCA Mono'ed Line In / Mini & RCA Stereo Line Out
- RAD12 Dual XLR Mic Inputs / Dual XLR Line Outputs
- RAD14 XLR Mic In / Mini & RCA Mono'ed Line In / Dual XLR Line Out
- RAD15 Dual XLR Line Inputs / Dual XLR Line Outputs
- RAD16z Dual Mic-Line-Plus Input / Dual Line Output / Dual Logic / Euroblocks
- RAD17 Omnidirectional Boundary Layer Mic
- RAD18 XLR Mic Input / 1/4" Balanced Line Input
- RAD23 XLR Line Input / XLR Line Output
- RAD27 USB Audio Sound Card
- RADX RAD Port Extension (CAT 5 wall jack for portable RADs)
- AM1 Four-Channel Gain-Sharing Automixer with added Line Inputs
- AM2 Eight-Channel Gain-Sharing Cascadable Automixer
- PAGER1 Mic Preamp with Push-to-Talk and Page Zone Selection

**PAGER1
Paging Station**

This RAD has a mic preamp, paging zone(s) [Scenario] selector and an integrated push-to-talk switch. It sits on or can fasten to a tabletop, and accepts any gooseneck microphone (not included).

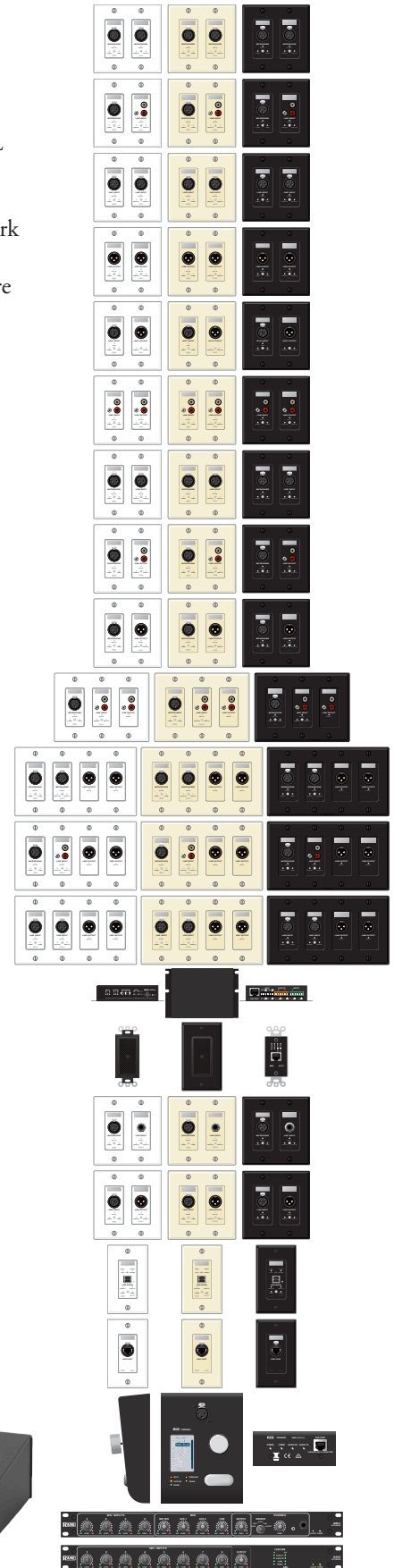
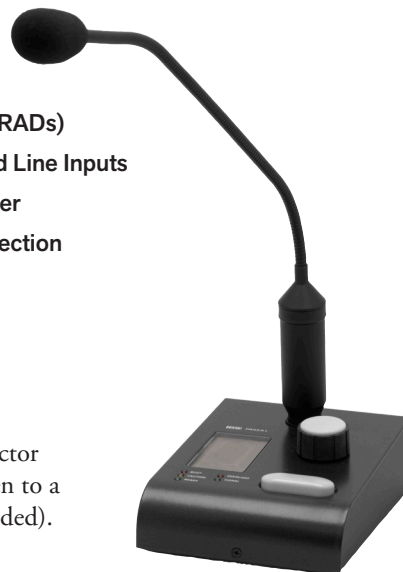

Digital Remotes

Three Digital Remotes simplify end user control and eliminate installer brain fatigue. Use Digital Remotes for volume control, preset recall, source selection, or resetting or toggling system states. All offer customizable backlit LCD screens for intuitive end user labeling. Home run shielded CAT 5e (or better) connections to a HAL or EXP eliminate addressing, external power, and the need to test the cables.

The DR1 supports Level Control.

The DR2 offers Single Selector or List of Toggles/Commands behavior.

The DR3 has three behaviors: Single Level & List of Toggles/Commands, List of Levels for either multizone volume control and/or input source mixing, and Single Level plus Selector.

DR1 Digital Volume Remote



Level Control

DR2 Digital Selection Remote

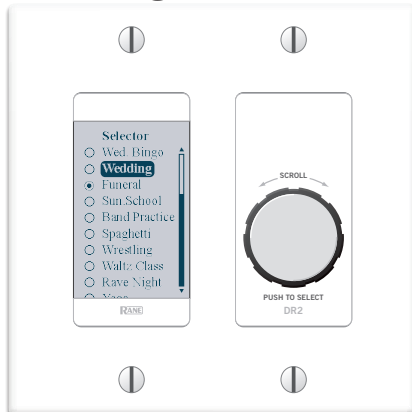

Single Selector

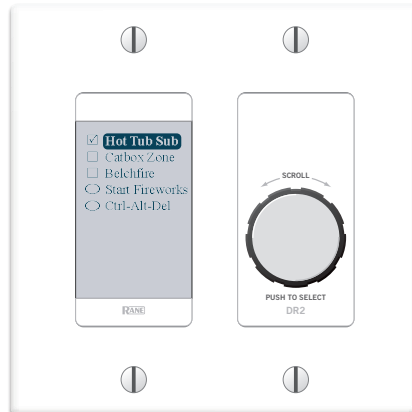

List of Toggles / Commands

DR3 Digital Volume and Selection Remote

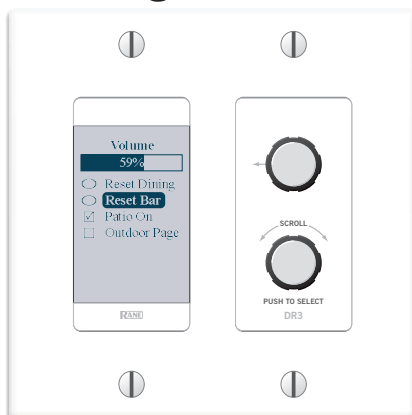

Single Level & List of Toggles / Commands

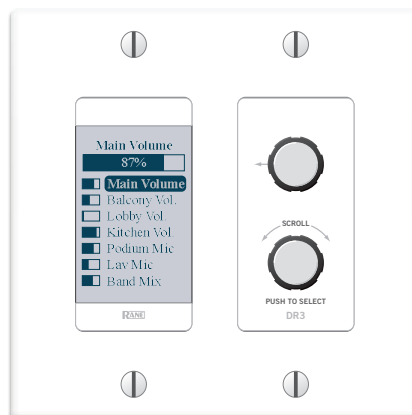

List of Levels

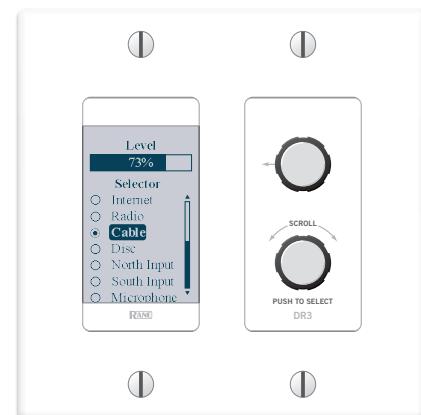

Single Level & Selector

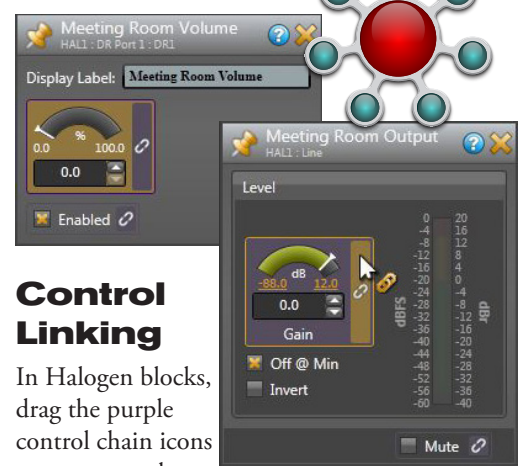

Control Linking

In Halogen blocks, drag the purple control chain icons atop one another to create links between Levels, Toggles, Selectors, Commands, Digital Remotes, Web Controls and/or 3rd-party controls. The above screen shows linking a DR1 volume onto the Meeting Room Output Level control. Four Control Link types and behaviors are supported: Level, Select, Toggle or Command. Activation and Priorities work together for incredible flexibility. Link simple analog remote level controls, contact closures and IR remote wall sensors by adding a DR4 Logic I/O Expander.

DR4 Logic I/O Expander

The DR4 Digital Remote adds additional logic input and output ports to any HAL, enabling simple analog level and logic I/O controls plus IR2 remotes for wall sensing. The DR4 offers eight logic ins and outs, six IR ports and eight analog input ports for

pot-on-a-wall level control. Multiple DR4's can connect to Digital Remote Ports on any HAL, up to 300 meters (1000 feet) away. See the Logic Inputs, Control Inputs and Logic Outputs on the next page. See the IR2 Sensors in the HAL System Data Sheet.



DR5 Switch Controller Remote

The DR5 Digital Remote offers additional logic input and output ports, enabling the use of simple analog switch controls in any HAL system. Lighted switch panels for room combine applications are easily integrated into a HAL system using the eight switch inputs and eight LEDs outputs on the DR5. Unlike the HAL and DR4 Logic I/O, the DR5 Logic Out is intended to drive the LED indicator on a room combine panel, and is a writable parameter. The DR5 is designed to fit in a standard US dual-gang electrical box or mount directly near a room combine panel.

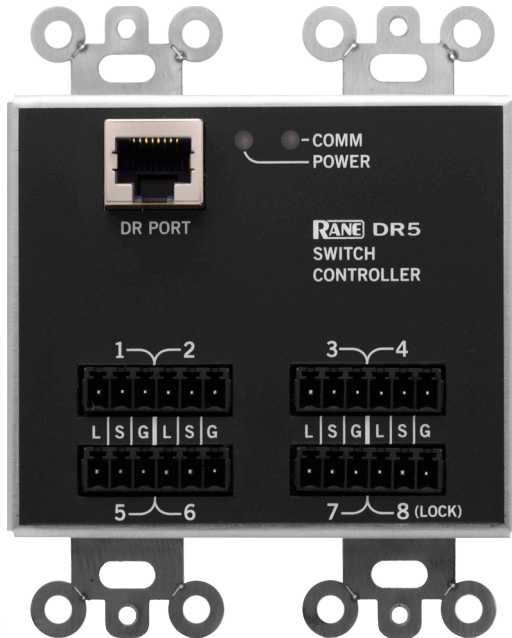
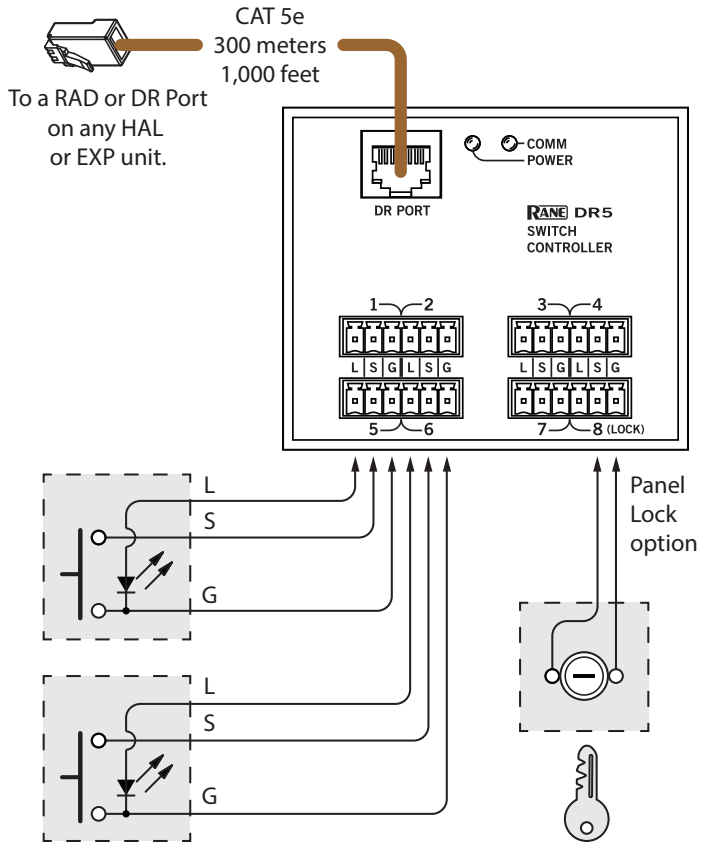

HAL1x Logic Inputs

These inputs are found on the HAL1x. More can be added with the DR4 or DR5, connectable to any DR port. You can configure each of the Logic Input ports in one of three ways: toggle, command, or selector.

The **Toggle** configuration allows a Toggle command with an on/off switch. You can configure each port type to be either *Momentary* or *Latching*.

The **Command** configuration allows triggering a Command control from an on/off switch, which can link to one or more Command controls such as a Command preset or a linkable button in a processing block property dialog.

The **Selector** configuration uses either a multi-position switch or a binary switch. You can connect a physical device to any or all of the Logic In ports and configure the ports in Halogen so they make the desired selection according to the state of the physical device. Wiring details are in the Halogen Software Help. The Selector configuration is not supported by the DR5.

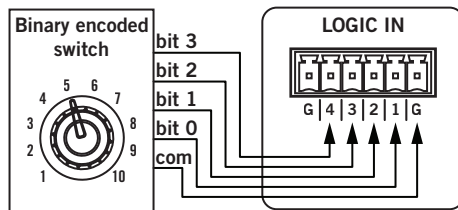
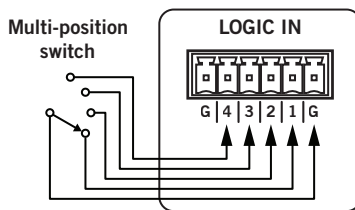
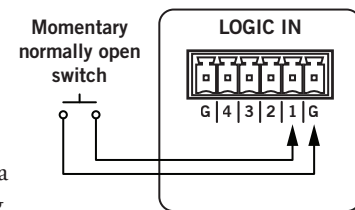

Analog Control Inputs

These inputs are found on the DR4 that can connect to any HAL. Each port allows an analog voltage source to control the value of a Level control in the Halogen Control palette. The input range for the port is from 0 V to 5 V, where 0 V corresponds to 0% on the associated Level control and 5 V corresponds to 100%.

Connect a physical linear-taper potentiometer, like the Rane VR2 Volume Remote. The Vc wiper provides the control voltage to the DR4. As you adjust the pot the voltage changes, which in turn changes any linked Level control in Halogen.

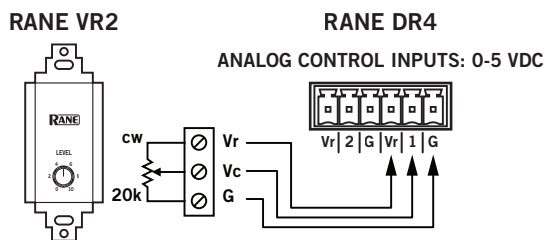

Logic Outputs

These outputs are found on the EXP3x Output Expander for the HAL1x, or on a DR4 that can connect to any HAL. You can configure each of the 8 output ports in one of 2 ways:

- **Toggle:** When a toggle control in the Halogen Control palette is unchecked, HAL sets the corresponding DR4 Logic Out port to logic high (5 V), and when the toggle is checked, it sets the port to logic low (0 V).
- **Selector:** When a selector control in the Halogen Control palette is set to the first selection, HAL sets the corresponding DR4 Logic Out port to logic high (5 V). Conversely, when the selector control is in the second position, HAL sets the port to logic low (0 V).

HAL1x Relay Outputs

These reed relay ports are found on the HAL1x to signal other devices. A common implementation is to link a relay port to a Toggle control so an end user can change its value. Halogen software contains a checkbox for each relay port. Its value can be included in a preset or link to another control, making it possible to use a preset or control to turn the relay port on or off.

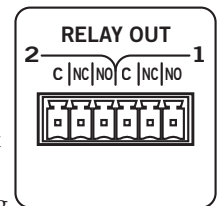

AMX, Crestron and Stardraw Support Packages

These Control System Guides include an introduction to external control systems with HAL. Each appendix includes reference information on the HAL external control message protocol and how to use a telnet client to monitor and troubleshoot control system operation. Each package has an example HAL1x configuration and how to set up a controller for each touch panel to communicate with a Halogen/HAL Control Server.

The Support Packages are installed with the Halogen software and can be accessed from the Windows Start Menu under Rane Corporation > Halogen > Guides > AMX, Crestron or Stardraw.

★ NEW! DR6 Touchscreen Remote

The new DR6 is a fully customizable touchscreen remote for the HAL family. It supports multiple pages or tabs and any set of levels, toggles, selectors and/or commands. Drag, drop and resize controls any way that's desired. Use custom background images and logos in full-color on the 7-inch LCD display.

Screw the included wall-mount bracket over U.S. or international electrical boxes, or flush mount the 3/4" thick DR6 with a 2-inch hole in the wall to accommodate the cable. The optional DS1 desk stand accessory (shown) allows the DR6 to mount on a horizontal surface. The optional RB1 rack bracket installs the DR6 in a 19" equipment rack.

The included midspan power injector connects CAT5e (or better) cables between any HAL and the DR6 to deliver communications and the extra power needed for the display.

Optional, on-screen User Access logins secure management pages from public or staff use, and a programmable ambient light sensor automatically dims the backlight.

The Control Page Designer in Halogen 5.0 allows you to create one set of pages and use them in a web control design, DR6 display or both.

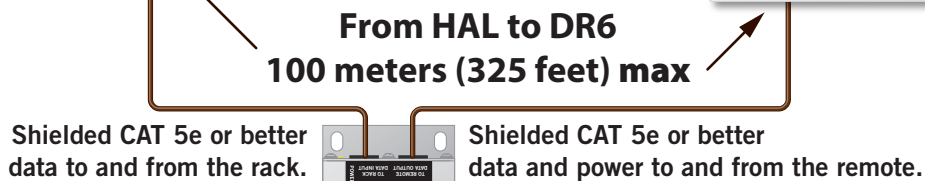
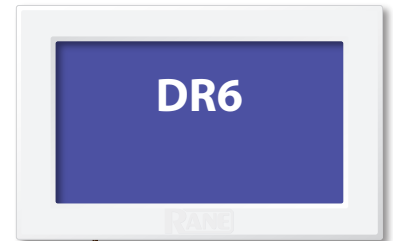
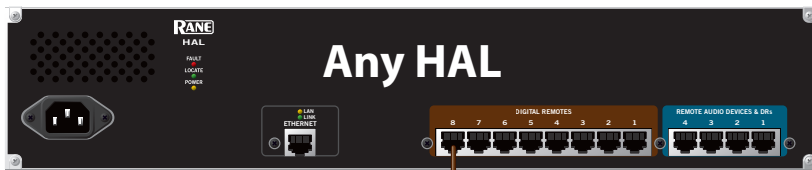

The RPI can go anywhere in between.

DS1 Desk Stand Accessory

- All steel, painted white.
- Rubber bottom protects the desktop.
- Kensington security hole.
- Holes in the bottom to fasten to a desktop.
- Larger hole in bottom to thread CAT 5 cable through the desktop.

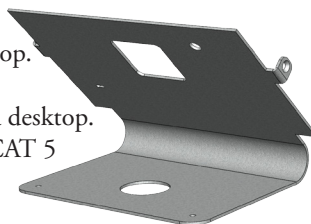

RB1 Rack Bracket Accessory

- All steel, painted black, 3U rack height.

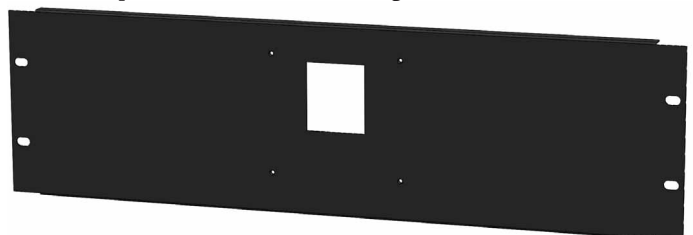

Halogen Web Controls

Control the Levels, Selectors, Toggles and Commands in any HAL System from **any device with a web browser**. Halogen's Web Controls feature allows creation of custom HTML GUI control screens. Define the quantity of control pages, and the layout, labeling and size of each control, and completely test them using your default web browser from within Halogen.

Access any control page from any browser-enabled device on the network with a HAL device. Just open a browser and type in the customizable IP/webpage address for the HTML page – and bookmark it for easy access. Type in an optional User Access code, and voilà, the trick, she is done! Control your HAL system wirelessly from one or more tablets, smart phones, laptops or desktop computers. The HAL web server is multi-client, allowing control across many devices and many rooms. You can link Rane's wired DR remote controls (DR1, DR2, DR3 & DR6) and wireless devices and they'll automatically track each other.

Customers are asking for "iPad control" and Halogen's Web Controls is the solution. It is not Apple®-centric — no iTunes® store or app installs required. We'll save a lot of ink on this page not listing all the possible devices that support web browsers and wireless Ethernet. Besides, the list will change before the ink dries.

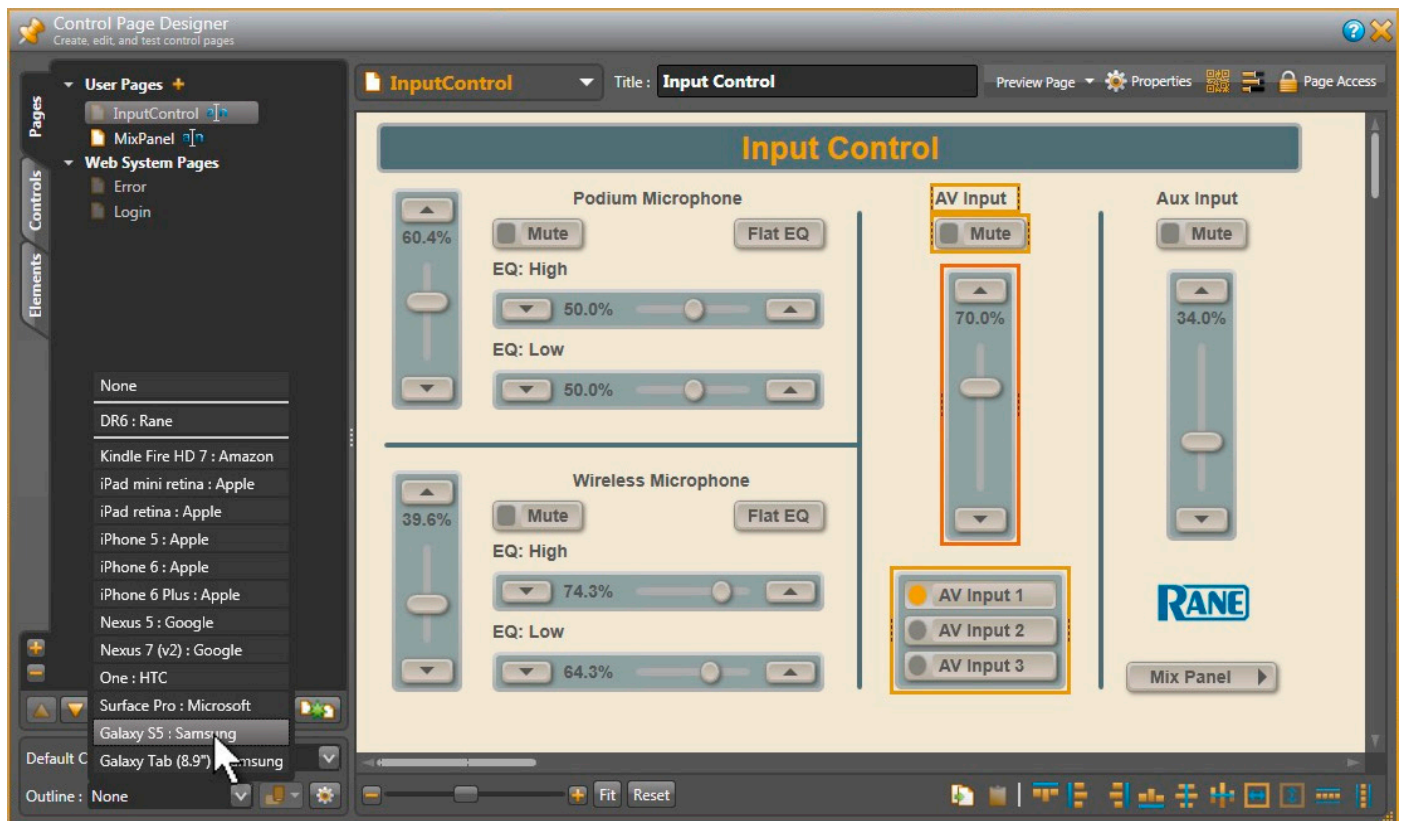
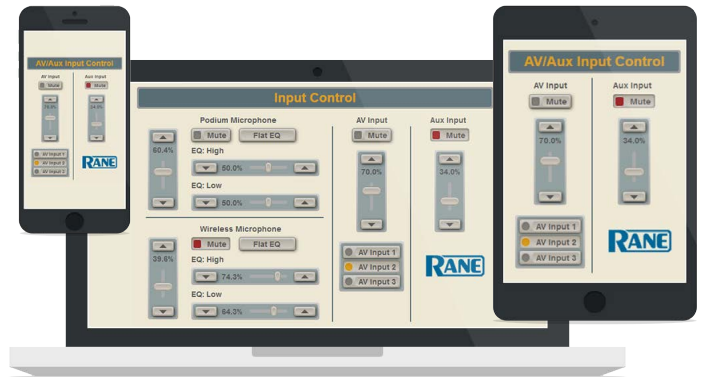
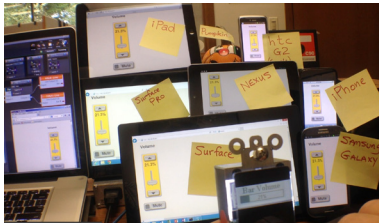

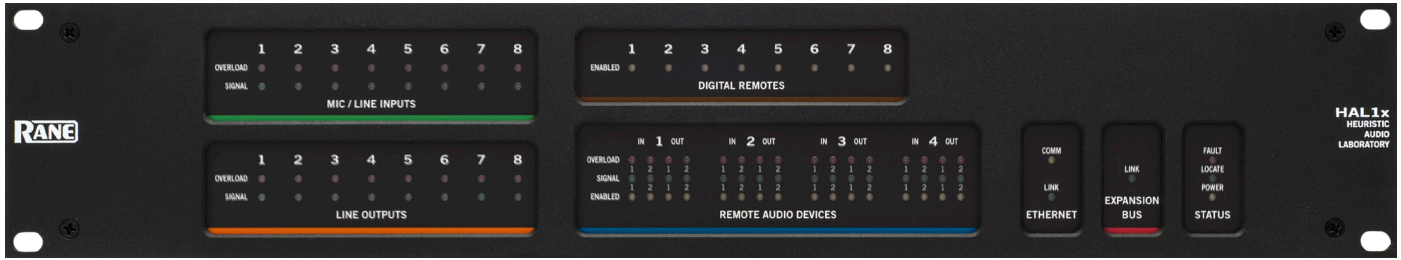

HAL1x Specifications

Parameter	Specification	Limit	Conditions/Comments
Analog I/O	8 x 8		
...Connectors	Euroblock		4 x 6-pin, 5 mm pitch, Green = Inputs, Orange = outputs
...CODEC	24-bit, 48 kHz		
Mic Inputs	Active Balanced		
...Gain Settings	+10 to +60 dB		1 dB steps
...Input Impedance	2.6 kΩ	1%	1 kHz, each leg to ground
...Phantom Power	+48 VDC		10 mA max per input
...Equivalent Input Noise	-127 dBu	max	20-20k Hz, 150 Ω source, 60 dB gain, A-weighted
...THD+N	< 0.008 %	typ	20-20k Hz, +4 dBu, +10 dB gain, 20 kHz BW
...Maximum Input	3 dBV (1.4 Vrms)	typ	Input gain at +10 dB, 1 kHz, < 1% THD+N
...CMRR	55 dB	min	1 kHz
Line Inputs	Active Balanced		
...Gain Settings	Unity & +10 to +20 dB		1 dB steps from +10 to +20
...Input Impedance	5.1 kΩ	1%	1 kHz, each leg to ground
...THD+N	< 0.008 %	typ	20-20k Hz, +4 dBu, unity gain, 20 kHz BW
...Maximum Input	20.8 dBu	typ	Input gain at 0 dB, 1 kHz, <1% THD+N
...Frequency Response	20-20k Hz, +0, -.05 dB		+4 dBu, unity gain
...Dynamic Range	109 dB	max	re +20 dBu, 20 kHz BW, A weighted, Rs = 150 Ω
...Interchannel Isolation	104 dB	max	20-20k Hz, +20 dBu, unity gain, channel-to-channel
...CMRR	45 dB	min	1 kHz
Outputs	Active Balanced		
...Impedance	200 Ω	1%	Each leg
...Maximum Output	+20.9 / +16.4 dBu	typ	1 kHz, 100 kΩ / 600 Ω load
...Frequency Response	20-20k Hz, +0.1 / -0.3 dB		+4 dBu, unity gain, 100 kΩ load
...Dynamic Range	109 dB	max	re +20 dBu, 20 kHz BW, A-weighted, 100 kΩ load
...Interchannel Isolation	110 dB	typ	20-20k Hz, +20 dBu, channel-to-channel, 100 kΩ load
Indicators			
...Signal	-50 dBFS	typ	Green LED, peak-reading
...Overload	-0.5 dBFS	typ	Red LED, peak-reading
Propagation Delays			See the graphic on page page 4.
...RAD In to RAD Out	1.71 ms	typ	Tested with RAD23
...RAD In to Analog Out	1.85 ms	typ	
...Analog In to RAD Out	2.25 ms	typ	
...Analog In to Analog Out	2.39 ms	typ	
DSP			
...HAL1x Processing Power	9600 MIPS	max	4 DSPs @ 300 MHz each with up to 8 instructions / cycle
...Word Length	32 / 64-bit Floating Point		
...HAL1x Delay Memory	80 seconds	max	

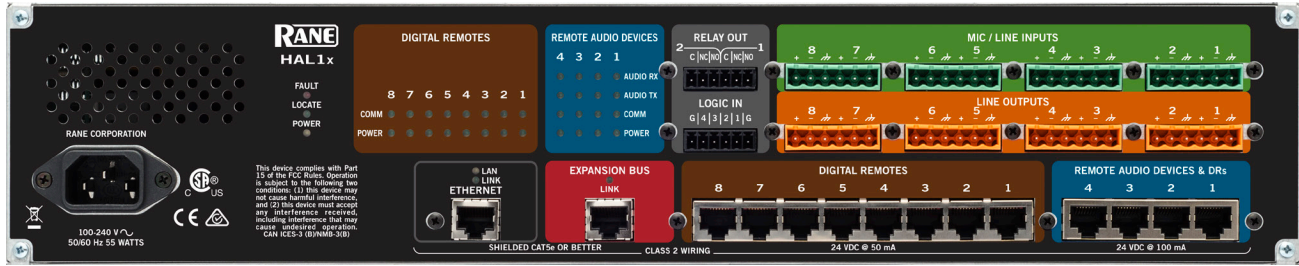

Parameter	Specification	Limit	Conditions/Comments
Computer Interface: Type	Ethernet 1000 base-T		Zeroconf service discovery protocol for easy set up
...Cable	Shielded CAT 5e or better		RJ-45 connector
...Length	100 meters / 300 feet	max	Standard Ethernet cable length limit
HAL1x Expansion Bus	Not on other HAL models		Shielded CAT 5e cable with RJ-45 connectors
...Audio Channels	512 in x 512 out of HAL1x	max	Plus control channel
...Maximum EXP Units	32	max	Daisy-chain
...Maximum Cable Length	100 meters / 300 feet	max	Per "hop." See "HAL1x Expansion Bus" on page 3.
...Propagation Delay "hop"	730 ns	typ	In and Out of Expansion Unit – 22.4 μ s across 32 EXPs.
RAD Ports	4		RJ-45 connectors
...Audio Channels	8 in x 8 out		Each port 2 in x 2 out, plus control channel, 24-bit, 48 kHz
...Power	24 VDC @ 100 mA	max	Each port
...Length	150 meters / 500 feet	max	Shielded CAT 5e cable or better
HAL1x DR Ports	8		RJ-45 connectors
...Power	24 VDC @ 50 mA	max	Each port
...Length	300 meters / 1000 feet	max	Shielded CAT 5e cable or better
Relay Outputs	2		
...Connector	Mini Euroblock		6-pin, 3.81 mm pitch, Black
...Type	COM, NC & NO		
...Limit	2 A, 48 V	max	60 W max switching power
Logic Inputs	4		
...Connector	Mini Euroblock		6-pin, 3.81 mm pitch, Black
...Type	Internal passive pull-up		Protected to +24 V
...Vin High	> 2.2 V	min	Normal state
...Vin Low	< 1.0 V	max	External circuit sinks > 22 μ A to assert
Wiring	Class 2		All rear panel terminals
Power Requirement	100 to 240 VAC		50/60 Hz, 50W max
Ambient Room Temp.	40 °C	max	Maximum external loading
Unit: Conformity	CE, FCC, cCSAus		
Unit: Size	2U, 3.5"H x 19"W x 8.25"D		(8.9 cm x 48.3 cm x 20.9 cm)
...Weight	7 lb		(3.2 kg)
Shipping: Size	6.5" x 20.3" x 13.75"		(11.5 cm x 52 cm x 35 cm)
...Weight	10 lb		(4.5 kg)

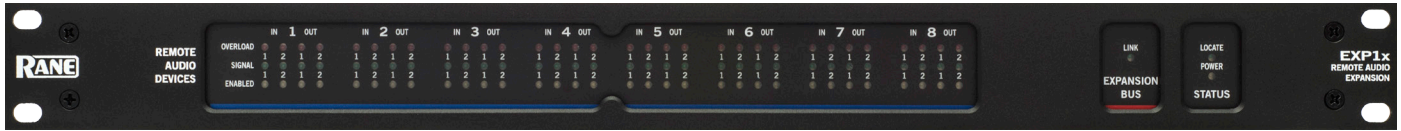

EXP1x Specifications

Parameter	Specification	Limit	Conditions/Comments
Expansion Bus	HAL1x is required		Shielded CAT 5e cable with RJ-45 connectors
...Audio Channels	512 in x 512 out of HAL1x	max	Plus control channel
...Maximum EXP1x Units	32	max	Daisy-chain with shielded CAT 5e or better
...Maximum Cable Length	100 meters / 300 feet	max	
RAD / DR Ports	8		RJ-45 connectors
...RAD Audio Channels	16 in x 16 out		Each port 2 in x 2 out, plus control channel, 24-bit, 48 kHz
...RAD Cable Length	150 meters / 500 feet	max	Shielded CAT 5e cable or better
...DR Cable Length	300 meters / 1000 feet	max	Shielded CAT 5e cable or better
...Power	24 VDC @ 100 mA	max	Each port
Wiring	Class 2		All rear panel terminals
Power Requirement	100 to 240 VAC		50/60 Hz, 35 W max
Unit: Conformity	CE, FCC, cCSAus		
Unit: Size	1U, 1.75" x 19" x 8.25"		(4.4 x 48.3 x 20.9 cm)
...Weight	4 lb 6 oz		(2.0 kg)
Shipping Size	6.5" x 20.3" x 13.75"		(11.5 x 52 x 35 cm)
...Weight	8 lb		(4.5 kg)



EXP2x Specifications

Parameter	Specification	Limit	Conditions/Comments
Expansion Bus	HAL1x is required		Shielded CAT 5e cable with RJ-45 connectors
...Audio Channels	512 in x 512 out of HAL1x	max	Plus control channel
...Maximum EXP2x Units	16 (all channels used)	max	Daisy-chain with shielded CAT 5e or better
...Maximum Cable Length	100 meters / 300 feet	max	
Dante Network			May use un shielded CAT 5e cable
...Sample Rates	44.1, 48, 88.2 or 96 kHz		Adjustable using Dante Controller
...TX Channels	32		At any supported sample rate, yes, even 96 kHz
...RX Channels	32		At any supported sample rate, yes, even 96 kHz
...Secondary Dante Port Modes	Switch or Redundant		
...Latency Support	250 μS, 500 μS, 1 mS, 2 mS, or 5 mS		Set in Dante controller
Wiring	Class 2		All rear panel terminals
Power Requirement	100 to 240 VAC		50/60 Hz, 12 W max
Unit: Conformity	CE, FCC, cCSAus		
Unit: Size	1U, 1.75" x 19" x 8.25"		(4.4 x 48.3 x 20.9 cm)
...Weight	4 lb 6 oz		(2.0 kg)
Shipping Size	6.5" x 20.3" x 13.75"		(11.5 x 52 x 35 cm)
...Weight	8 lb		(4.5 kg)



EXP3x Specifications

Parameter	Specification	Limit	Conditions/Comments
Expansion Bus	HAL1x is required		Shielded CAT 5e cable with RJ-45 connectors
...Audio Channels	512 in x 512 out of HAL1x	max	Plus control channel
...Maximum EXP3x Units	32	max	Daisy-chain with shielded CAT 5e or better
...Maximum Cable Length	100 meters / 300 feet	max	
Line Outputs	8 Balanced Outputs		Euroblock, 4 x 6-pin, 5 mm pitch, orange
...DAC	24-bit, 48 kHz		
...Maximum Output	+20 dBu / +16 dBu		10 kΩ / 600 Ω, 1 kHz
...Dynamic Range	107 dB	typ.	A-weighted
...Frequency Response	20 Hz to 20 kHz, +0.1 / -0.3 dB		+4 dBu, unity gain, 10 kΩ load
...Impedance	200 Ω / leg	typ.	@ 1 kHz
...Inter-channel Isolation	>100 dB	typ.	@ 1 kHz
...Signal Indicators	-50 dBFS	typ.	Green LED
...Overload Indicators	-0.5 dBFS	typ.	Red LED
Propagation Delays			
...Exp. Bus to Line Out	793 μs		
...RAD In to Exp Bus	466 μs		
...Exp. Bus to RAD Out	520 μs		
RAD / DR Ports	2 RAD / 6 DR		RJ-45 connectors
...RAD Audio Channels	4 in x 4 out		
...RAD Cable Length	150 meters / 500 feet		Shielded CAT 5e or better
...RAD Power	24 VDC @ 100 mA	max	Each Port
...DR Cable Length	300 meters / 1000 feet		Shielded CAT 5e or better
...DR Power	24 VDC @ 50 mA		
Logic Output Port			Mini Euroblock x 2, 6-pin, 3.81 mm pitch, black
...Internal Pull-up	1.0 kΩ, 5.0 V		Protected to +30 V, reverse polarity protected
...Sink Current	200 mA	max	Output FET on
...LED Drive Current	LED Drive Current 2 mA		Output FET off, Vf = 2.0 V
...Logic High Output Voltage	4.7 V	min	Output FET off, Output Current 0.0 mA
...Logic Low Output Voltage	0.1 V	max	Output FET on, Sink Current < 200 mA
Power Requirement	100 to 240 VAC		50/60 Hz, 25 W max
Unit: Conformity	CE, FCC, cCSAus		
Unit Size	1U, 1.75" x 19" x 8.25"		(4.4 x 48.3 x 20.9 cm)
...Weight	4 lb 10 oz		(2.1 kg)
Shipping Size	6.5" x 20.3" x 13.75"		(11.5 x 52 x 35 cm)
...Weight	8 lb		(4.5 kg)

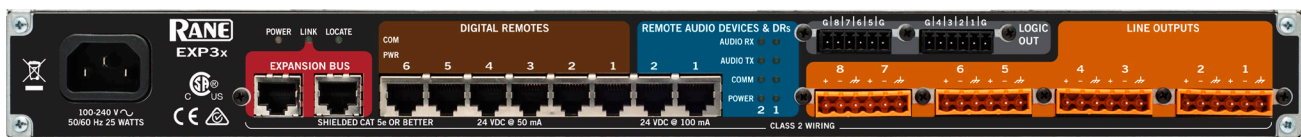



EXP5x Specifications

Parameter	Specification	Limit	Conditions/Comments
Expansion Bus	HAL1x is required		Shielded CAT 5e cable with RJ-45 connectors
...Audio Channels	512 in x 512 out of HAL1x	max	Plus control channel
...Maximum EXP5x Units	32	max	Daisy-chain with shielded CAT 5e or better
...Maximum Cable Length	100 meters / 300 feet	max	
Mic / Line / Line+ Inputs	12 Balanced Inputs		Euroblock, 4 x 6-pin, 5 mm pitch, green
...ADC	24-bit, 48 kHz		
...Line Input	4 Vrms / 12 dBV	min	1 kHz
...Line-Plus Input (L+R Mono)	4 Vrms / 12 dBV	min	1 kHz, Sum of Left and Right
...Condenser Mic Input	500 mVrms / -6 dBV	min	1 kHz, 48 V phantom power
...Dynamic Mic Input	127 mVrms / -18 dBV	min	1 kHz
...Dynamic Range	101 dB	typ.	A-weighted
...Frequency Response	20 Hz to 20 kHz, +0.1 / -0.3 dB		+4 dBu, unity gain, 10 kΩ load
...Input Impedance	5.766 kΩ / 2.9 kΩ	typ.	Balance / Each leg, @ 1 kHz
...Inter-channel Isolation	>100 dB	typ.	@ 1 kHz
...CMRR	55 dB	min	1 kHz
...Signal Indicators	-50 dBFS	typ.	Green LED
...Overload Indicators	-0.5 dBFS	typ.	Red LED
Propagation Delay	758 μs		Analog In to Exp Bus
DR Ports	2		RJ-45 connectors
...DR Cable Length	300 meters / 1000 feet		Shielded CAT 5e or better
...DR Power	24 VDC @ 50 mA		
Wiring	Class 2		
Ambient Room Temperature	45°C	max	
Power Requirement	100 to 240 VAC		50/60 Hz, 25 W max
Unit: Conformity	CE, FCC, cCSAus		
Unit Size	1U, 1.75" x 19" x 8.25"		(4.4 x 48.3 x 20.9 cm)
...Weight	4 lb 10 oz.		(2.1 kg)
Shipping Size	6.5" x 20.3" x 13.75"		(11.5 x 52 x 35 cm)
...Weight	8 lb		(4.5 kg)

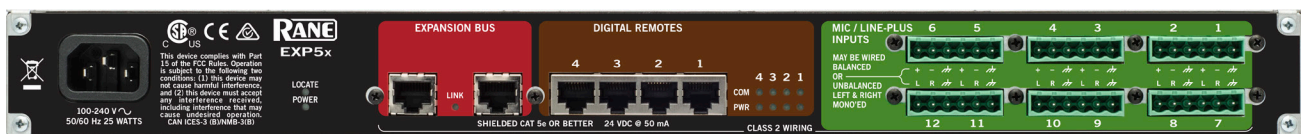



EXP7x Specifications

Parameter	Specification	Limit	Conditions/Comments
Expansion Bus	HAL1x is required		Shielded CAT 5e cable with RJ-45 connectors
...Audio Channels	512 in x 512 out of HAL1x	max	Plus control channel
...Maximum EXP7x Units	32	max	Daisy-chain with shielded CAT 5e or better
...Maximum Cable Length	100 meters / 300 feet	max	
AEC Processing	8 blocks		Add more EXP7x Expanders for up to 256 blocks
...Frequency Response	20 Hz to 20 kHz		
...Tail Length	300 ms		
...Propagation Delay	17 ms	max	
...Convergence Rate	100 dB per second		
Additional Processing			Included in each AEC block
...AGC			1 per AEC block
...Parametric Equalizer	5-band, + low- and high-cut		1 per AEC block
Wiring	Class 2		All rear panel terminals
Power Requirement	100 to 240 VAC		50/60 Hz, 15 W max
Unit Conformity	CE, FCC, cCSAus		
Unit Size	1U, 1.75" x 19" x 8.25"		(4.4 x 48.3 x 20.9 cm)
...Weight	4 lb 6 oz		(2.0 kg)
Shipping Size	6.5" x 20.3" x 13.75"		(11.5 x 52 x 35 cm)
...Weight	8 lb		(4.5 kg)



Ethernet, RAD and DR Cable Lengths

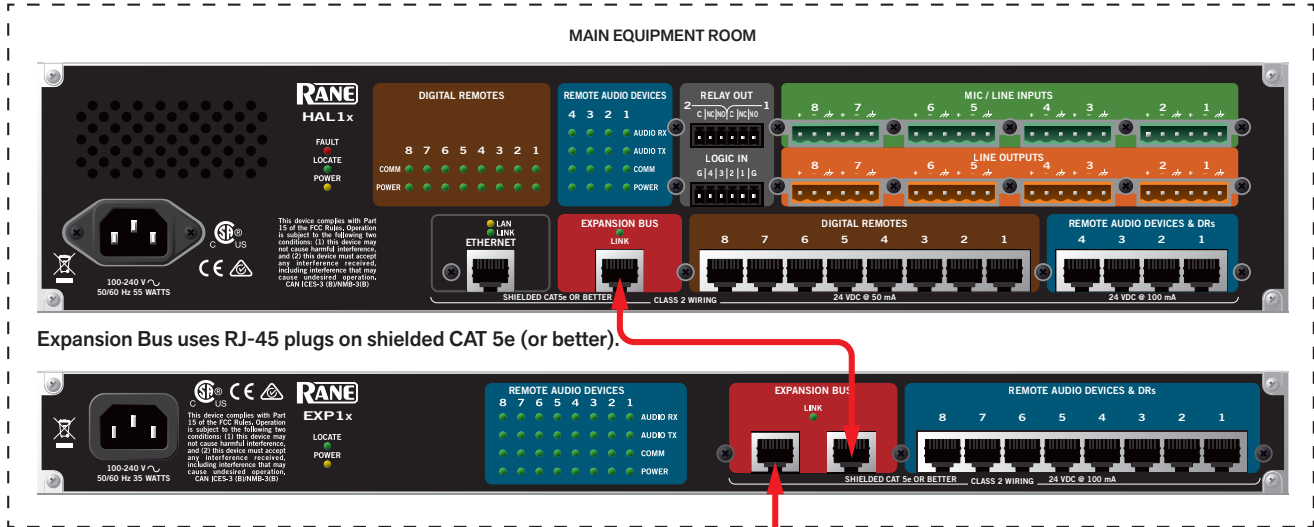
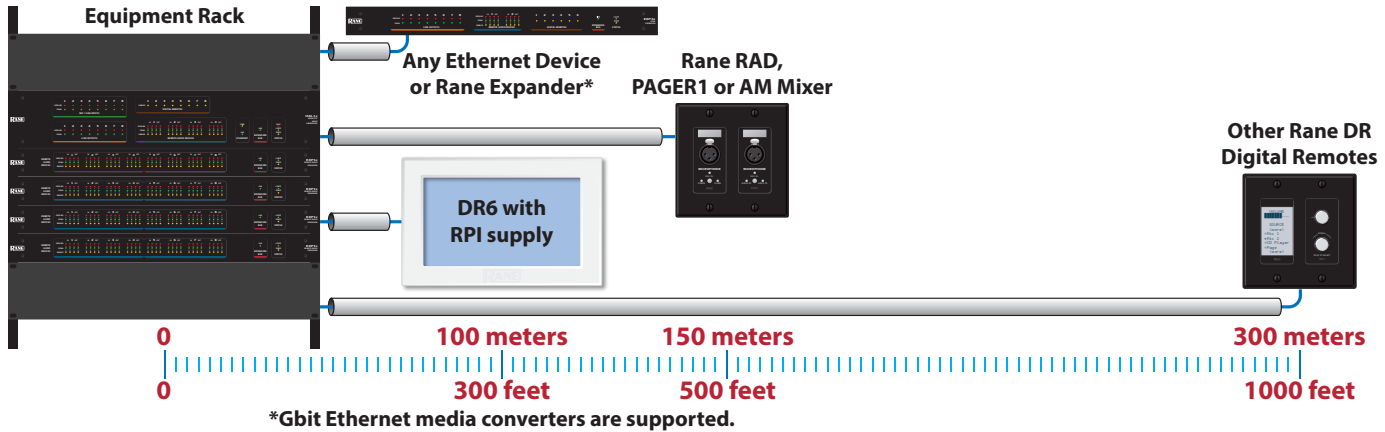

Expansion Bus uses RJ-45 plugs on shielded CAT 5e (or better).

Locate the Expanders up to 100 meters (300 feet) away from each other.
For greater distance, use off-the-shelf Gigabit media converters:

- Multimode Fiber: up to 2 km (1.2 miles)
- Singlemode Fiber: up to 12 km (7.5 miles)

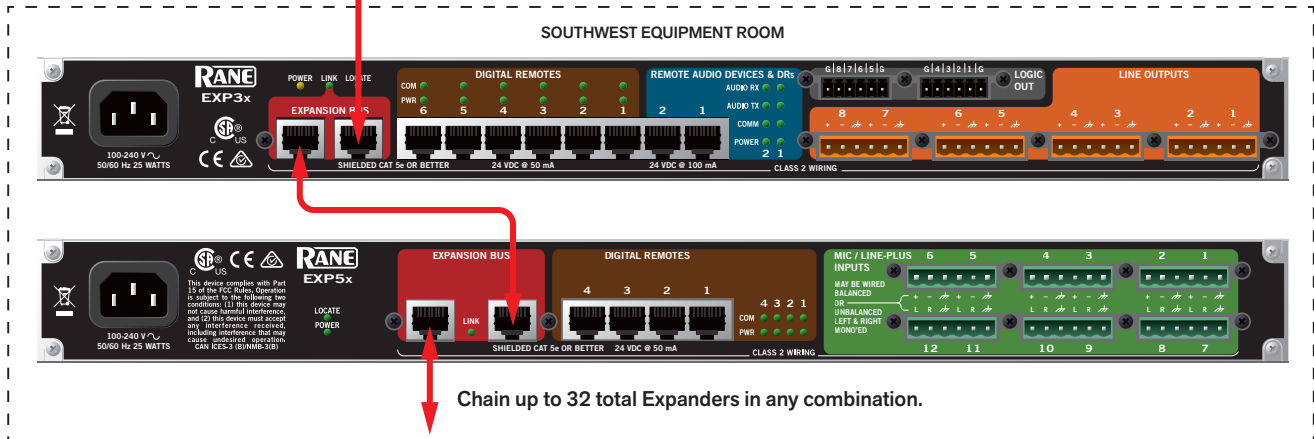
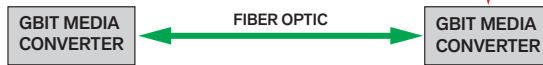

Chain up to 32 total Expanders in any combination.

Halogen Processing Blocks

in Halogen 5.0

Dynamics

Ambient Noise Compensator (ANC)
Automatic Gain Control (AGC)
Compressor
Ducker
Expander
Gate
Limiter

Misc. blocks

Level
Delay: simple
Delay: distance
Delay: video
Signal Meter
Pink Noise: Simple
Pink Noise: Ramped
Pink Noise: Swept
Sine Wave generator
Voice Detect

Filters

Feedback Suppressor
Cut Filter
Shelf Filter: single
Shelf Filter: multichannel
Parametric EQ: single
Parametric EQ: multichannel
Graphic EQ
FIR Filter
Crossover: 2-way mono
Crossover: 3-way mono
Crossover: 4-way mono
Crossover: 2-way stereo
Crossover: 3-way stereo
Crossover: 4-way stereo
Crossover: all-pass
Crossover: CD horn

Mixers

Mixer: 2 to 80 inputs
Matrix Mixer
Gain-sharing Auto Mixer
Gain-sharing Auto Matrix Mixer

Selectors

Selector: 2 to 80 inputs
Priority Selector
Router: 2 to 80 outputs

Conferencing

(requires EXP7x)
Acoustic Echo Canceling (AEC)
Conference Switchboard
Conference Room Combine
Compressor: Tracking
ANC: Tracking

Paging and Room Combine

Distributed Program Bus
Paging Station with 2-band PEQ, Compressor, Level
Paging Zone
Emergency Page Zone
Zone Processor with Priority Selector, Level, Paging Zone

The Room Combine block contains processors in this order:

- Gain-sharing Auto Mixer for a Mic Input.
- Mixer for a Line input.
- Sum for the Mic and Line Inputs.
- Selector from the Distributed Program Bus.
- Level control.
- Paging Zone.

HAL1x Multiprocessor Architects & Engineers Specification

The digital multiprocessor shall be a 16 in x 16 out configuration having sixteen inputs: eight balanced analog on plug-in barrier strips that can be either mic- or line-level with switchable +48 V phantom power, and four digital remote audio device ports providing up to two digital inputs and two digital outputs per port, as well as eight balanced analog line-level outputs on plug-in barrier strips. Provisions shall be provided for eight digital remotes to control source or preset selection, toggle and/or level control, control logic expansion and wall sensors, located up to 300 meters (1,000 feet) away. **The digital remote shall connect to and be powered by the rack room multiprocessor using a dedicated homerun over shielded CAT 5e (or better) cable. Low communication data rates shall permit use of punch-down blocks or RJ-45 patch bays for homerun cable routing flexibility as well as relaxed minimum bend radius.** In addition there shall be four contact closure logic inputs on a plug-in barrier strip and two separate relay Form C contact outputs. The multiprocessor shall be expandable using a 512 x 512 channel serial expansion bus interface via RJ-45 connectors, which shall connect up to 32 optional, daisy-chained expander units. The remote audio devices shall provide A/D and/or D/A conversion based on AES3 transport to the wall up to 150 meters (500 feet) from the multiprocessor, as well as units for cascading automatic microphone mixing up to 64 channels, ambient sensing mics, and advanced paging stations. All remote audio devices and digital remotes shall connect via shielded CAT 5e (or better) cable to the multiprocessor. Further, all remote audio devices and digital remote devices shall support portable use and hot-swapping so that devices may be replaced without shutting down the system, and do so without any audio interference, and that all settings for new devices are automatically downloaded from the multiprocessor along with the correct firmware. The unit shall connect to a computer using a standard Ethernet connector. All functions shall be designed, configured and controlled by a software program featuring a graphical user interface that allows managing the global tasks of discovering, connecting to, and applying configurations to the digital multiprocessor. The hardware-software combination shall automatically check and display the status, location, CAT 5e crimp and wiring integrity, and that audio is flowing to and/or from all peripheral devices. The hardware multiprocessor and the software shall each include Ethernet ASCII text over TCP/IP control support for third-party control systems such as AMX, Crestron and Stardraw Control, and capable of creating controls for use in a web browser. The processor shall have an internal 100-240 VAC, 50/60 Hz power supply.

The digital multiprocessor shall be a Rane HAL1x running Rane Halogen software, and using Rane Remote Audio Devices (RADs), and Rane Digital Remotes (DRs).

EXP1x Expander Architects & Engineers Specification

The Expander shall add 16 digital audio inputs and 16 digital audio outputs to the digital multiprocessor via provisions for eight remote audio device ports. The remote audio devices shall provide A/D and/or D/A conversion based on AES3 transport to the wall up to 150 meters (500 feet) from the multiprocessor, as well as units for cascading automatic microphone mixing up to 64 channels, ambient sensing mics, small amplifiers, and advanced paging stations. The eight remote audio device ports shall also support digital remotes to control source or preset selection, toggle and/or level control, control logic expansion and wall sensors, located up to 300 meters (1,000 feet) away. All remote audio devices and digital remotes shall connect via shielded CAT 5e (or better) cable to the multiprocessor. Further, all remote audio devices and digital remote devices shall support portable use and hot swapping so that devices may be replaced without shutting down the system, and do so without any audio interference, and that all settings for new devices are automatically downloaded from the multiprocessor along with the correct firmware. The Expander shall connect to the multiprocessor via a standard RJ-45 connector and cable, with the capability to daisy chain a maximum of 32 expanders to the multiprocessor for a total of 512 inputs and 512 outputs. The processor shall have an internal 100-240 VAC, 50/60 Hz power supply.

The Expander shall be a Rane EXP1x with Rane Remote Audio Devices (RADs).

Trademarks

• Heuristic Audio Laboratory (HAL)[®] • HAL and Halogen are trademarks of Rane Corporation • AMX[®] and the AMX logo are registered trademarks of AMX • Stardraw Control is a trademark of Stardraw.com Ltd. • Crestron[®] is a registered trademark of Crestron Electronics, Inc. • Decora[®] is a registered trademark of Leviton • Dante is a trademark of Audinate Pty Ltd, Audinate is a registered trademark of Audinate Pty Ltd. • Windows[®] is a registered trademark of Microsoft Corporation in the United States and other countries. • Apple, Mac, Macintosh, iTunes, Safari, QuickTime, GarageBand, and OS X are registered trademarks of Apple Inc., registered in the U.S. and other countries.