

BOSE[®]



SP-24

ControlSpace[®]

Sound Processor

Installation and Operating Guide

Installations- og betjeningsvejledning

Installatie- en bedieningshandleiding

Guide d'installation et d'utilisation

Installations- und Bedienungsanleitung

Manuale di installazione e funzionamento

Guía de instalación y funcionamiento

Bruksanvisning för installation och användning

Safety Information4

Introduction20

 Key Features20

 ControlSpace SP-24 Editor software.....20

 Additional Documentation20

Quick Start21

Product Overview22

 In the Box.....22

 Front Panel Controls and Indicators22

 Rear Panel Connections22

Hardware Installation.....23

 Rack Mounting the Chassis23

 Spacing.....23

Connections23

 Audio Connections23

 Power Connection23

 Balanced and Unbalanced Connections24

 USB Connection24

 System Requirements24

Front Panel Setup and Configuration25

 Front Panel User Interface26

 Front Panel Menu Structure Control Map.....26

 Preset Modes27

 Fixed Input and Output Routing Tables27

 Loading Presets.....27

 Custom Scenes27

 Utility Menu.....27

 Saving Settings.....27

 Maximum Input Level28

 Input Gain28

 Delay28

 Output Gain28

 User Lockout28

 Factory Reset29

 Updating Firmware and Loudspeaker EQ Presets29

 SP-24 Editor PC Application29

 Features and Capabilities29

 Software Download and User’s Guide29

Sample Output Configurations.....30

Troubleshooting.....34

Appendix36

 Technical Specifications36

 Mechanical Diagrams37

 Utility Menu Ranges.....37

 Routing Categories for Preset Modes37

 Additional Resources38

Safety Information

Please read this installation and operating guide. Please take the time to follow the instructions in this installation and operating guide carefully. It will help you set up and operate your system properly and enjoy all of its advanced features. Please save this installation and operating guide for future reference.

 **WARNING:** To reduce the risk of fire or electrical shock, do not expose the product to rain or moisture.

 **WARNING:** Do not expose this apparatus to dripping or splashing, and do not place objects filled with liquids such as vases, on or near the apparatus. As with any electronic products, use care not to spill liquids into any part of the system. Liquids can cause a failure and/or a fire hazard.

 **WARNING:** Do not place any naked flame sources, such as lighted candles, on or near the apparatus.

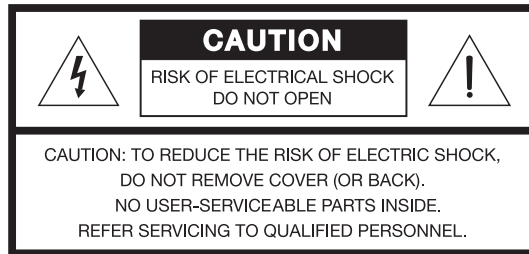



 The lightning flash with arrowhead symbol, within an equilateral triangle, is intended to alert the user to the presence of uninsulated dangerous voltage within the system enclosure that may be of sufficient magnitude to constitute a risk of electrical shock.

 The exclamation point within an equilateral triangle, as marked on the system, is intended to alert the user to the presence of important operating and maintenance instructions in this installation and operating guide.

 **CAUTION:** This product shall be connected to an AC mains socket outlet with a protective earthing (grounding) connection.

 **CAUTION:** Make no modifications to the amplifier or accessories. Unauthorized alternations may compromise safety, regulatory compliance, and system performance.

 **CAUTION:** Where the mains plug or appliance coupler is used as the disconnect device, such disconnect device shall remain readily operable.

 This product conforms to all applicable EU directive requirements. The complete Declaration of Conformity can be found at www.Bose.com/compliance.

Note: Where the mains plug or appliance coupler is used as the disconnect device, such disconnect device shall remain readily operable.

Note: Provide an earth connection before the main plug is connected to the mains.

Note: The product must be used indoors. It is neither designed nor tested for use outdoors, in recreation vehicles, or on boats.

Note: When mounting adjacent to heat-generating products such as power amplifiers, allow a 1RU open space between the SP-24 sound processor and the amplifier to allow for air flow.

Important Safety Instructions

1. Read these instructions.
2. Keep these instructions.
3. Heed all warnings.
4. Follow all instructions.
5. Do not use this apparatus near water.
6. Clean only with a dry cloth.
7. Do not block any ventilation openings. Install in accordance with the manufacturer's instructions. To ensure reliable operation of the product and to protect it from overheating, put the product in a position and location that will not interfere with its proper ventilation.
8. Do not install near any heat sources, such as radiators, heat registers, stoves, or other apparatus (including amplifiers) that produce heat.
9. Do not defeat the safety purpose of the polarized or grounding-type plug. A polarized plug has two blades with one wider than the other. A grounding-type plug has two blades and a third grounding prong. The wider blade or third prong is provided for your safety. If the provided plug does not fit in your outlet, consult an electrician for replacement of the obsolete outlet.

10. Protect the power cord from being walked on or pinched, particularly at plugs, convenience receptacles, and the point where they exit from the apparatus.
11. Only use attachments/accessories specified by the manufacturer.
12. Use only with the cart, stand, tripod, bracket, or table specified by the manufacturer or sold with the apparatus. When a cart is used, use caution when moving the cart/apparatus combination to avoid injury from tip-over. 
13. Unplug this apparatus during lightning storms or when unused for long periods of time.
14. Refer all servicing to qualified service personnel. Servicing is required when the apparatus has been damaged in any way such as power-supply cord or plug is damaged; liquid has been spilled or objects have fallen into the apparatus; the apparatus has been exposed to rain or moisture, does not operate normally, or has been dropped.

Information About Products That Generate Electrical Noise (FCC Compliance Notice for U.S.)

This equipment has been tested and found to comply with the limits for a Class A digital device, pursuant to part 15 of the FCC Rules. These limits are designed to provide reasonable protection against harmful interference when the equipment is operated in a commercial environment. This equipment generates, uses, and can radiate radio frequency energy and, if not installed and used in accordance with the instruction manual, may cause harmful interference to radio communications. Operation of this equipment in a residential area is likely to cause harmful interference in which case the user will be required to correct the interference at their own expense.

Changes or modifications not expressly approved by Bose Corporation could void the user's authority to operate this equipment.

This Class A digital apparatus complies with Canadian ICES-003.

This product meets all EN55103-2 immunity requirements for E2 electromagnetic environment.

Sikkerhedsinformation

Læs venligst denne installations- og betjeningsvejledning. Tag dig tid til at følge instruktionerne i denne installations- og betjeningsvejledning omhyggeligt. Den vil hjælpe dig til at installere og betjene systemet korrekt, så du kan drage nytte af alle dets avancerede funktioner. Opbevar venligst denne installation- og betjeningsvejledning, så du har den til rådighed senere.



ADVARSEL: Produktet må ikke udsættes for regn eller fugtighed på grund af risikoen for brand eller elektrisk stød.



ADVARSEL: Udsæt ikke dette apparat for dryp eller stænk, og placer ikke genstande, der er fyldt med væske, på eller nær ved apparatet. Som ved alle elektriske apparater skal du passe på ikke at spilde væske på nogen af systemdelene. Væsker kan forårsage fejl i systemet og/eller medføre fare for brand.



ADVARSEL: Placer ikke nogen form for åben ild (f.eks. stearinlys) på eller tæt ved apparatet.



Symbolet med et lyn med pilespids i en ligesidet trekant skal gøre brugeren opmærksom på tilstedeværelsen af en uisoleret farlig spænding i det lukkede system, der kan være tilstrækkelig kraftig til at give elektrisk stød.



En ligebenet trekant med et udråbstegn, som markeret på systemet, skal henlede brugerens opmærksomhed på vigtige betjenings- og vedligeholdelsesinstruktioner i denne installations- og betjeningsvejledning.



FORSIGTIG: Dette produkt skal tilsluttes en stikkontakt med en beskyttende jordforbindelse.



FORSIGTIG: Undlad at foretage ændringer af forstærkeren eller tilbehøret. Uautoriserede ændringer kan have negativ indvirkning på sikkerheden, overholdelse af lovbestemmelser og systemets ydeevne.



FORSIGTIG: Hvis lysnetstikket eller apparatets kobler anvendes som afbryder, skal denne afbryder være let at komme til.



Dette produkt lever op til alle relevante krav i EU-direktiverne. Den fulde overensstemmelseserklæring finder du på www.Bose.com/compliance.

Bemærk: Hvis lysnetstikket eller apparatets kobler anvendes som afbryder, skal denne afbryder være let at komme til.

Bemærk: Sørg for at etablere en jordforbindelse, før netstikket tilsluttes en stikkontakt.

Bemærk: Produktet skal anvendes inden døre. Det er hverken designet eller testet til udendørs brug, brug i fritidskøretøjer eller i både.

Bemærk: Hvis du monterer ved siden af apparater, der genererer varme, som f.eks. strømforstærkere, skal du sørge for et åbent område på 1RU mellem SP-24-lydprocessoren og forstærkeren for at muliggøre luftgennemstrømningen.

Vigtige sikkerhedsinstruktioner

1. Læs disse instruktioner.
2. Gem disse instruktioner.
3. Ret dig efter alle advarsler.
4. Følg alle instruktioner.
5. Anvend ikke dette apparat i nærheden af vand.
6. Rengør kun med en tør klud.
7. Undgå at blokere ventilationsåbningerne. Installer i overensstemmelse med producentens instruktioner. For at sikre pålidelig funktion og beskytte mod overophedning skal produktet anbringes i en position og på et sted, der ikke hindrer korrekt ventilation.
8. Installer ikke produktet i nærheden af varmekilder som f.eks. radiatorer, varmeovne, komfurer eller andre apparater (herunder forstærkere), der producerer varme.
9. Omgå ikke sikkerheden ved brug af et ikke-jordforbundet stik. Et polariseret stik har to stikben, hvor det ene er bredere end det andet. Et jordforbundet stik har to ben og et tredje jordben. Det brede ben eller tredje ben er der for din sikkerhed. Hvis det medfølgende stik ikke passer i stikkontakten, skal du kontakte en elektriker for at få stikkontakten udskiftet.
10. Beskyt netledningen mod at blive trådt på eller klemt, især ved stikkene, stikkontakter og på det sted, hvor den kommer ud af apparatet.
11. Brug kun tilslutningsudstyr/tilbehør, der er angivet af producenten.

12. Brug kun apparatet sammen med en vogn, et stativ, et beslag eller et bord, der er angivet af producenten eller solgt sammen med apparatet.
Når der anvendes en vogn, skal der udvises forsigtighed ved kørsel med vogn/apparat, så det ikke vælter.
13. Afbryd strømmen til apparatet under tordenvejr, eller når det står ubrugt i lang tid.
14. Overlad al servicering til kvalificeret servicepersonale. Et serviceeftersyn er påkrævet, når apparatet på nogen måde er beskadiget, hvis f.eks. netledningen eller stikket er beskadiget, der er blevet spildt væske, eller der er kommet genstande ind i apparatet, hvis apparatet er blevet udsat for regn eller fugt, ikke virker normalt eller er blevet tabt.



Oplysninger om produkter, der genererer elektrisk støj (meddelelse om FCC-overensstemmelse for USA).

Dette udstyr er blevet testet og overholder grænserne for en digital enhed i klasse A i henhold til del 15 af FCC-reglerne. Disse grænser er udviklet til at yde rimelig beskyttelse mod skadelig interferens, når udstyret anvendes i en professionel installation. Dette udstyr genererer, bruger og kan udstråle radiofrekvensenergi, og kan – hvis det ikke installeres og bruges i overensstemmelse med brugervejledningen – forårsage skadelig interferens i forbindelse med radiokommunikation. Brug af dette udstyr i en privat installation kan forårsage skadelig interferens, og i så fald må brugeren få udbedret interferensen for egen regning.

Ændringer eller modifikationer, der ikke udtrykkeligt er godkendt af Bose Corporation, kan ophæve brugerens ret til at betjene dette udstyr.

Dette produkt overholder den canadiske ICES-003 Klasse A-specifikation.

Dette produkt overholder alle EN55103-2 immunitetskrav for et E2 elektromagnetisk miljø.

Veiligheidsinformatie

Lees deze installatie- en bedieningshandleiding door. Neem de tijd om de instructies in deze installatie- en bedieningshandleiding zorgvuldig te volgen. De instructies dienen om uw systeem juist te configureren en te bedienen en alle geavanceerde functies optimaal te benutten. Bewaar deze installatie- en bedieningshandleiding voor later gebruik.



WAARSCHUWING: Om het risico van brand of elektrische schokken te verlagen, mag dit product niet worden blootgesteld aan regen of vocht.



WAARSCHUWING: Dit apparaat mag niet worden blootgesteld aan druipende of spattende vloeistoffen, en er mogen geen met vloeistoffen gevulde voorwerpen, zoals vazen, op of bij het apparaat worden geplaatst. Evenals bij andere elektronische producten dient u op te letten dat er geen vloeistof in enig deel van het systeem terecht komt. Vloeistoffen kunnen leiden tot storing en/of brandgevaar.



WAARSCHUWING: Er mogen geen open vlammen, zoals brandende kaarsen, op of bij het apparaat worden geplaatst.



Het symbool met bliksemschicht en pijl in een gelijkzijdige driehoek is bedoeld om de gebruiker te waarschuwen voor de aanwezigheid van gevaarlijke niet-geïsoleerde spanning in het systeem die hoog genoeg kan zijn om een risico van elektrische schokken te vormen.



Het uitroepteken in de driehoek dat is afgebeeld op het systeem maakt de gebruiker attent op belangrijke bedienings- en onderhoudsinstructies in deze installatie- en bedieningshandleiding.



OPGELET: Dit product moet worden aangesloten op een geaard stopcontact.



OPGELET: Breng geen wijzigingen aan aan de versterker of de accessoires. Wijzigingen door onbevoegden kunnen de veiligheid, de naleving van wetten en voorschriften en de werking van het systeem in gevaar brengen.



OPGELET: Wanneer de netstekker of connector als stroomonderbreker wordt gebruikt, dient deze stroomonderbreker steeds goed bereikbaar te zijn.



Dit product voldoet aan alle vereisten van de van toepassing zijnde EU-richtlijnen. De volledige conformiteitsverklaring kunt u vinden op www.Bose.com/compliance.

Opmerking: Wanneer de netstekker of connector als stroomonderbreker wordt gebruikt, dient deze stroomonderbreker steeds goed bereikbaar te zijn.

Opmerking: Zorg voor aarding voordat u de netstekker op het stopcontact aansluit.

Opmerking: Het product moet binnenshuis worden gebruikt. Het is niet ontworpen of getest voor gebruik buitenshuis, in recreatievoertuigen of op boten.

Opmerking: Bij installatie in de buurt van producten die warmte produceren, zoals versterkers, dient u te zorgen dat er een ruimte van 1 U (44,45 mm) is tussen de SP-24-geluidsprocessor en de versterker, om luchtstroming mogelijk te maken.

Belangrijke veiligheidsinstructies

1. Lees deze instructies door.
2. Bewaar deze instructies.
3. Neem alle waarschuwingen in acht.
4. Volg alle instructies.
5. Gebruik dit apparaat niet in de buurt van water.
6. Alleen reinigen met een droge doek.
7. De ventilatieopeningen niet blokkeren. Installeer het apparaat volgens de instructies van de fabrikant. Om een betrouwbare werking van het product te garanderen en dit tegen oververhitting te beschermen, plaatst u het product in een positie en op een plaats waar de ventilatie niet wordt geblokkeerd.

8. Niet installeren in de buurt van warmtebronnen, zoals radiatoren, kachelroosters, fornuizen of andere apparaten (waaronder versterkers) die warmte produceren.
9. Schakel de veiligheidsfunctie van de gepolariseerde of gearde stekker niet uit. Een gepolariseerde stekker heeft twee platte pinnen, waarbij de ene breder is dan de andere. Een aardstekker heeft twee platte pinnen en een derde, ronde pin voor de aarding. De brede platte pin of de derde, ronde pin is aangebracht voor uw veiligheid. Als de stekker niet in het stopcontact past, dient u contact op te nemen met een elektricien om het verouderde stopcontact te vervangen.
10. Zorg dat er niet op het netsnoer wordt gestaan of gelopen en dat het niet wordt afgekneld, met name bij de stekkers en stopcontacten en het punt waar deze uit het apparaat komen.
11. Gebruik uitsluitend randapparatuur/accessoires die worden gespecificeerd door de fabrikant.
12. Uitsluitend gebruiken in combinatie met het verrijdbare plateau, het statief, de drievoetbeugel of de tafel die door de fabrikant worden gespecificeerd of bij het apparaat worden verkocht. Als u een verrijdbaar plateau gebruikt, moet u het apparaat en het plateau voorzichtig verplaatsen zodat deze niet omvallen en letsel veroorzaken.
13. Verwijder de stekker van dit apparaat uit het stopcontact bij onweer of als het langere tijd niet wordt gebruikt.
14. Laat alle onderhoud over aan bevoegd onderhoudspersoneel. Onderhoud is vereist als het apparaat is beschadigd. Dit is bijvoorbeeld het geval als het netsnoer of de stekker is beschadigd, als er vloeistof is gemorst of voorwerpen in het apparaat zijn gevallen, als het apparaat is blootgesteld aan regen of vocht, niet normaal werkt of is gevallen.



Informatie over producten die elektrische ruis genereren (FCC Compliance Notice voor de VS)

Dit apparaat is getest en voldoet aan de limieten voor een digitaal apparaat van de klasse A, volgens deel 15 van de FCC-voorschriften. Deze limieten zijn bedoeld om redelijke bescherming te bieden tegen schadelijke storing bij installatie in een handelsomgeving. Dit apparaat genereert en gebruikt radiofrequente energie en kan deze uitstralen en het kan, als het niet wordt geïnstalleerd en gebruikt volgens de instructies, schadelijke storing veroorzaken aan radiocommunicatie. Gebruik van dit apparaat in een woonwijk kan schadelijke storing veroorzaken. In dit geval moet de gebruiker de storing op eigen kosten verhelpen.

Veranderingen of aanpassingen die niet uitdrukkelijk zijn goedgekeurd door Bose Corporation kunnen leiden tot het vervallen van de bevoegdheid van de gebruiker om dit apparaat te gebruiken.

Dit digitale apparaat van klasse A voldoet aan de Canadese ICES-003.

Dit product voldoet aan alle EN55103-2-immuniteitsvereisten voor een E2 elektromagnetische omgeving.

Informations relatives à la sécurité

Veillez lire cette notice d'installation et d'utilisation Prenez le temps de lire attentivement les instructions de cette notice d'installation et d'utilisation. Elles vous seront précieuses pour installer et utiliser correctement votre système et vous aideront à tirer le meilleur parti de sa technologie. Conservez cette notice d'installation et d'utilisation pour référence ultérieure.



AVERTISSEMENT : pour limiter les risques d'incendie ou d'électrocution, n'exposez pas l'appareil à la pluie ou à l'humidité.



AVERTISSEMENT : protégez l'appareil de tout risque de ruissellement ou d'éclaboussure. Ne placez pas d'objets contenant des liquides, tels que des vases, sur l'appareil. Comme avec tout appareil électronique, veillez à ne pas renverser de liquides sur une partie quelconque de l'appareil. Les liquides peuvent provoquer des pannes et/ou un risque d'incendie.



AVERTISSEMENT : ne placez aucune source de flamme nue, comme une bougie allumée, sur ou près de l'appareil.

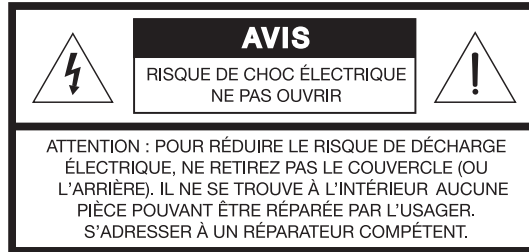

Le symbole représentant un éclair avec une flèche à l'intérieur d'un triangle équilatéral est utilisé pour prévenir l'utilisateur de la présence d'une tension électrique dangereuse non isolée à l'intérieur de l'appareil. Cette tension est d'un niveau suffisamment élevé pour représenter un risque d'électrocution.



Le symbole représentant un point d'exclamation à l'intérieur d'un triangle équilatéral, tel qu'il figure sur le système, signale à l'utilisateur la présence d'instructions importantes relatives au fonctionnement et à l'entretien de l'appareil dans cette notice d'installation et d'utilisation.



ATTENTION : cet appareil doit être raccordé à une prise secteur dotée d'une mise à la terre.



ATTENTION : n'apportez aucune modification à l'amplificateur ou aux accessoires. Toute modification non autorisée peut compromettre votre sécurité, le respect des réglementations et les performances.



ATTENTION : lorsque la fiche d'alimentation ou la prise multiple est utilisée comme dispositif de débranchement de l'appareil, elle doit rester facilement accessible.



Ce produit est conforme à toutes les directives de la Communauté Européenne qui s'y appliquent. L'attestation complète de conformité est disponible à l'adresse www.Bose.com/compliance.

Remarque : lorsque la fiche d'alimentation ou la prise multiple est utilisée comme dispositif de débranchement de l'appareil, elle doit rester facilement accessible.

Remarque : avant de brancher l'appareil à une prise électrique, vérifiez que celle-ci est bien raccordée à la terre.

Remarque : ce produit doit être utilisé en intérieur. Il n'a pas été conçu ni testé pour une utilisation en extérieur, dans des véhicules ou sur des bateaux.

Remarque : en cas de montage à proximité d'un appareil générant de la chaleur tel qu'un amplificateur de puissance, préservez un espace libre de 1 rack de hauteur entre le processeur audio SP-24 et l'amplificateur pour permettre l'évacuation de la chaleur.

Instructions importantes relatives à la sécurité

1. Veuillez lire ces instructions.
2. Veuillez conserver ces instructions.
3. Respectez tous les avertissements.
4. Suivez toutes les instructions.
5. N'utilisez pas cet appareil à proximité d'eau ou d'une source d'humidité.
6. Utilisez uniquement un chiffon sec pour le nettoyage.
7. Ne bloquez jamais les orifices d'aération. Suivez les instructions du fabricant pour l'installation. Pour garantir un fonctionnement fiable du produit et le protéger contre tout risque de surchauffe, installez-le à un emplacement et dans une position permettant d'assurer une ventilation correcte.
8. N'installez pas cet appareil à proximité d'une quelconque source de chaleur, telle qu'un radiateur, une arrivée d'air chaud, un four ou tout autre appareil (notamment les amplificateurs) produisant de la chaleur.

9. Veillez à profiter de la sécurité offerte par les fiches de type terre ou polarisées. Les fiches polarisées sont équipées de deux bornes de largeurs différentes. Les fiches de type terre sont équipées de deux bornes et d'un orifice pour la mise à la terre. Ces deux types de dispositifs ont pour but d'assurer votre sécurité. Si la prise fournie ne s'adapte pas à votre prise de courant, consultez un électricien pour qu'il remplace cette prise obsolète.
10. Protégez le cordon d'alimentation contre les risques de piétinement ou de pincement, notamment au niveau des fiches, des prises de courant et des branchements à l'appareil.
11. Utilisez uniquement les accessoires spécifiés par le fabricant.
12. Utilisez uniquement le chariot, le support, le trépied, l'équerre ou la table spécifié(e) par le fabricant ou vendu(e) avec l'appareil. Si vous utilisez un chariot, faites attention à ne pas faire basculer l'ensemble chariot/appareil. 
13. Débranchez cet appareil pendant les orages ou au cours des longues périodes de non utilisation.
14. Confiez toute réparation à du personnel qualifié. Une réparation est nécessaire lorsque l'appareil a été endommagé de quelque façon que ce soit (endommagement du cordon d'alimentation ou de la fiche électrique, renversement d'un liquide ou de tout objet sur l'appareil, exposition de l'appareil à la pluie ou à l'humidité, mauvais fonctionnement, chute de l'appareil, etc.).

Informations sur les produits générateurs de bruit électrique (Notice de conformité FCC pour les USA)

Ce matériel a fait l'objet de tests prouvant sa conformité aux limites imposées aux appareils numériques de classe A, conformément à la partie 15 des réglementations de la FCC. Ces limites sont conçues pour offrir une protection raisonnable contre les interférences nuisibles lorsque l'appareil est utilisé en environnement commercial. Cet appareil génère, utilise et est susceptible d'émettre de l'énergie à certaines fréquences radio. À ce titre, s'il n'est pas installé ou utilisé conformément aux instructions, il est susceptible de perturber les communications radio. L'utilisation de cet équipement dans une zone résidentielle risque de provoquer des interférences nuisibles, auquel cas l'utilisateur devra remédier au problème à ses propres frais.

Toute modification non autorisée expressément par Bose Corporation est susceptible d'annuler le droit de l'utilisateur à mettre en œuvre celui-ci.

Ce produit de classe A est conforme aux spécifications de la réglementation ICES-003 du Canada.

Ce produit répond aux critères d'immunité des directives EN55103-2 pour les appareils de classe E2.

Sicherheitshinweise

Bitte lesen Sie diese Installations- und Bedienungsanleitung durch. Beachten Sie sorgfältig die Hinweise in dieser Installations- und Bedienungsanleitung. Diese Anleitung unterstützt Sie bei der Einrichtung und beim ordnungsgemäßen Betrieb des Geräts und seiner modernen Funktionen. Bitte bewahren Sie diese Installations- und Bedienungsanleitung zum späteren Nachschlagen auf.



WARNUNG: Um Brände und Stromschläge zu vermeiden, darf dieses Produkt weder Regen noch Feuchtigkeit ausgesetzt werden.



WARNUNG: Schützen Sie das Gerät vor tropfenden oder spritzenden Flüssigkeiten, und stellen Sie keine mit Flüssigkeiten gefüllten Gefäße (z. B. Vasen) auf das Gerät oder in die Nähe des Geräts. Wie bei allen elektronischen Geräten dürfen niemals Flüssigkeiten ins Innere gelangen. Dadurch kann es zu Fehlfunktionen oder Bränden kommen.



WARNUNG: Stellen Sie keine brennenden Kerzen oder ähnliches auf das Gerät oder in die Nähe des Geräts.

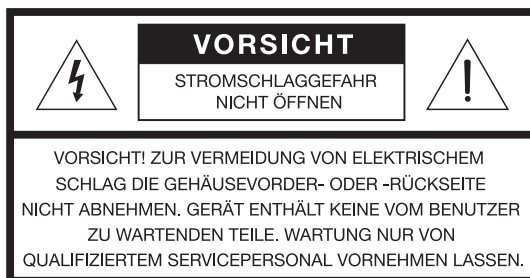

Das Blitzsymbol mit Pfeilspitze in einem gleichseitigen Dreieck weist den Benutzer auf das Vorhandensein einer nicht isolierten gefährlichen elektrischen Spannung innerhalb des Systemgehäuses hin, durch die die Gefahr von Stromschlägen besteht.



Das Ausrufezeichen in einem gleichseitigen Dreieck, wie es am System angebracht ist, soll den Benutzer auf wichtige Bedienungs- und Wartungsanweisungen in dieser Installationsanleitung aufmerksam machen.



ACHTUNG: Dieses Produkt muss an eine Steckdose mit Erdungsschutz angeschlossen werden.



ACHTUNG: Nehmen Sie keine Veränderungen am Verstärker oder am Zubehör vor. Nicht autorisierte Veränderungen können die Sicherheit, die Erfüllung von Richtlinien und die Systemleistung beeinträchtigen.



ACHTUNG: Falls Sie den Netzstecker oder eine Mehrfachsteckdose verwenden, um das Gerät von der Stromversorgung zu trennen, sollten Sie sicherstellen, dass Sie jederzeit auf den Stecker zugreifen können.



Dieses Produkt entspricht allen Anforderungen der geltenden EU-Richtlinien. Die vollständige Konformitätserklärung ist einsehbar unter www.Bose.com/compliance.

Hinweis: Falls Sie den Netzstecker oder eine Mehrfachsteckdose verwenden, um das Gerät von der Stromversorgung zu trennen, sollten Sie sicherstellen, dass Sie jederzeit auf den Stecker zugreifen können.

Hinweis: Stellen Sie eine Erdung her, bevor Sie den Netzstecker an eine Steckdose anschließen:

Hinweis: Das Produkt ist nicht für den Einsatz im Freien geeignet. Verwenden Sie es nur innerhalb von Gebäuden und nicht in Campingfahrzeugen, auf Booten oder in ähnlichen Umgebungen

Hinweis: Lassen Sie bei der Montage neben wärmeerzeugenden Produkten wie Verstärkern 1RU freien Platz zwischen dem SP-24 Sound Processor und dem Verstärker, um eine Luftströmung zu ermöglichen.

Wichtige Sicherheitshinweise

1. Lesen Sie die folgenden Anweisungen.
2. Bewahren Sie die Anweisungen auf.
3. Beachten Sie alle Warn- und Sicherheitshinweise.
4. Befolgen Sie alle Anweisungen.
5. Verwenden Sie dieses Gerät nicht in der Nähe von Wasser.
6. Reinigen Sie das Gerät nur mit einem sauberen, trockenen Tuch.
7. Achten Sie darauf, dass die Lüftungsöffnungen nicht blockiert sind. Stellen Sie das Gerät nur in Übereinstimmung mit den Herstelleranweisungen auf – Stellen Sie es nur an einem Ort auf, an dem eine gute Belüftung gewährleistet ist, um den zuverlässigen Betrieb des Geräts sicherzustellen und es vor Überhitzung zu schützen.
8. Stellen Sie das Gerät nicht in der Nähe von Wärmequellen auf, wie Heizkörpern, Wärmespeichern, Öfen oder anderen Geräten (auch Verstärkern), die Wärme erzeugen.

9. Beeinträchtigen Sie in keiner Weise die Schutzfunktion des Schutzkontaktsteckers. Ein gepolter Stecker hat zwei Stromkontakte, von denen einer breiter als der andere ist. Ein Schutzkontaktstecker hat zwei Stromkontakte und einen dritten Erdungskontakt. Der dritte Kontakt dient der Sicherheit. Falls der mitgelieferte Stecker nicht in Ihre Steckdose passt, wenden Sie sich an einen qualifizierten Elektriker, um die Steckdose auszutauschen.
10. Verlegen Sie das Netzkabel so, dass es keine Stolpergefahr darstellt und nicht beschädigt werden kann – insbesondere im Bereich von Steckern und Steckdosen und dort, wo das Netzkabel aus dem Gerät herausgeführt wird.
11. Verwenden Sie nur Zubehör-/Anbauteile, die vom Hersteller zugelassen sind.
12. Verwenden Sie für das Gerät nur Rollwagen, Ständer, Dreibeine, Halterungen oder Tische, die vom Hersteller zugelassen sind oder zusammen mit dem Gerät verkauft werden. Falls Sie einen Rollwagen verwenden, dürfen Sie die Einheit Gerät/Rollwagen nur mit Vorsicht bewegen, damit Verletzungen beim möglichen Umkippen ausgeschlossen sind. 
13. Ziehen Sie das Netzkabel bei Gewitter oder bei längerer Nichtbenutzung des Gerätes aus der Steckdose.
14. Wenden Sie sich bei allen Reparatur- und Wartungsarbeiten nur an qualifiziertes Kundendienstpersonal. Wartungsarbeiten sind in folgenden Fällen nötig: Bei jeglichen Beschädigungen wie z. B. des Netzkabels oder Netzsteckers, wenn Flüssigkeiten oder Gegenstände in das Gehäuse gelangt sind, das Gerät Regen oder Feuchtigkeit ausgesetzt wurde, fallen gelassen wurde oder nicht ordnungsgemäß funktioniert.

Informationen über Produkte, die elektrisches Rauschen verursachen (Hinweis zur FCC-Einhaltung für die USA.)

Dieses Gerät wurde geprüft. Es stimmt mit den Regelungen für Geräte der Klasse A gemäß Teil 15 der FCC-Vorschriften überein. Diese Grenzwerte sollen einen angemessenen Schutz gegen elektromagnetische Störungen beim Betrieb in gewerblicher Umgebung gewährleisten. Dieses Gerät erzeugt und verwendet Hochfrequenzstrahlung und kann sie auch aussenden. Daher verursacht das Gerät, wenn die Installation und Benutzung nicht in Übereinstimmung mit dieser Bedienungsanleitung erfolgt, möglicherweise Störungen des Funkverkehrs. Beim Betrieb dieses Geräts in Wohngebieten können erhebliche Störungen des Funkverkehrs verursacht werden. Eventuell daraus entstehende Kosten trägt allein der Benutzer des Geräts.

Veränderungen am Gerät, die nicht durch die Bose Corporation autorisiert wurden, können zur Folge haben, dass die Betriebserlaubnis für das Gerät erlischt.

Dieses digitale Gerät der Klasse A entspricht den Anforderungen der kanadischen Richtlinie CES-003.

Dieses Produkt erfüllt alle Immunitätsanforderungen gemäß EN55103-2 für elektromagnetische E2-Umgebungen.

Informazioni sulla sicurezza

Leggere attentamente questa guida all'installazione e all'uso. Seguire scrupolosamente le istruzioni riportate in questa guida all'installazione e all'uso del prodotto, che consentono di configurare e utilizzare correttamente il sistema e sfruttarne appieno le funzionalità avanzate. Conservare questa guida per farvi riferimento in futuro.



AVVERTENZA: per ridurre il rischio di incendio o scosse elettriche, non esporre il prodotto a pioggia o umidità.



AVVERTENZA: non esporre l'apparecchio a gocce o schizzi e non porre oggetti colmi di liquidi, quali vasi, sopra o accanto all'apparecchio. Come per qualsiasi prodotto elettronico, è importante che all'interno delle parti del sistema non penetrino liquidi in quanto potrebbero causare guasti e/o rischio di incendio.



AVVERTENZA: non collocare sorgenti di fiamme libere (ad esempio candele accese) sull'apparecchio o nelle sue vicinanze.



Il simbolo del lampo con freccia racchiuso in un triangolo equilatero indica all'utilizzatore che all'interno dell'involucro è presente una tensione non isolata di entità tale da rappresentare un potenziale pericolo di scarica elettrica.



Il simbolo del punto esclamativo racchiuso all'interno di un triangolo equilatero, che appare sul sistema, rimanda l'utente alla lettura di istruzioni d'uso e manutenzione importanti contenute in questa guida all'installazione e all'uso.



ATTENZIONE: questo prodotto deve essere collegato a una presa di corrente alternata dotata di un impianto protettivo di messa a terra.



ATTENZIONE: non apportare modifiche al sistema o agli accessori, in quanto le modifiche non autorizzate possono compromettere la sicurezza, la conformità alle norme e le prestazioni del sistema.



ATTENZIONE: la spina dell'alimentazione o dell'accoppiatore deve essere raggiungibile facilmente e rapidamente se è utilizzata come dispositivo di spegnimento.



Questo prodotto è conforme a tutti i requisiti pertinenti delle direttive UE. La dichiarazione di conformità completa è disponibile all'indirizzo www.Bose.com/compliance.

Nota: la spina dell'alimentazione o dell'accoppiatore deve essere raggiungibile facilmente e rapidamente se è utilizzata come dispositivo di spegnimento.

Nota: prima di collegare la spina dell'alimentazione alla presa di corrente, dotare la presa di impianto di messa a terra.

Nota: il prodotto è destinato all'uso in ambienti interni. Non è stato progettato né collaudato per l'uso in ambienti esterni, camper o imbarcazioni.

Nota: quando l'apparecchio viene montato accanto a prodotti che generano calore, ad esempio degli amplificatori di potenza, mantenere uno spazio libero pari a 1 RU (unità rack) tra il processore sonoro e l'amplificatore per consentire un adeguato passaggio di aria.

Informazioni importanti sulla sicurezza

1. Leggere queste istruzioni.
2. Conservare queste istruzioni.
3. Prestare attenzione a tutte le avvertenze.
4. Seguire tutte le istruzioni.
5. Non utilizzare l'apparecchio in prossimità di acqua.
6. Utilizzare solo un panno asciutto per la pulizia.
7. Non ostruire le aperture di ventilazione. Installare il prodotto in conformità con le istruzioni fornite dal produttore. Per assicurare un funzionamento ottimale del prodotto e impedirne il surriscaldamento, collocarlo in una posizione e in un luogo tali da non impedire la corretta ventilazione.
8. Non installare i diffusori in prossimità di fonti di calore quali termosifoni, radiatori, stufe o altre apparecchiature (compresi gli amplificatori) che generano calore.

9. Non escludere l'obiettivo di sicurezza della spina polarizzata o con messa a terra. Una spina polarizzata è dotata di due poli, uno più largo dell'altro. Una spina con messa a terra è dotata di due poli e di un terzo terminale di massa. Il polo più largo e il terzo terminale sono presenti per sicurezza. Se la spina in dotazione non è adatta alla presa, rivolgersi a un elettricista per la sostituzione della presa obsoleta.
10. Fare in modo che il cavo di alimentazione non venga calpestato o schiacciato, soprattutto in corrispondenza di spine, prese e nel punto di uscita dall'apparato.
11. Utilizzare solo sistemi di aggancio/accessori specificati dal produttore.
12. Utilizzare solo carrelli, supporti, treppiedi, staffe o tavoli specificati dal produttore o venduti insieme all'apparato. Quando si utilizza un carrello, prestare attenzione durante lo spostamento dell'insieme carrello/apparato per evitare di rovesciarlo causando danni.
13. Scollegare l'apparato durante i temporali o quando rimane inutilizzato a lungo.
14. Affidarsi a personale qualificato per tutti gli interventi di assistenza. Gli interventi di assistenza si rendono necessari quando l'apparato ha subito danni di qualsiasi tipo, ad esempio se il cavo di alimentazione o la spina sono danneggiati, se è stato versato del liquido o sono caduti oggetti sull'apparato, se l'apparato è stato esposto a pioggia o umidità, se non funziona normalmente o è caduto.



Informazioni sui prodotti che generano interferenze elettriche (avviso di conformità FCC per gli Stati Uniti)

Questa apparecchiatura è stata sottoposta a collaudo ed è risultata conforme ai limiti relativi ai dispositivi digitali di Classe A previsti dalla Parte 15 delle norme FCC. Tali limiti sono stati fissati allo scopo di assicurare un'adeguata protezione dalle interferenze dannose quando l'apparecchiatura è utilizzata in un'installazione commerciale. Questa apparecchiatura genera, utilizza e può irradiare energia a radiofrequenza e, se non installata e utilizzata in conformità con il manuale di istruzioni, può interferire negativamente con le comunicazioni radiofoniche. L'utilizzo di questa apparecchiatura in un'area residenziale può provocare interferenze dannose, nel qual caso l'utente dovrà adottare misure correttive a proprie spese.

Eventuali modifiche o alterazioni non espressamente approvate da Bose Corporation possono rendere nulla l'autorizzazione dell'utente all'utilizzo dell'apparecchiatura stessa.

Il presente apparato digitale di Classe B è conforme alla normativa Canadian ICES-003.

Il presente prodotto è conforme a tutti i requisiti di immunità EN55103-2 per ambienti elettromagnetici di tipo E2.

Información de seguridad

Lea esta guía de instalación y del usuario. Dedique el tiempo que sea necesario para seguir atentamente las instrucciones de esta guía de instalación y del usuario. Le ayudará a instalar y utilizar correctamente el sistema y a disfrutar de todas sus funciones avanzadas. Guarde esta guía de instalación y del usuario para consultarla en el futuro.



ADVERTENCIA: Para reducir el riesgo de incendio o descarga eléctrica, no exponga el producto a lluvia o humedad.



ADVERTENCIA: No exponga este aparato a salpicaduras o goteo. No coloque encima o cerca del aparato objetos que contengan líquidos, como jarrones. Al igual que con cualquier producto electrónico, evite que se derramen líquidos en los componentes del sistema, ya que pueden provocar averías o riesgo de incendio.



ADVERTENCIA: No coloque sobre el aparato o cerca de éste llamas vivas, como por ejemplo, velas.



El símbolo de relámpago con una flecha dentro de un triángulo equilátero indica al usuario que la caja del sistema puede contener una tensión sin aislar de magnitud suficiente para constituir un riesgo de descarga eléctrica.



El signo de exclamación dentro de un triángulo equilátero, tal como aparece marcado en el sistema, avisa al usuario de que existen instrucciones de operación y mantenimiento importantes en esta guía de instalación y del usuario.



PRECAUCIÓN: Este producto se debe conectar a una toma de la red eléctrica con una conexión de tierra que sirva de protección.



PRECAUCIÓN: No realice modificaciones en el amplificador o los accesorios. Las alteraciones no autorizadas pueden comprometer aspectos de seguridad, cumplimiento normativo y rendimiento del sistema.



PRECAUCIÓN: Si se utiliza el enchufe de red o el conector del aparato como dispositivo de desconexión, deberá poder accionarse fácilmente.



Este producto cumple todos los requisitos aplicables de las Directivas de la UE. Encontrará la declaración de conformidad completa en www.Bose.com/compliance.

Nota: Si se utiliza el enchufe de red o el conector del aparato como dispositivo de desconexión, deberá poder accionarse fácilmente.

Nota: Establezca una conexión de tierra antes de conectar el enchufe a la red eléctrica.

Nota: Este producto debe utilizarse en interiores. No está diseñado ni se ha probado para uso al aire libre, en vehículos de recreo o embarcaciones.

Nota: Si lo monta junto a productos generadores de calor, como amplificadores de potencia, deje un espacio abierto de 1RU entre el procesador de sonido SP-24 y el amplificador para permitir la circulación del aire.

Instrucciones de seguridad importantes

1. Lea las siguientes instrucciones.
2. Guarde estas instrucciones.
3. Tenga presentes todas las advertencias.
4. Siga todas las instrucciones.
5. No utilice este aparato cerca del agua.
6. Límpielo solo con un trapo seco.
7. No bloquee las aberturas de ventilación. Instálelo siguiendo las instrucciones del fabricante. Para garantizar un funcionamiento fiable del producto y evitar que se recaliente, colóquelo en una ubicación y posición que permitan una ventilación adecuada.
8. No lo instale cerca de fuentes de calor, tales como radiadores, salidas de aire caliente, cocinas u otros aparatos (incluidos amplificadores) que generen calor.

9. No elimine el mecanismo de seguridad del enchufe con toma a tierra o polarizado. Los enchufes polarizados disponen de dos clavijas, una de mayor tamaño que la otra. Los enchufes con toma a tierra tienen dos clavijas y un tercer terminal de tierra. La patilla más ancha y el tercer terminal se incluyen como medida de seguridad. Si el enchufe suministrado no encaja en la toma, póngase en contacto con un electricista para sustituir la toma antigua.
10. Proteja el cable de alimentación de forma que nadie lo pise ni quede pinzado, en particular cerca de enchufes, receptáculos de tomas múltiples y en el lugar en que sale del aparato.
11. Utilice sólo conexiones y accesorios suministrados por el fabricante.
12. Utilícelo sólo con el carrito, soporte, trípode, abrazadera o mesa suministrados por el fabricante o incluidos con el dispositivo. Cuando utilice un carrito, tenga cuidado al mover el carrito con el dispositivo para evitar que caiga y produzca daños.
13. Desenchufe el aparato si se produce una tormenta eléctrica o si no lo va a utilizar durante periodos prolongados de tiempo.
14. Toda reparación debe ser realizada por personal cualificado. Lleve el dispositivo a reparar si presenta algún daño como, por ejemplo, si el cable de alimentación o el enchufe están dañados, si se han vertido líquidos o se han caído objetos sobre el dispositivo o si éste ha estado expuesto a la lluvia o humedad; si no funciona correctamente o se ha caído al suelo.

**Información sobre productos que generan ruido eléctrico (Nota de homologación FCC para EE UU)**

Se ha comprobado que este equipo cumple los límites para dispositivos digitales de clase A, de acuerdo con el apartado 15 de las normas de la FCC. Estos límites están diseñados para ofrecer una protección razonable contra las interferencias perjudiciales cuando el aparato se utiliza en un entorno comercial. Este equipo genera, utiliza y puede irradiar energía de radiofrecuencia y, si no se instala y se utiliza de acuerdo con el manual de instrucciones, podría ocasionar interferencias perjudiciales para las comunicaciones por radio. La utilización de este equipo en una zona residencial podría causar interferencias dañinas. En ese caso, la corrección de la interferencia correrá a cargo del usuario.

Los cambios o modificaciones no aprobados expresamente por Bose Corporation podrían anular la autorización que tiene el usuario para utilizar este equipo.

Este aparato de Clase A cumple la especificación canadiense ICES-003.

Este producto cumple todos los requisitos de inmunidad EN55103-2 para entornos electromagnéticos E2.

Säkerhetsinformation

Läs igenom dessa installations- och säkerhetsanvisningar. Följ dessa installations- och säkerhetsanvisningar. Detta hjälper dig att installera och använda systemet på rätt sätt och att få glädje av alla avancerade funktioner. Spara dessa installations- och säkerhetsanvisningar eftersom de kan vara bra att ha till hands i framtiden.

 **Varning!** Minska risken för brand eller elektriska stötar genom att inte utsätta produkten för regn eller fukt.

 **Varning!** Utsätt inte produkten för vätska och placera inga föremål som exempelvis vaser fyllda med vätska på systemet eller i dess närhet. Precis som med andra elektroniska produkter bör du vara försiktig så att du inte spiller vätska i någon del av systemet. Vätskor kan orsaka fel och/eller brand.

 **Varning!** Tända ljus eller andra föremål med öppna lågor får inte placeras på eller i närheten av produkten.

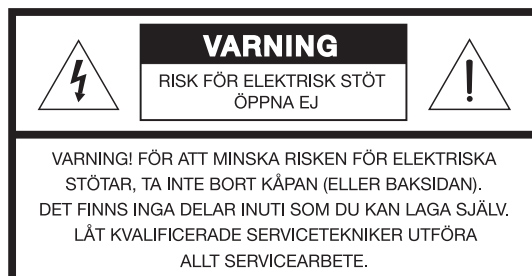

 Symbolen med en pilförsedd blixtnuti en liksidig triangel är avsedd att varna användaren för oisolerad, farlig spänning inuti produkten. Denna spänning kan vara kraftig nog att ge elektriska stötar.

 Utropstecknet i en triangel, som finns på systemet, vill uppmärksamma användaren på att det finns viktiga användnings- och underhållsanvisningar i den här bruksanvisningen.

 **FÖRSIKTIGHET!** Den här produkten ska anslutas till ett skyddsjordat eluttag.

 **FÖRSIKTIGHET!** Ändra inte systemet eller tillbehören på något sätt. Otillåtna ändringar kan äventyra säkerheten, efterlevandet av bestämmelser samt systemets prestanda.

 **FÖRSIKTIGHET!** Om produkten kopplas bort från strömförsörjningen med elsladden eller kontakten ska dessa vara lättåtkomliga.

 Den här produkten uppfyller bestämmelserna i alla tillämpliga EU-direktiv. En komplett försäkran om överensstämmelse finns på www.Bose.com/compliance.

Obs! Om produkten kopplas bort från strömförsörjningen med elsladden eller kontakten ska dessa vara lättåtkomliga.

Obs! Se till att det finns en jordanslutning innan du sätter i nätkabelns kontakt i ett eluttag.

Obs! Produkten får bara användas inomhus. Den har inte konstruerats eller testats för utomhusbruk eller för användning på båtar eller i husvagnar/husbilar.

Obs! Vid montering i närheten av värmegenererande produkter, som exempelvis förstärkare, ska du lämna ett avstånd på ca 5 cm mellan SP-24-ljudförstärkaren och förstärkaren för att tillåta luftväxling.

Viktiga säkerhetsanvisningar

1. Läs de här anvisningarna.
2. Behåll anvisningarna.
3. Ge akt på alla varningar.
4. Följ alla anvisningar.
5. Använd inte produkten i närheten av vatten.
6. Rengör endast med en torr trasa.
7. Blockera inte ventilationsöppningarna. Installera produkten i enlighet med tillverkarens anvisningar. För att produkten ska fungera tillförlitligt och skyddas mot överhettning ska den placeras i ett sådant läge och på en sådan plats att tillräcklig luftväxling kan ske.
8. Installera inte produkten nära någon värmekälla (som t.ex. element, värmespjäll och spisar) eller någon annan produkt (inklusive förstärkare) som avger värme.
9. Åsidosätt inte säkerhetsfunktionen i en polariserad eller jordad kontakt. En polariserad kontakt har två flata stift, det ena bredare än det andra. En jordad kontakt har två stift och ett tredje jordat stift. Det breda stiftet och jordstiftet finns där för att öka din säkerhet. Om den medföljande kontakten inte passar i ditt eluttag ska du be en elektriker att byta ut det föråldrade uttaget.

10. Skydda elkabeln så att ingen trampar på den och så att den inte kommer i kläm. Detta är särskilt viktigt vid kontakterna, tillbehörsuttagen och den plats där elsladden kommer ut ur produkten.
11. Använd bara den utrustning/de tillbehör som rekommenderas av tillverkaren.
12. Använd endast produkten tillsammans med vagnen, stället, stativet, fästet eller bordet som rekommenderas av tillverkaren eller säljs tillsammans med produkten. Om en vagn används ska du vara försiktig när du flyttar vagnen med produkten så att den inte välter och orsakar skada.
13. Koppla bort produkten från eluttaget när åskan går eller om den inte ska användas under en längre period.
14. Låt utbildad servicepersonal utföra all service. Service krävs om produkten har skadats på något vis, till exempel om nätkabeln eller kontakten har skadats, om vätska har spillts ut på eller föremål har ramlat ner i produkten, om produkten har utsatts för regn eller fukt, om den inte fungerar som den ska eller om du har tappat den.



Information om produkter som genererar elektriskt brus (Meddelande angående FCC-överensstämmelse för USA.)

Den här utrustningen har testats och befunnits överensstämma med gränsvärdena för digitala enheter av klass A, i enlighet med del 15 i FCC:s bestämmelser. Gränsvärdena är avsedda att ge ett rimligt skydd mot skadliga störningar när utrustningen används i en kommersiell miljö. Den här utrustningen genererar, använder och kan avge radiofrekvensenergi, och om utrustningen inte installeras och används i enlighet med anvisningarna kan den orsaka skadliga störningar i samband med radiokommunikation. Användning av denna utrustning i bostäder kan orsaka störningar som användaren är skyldig att korrigera på egen bekostnad.

Om utrustningen ändras eller modifieras på något sätt som inte uttryckligen har godkänts av Bose Corporation, kan det innebära att användarens rätt att använda produkten upphävs.

Denna klass A-produkt uppfyller villkoren enligt ICES-003-villkoren i Kanada.

Denna produkt uppfyller alla villkor enligt EN55103-2 för klassen E2 i elektromagnetiska miljöer.

Introduction

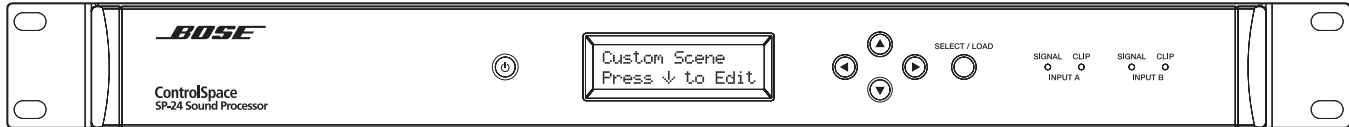

Thank you for choosing the Bose® ControlSpace® SP-24 sound processor.

The ControlSpace SP-24 sound processor is a flexible and easy-to-use digital signal processor for loudspeaker control with portable PA systems or small scale fixed installations. It offers two methods of configuration with front panel setup for situations where Bose® loudspeakers are being used, and the SP-24 Editor software for full-featured control of your sound with any loudspeaker.

This document delivers detailed installation and stand-alone configuration information. The information furnished in this guide is intended to help you install and set up the product, but does not include all details of design, production, or variations of the equipment. Nor does it cover every possible situation that may arise during installation, operation, or maintenance. If you need assistance beyond the scope of this guide, please contact your local Bose Representative or Technical Support Specialist listed in the Additional Resources section.

Key Features

- **Simplified front panel user interface** for selection of user-created Scenes or stand alone use with Bose loudspeakers.
- Built-in **Bose loudspeaker EQ library** supports Panaray, LT, MA12, MB4/12/24, and FreeSpace loudspeakers.
- **Balanced XLR** inputs (2) and XLR outputs (4).
- **USB port** for configuration, programming, signal level monitoring, and firmware updating.
- **Front panel LCD display and controls** allow access to important parameters such as input/output gains, input sensitivity, and delay.
- Input channel **signal and clip LED indicators**.
- **User Lockout** feature helps prevent unauthorized tampering of front panel interface.

ControlSpace SP-24 Editor software

The ControlSpace SP-24 Editor software enables full-featured control and monitoring of the SP-24 sound processor, allowing users to save, recall, and share customizable Scenes.

Additional Documentation

The following additional documents can help guide you through the setup and use of this product:

ControlSpace SP-24 sound processor Installation and Operating Guide

This document outlines safety warnings, precautions, basic setup, and configuration. A printed version of this guide is supplied with the unit and the most current version can be downloaded from pro.Bose.com.

ControlSpace SP-24 Editor User's Guide (PDF)

This document provides detailed instructions on how to use ControlSpace SP-24 Editor software to fully configure and update the unit. The most current version of this guide can be downloaded from pro.Bose.com and is included in the software help file.

Quick Start

1 Unpack

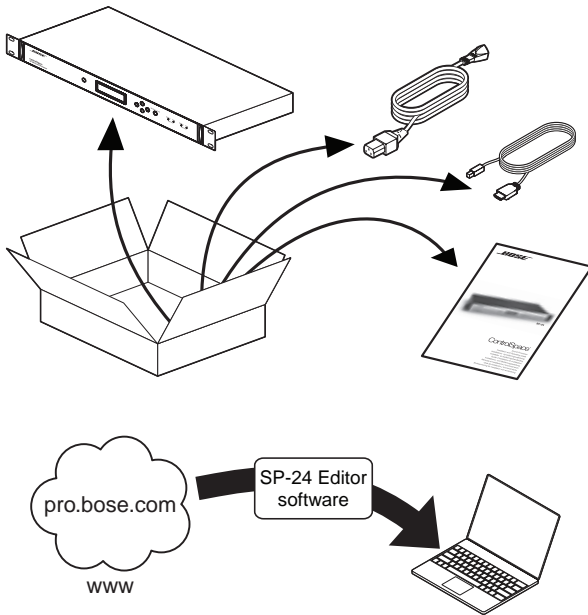

2 Install (optional)

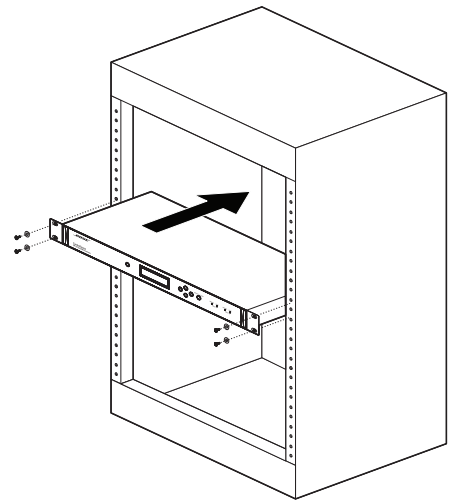

3 Connect

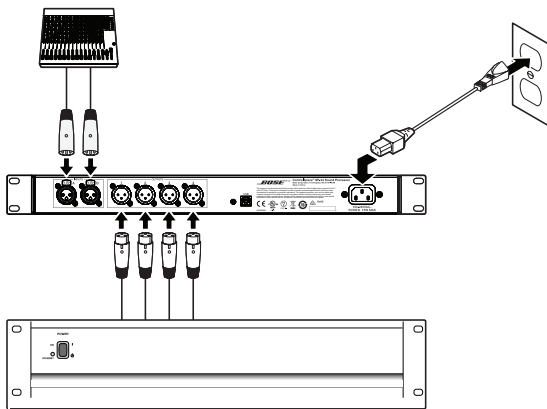

4 Configure

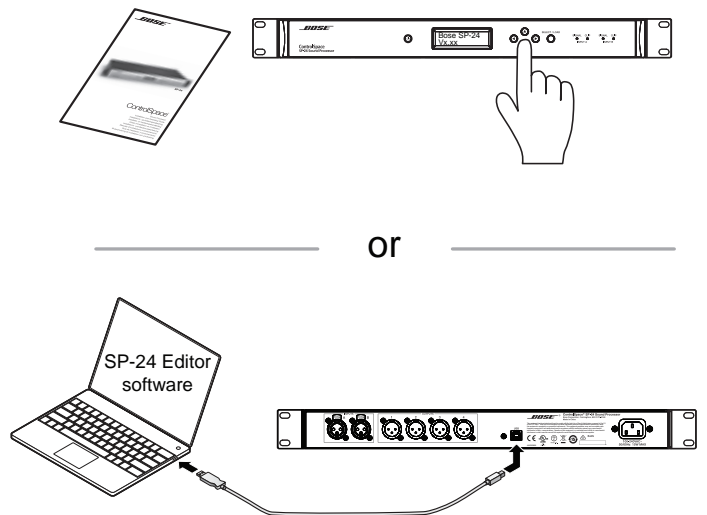

Product Overview

In the Box

The product box includes the following items:

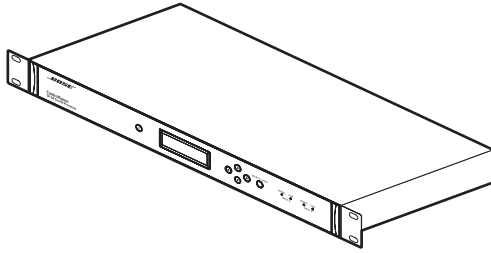

ControlSpace® SP-24 sound processor



Installation & Operating Guide

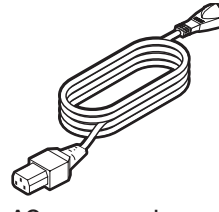

AC power cord

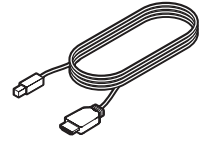

USB cable

Front Panel Controls and Indicators

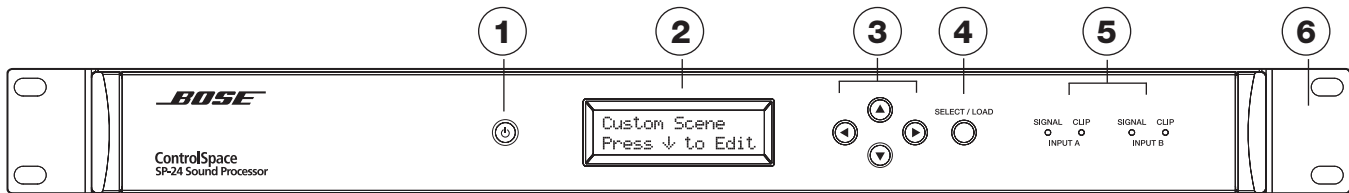

1. **Power button:** On/Off
2. **Display:** The 2 x 16 backlit LCD displays Preset names and parameter values.
3. **Navigation controls:** Press to navigate through the user interface.
4. **SELECT/LOAD:** Loads Presets and Custom Scenes. Saves Utility Menu parameters.
5. **SIGNAL/CLIP LEDs:** Illuminates to show signal and clipping indication for each input channel.
6. **Removable rack ears:** For use when installing unit into rack mount enclosures.

Rear Panel Connections

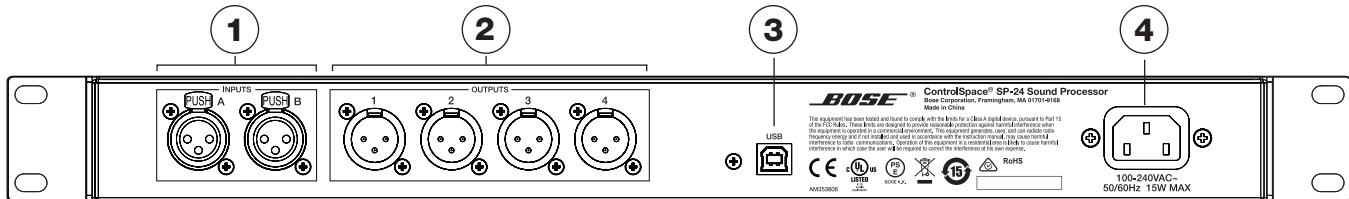

1. **Inputs A/B:** Balanced XLR Inputs.
2. **Outputs 1-4:** Balanced XLR Outputs.
3. **USB port:** B-type USB port for optional connection to PC running SP-24 Editor software.
4. **Input power:** Power cord input.

Hardware Installation

Rack Mounting the Chassis

The chassis requires one 1.75" (44 mm) rack space unit (1RU) in a standard 18" (457 mm) deep rack. To secure the chassis to the rack, use four screws with washers (not provided) to prevent marring the front panel.

Tip: Use of neoprene rubber washers are a good choice because they grip the screw head and prevent the screws from backing out from vibration or during transportation.

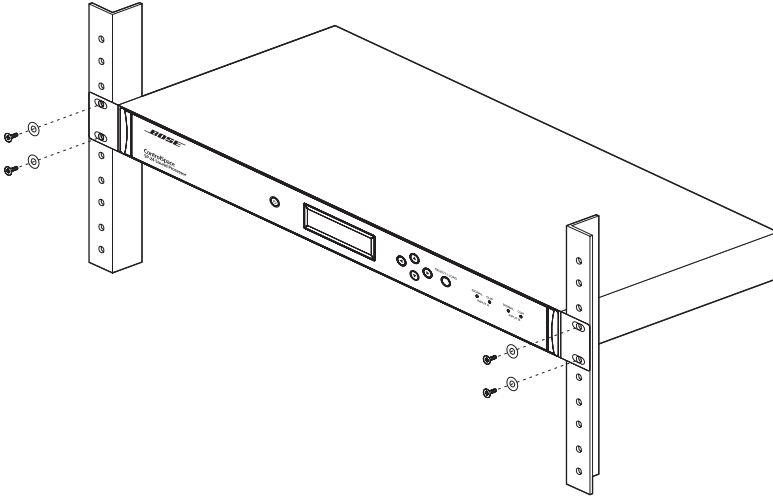

Spacing

When mounting adjacent to heat generating products such as power amplifiers, allow a 1RU open space between the SP-24 sound processor and the amplifier to allow for air flow.

Connections

Audio Connections

The ControlSpace® SP-24 sound processor has two balanced XLR analog inputs and four balanced XLR analog outputs for connection with a variety of professional-level audio equipment.

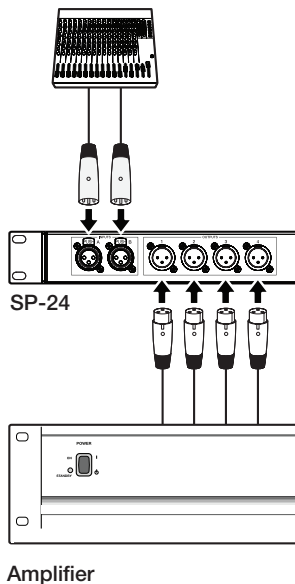

Power Connection

The ControlSpace SP-24 sound processor uses a universal power supply for worldwide use. AC power connection is made using the included power cord. Insert the proper power cord for the voltage used in your region.

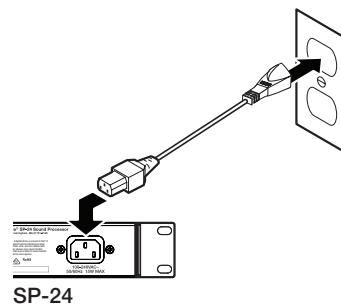

Balanced and Unbalanced Connections

The ControlSpace® SP-24 sound processor features balanced XLR connections which can be modified at the cable for use with unbalanced equipment. Although balanced connections are preferred, an unbalanced connection can be made by tying together pins 1 and 3.



USB Connection

When using the SP-24 Editor software, connect the supplied USB cable from the SP-24 sound processor to a PC. The USB cable should be used directly between the SP-24 sound processor and the computer.

Note: Use of docking stations or USB hubs is not recommended.

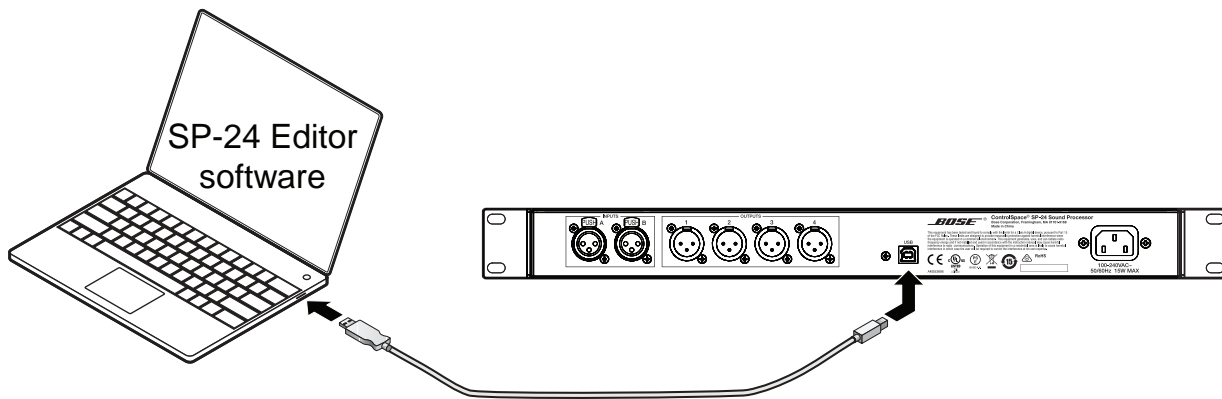

Note: The SP-24 Editor software and User's Guide are available for download from pro.Bose.com.

System Requirements

The following are the minimum system requirements for the SP-24 Editor software:

- Microsoft® Windows® XP Professional, Service Pack 2 (or later)
- Microsoft Windows 7 (Professional or Ultimate)
- Intel® Pentium® 4 850 Mhz processor (or better)
- Minimum screen resolution of 1280 x 768
- 512 MB RAM
- 100 MB disk space available
- USB connection

Front Panel Setup and Configuration

The ControlSpace® SP-24 sound processor has two methods of configuration. The unit may be configured using pre-defined operational modes and loudspeaker Presets from the front panel, or advanced Scenes and configurations may be created using the SP-24 Editor software. This section addresses the set up and configuration of the unit using the front panel.

For additional information related to the set up and configuration via the SP-24 Editor software, see the SP-24 Editor software User's Guide available at pro.Bose.com.

Note: The SP-24 Editor software requires the use of a PC running Windows XP or Windows 7 and an available USB port.

The table below outlines the features that can be accessed via the front panel of the sound processor and the ControlSpace SP-24 Editor software.

Function	Using Front Panel	Using SP-24 Editor Software
Load pre-configured mode w/ Bose® loudspeaker Preset	x	
Load Custom Scene	x	x
Set maximum input level (sensitivity)	x	x
Set input gain per channel	x	x
Mute input channels		x
Set input EQ per channel		x
Select custom channel routing		x
Set custom bandpass filter per channel		x
Select per channel Bose loudspeaker EQs		x
Set 9-band zone EQ per output channel		x
Set delay per output channel in feet or meters		x
Set delay per output channel in milliseconds	x	x
Set peak limiter per output channel		x
Set output gain	x	x
Mute output channels		x
Change phase 180 degrees per output channel		x
Enable User Lockout	x	
Perform a Factory Reset	x	
Open a Scene file stored on a PC		x
Save a Scene file to a PC		x
Send a Scene file to the SP-24 sound processor		x
Recall a Scene file from the SP-24 sound processor to the PC		x
Update SP-24 sound processor firmware		x
Input signal and clip indication	x	x
Detailed input and output metering		x
Output signal indication		x
Assign Bose loudspeakers EQs to individual output channels		x
Load discontinued Bose loudspeaker EQ		x

Front Panel User Interface

Front Panel Menu Structure Control Map

Front panel configuration is outlined in the following menu structure map.

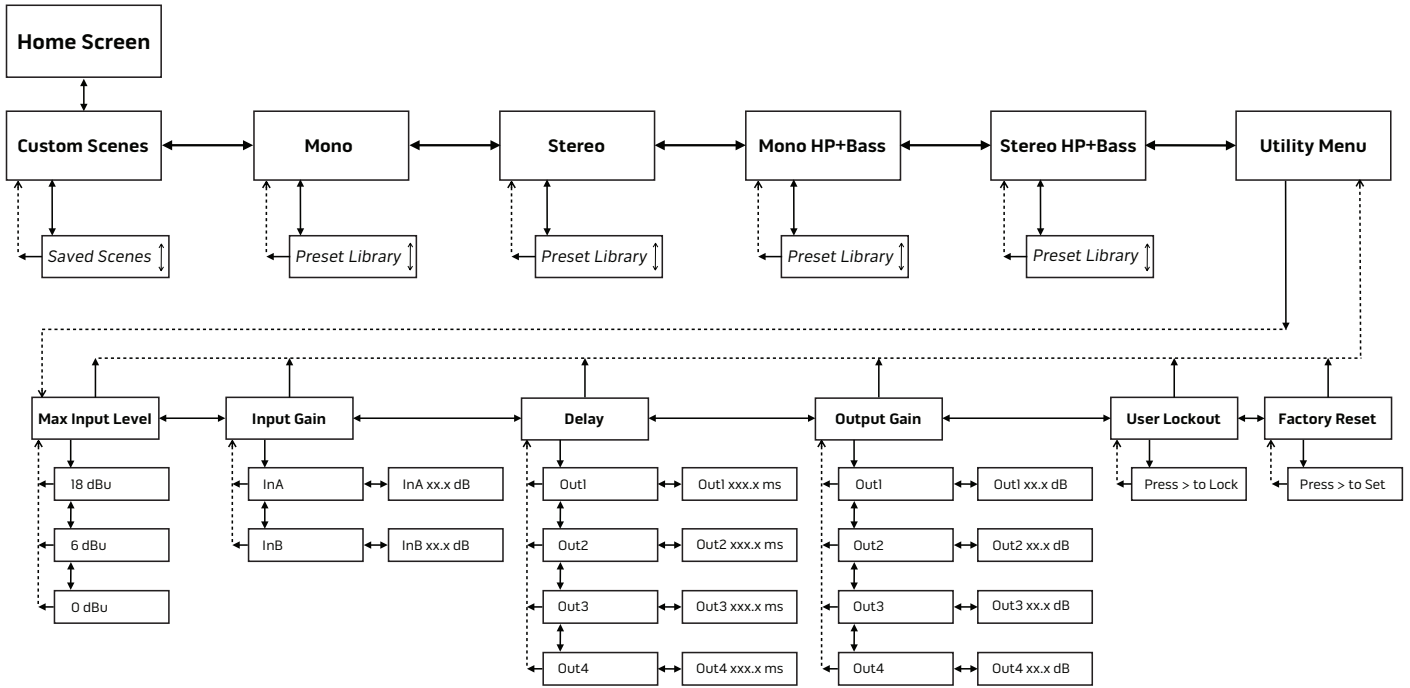

Note: When navigating down from the Home Screen, the active Preset Category or Scene Category will display.

Preset Modes

The ControlSpace® SP-24 sound processor comes pre-loaded with loudspeaker Presets for Bose® Professional loudspeakers. Updated loudspeaker Presets may be available and can be downloaded from pro.Bose.com. See, “Updating Firmware and Loudspeaker EQ Presets” on page 29 for instructions. Discontinued Bose loudspeaker EQs can be applied through the SP-24 Editor software.

Factory Fixed Routing Table

The loudspeaker Presets are linked to predefined modes for common configurations of current Bose loudspeakers. Discontinued Bose loudspeaker EQs can be loaded and applied via the SP-24 Editor software. The following table indicates how each Preset mode affects input channel routing and filtering at each of the four output channels.

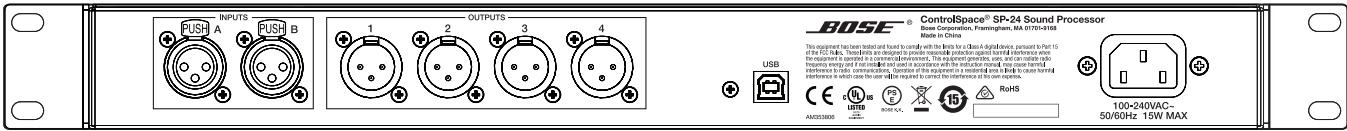

Output	Preset Category			
	Mono	Mono HP+Bass	Stereo	Stereo HP + Bass
1	A+B (Full Range)	A+B (HP Filter)	A (Full Range)	A (HP Filter)
2	A+B (Full Range)	A+B (HP Filter)	B (Full Range)	B (HP Filter)
3	A+B (Full Range)	A+B (LP Filter)	A (Full Range)	A+B (LP Filter)
4	A+B (Full Range)	A+B (LP Filter)	B (Full Range)	A+B (LP Filter)

Note: HP = High Pass (only high frequencies are passed)
 LP = Low Pass (only low frequencies are passed)
 Full Range = (all frequencies are passed)

Note: Other output configurations such as four discrete output channels, can be designed using the SP-24 Editor software.

Loading Presets

1. From the home screen, press to edit.
2. Use to navigate to the desired Preset category.
3. Use to locate the desired Preset.
4. Press the **SELECT/LOAD** button to load the Preset.

Note: On LCD display, an asterisk (*) indicates the currently loaded Preset.

Custom Scenes

The ControlSpace SP-24 sound processor supports the creation of four unique Custom Scenes which may be recalled from either the front panel or via the SP-24 Editor software. Each Scene represents a unique configuration of comprehensive signal processing parameters which are immediately implemented when the scene is recalled. For detailed information on creating Custom Scenes, download the ControlSpace SP-24 Editor User’s Guide from pro.Bose.com.

To recall a saved Custom Scene using the front panel controls on the sound processor:

1. From the Home Screen, press to edit.
2. Use to navigate to **Custom Scenes**.
3. Use to locate desired Custom Scene.
4. Press the **SELECT/LOAD** button to load the selected Custom Scene.

Note: Any parameters set previously in the Utility Menu will be overwritten with data stored in the Custom Scene.

Utility Menu

The Utility Menu allows you to make limited adjustments to the SP-24 sound processor from the front panel. More advanced configurations can be created using the SP-24 Editor software.

Saving Settings

In the Utility Menu, changes to a parameter setting can be stored immediately by pressing **SELECT/LOAD** or will automatically store after sixty seconds of inactivity. To exit the parameter screen, press .



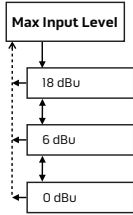

Note: When entering a parameter screen, the initial value displayed is the current active parameter setting.

Max Input Level

Select the maximum input level for both A and B inputs. There are three selectable values: 0 dBu, 6 dBu, and 18 dBu. Using documentation for the audio source device, determine the maximum output level and select the corresponding values on the SP-24 sound processor. If the maximum input level for the source is higher than 18 dBu, either limit the output of the source using a master output control or use an inline pad to reduce the maximum level to 18 dBu or less.



To set Max Input Level:



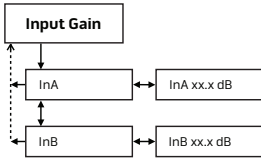

1. Navigate to **Max Input Level** in the Utility Menu.
2. Press .
3. Use   to select the desired maximum input level.
4. Press **SELECT/LOAD** to save the setting.
5. Press  to exit.

Input Gain

Set the input gain for each input. Range of control: -60 dB to 12 dB; 0.5 dB increments.



To set Input Gain:



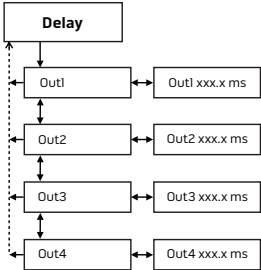

1. Navigate to **Input Gain** in the Utility Menu.
2. Press  to locate the desired input channel (InA or InB).
3. Press  to select.
4. Use   to set the input gain.
5. Press **SELECT/LOAD** to save the setting.
6. Press  to exit.

Delay

Set the output delay independently for each output channel. Range of control: 0 ms to 170 ms; 0.5 ms increments.



To set Delay:



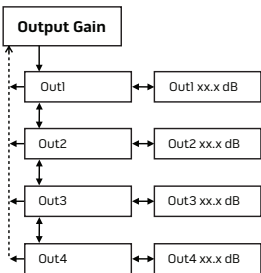

1. Navigate to **Delay** in the Utility Menu.
2. Press  to locate the desired channel (Out1, Out2, Out3, Out4).
3. Press  to select.
4. Use   to set the delay.
5. Press **SELECT/LOAD** to save the setting.
6. Press  to exit.

Output Gain

Set the output gain independently for each channel. Range of control: -60 dB to 0 dB; 0.5 dB increments.



To set Output Gain:



1. Navigate to **Output Gain** in the Utility Menu.
2. Press  to locate the desired output channel (Out1, Out2, Out3, Out4).
3. Press  to select.
4. Use   to set the output gain.
5. Press **SELECT/LOAD** to save the setting.
6. Press  to exit.

User Lockout

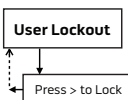
Locks the navigation buttons to prevent tampering with the settings. When Lockout is engaged, the current state of the controller is fixed. User Lockout does not prevent access by the SP-24 Editor access via USB.





To lock:

1. Navigate to **User Lockout** in the Utility Menu.
2. Press .
3. Select  to engage lockout or press  to abort.
4. Sound processor will automatically return to a locked Home Screen.

Home Screen

To unlock:



1. From Home Screen, press  until **Lockout ON No Access** is displayed.
2. Press   together for 5 seconds.
3. Screen will display **Lockout OFF Full Access**.
4. Sound processor will automatically revert to the unlocked Home Screen.

Factory Reset

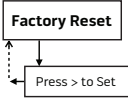
Resets the system controller to the factory default settings.



To reset the controller:

1. Navigate to **Factory Reset** in the Utility Menu.
2. Press .
3. Press  to set or press  to abort.
4. Sound processor will automatically reset to the factory settings and return to the Home Screen.

Updating Firmware and Loudspeaker EQ Presets

Both the device firmware and Bose® loudspeaker Presets contained within the ControlSpace SP-24 sound processor can be updated using the ControlSpace® SP-24 Editor software. To obtain the newest versions of firmware and EQ files, go to pro.Bose.com. For more information about updating the firmware and loudspeaker EQ Presets, please refer to the ControlSpace SP-24 Editor User's Guide

SP-24 Editor PC Application

Features and Capabilities

The ControlSpace SP-24 Editor software is used for the set up, configuration and control of the Bose ControlSpace SP-24 sound processor. The SP-24 Editor provides access to all functions within the processor, and from within the application you may create Custom Scenes and store them within the processor. Up to four Custom Scenes may be stored to the SP-24 sound processor.

Additional information on the design and configuration of systems using the ControlSpace SP-24 sound processor can be found at pro.Bose.com.

The ControlSpace SP-24 sound processor employs a fixed signal processing architecture which includes the following signal processing functions accessed using the SP-24 Editor software:

- **Input and Output Level Controls**
 - Input sensitivity (Max Input Level) and gain controls regulate signals entering the SP-24 sound processor while output gain controls set the output level of the product (up to 18dBu).
- **Multiple 9-Band EQ Stages**
 - Each input and output signal processing chain includes a 9-band Dual EQ, which can be operated as a 9-band graphic or parametric equalizer.
- **Routing**
 - Allows you to set the source for each output channel: A, B, A+B, or none.
- **Band Pass Crossover**
 - The Band Pass Crossover function provides a single mono crossover for the output signal processing chain.
- **Bose Loudspeaker EQ**
 - Each output signal processing chain includes a dedicated Bose Loudspeaker EQ stage.
- **Signal Delay**
 - Up to 170 milliseconds of signal delay may be applied to each for the four output channels.
- **Signal Limiter**
 - Each output signal processing stage includes a peak value signal limiter with a fixed attack value of 1 millisecond and a fixed release value of 1 second.

Software Download and User's Guide

The ControlSpace SP-24 Editor software and User's Guide can be downloaded from pro.Bose.com.

Sample Output Configurations

Stereo Preset Bank: Presets designed for full range stereo operation.

Stereo Full Range			
Example:	Stereo input with stereo output to two Panaray® 802® Series III loudspeakers.		
Preset	<div style="border: 1px solid black; padding: 5px; display: inline-block;"> Stereo *802III </div>		
Inputs:	A: Left from mixer B: Right from mixer		
Routing: (default)	Channel 1:	802-III Left	Full Range
	Channel 2:	802-III Right	Full Range
	Channel 3:	802-III Left	Full Range (not used in setup below)
	Channel 4:	802-III Right	Full Range (not used in setup below)

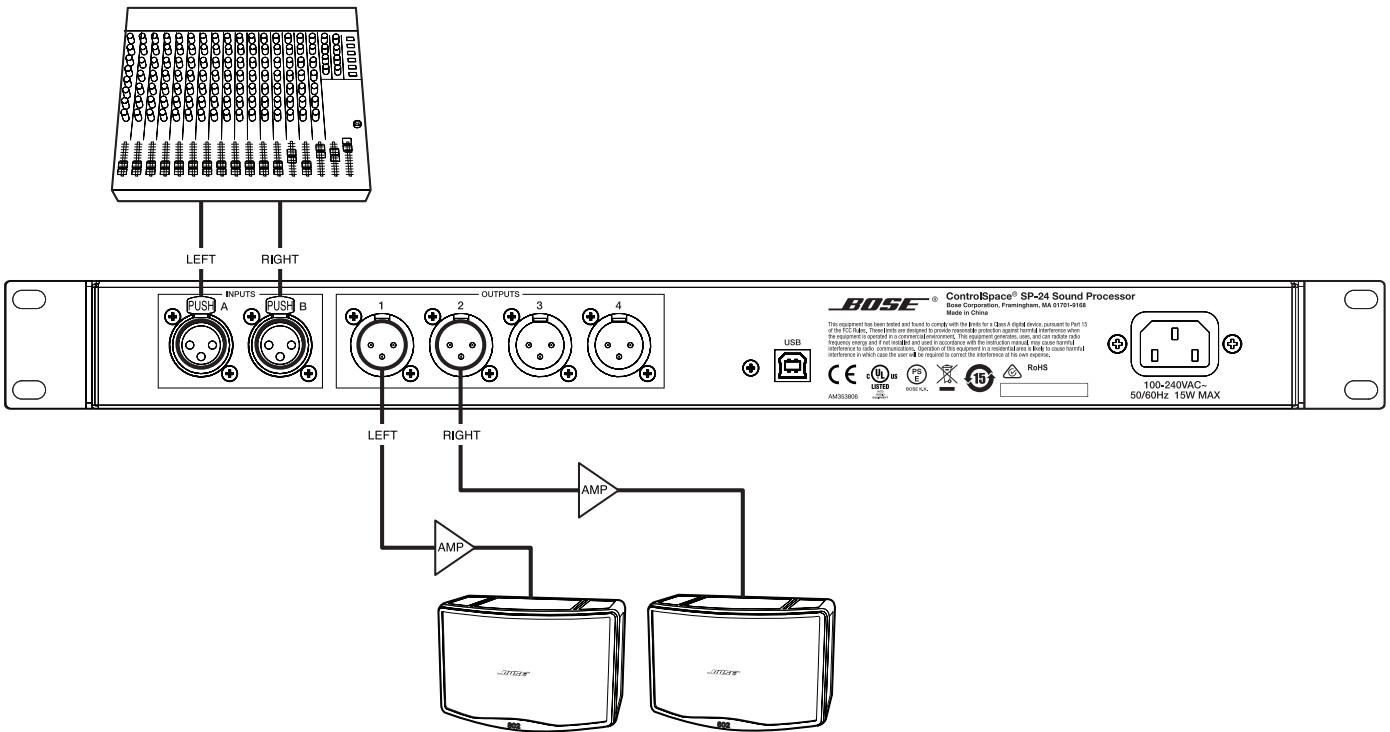

Stereo High Pass + Bass Preset Bank: Presets designed for stereo high pass operation on channels 1 and 2, and mono low pass operation on channels 3 and 4.

Stereo Mid-High with Mono Bass		
Example:	Stereo input with stereo output to two LT 4402 WR loudspeakers and mono output to one MB24 WR.	
Preset	<div style="border: 1px solid black; padding: 5px; display: inline-block;"> Stereo HP+Bass *LT4402+MB </div>	
Inputs:	A: Left from mixer B: Right from mixer	
Routing: (default)	Channel 1:	LT 4402 WR Left High Pass
	Channel 2:	LT 4402 WR Right High Pass
	Channel 3:	MB24 WR Mono (Left + Right) Low Pass
	Channel 4:	MB24 WR Mono (Left + Right) Low Pass (not used in setup below)

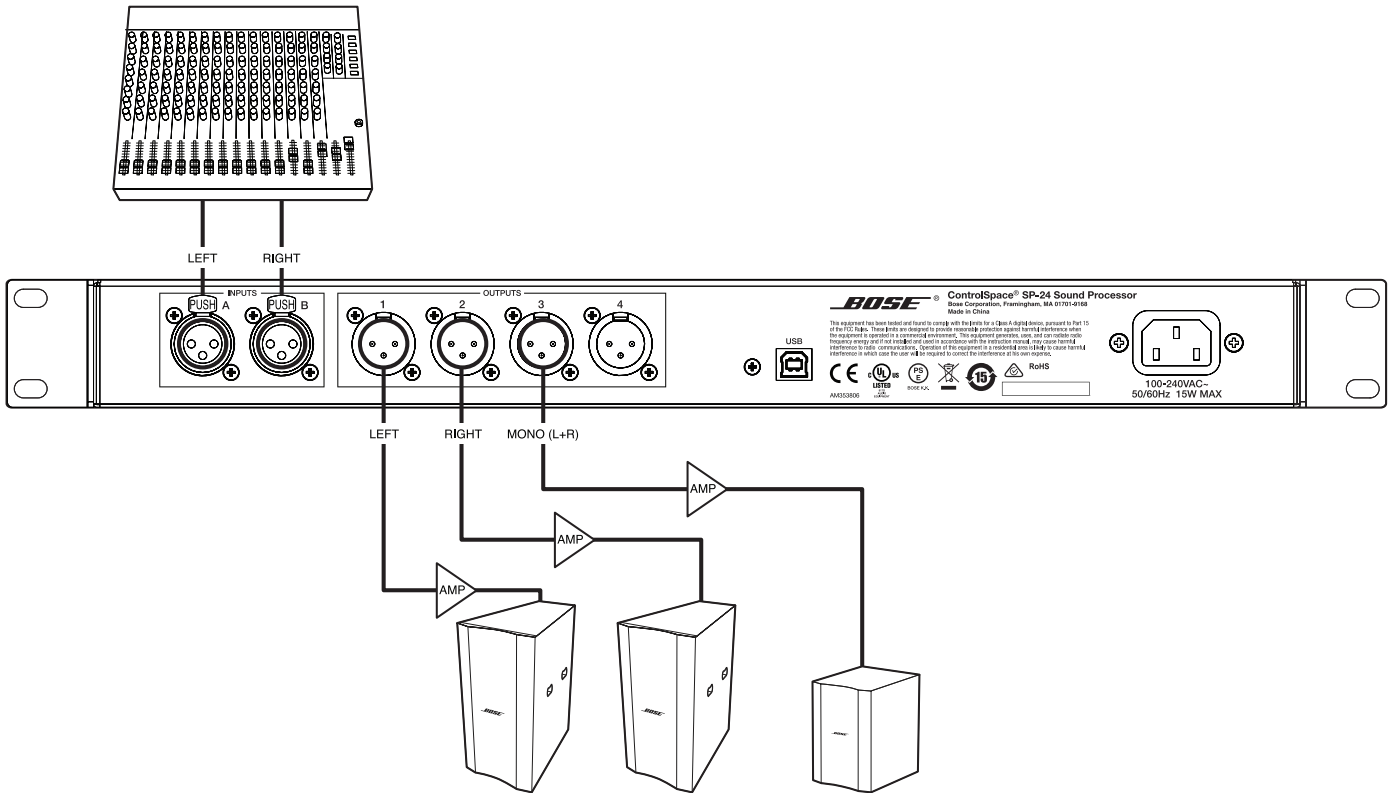

Mono Preset Bank: Presets designed for 4-channel full range mono operation.

Mono Full Range			
Example:	Mono input with mono output to four Panaray® 402® Series II loudspeakers.		
Preset	<div style="border: 1px solid black; padding: 5px; display: inline-block;"> Mono *402II </div>		
Inputs:	A: Mono from mixer B: No input		
Routing: (default)	Channel 1:	402 II Mono	Full Range
	Channel 2:	402 II Mono	Full Range
	Channel 3:	402 II Mono	Full Range
	Channel 4:	402 II Mono	Full Range

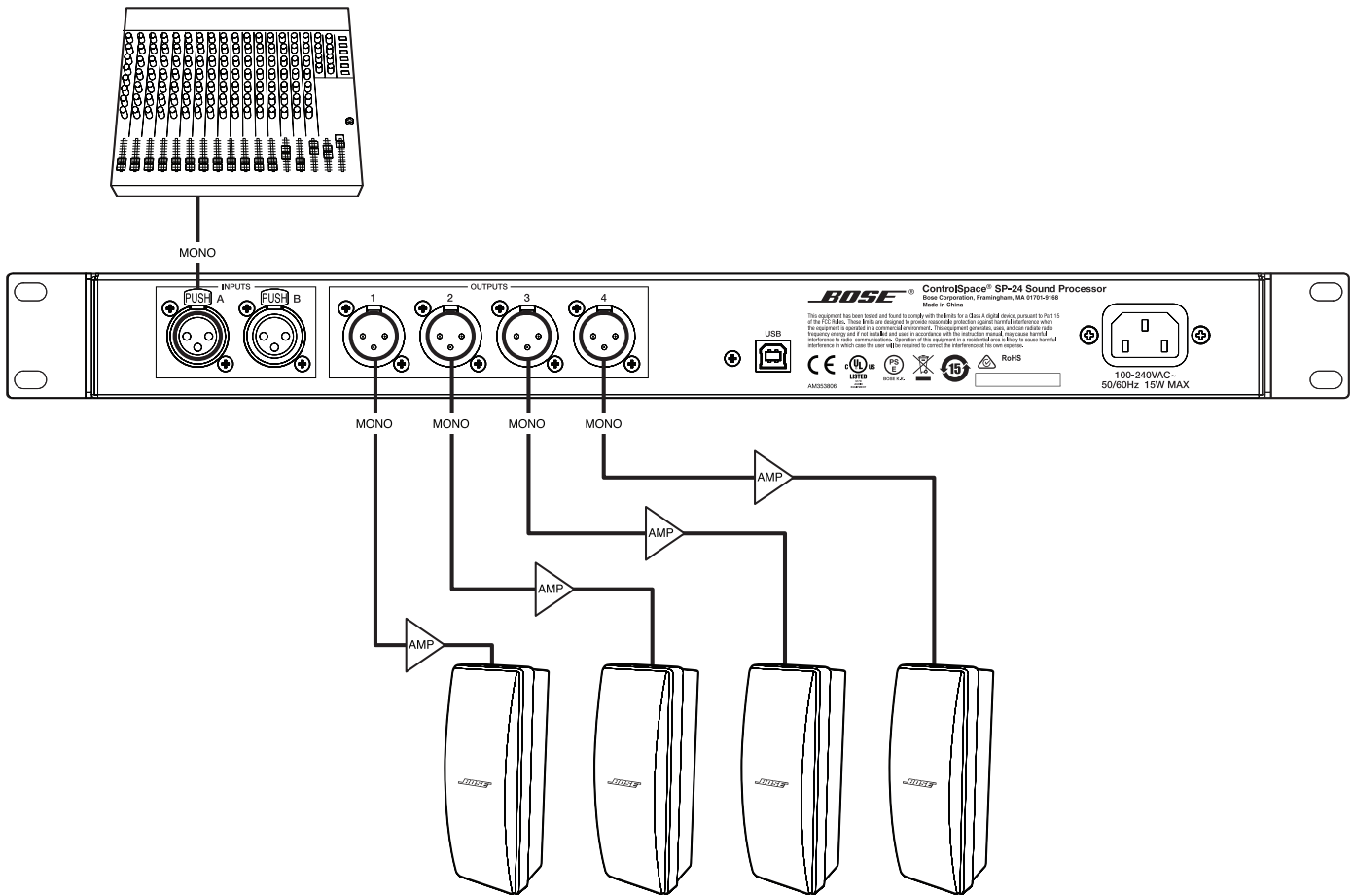

Mono High Pass + Bass Preset Bank: Presets designed for mono high pass operation on channels 1 and 2, and mono low pass on channels 3 and 4.

Mono Mid-High with Mono Bass			
Example:	Stereo input with mono output to two FreeSpace® DS 40SE loudspeakers and one Panaray® MB4 bass module. Output summed to mono (L+R).		
Preset	Mono HP+Bass *DS40+MB		
Inputs:	A: Left from mixer B: Right from mixer		
Routing: (default)	Channel 1:	DS 40SE Mono (Left + Right)	High Pass
	Channel 2:	DS 40SE Mono (Left + Right)	High Pass
	Channel 3:	MB4 Mono (Left + Right)	Low Pass
	Channel 4:	MB4 Mono (Left + Right)	Low Pass (not used in setup below)

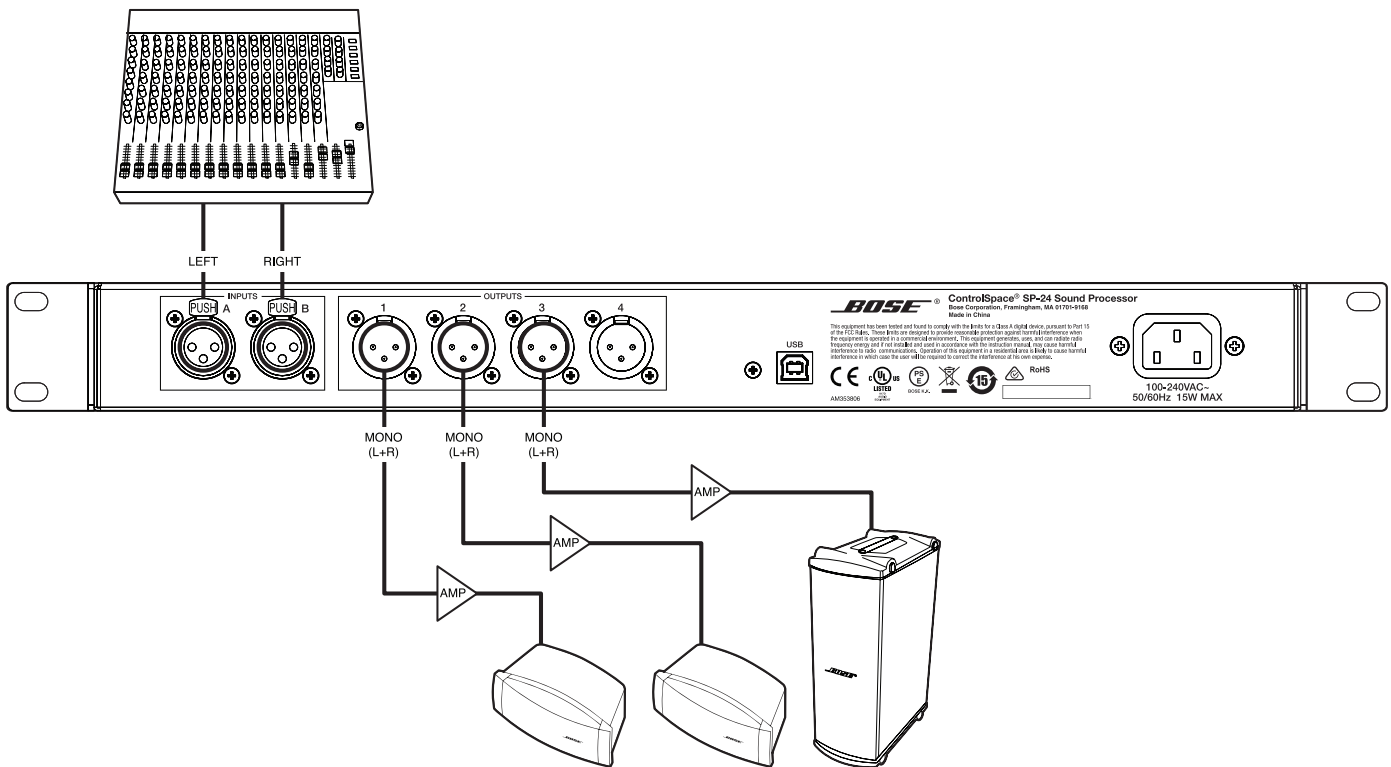

Troubleshooting

Problem	Possible Solution
No or intermittent power	<ul style="list-style-type: none"> • Turn on power. • Verify that the power cord is securely connected to the unit and power outlet. • Verify that the power outlet and power extension cords (if used) are functional. • Try connecting the SP-24 sound processor to a different power circuit.
Power is on, but low or no sound	<ul style="list-style-type: none"> • Make sure the source device is turned on. • Check that the cables from the source to the SP-24 sound processor are fully connected and that the cables are functional. • Check that the cables from the SP-24 sound processor to the amplifier or powered loudspeaker are fully connected and that the cables are functional. • Check that the amplifier or powered loudspeaker is on or that the amplifier is correctly connected to the loudspeaker. • Verify that there is an input signal from the source. The Audio Input signal indicator on the front of the SP-24 sound processor should show green. • If connected to the SP-24 Editor software, ensure that all parameters, especially Input/Output Gain blocks, Router blocks, and Mute controls are all set correctly. • If setup was done from the front panel interface, check loudspeaker Preset or Custom Scene. • Check Input/Output gain values via the Utility Menu. • Check Input levels via Utility Menu.
Sound is distorted	<ul style="list-style-type: none"> • Verify that the Input Clip indicators are not lit (red). If an LED is red, change the Max Input Level setting and/or Input Gain to better match source output level. • If Max Input Level is set to 18 dBu and still Clip results, reduce the source Output level by reducing Output Gain from the source or apply an inline attenuator device (pad). • If the SP-24 sound processor is not showing Clip, reduce the Output Gain. • Use the SP-24 Editor software to gain full control and visibility to Input and Output levels. Adjust for optimal gain staging using the meters. • Verify that the loudspeakers are not overdriven or damaged by the amplifier.
Unnatural sound	<ul style="list-style-type: none"> • Verify that the correct Bose® loudspeaker EQ is selected. • Check that Output connections are wired to the correct loudspeaker channel as selected in a Preset or Custom Scene. • In the SP-24 Editor software, check the Limiter settings. • In the SP-24 Editor software, check that the output polarity controls (Output Gain block) are set the same for loudspeakers in the same system. • Verify that the polarity of the signal chain is correct (input cabling, output cabling, amplifier output channels to loudspeaker).
Poor signal to noise performance (hiss)	<ul style="list-style-type: none"> • Set the Max Input Level parameter for 18 dBu. Ensure source device level is ideally delivering a nominal 0 dBu signal. • Set the Input Gain parameter for each input channel so that the Max Input Level is just under clip level. • Using the SP-24 Editor software, adjust the Limiter and Output Gain blocks for optimal output levels so they match the input signal capabilities of the connected amplifier or powered loudspeaker. (Example: An amplifier capable of 18 dBu input should receive peak signals from the SP-24 sound processor as close to 18 dBu as possible.)

Problem	Possible Solution
Buzz or hum noise	<ul style="list-style-type: none"> • If there are multiple high-power devices connected to the same AC circuit, disconnect some of them or connect the SP-24 sound processor to a different circuit. • Plug the power cord for the SP-24 sound processor as close as possible to the source and output device (amplifier or powered loudspeaker). • Use balanced cables and connections. • Physically separate audio cables from the power cables. • Try a different audio source. • Replace the cables connecting the source (i.e., the mixer and signal processors), amp, and speakers to the SP-24 sound processor. • Use a line tester to verify that the power outlets and power extensions (if used) are properly grounded. • Use an inline XLR ground lift on the affected channels.
USB device not recognized	<ul style="list-style-type: none"> • Ensure your computer meets the minimum requirements. • Use the supplied USB cable. • Remove any USB extension cables or USB hubs between the PC and the SP-24 sound processor. • Undock PC from docking station – use USB connection directly to PC. • Reinstall the SP-24 Editor software. • Unplug any other USB-based devices. • Disconnect and reconnect the USB cable at both ends. • Try another USB connector on the computer. • Disconnect the USB cable, power cycle both the SP-24 sound processor and PC. Reconnect cable and turn on devices.
Front panel control offers limited programmability	<ul style="list-style-type: none"> • Use the SP-24 Editor software to make full-featured adjustments. Store this custom configuration to the SP-24 sound processor as a Custom Scene.
Settings not retained	<ul style="list-style-type: none"> • Be sure to press the SELECT/LOAD button on the desired Preset, Custom Scene, or Utility Menu parameter to save the selection.
Pop is heard when powering on	<ul style="list-style-type: none"> • Power on the external amplifier/powering on the source device and the SP-24 sound processor.

Appendix

Technical Specifications

Audio Performance Specifications	
Frequency Response	20 Hz - 20 kHz (+0/-1 dB)
THD+N	0.015% (typical)
Channel Separation (Crosstalk)	100 dB (typical)
Dynamic Range	107 dB (typical)
Integrated DSP	
Audio Latency	1.52 ms
A/D and D/A Converters	24-bit
Sample Rate	48 kHz
Audio Inputs	
Inputs	2 analog, balanced, differential
Connectors, Input	XLR
Input Impedance	Differential 2.2 k Ω @ 1 kHz
Maximum Input Level	+18 dBu
Sensitivity	Selectable: 0/+6/+18 dBu
Audio Outputs	
Outputs	4 analog, balanced, differential
Connectors, Output	XLR
Output Impedance	Differential 200 Ω
Maximum Output Level	+18 dBu
Indicators and Controls	
Audio Indicators	Input signal present (Green LED) Input signal clip (Red LED)
Electrical Specifications	
Mains Voltage	100 VAC - 240 VAC (+/- 10%, 50/60 Hz)
AC Power Consumption	200 W maximum
AC Mains Connector	Standard IEC (C14)
Power Dissipation	52 BTU (13.1 kcal)
Physical	
Rack Space Units	1 RU
Dimensions	1.8" H x 19.0" W x 8.6" D (45 mm x 483 mm x 218 mm)
Net Weight	5.9 lb (2.7 kg)
Shipping Weight	8.6 lb (3.9 kg)
Operating Temperature	32 °F - 113 °F (0 °C - 45 °C)
Storage Temperature	-40 °F - 158 °F (-40 °C - 70 °C)
Humidity	95% relative humidity, maximum
General	
Communication Port	USB Type B (rear panel), PC interface

Mechanical Diagrams

Back View

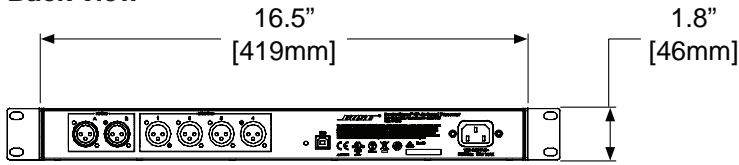

Front View

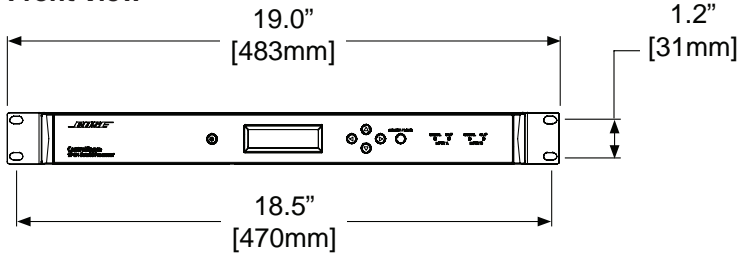

Right View

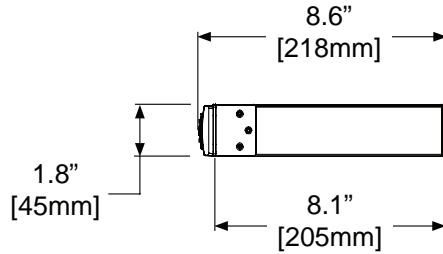

Utility Menu Ranges

Utility Menu	Adjustment Range	Affected Channels
Max Input Level	0, +6, or +18 dBu	Inputs A and B (ganged control)
Input Gain	-60 dBFS to +12 dBFS; 0.5 dB increments	Input A, B
Delay	0 to 170 ms; 0.5 ms increments	Output: 1, 2, 3, 4
Output Gain	-60 dBFS to 0 dBFS; 0.5 dB increments	Output: 1, 2, 3, 4

Routing Categories for Preset Modes

Mono

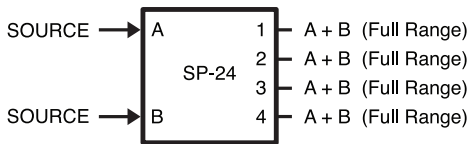

Stereo

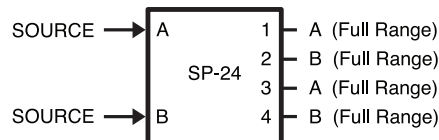

Mono HP + Bass

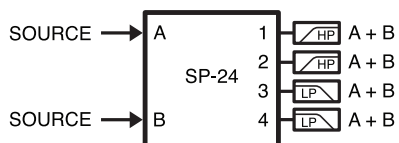

Stereo HP + Bass

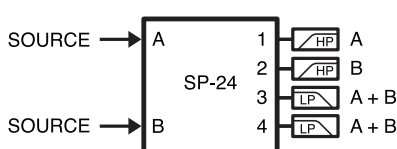

Additional Resources

Visit us on the web at **pro.Bose.com** for more information, including specifications, technical literature, product warranty, parts and accessories, and global support contact information.

Americas

(USA, Canada, Mexico, Central America, South America)
Bose Corporation
The Mountain
Framingham, MA 01701 USA
Corporate Center: 508-879-7330
Americas Professional Systems,
Technical Support: 800-994-2673

Australia

Bose Pty Limited
Unit 3/2 Holker Street
Newington NSW Australia
61 2 8737 9999

Belgium

Bose N.V. / S.A
Limesweg 2, 03700
Tongeren, Belgium
012-390800

China

Bose Electronics (Shanghai) Co. Ltd.
36F, West Gate Tower
1038 West Nanjing Road
Shanghai, P.R.C. 200041 China
86 21 6271 3800

France

Bose S.A.S
12 rue de Temara 78100
St. Germain-en-Laye, France
01-30616363

Germany

Bose GmbH
Max-Planck Strasse 36D 61381
Friedrichsdorf, Deutschland
06172-7104-0

Hong Kong

Bose Limited
Suites 2101-2105, Tower One, Times Square
1 Matheson Street, Causeway Bay, Hong Kong
852 2123 9000

India

Bose Corporation India Private Limited
4th Floor, Shriram Bhartiya Kala Kendra
1, Copernicus Marg
New Delhi 110001, India
91 11 23073825

Italy

Bose SpA
Via Della Magliana 87600148
Rome, Italy
066-5670802

Japan

Bose K.K., Shibuya YT Building
28-3 Maruyama-sho
Shibuya-ku, Tokyo 150
TEL 3-5489-0955
www.bose.co.jp

The Netherlands

Bose BV
Nijverheidstraat 8 1135 GE
Edam, Nederland
0299-390139

United Kingdom

Bose Ltd
1 Ambley Green, Gillingham Business Park
KENT ME8 0NJ
Gillingham, England
0870-741-4500

See website for other countries.



BOSE[®]
Better sound through research[®]

© 2012 Bose Corporation. All rights reserved.
The Mountain, Framingham, MA 01701-9168 USA
www.pro.Bose.com
All trademarks are the property of their respective owners.
AM354951 Rev. 00