

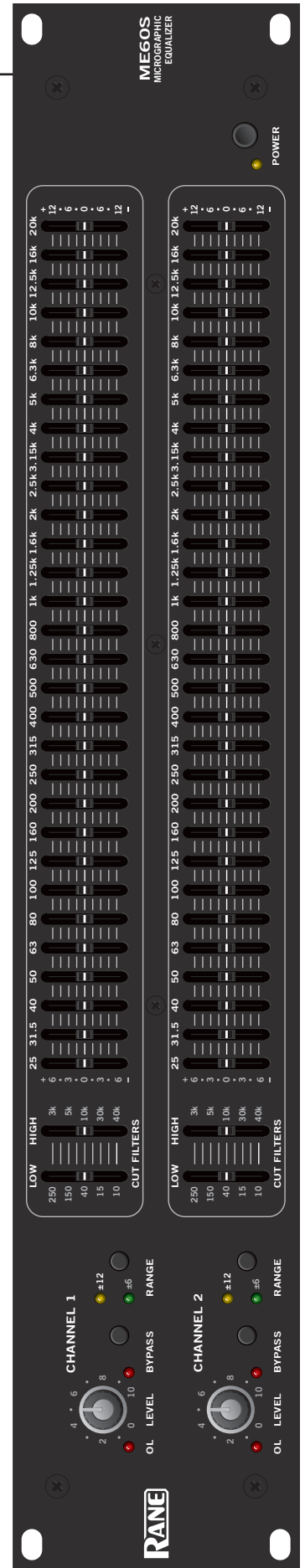

# ME60S

microGRAPHIC EQUALIZER



## CONTENTS *(in order of appearance)*

Important Safety Instructions

ME60S Manual

ME60S Data Sheet

Sound System Interconnection

Warranty

Declaration of Conformity

Schematics are downloadable at [www.rane.com/me60s.html](http://www.rane.com/me60s.html)

22347

# IMPORTANT SAFETY INSTRUCTIONS



1. Read these instructions.
  2. Keep these instructions.
  3. Heed all warnings.
  4. Follow all instructions.
  5. Do not use this apparatus near water.
  6. Clean only with a dry cloth.
  7. Do not block any ventilation openings. Install in accordance with manufacturer's instructions.
  8. Do not install near any heat sources such as radiators, registers, stoves, or other apparatus (including amplifiers) that produce heat.
  9. Do not defeat the safety purpose of the polarized or grounding-type plug. A polarized plug has two blades with one wider than the other. A grounding-type plug has two blades and a third grounding prong. The wide blade or third prong is provided for your safety. If the provided plug does not fit into your outlet, consult an electrician for replacement of the obsolete outlet.
  10. Protect the power cord and plug from being walked on or pinched particularly at plugs, convenience receptacles, and the point where it exits from the apparatus.
  11. Only use attachments and accessories specified by Rane.
  12. Use only with the cart, stand, tripod, bracket, or table specified by the manufacturer, or sold with the apparatus. When a cart is used, use caution when moving the cart/apparatus combination to avoid injury from tip-over.
  13. Unplug this apparatus during lightning storms or when unused for long periods of time.
  14. Refer all servicing to qualified service personnel. Servicing is required when the apparatus has been damaged in any way, such as power supply cord or plug is damaged, liquid has been spilled or objects have fallen into the apparatus, the apparatus has been exposed to rain or moisture, does not operate normally, or has been dropped.
  15. The plug on the power cord is the AC mains disconnect device and must remain readily operable. To completely disconnect this apparatus from the AC mains, disconnect the power supply cord plug from the AC receptacle.
  16. This apparatus shall be connected to a mains socket outlet with a protective earthing connection.
  17. When permanently connected, an all-pole mains switch with a contact separation of at least 3 mm in each pole shall be incorporated in the electrical installation of the building.
  18. If rackmounting, provide adequate ventilation. Equipment may be located above or below this apparatus, but some equipment (like large power amplifiers) may cause an unacceptable amount of hum or may generate too much heat and degrade the performance of this apparatus.
  19. This apparatus may be installed in an industry standard equipment rack. Use screws through all mounting holes to provide the best support.
- WARNING:** To reduce the risk of fire or electric shock, do not expose this apparatus to rain or moisture. Apparatus shall not be exposed to dripping or splashing and no objects filled with liquids, such as vases, shall be placed on the apparatus.

## WARNING



To reduce the risk of electrical shock, do not open the unit. No user serviceable parts inside. Refer servicing to qualified service personnel.

The symbols shown below are internationally accepted symbols that warn of potential hazards with electrical products.



This symbol indicates that a dangerous voltage constituting a risk of electric shock is present within this unit.



This symbol indicates that there are important operating and maintenance instructions in the literature accompanying this unit.

**WARNING:** This product may contain chemicals known to the State of California to cause cancer, or birth defects or other reproductive harm.

**NOTE:** This equipment has been tested and found to comply with the limits for a Class B digital device, pursuant to part 15 of the FCC Rules. These limits are designed to provide reasonable protection against harmful interference in a residential installation. This equipment generates, uses and can radiate radio frequency energy and, if not installed and used in accordance with the instructions, may cause harmful interference to radio communications. However, there is no guarantee that interference will not occur in a particular installation. If this equipment does cause harmful interference to radio or television reception, which can be determined by turning the equipment off and on, the user is encouraged to try to correct the interference by one or more of the following measures:

- Reorient or relocate the receiving antenna.
- Increase the separation between the equipment and receiver.
- Connect the equipment into an outlet on a circuit different from that to which the receiver is connected.
- Consult the dealer or an experienced radio/TV technician for help.

**CAUTION:** Changes or modifications not expressly approved by Rane Corporation could void the user's authority to operate the equipment.

# INSTRUCTIONS DE SÉCURITÉ



1. Lisez ces instructions.
2. Gardez précieusement ces instructions.
3. Respectez les avertissements.
4. Suivez toutes les instructions.
5. Ne pas utiliser près d'une source d'eau.
6. Ne nettoyer qu'avec un chiffon doux.
7. N'obstruer aucune évacuation d'air. Effectuez l'installation en suivant les instructions du fabricant.
8. Ne pas disposer près d'une source de chaleur, c-à-d tout appareil produisant de la chaleur sans exception.
9. Ne pas modifier le cordon d'alimentation. Un cordon polarisé possède 2 lames, l'une plus large que l'autre. Un cordon avec tresse de masse possède 2 lames plus une 3<sup>e</sup> pour la terre. La lame large ou la tresse de masse assurent votre sécurité. Si le cordon fourni ne correspond pas à votre prise, contactez votre électricien.
10. Faites en sorte que le cordon ne soit pas piétiné, ni au niveau du fil, ni au niveau de ses broches, ni au niveau des connecteurs de vos appareils.
11. N'utilisez que des accessoires recommandés par Rane.
12. N'utilisez que les éléments de transport, stands, pieds ou tables spécifiés par le fabricant ou vendu avec l'appareil. Quand vous utilisez une valise de transport, prenez soin de vous déplacer avec cet équipement avec prudence afin d'éviter tout risque de blessure.
13. Débranchez cet appareil pendant un orage ou si vous ne l'utilisez pas pendant un certain temps.
14. Adressez-vous à du personnel qualifié pour tout service après vente. Celui-ci est nécessaire dans n'importe quel cas où l'appareil est abîmé : si le cordon ou les fiches sont endommagés, si du liquide a été renversé ou si des objets sont tombés sur l'appareil, si celui-ci a été exposé à la pluie ou l'humidité, s'il ne fonctionne pas correctement ou est tombé.
15. La fiche du cordon d'alimentation sert à brancher le courant alternatif AC et doit absolument rester accessible. Pour déconnecter totalement l'appareil du secteur, débranchez le câble d'alimentation de la prise secteur.
16. Cet appareil doit être branché à une prise terre avec protection.
17. Quand il est branché de manière permanente, un disjoncteur tripolaire normalisé doit être incorporé dans l'installation électrique de l'immeuble.
18. En cas de montage en rack, laissez un espace suffisant pour la ventilation. Vous pouvez disposer d'autres appareils au-dessus ou en-dessous de celui-ci, mais certains (tels que de gros amplificateurs) peuvent provoquer un buzz ou générer trop de chaleur au risque d'endommager votre appareil et dégrader ses performances.
19. Cet appareil peut-être installé dans une baie standard ou un châssis normalisé pour un montage en rack. Visser chaque trou de chaque oreille de rack pour une meilleure fixation et sécurité.

**ATTENTION:** afin d'éviter tout risque de feu ou de choc électrique, gardez cet appareil éloigné de toute source d'humidité et d'éclaboussures quelles qu'elles soient. L'appareil doit également être éloigné de tout objet possédant du liquide (boisson en bouteilles, vases,...).

## ATTENTION



Afin d'éviter tout risque de choc électrique, ne pas ouvrir l'appareil. Aucune pièce ne peut être changée par l'utilisateur. Contactez un SAV qualifié pour toute intervention.

Les symboles ci-dessous sont reconnus internationalement comme prévenant tout risque électrique.



Ce symbole indique que cette unité utilise un voltage élevé constituant un risque de choc électrique.



Ce symbole indique la présence d'instructions d'utilisation et de maintenance importantes dans le document fourni.

**REMARQUE:** Cet équipement a été testé et approuvé conforme aux limites pour un appareil numérique de classe B, conformément au chapitre 15 des règles de la FCC. Ces limites sont établis pour fournir une protection raisonnable contre tout risque d'interférences et peuvent provoquer une énergie de radiofréquence s'il n'est pas installé et utilisé conformément aux instructions, peut également provoquer des interférences aux niveaux des équipements de communication. Cependant, il n'existe aucune garantie que de telles interférences ne se produiront pas dans une installation particulière. Si cet équipement provoque des interférences en réception radio ou télévision, ceci peut être détecté en mettant l'équipement sous/hors tension, l'utilisateur est encouragé à essayer de corriger cette interférence par une ou plusieurs des mesures suivantes:

- Réorienter ou déplacer l'antenne de réception.
- Augmenter la distance entre l'équipement et le récepteur.
- Connecter l'équipement à une sortie sur un circuit différent de celui sur lequel le récepteur est branché.
- Consulter un revendeur ou un technicien radio / TV expérimenté.

**ATTENTION:** Les changements ou modifications non expressément approuvés par Rane Corporation peuvent annuler l'autorité de l'utilisateur à manipuler cet équipement et rendre ainsi nulles toutes les conditions de garantie.

CAN ICES-3 (B)/NMB-3(B)



Cartons et papier à recycler.

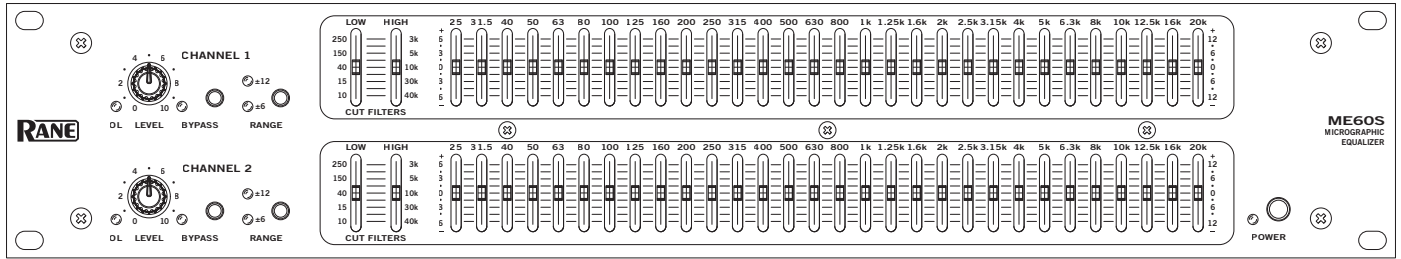

## Quick Start

Okay, know-it-all. So you don't need to read the manual. Well do your mother a favor and just read this section and you don't have to read anything else. Ever.

Hook-up is intuitive. Just follow the silkscreened instructions on the rear of the unit. All three Inputs are wired in parallel (they do *not* sum); and all three Outputs are wired in parallel. Use any *one* Input and any or all Outputs. Polarity convention is per IEC/ANSI/AES standards of pin 2 positive, pin 3 negative and pin 1 shield. The ME60S does not invert the signal.

Set the **LOW** and **HIGH CUT FILTER** controls as necessary to restrict bandwidth. Full frequency response results from positioning them all the way to the bottom.

Anyone familiar with other graphic equalizers finds the ME60S just as familiar. Setting curves is as easy as it is on all Rane graphics thanks to our innovative constant-Q circuitry. If you feel you want more information on setting up your curves, please see the back page.

There, now was that so bad?

## ME60S Connection

When first connecting the ME60S to other components, *leave the POWER switch off until the very last*. This gives you a chance to make mistakes and correct them without damaging your fragile speakers, ears and nerves.

### INPUTS

The 1/4" and XLR Inputs are wired in parallel and are actively balanced. Each works equally well. Choose strictly from a required hardware point-of-view. The XLR wiring convention adheres to American, British and International standards of pin 2 or tip being hot, pin 3 or ring being return, and pin 1 or sleeve being shield. It is not necessary to short any inputs to ground—it doesn't hurt, it's just not necessary. Use pin 1, or the shell, for shield ground. Unbalanced operation involves using only pin 2 or tip as signal, and pin 1 or sleeve as shield and ground.

### OUTPUTS

The Outputs mimic the Inputs. Balanced output requires using pin 2 or tip, and pin 3 or ring for the signal. It does not require pin 1 or shield. The signal exists differentially between the two balanced leads; ground is not involved. For hum-free systems ground is used only for shielding.

### EXPANDING

Expanding and/or daisy chaining the Inputs and Outputs normally uses the 1/4" jacks. Two parallel Input connectors allows driving a second signal processor or amplifier without special cabling.

### SIGNAL LEVELS

Signal levels from -10 dBV to +4 dBu are considered normal and within range (at least 20 dB of headroom exists above these levels). Do not directly connect microphones into the ME60S. These require a separate mic preamp.

## Front Panel Description

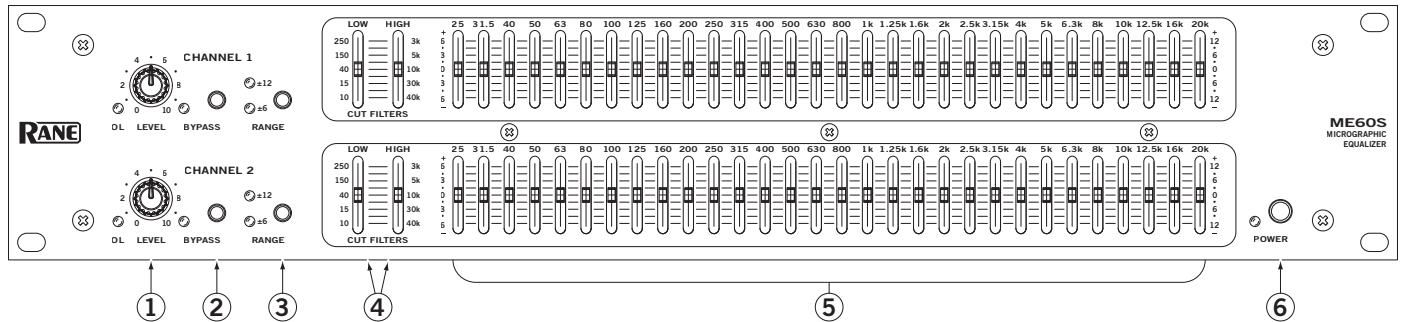

- ① **Channels 1 and 2 LEVEL controls** set the overall desired gain through the unit. The range is from Off to +8 dB for balanced use, or from Off to +2 dB with unbalanced inputs. Unity gain is at approximately “6” (balanced) or “7” (unbalanced). Using the highest setting (without lighting the Overload (OL) indicator) yields the best signal-to-noise performance. The OL indicator monitors all critical points for excessive signal levels. It lights whenever these levels exceed 3 dB below clipping. Occasional flickering is normal; however, if it glows steadily, reduce the signal coming from the source, or turn down the LEVEL control.
- ② **Channel BYPASS switches** activates the “hard-wire” bypass function. When engaged (red **BYPASS** LED *on*), all three pins of the input connectors directly connect to the same pins on the output connectors (hard-wired). Engaging this switch converts the ME60S into a relatively expensive patch cord, but one with pretty lights.
- ③ **Filter RANGE switch:** The gain range of the filter sliders is switchable (as a group) from  $\pm 6$  dB for high resolution, to  $\pm 12$  dB for maximum boost/cut capability.
- ④ **Channel LOW and HIGH CUT FILTER controls.** LOW CUT sets the corner frequency ( $-3$  dB point) for the low cut filter (high pass), adjustable from 10 Hz to 250 Hz. HIGH CUT sets the corner frequency ( $-3$  dB point) for the high cut filter (low pass), adjustable from 3 kHz to 40 kHz.
- ⑤ **Filter level controls** set the individual levels for each of the constant-Q filters. Their range is set by the RANGE switch ③. The grounded center-detent design ensures individual filters are off and bypassed when positioned to their centers.
- ⑥ **POWER switch & indicator** glows yellow any time this switch is closed and power is, in fact, actually flowing into the ME60S.

# Rear Panel Description

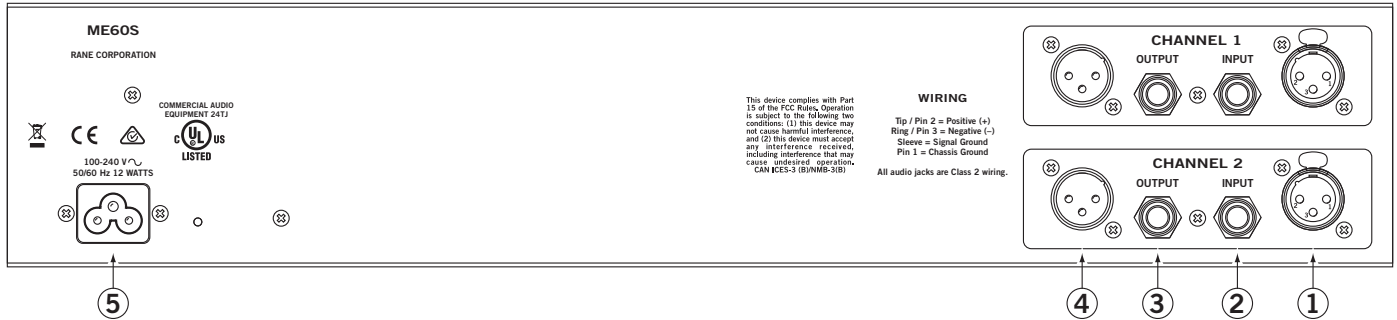

- ① **XLR INPUT connector.** Pin 2 is positive, pin 3 is negative and pin 1 is shield. For unbalanced operation, use pin 2 as hot and pin 1 as return. It is not necessary to connect pin 3.
- ② **1/4" INPUT connector.** This 1/4" tip-ring-sleeve (TRS) connector parallels the XLR connector described below. Tip is positive, ring is negative and sleeve is shield. Tip-sleeve (TS) cables will often work if the cables are short (under 10 feet [3 meters]). See the *Sound System Interconnection* RaneNote included with this manual for correct wiring.
- ③ **1/4" OUTPUT connector.** This 1/4" TRS connector parallels the XLR connector described below. As before, tip is hot, ring is cold and sleeve is shield.
- ④ **XLR OUTPUT connector.** Pin 2 is positive, pin 3 is negative and pin 1 is shield.
- ⑤ **POWER IEC jack** connects anywhere in the world to AC line voltage, 100-240 VAC.

## Important Note

### CHASSIS GROUNDING

If after hooking up your system it exhibits excessive hum or buzzing, there is an incompatibility in the grounding configuration between units somewhere. Your mission, should you accept it, is to discover how your particular system wants to be grounded. Here are some things to try:

1. If your equipment is in a rack, verify that all chassis are tied to a good earth ground, either through the line cord grounding pin or the rack screws to another grounded chassis.
2. Units with outboard power supplies do NOT ground the chassis through their line cords. Make sure these units are grounded either to another chassis which is earth grounded, or directly to the grounding screw on an AC outlet cover by means of a wire connected to a screw on the chassis with a star washer to guarantee proper contact.
3. See the *Sound System Interconnection* RaneNote included with this manual.

## Operating Instructions

Insuring the proper level of gain though the ME60S is just as important as adjusting the equalizer bands. Improper gain distribution is a common cause of loss of system headroom and less than optimum noise performance.

The OverLoad LED informs of an imminent or passed overload to the equalizer. Occasional blinking of the OL with program source material is fine, indicating optimized signal to noise performance of the ME60S. Run the ME60S with an input signal that is as hot as possible without the OL lighting more than occasionally.

The BYPASS switch allows comparison of equalized versus un-equalized signal. It is also useful in adjusting the level of the ME60S for unity gain or best signal-to-noise performance. The gain of the ME60S is optimized and at unity when there is no sound level difference between the bypassed and the active positions.

The overall gain range of the LEVEL control for the ME60S is off to +2 dB for unbalanced operation, or off to +8 dB for balanced operation. The level difference between the equalizer in Bypass or active can be significant. Adjust the LEVEL control so the signal level is the same between the bypassed and active positions of the BYPASS switch.

### GETTING STARTED

Here is one method of setting your equalizer that works well. Begin with the following settings:

1. Engage the **BYPASS** switch. (switch depressed, **BYPASS LED** on.)
2. Put all sliders in their center position (0 dB). The center position has a grounded detent.
3. Position the **CHANNEL LEVEL** controls about “7” for unbalanced operation and “6” for balanced operation.
4. Set **LOW** and **HIGH CUT** filters fully down, corresponding to 10 Hz and 40 kHz.
5. Apply a signal to the system.
6. Verify the **OL LED** is *not* on—occasionally blinking during extreme peaks indicates an optimal setting. But if it lights up a lot or lights steadily, lower the output level of the previous device in the signal chain.
7. Release the **BYPASS** switch and begin adjusting the equalizer filters.
8. During filter band adjustments, if the **OL LED** lights more than occasionally, turn down the output of the previous device in the signal chain.
9. Once all filter bands are adjusted to your liking, compare the signal loudness with the equalizer bypassed and active. Adjust the **LEVEL** controls on the ME60S so there is no difference between the levels of bypassed versus active.
10. The last step is to reconfirm that the **OL LED** lights only when there are large signal spikes in the program material, as in step 6 above.

For insight into how to use an equalizer, to alleviate acoustic problems or to adjust the overall tone of the program material, please read the next two sections.

### ACOUSTIC COMPENSATION

A graphic equalizer may be used to correct many acoustic problems. However, one should fully understand the ramifications of doing so. Acoustic problems are generally not consistent across the entire area of sound coverage. This is much more of a problem when setting up a sound system for large venues. In a typical large room or hall, there will be areas that have acoustic reinforcement problems and other areas where certain frequencies are almost entirely canceled out. Try to seek an acoustic remedy for acoustic problems whenever possible. When this is not possible or feasible, an equalizer may be used to compensate for an acoustic problem. But the problem is only improved at the point where the measurement is taken; other locations in the room may be adversely affected by the equalizer setting. For this reason, measure the acoustic response of the system from several locations and average the equalizer's setting. Doing this helps most locations in the venue to have an equal sound quality.

The best way to “see” what the acoustic signature of the room is doing to sound is to use a real time analyzer or any of the many computerized measurement systems. Using these devices to analyze the response of the room and the sound system is the only accurate means available for setting an equalizer properly.

Equalization can be like spice in the hands of a master chef. A little goes a long way in improving sound quality, too much and the mix is spoiled. If modest amounts of equalization (6-8 dB) do not solve the problem, it is best remedied by other means. Avoid adding large amounts of boost below 63 Hz, especially when using vented bass cabinets. Boosting frequencies below the vented enclosure's low frequency cutoff can easily cause over excursion of the speaker's cone, causing premature failure. In addition, boosting low frequencies can make your power amplifier run hotter, leading to premature amplifier failure.

When equalizer adjustment is completed, compare the un-equalized sound with the equalized sound by alternately engaging the BYPASS switch. Use familiar source material and walk around in the sound coverage area to insure that no anomalies have been introduced into the sound system. If it sounds good, you're done.

### TONE CONTOURING

If a ME60S is used for tone contouring by ear, be careful about adding upper bass (63 Hz to 200 Hz) as this can cause “muddiness” or loss of clear definition. (Also see the previous warning about boosting frequencies below 63 Hz.) Middle frequency problems usually express themselves by vocals having a nasal quality (too much mid band boost) or vocals not being easily understandable (usually caused by mid band frequencies being under represented in the overall sound). High frequency problems show as “sizzle”—not good, and is sometimes caused by too much high frequency boosting. This is most obvious with cymbals and hi-hats. To use the cooking metaphor, high frequencies should simmer, not sizzle.

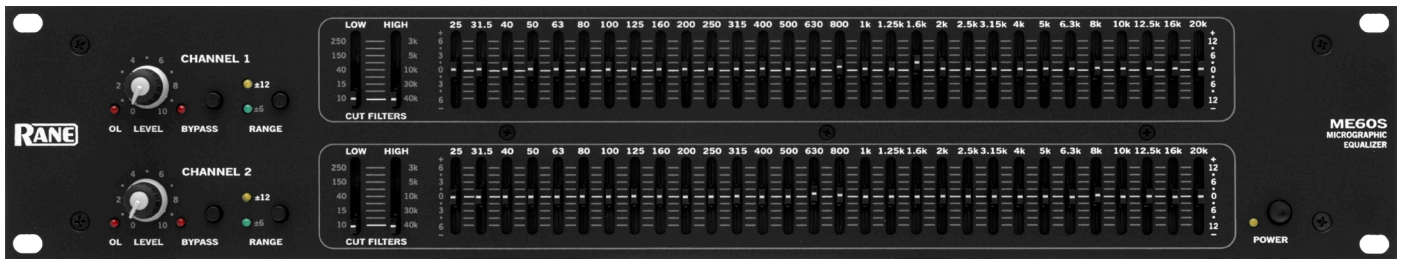

## General Description

The Rane ME60S Stereo Constant-Q Equalizer is a two-channel,  $\frac{1}{3}$ -octave design, housed in a two rack-space unit. It features a Range switch for high slider resolution in the  $\pm 6$  dB mode, equivalent resolution to 45 mm sliders found on larger models. The  $\pm 12$  dB mode provides a wide range of control over system audio.

The ME60S evolved by combining two ME 30 equalizers in one unit and then embellishing with two adjustable band-limiting filters on the low and high end. Though consuming only 12 watts of power, a Power switch is added to the ME60S (the ME 30S consumes 7 watts and does not have a Power switch).

The active filter sections feature Rane's innovative constant-Q (constant bandwidth) design. Constant-Q means the bandwidth of each individual filter is guaranteed to be narrow enough to prevent unwarranted interaction between filters, yet wide enough to produce exactly the type of correction curve demanded by even the most unusual acoustic surroundings. This differs dramatically from conventional designs of the past, encumbered with the unfortunate characteristic of changing bandwidth when changing boost/cut amounts.

## Features

- Constant-Q Bandwidth Design
- Overall Level Controls
- 20 mm Filter Slide Controls
- $\pm 6$  dB or  $\pm 12$  dB Slider Range
- Sweepable Low & High Cut Filters
- Passive Bypass Switches
- Grounded Center Detents at 0 dB
- Infrasonic, Ultrasonic, & RFI Filters
- Fully Balanced XLR Inputs and Outputs
- $\frac{1}{4}$ " TRS Balanced/Unbalanced Inputs and Outputs
- Universal internal switching power supply (100-240 VAC)

The adjustable filters are useful to band limit the audio signal. For instance, restricting high frequencies to match the incoming signal usually produces the most quiet system. And a common use for the Low Cut Filter is limiting the signal going to 70-volt speaker systems. Often low frequencies saturate the loudspeaker transformers. Restricting these signals greatly improves system intelligibility. Full bandwidth use requires positioning both sliders to their lower limits. This effectively removes the filters and guarantees 20-20 kHz  $\pm 0.5$  dB performance.

Front panel controls and indicators include an overall rotary Level control for each channel as well as Overload indicators. Passive pushbutton Bypass switches feature LED indicators, avoiding ambiguity by being *on* when the unit is Bypassed. (A *passive* Bypass switch requires no power to operate. This allows completion of the audio path should power fail in the ME60S.)

Inputs and Outputs are electronically balanced designs, capable of unbalanced operation when required. They accept and drive all possible signal levels into normal load impedances. Balanced applications choose between the XLR or  $\frac{1}{4}$ " Tip-Ring-Sleeve connectors. Unbalanced sources also may tie to the ME 60S through mono  $\frac{1}{4}$ " connectors (no ring connection).

**Features & Specifications**

Parameter	Specification	Limit	Units	Conditions/Comments
Equalizer:				
.....Channels	Two			
.....Bands	(2x30) 1/3-Octave ISO Spacing			From 25 Hz to 20 kHz
.....Type	Constant-Q			
.....Accuracy	3		%	Center frequency
.....Travel	20		mm	Positive grounded center detent
.....Range	±12 or ±6	1	dB	Switch selectable
Inputs:	Active Balanced/Unbalanced			
.....Connectors	XLR and 1/4" TRS			
.....Impedance	>20k Balanced	1%	Ω	
.....Maximum Level	+21	1	dBu	
Outputs:	Active Balanced/Unbalanced			
.....Connectors	XLR and 1/4" TRS			
.....Impedance	400 Balanced   200 Unbalanced	1%	Ω	
.....Maximum Level	+21 Balanced   +15 Unbalanced	1	dBu	2 kΩ
	+19 Balanced   +13 Unbalanced	1	dBu	600 Ω
Overall Gain Range	Off to +8 (Balanced Out)	min	dB	Sliders centered
RFI Filters	Yes			
Passive Bypass Switches	Yes			
Overload LED Threshold	4	1	dB	Below clipping
Low Cut Filter	10-250 Hz, 12 dB/octave	3%	Hz	Butterworth
High Cut Filter	3k-40 kHz, 12 dB/octave	3%	Hz	
Frequency Response	20-20 kHz	±0.5	dB	
	10-40 kHz	+0/-3	dB	
THD & Noise	0.008	.002	%	+4 dBu, 20-20 kHz
IM Distortion (SMPTE)	0.005	.003	%	60 Hz / 7 kHz, 4:1, +4 dBu
Signal-to-Noise Ratio	re +20 dBu   re +4 dBu			20 kHz noise BW; balanced out
	112   96	2	dB	Sliders centered, unity gain
Channel Separation	75	3	dB	1 kHz
Common Mode Rejection	46	1	dB	1 kHz
Maximum Power	12		W	
Universal Line Voltage	100-240 VAC, 50/60 Hz		VAC	12W
Unit: Conformity	CE, FCC, cULus			
Unit: Construction	All Steel			
.....Size	3.5" H x 19" W x 8.5" D (2U)			(8.9 cm x 48.3 cm x 21.6 cm)
.....Weight	9 lb			(4.1 kg)
Shipping:				
.....Size	4.25" x 20.3" x 13.75"			(10.8 cm x 52 cm x 35 cm)
.....Weight	12 lb			(5.0 kg)
<i>Note: 0 dBu=0.775 Vrms</i>				

### Block Diagram

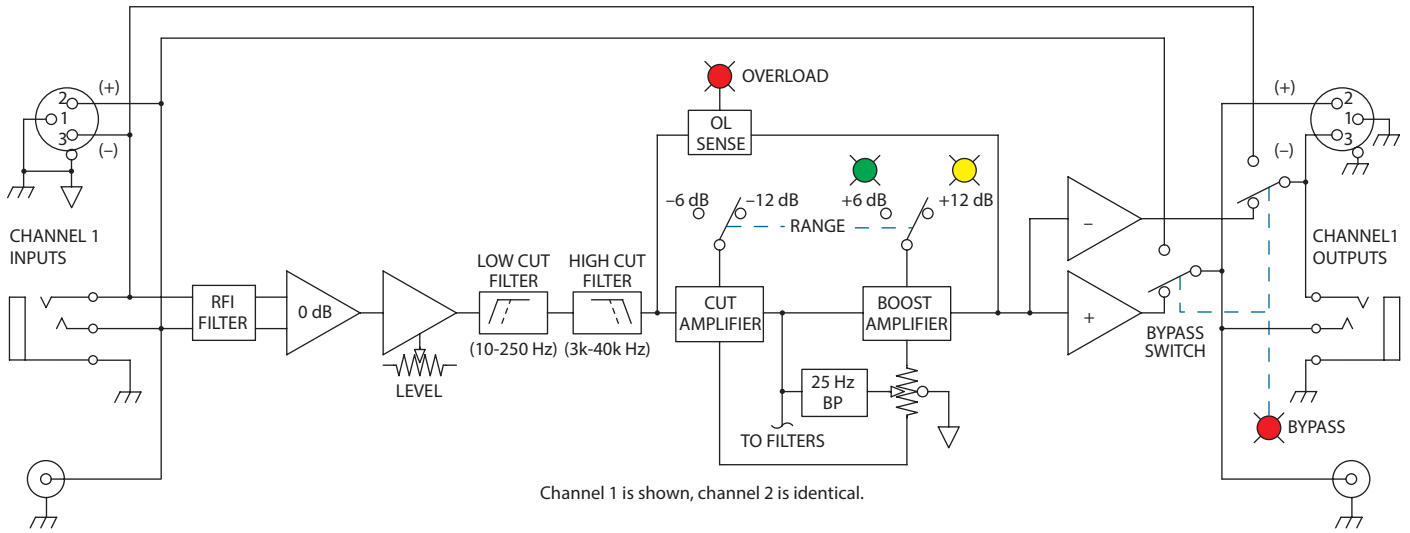

### Constant-Q

Constant-Q graphic equalizers arose from the sound professional's need for greater control with less interaction than previously possible with conventional equalizers. You use a constant-Q graphic the same way you use a conventional graphic. You just get the desired results quicker, with far less after adjustment to the adjacent sliders.

The accompanying figures dramatically show the advantages of constant-Q designs. For more technical information, consult the references on the next page. Most are available at [www.rane.com/library.html](http://www.rane.com/library.html).

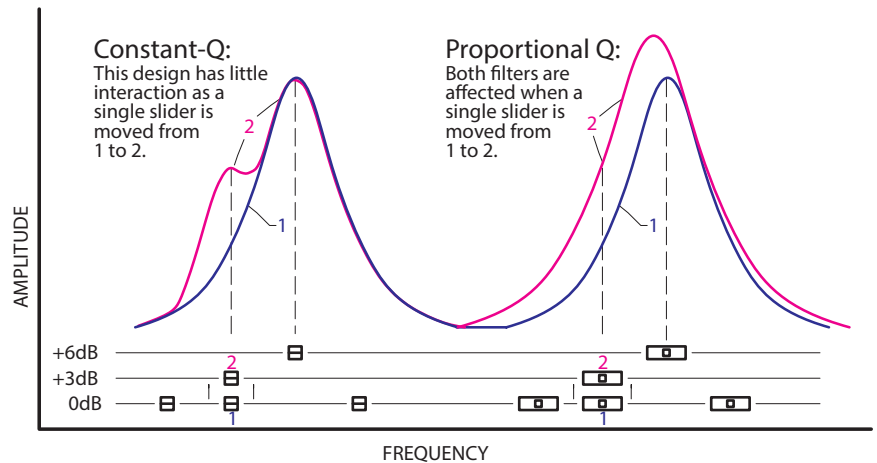
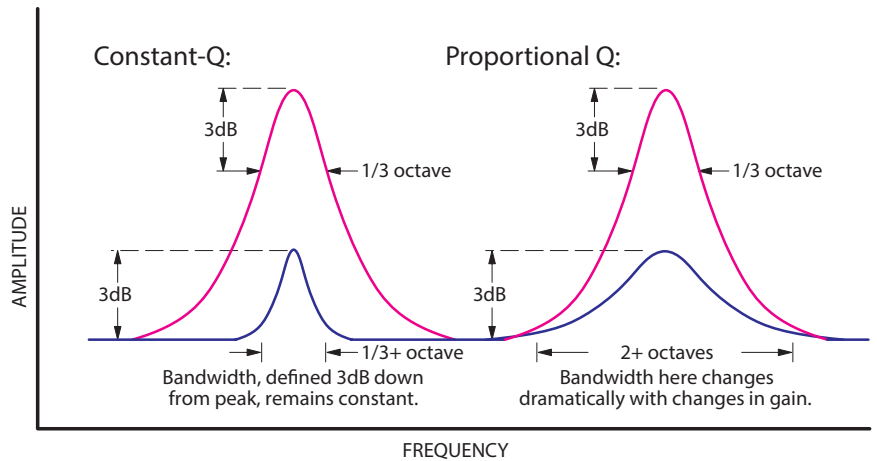

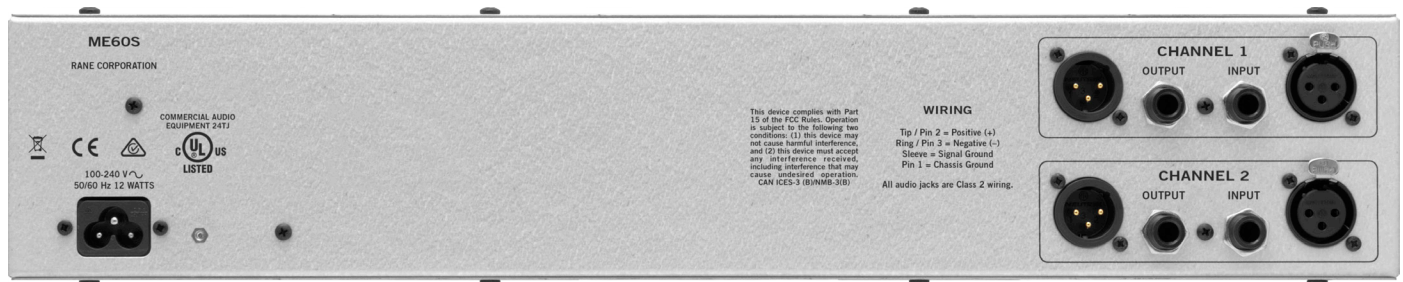
**Rear Panel****Architectural Specifications**

The graphic equalizer shall be a two channel model of constant-Q design to minimize interactions between adjacent bands, and shall occupy two rack spaces (2U). Each channel shall have thirty (30) frequency bands located on standard ISO center frequencies. Each band shall have a bandwidth of 1/3-octave. A switchable boost/cut range of 12 dB or 6 dB shall be provided. A detented and positively grounded 0 dB point shall be provided on 20 mm linear sliders with dust dams.

Low and high cut filters shall be provided with 12 dB/octave slopes and adjustable corner frequencies. A rotary overall level control shall be provided for each channel with a range from off to +8 dB of gain when used in balanced mode. The unit shall

provide a passive bypass feature for each channel requiring no power to operate. LED indicators shall be provided to indicate boost/cut range, overload and bypass conditions.

The inputs and outputs shall be active balanced/unbalanced designs terminated with XLR and 1/4" TRS (tip-ring-sleeve) connectors. RFI, infrasonic and ultrasonic filters shall be provided.

The unit shall incorporate a front panel power switch. The unit shall be capable of operation by means of its own built-in universal power supply operating at 100-240 VAC and meet CE requirements. The unit shall be UL and cUL listed. The unit shall be entirely constructed from cold-rolled steel.

*The unit shall be a Rane Corporation ME60S microGraphic Equalizer.*

**Available Accessories**

- SC 3.5 Security Cover

**References**

1. D. Bohn, "Constant-Q Graphic Equalizers," *RaneNote*, (1982).
2. D. Bohn, "A New Generation of Filters," *Sound and Video Contractor*, vol. 2, pp. 36-39 (Feb. 1984).
3. T. Pennington, "Constant-Q," *Studio Sound*, vol.27, pp. 82-85 (Oct. 1985).
4. D. Bohn, "Constant-Q Graphic Equalizers," *J. Audio Eng. Soc.*, vol. 34, pp. 611-626 (September 1986).
5. D. Bohn, "Exposing Equalizer Mythology," *RaneNote*, (1986).
6. D. Bohn, "Operater Adjustable Equalizers," *RaneNote*, (1990).

Most of these documents may be found at our website, [www.rane.com/library.html](http://www.rane.com/library.html)

## Sound System Interconnection

- **Cause & prevention of ground loops**
- **Interfacing balanced & unbalanced**
- **Proper pin connections and wiring**
- **Chassis ground vs. signal ground**
- **Ground lift switches**

**Rane Technical Staff**

**RaneNote 110**

© 1985, 1995, 2006, 2007, 2011 Rane Corporation

## Introduction

This note, originally written in 1985, continues to be one of our most useful references. It's popularity stems from the continual and perpetual difficulty of hooking up audio equipment without suffering through all sorts of bizarre noises, hums, buzzes, whistles, etc.— not to mention the extreme financial, physical and psychological price. As technology progresses it is inevitable that electronic equipment and its wiring should be subject to constant improvement. Many things *have* improved in the audio industry since 1985, but unfortunately wiring isn't one of them. However, finally the Audio Engineering Society (AES) has issued a standards document for interconnection of pro audio equipment. It is AES48, titled "*AES48-2005: AES standard on interconnections — Grounding and EMC practices — Shields of connectors in audio equipment containing active circuitry.*"

Rane's policy is to accommodate rather than dictate. However, this document contains suggestions for external wiring changes that should ideally only be implemented by trained technical personnel. Safety regulations require that all original grounding means provided from the factory be left intact for safe operation. No guarantee of responsibility for incidental or consequential damages can be provided. (*In other words, don't modify cables, or try your own version of grounding unless you really understand exactly what type of output and input you have to connect.*)

## Ground Loops

Almost all cases of noise can be traced directly to ground loops, grounding or lack thereof. It is important to understand the mechanism that causes grounding noise in order to effectively eliminate it. Each component of a sound system produces its own ground internally. This ground is usually called the audio *signal* ground. Connecting devices together with the interconnecting cables can tie the signal grounds of the two units together in one place through the conductors in the cable. Ground loops occur when the grounds of the two units are also tied together in another place: via the third wire in the line cord, by tying the metal chassis together through the rack rails, etc. These situations create a circuit through which current may flow in a closed “loop” from one unit’s ground out to a second unit and back to the first. It is not simply the presence of this current that creates the hum—it is when this current flows through a unit’s audio signal ground that creates the hum. In fact, even without a ground loop, a little noise current always flows through every interconnecting cable (i.e., it is impossible to eliminate these currents entirely). The mere presence of this ground loop current is no cause for alarm if your system uses properly implemented and *completely* balanced interconnects, which are excellent at rejecting ground loop and other noise currents. Balanced interconnect was developed to be immune to these noise currents, which can never be entirely eliminated. What makes a ground loop current annoying is when the audio signal is affected. Unfortunately, many manufacturers of balanced audio equipment design the internal grounding system

improperly, thus creating balanced equipment that is not immune to the cabling’s noise currents. This is one reason for the bad reputation sometimes given to balanced interconnect.

A second reason for balanced interconnect’s bad reputation comes from those who think connecting unbalanced equipment into “superior” balanced equipment should improve things. Sorry. Balanced interconnect is not compatible with unbalanced. The small physical nature and short cable runs of completely unbalanced systems (home audio) also contain these ground loop noise currents. However, the currents in unbalanced systems never get large enough to affect the audio to the point where it is a nuisance. Mixing balanced and unbalanced equipment, however, is an entirely different story, since balanced and unbalanced interconnect are truly *not compatible*. The rest of this note shows several recommended implementations for all of these interconnection schemes.

The potential or voltage which pushes these noise currents through the circuit is developed between the independent grounds of the two or more units in the system. The impedance of this circuit is low, and even though the voltage is low, the current is high, thanks to Mr. Ohm, without whose help we wouldn’t have these problems. It would take a very high resolution ohm meter to measure the impedance of the steel chassis or the rack rails. We’re talking thousandths of an ohm. So trying to measure this stuff won’t necessarily help you. We just thought we’d warn you.

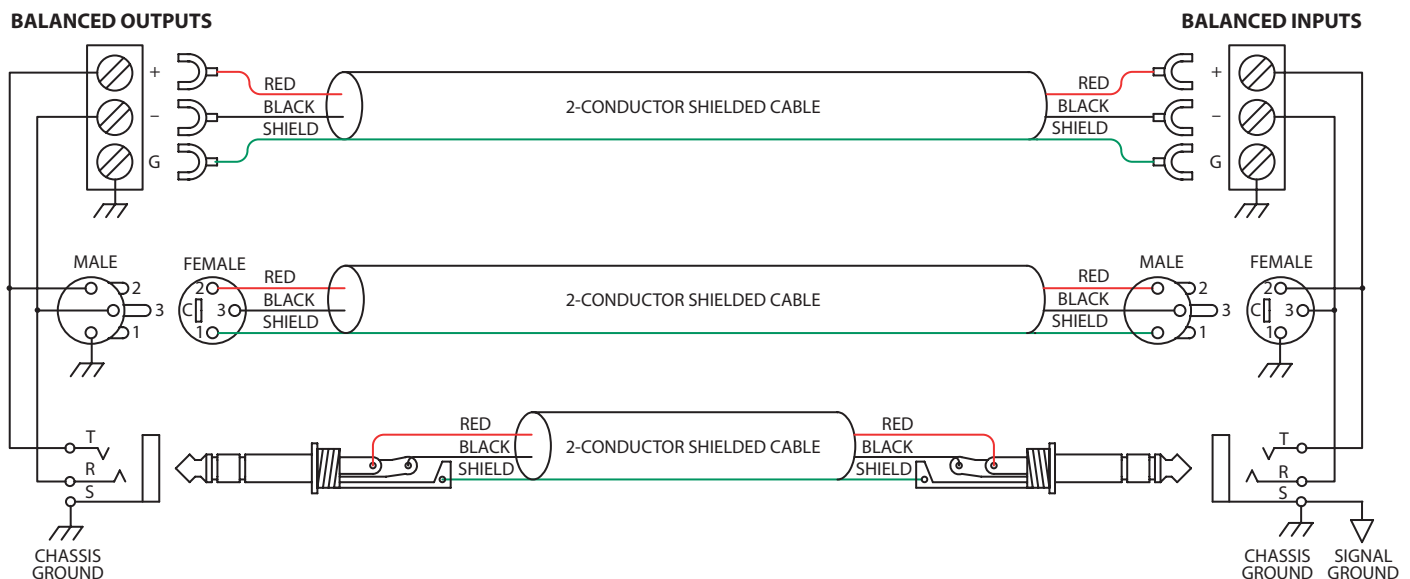

Figure 1a. The right way to do it.

## The Absolute Best Right Way To Do It

The method specified by AES48 is to use balanced lines and *tie the cable shield to the metal chassis (right where it enters the chassis) at both ends of the cable.*

A balanced line requires three separate conductors, two of which are signal (+ and -) and one shield (see Figure 1a). The shield serves to guard the sensitive audio lines from interference. Only by using balanced line interconnects can you *guarantee* (yes, *guarantee*) hum-free results. Always use twisted pair cable. Chassis tying the shield at each end also *guarantees* the best possible protection from RFI [radio frequency interference] and other noises [neon signs, lighting dimmers].

Neil Muncy<sup>1</sup>, an electroacoustic consultant and seasoned veteran of years of successful system design, chairs the AES Standards Committee (SC-05-05) working on this subject. He tirelessly tours the world giving seminars and dispensing information on how to successfully hook-up pro audio equipment<sup>2</sup>. He makes the simple point that it is absurd that you cannot go out and buy pro audio equipment from several different manufacturers, buy standard off-the-shelf cable assemblies, come home, hook it all up and have it work hum and noise free. *Plug and play.* Sadly, almost never is this the case, despite the science and rules of noise-free interconnect known and documented for over 60 years (see References for complete information).

It all boils down to using balanced lines, only balanced lines, and nothing but balanced lines. This is why they were developed. Further, that you *tie the shield to the chassis, at the point it enters the chassis, and at both ends of the cable* (more on 'both ends' later).

Since standard XLR cables come with their shields tied to pin 1 at each end (the shells are not tied, nor need be), this means equipment using 3-pin, XLR-type connectors *must tie pin 1 to the chassis* (usually called chassis ground) — not the audio signal ground as is most common.

### COMMON (WRONG) PRACTICE

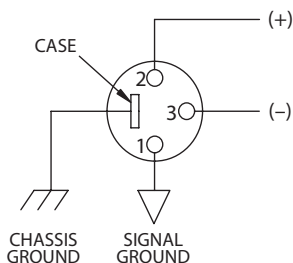

### RECOMMENDED PRACTICE

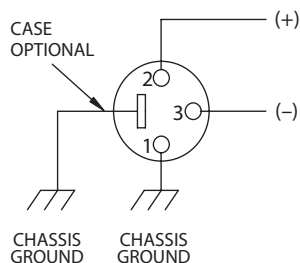

Figure 1b. Recommended practice.

Not using *signal ground* is the most radical departure from common pro-audio practice. Not that there is any argument about its validity. There isn't. **This is the right way to do it.** So why doesn't audio equipment come wired this way? Well, some does, and since 1993, more of it does. That's when Rane started manufacturing some of its products with balanced inputs and outputs tying pin 1 to chassis. So why doesn't everyone do it this way? Because life is messy, some things are hard to change, and there will always be equipment in use that was made before proper grounding practices were in effect.

Unbalanced equipment is another problem: it is everywhere, easily available and inexpensive. All those RCA and 1/4" TS connectors found on consumer equipment; effect-loops and insert-points on consoles; signal processing boxes; semi-pro digital and analog tape recorders; computer cards; mixing consoles; et cetera.

The next several pages give tips on how to successfully address hooking up unbalanced equipment. Unbalanced equipment when "blindly" connected with fully balanced units starts a pattern of hum and undesirable operation, requiring extra measures to correct the situation.

## The Next Best Right Way To Do It

The quickest, quietest and most foolproof method to connect balanced and unbalanced is to **transformer isolate all unbalanced connections.** See Figure 2.

Many manufacturers provide several tools for this task, including Rane. Consult your audio dealer to explore the options available.

The goal of these adaptors is to allow the use of *standard cables.* With these transformer isolation boxes, modification of cable assemblies is unnecessary. Virtually any two pieces of audio equipment can be successfully interfaced without risk of unwanted hum and noise.

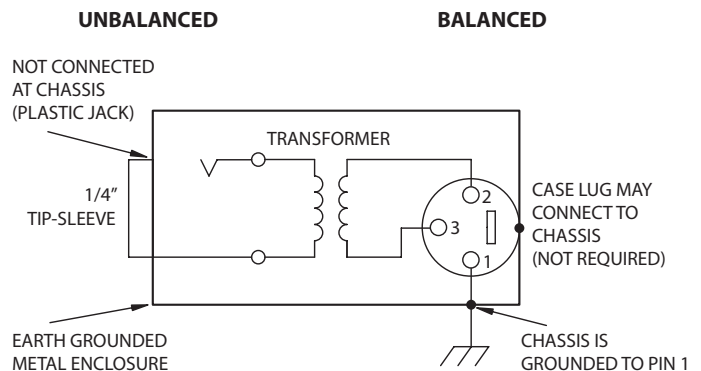

Figure 2. Transformer Isolation

Another way to create the necessary isolation is to use a *direct box*. Originally named for its use to convert the high impedance, high level output of an electric guitar to the low impedance, low level input of a recording console, it allowed the player to plug “directly” into the console. Now this term is commonly used to describe any box used to convert unbalanced lines to balanced lines.

### The Last Best Right Way To Do It

**If transformer isolation is not an option, special cable assemblies are a last resort.** The key here is to prevent the shield currents from flowing into a unit whose grounding scheme creates ground loops (hum) in the audio path (i.e., most audio equipment).

It is true that connecting both ends of the shield is theoretically the best way to interconnect equipment –though this assumes the interconnected equipment is internally grounded properly. Since most equipment is *not* internally grounded properly, connecting both ends of the shield is not often practiced, since doing so usually creates noisy interconnections.

A common solution to these noisy hum and buzz problems involves disconnecting one end of the shield, even though one can not buy off-the-shelf cables with the shield disconnected at one end. The best end to disconnect is the receiving end. If one end of the shield is disconnected, the noisy hum current stops flowing and away goes the hum — but only at low frequencies. A ground-sending-end-only shield connection minimizes the possibility of high frequency (radio) interference since it prevents the shield from acting as an antenna to the next input. Many reduce this potential RF interference by providing an RF path through a small capacitor (0.1 or 0.01 microfarad ceramic disc) connected from the lifted end of the shield to the chassis. (This is referred to as the “hybrid shield termination” where the sending end is bonded to the chassis and the receiving end is capacitively coupled. See Neutrik’s EMC-XLR for example.) The fact that many modern day installers still follow this one-end-only rule with consistent success indicates this and other acceptable solutions to

RF issues exist, though the increasing use of digital and wireless technology greatly increases the possibility of future RF problems.

If you’ve truly isolated your hum problem to a specific unit, chances are, even though the documentation indicates proper chassis grounded shields, the suspect unit is not internally grounded properly. Here is where special test cable assemblies, shown in Figure 3, really come in handy. These assemblies allow you to connect the shield to chassis ground *at the point of entry*, or to pin 1, or to lift one end of the shield. The task becomes more difficult when the unit you’ve isolated has multiple inputs and outputs. On a suspect unit with multiple cables, try various configurations on each connection to find out if special cable assemblies are needed at more than one point.

See Figure 4 for suggested cable assemblies for your particular interconnection needs. Find the appropriate output configuration (down the left side) and then match this with the correct input configuration (across the top of the page.) Then refer to the following pages for a recommended wiring diagram.

### Ground Lifts

Many units come equipped with ground lift switches. In only a few cases can it be shown that a ground lift switch improves ground related noise. (Has a ground lift switch ever *really* worked for you?) In reality, the presence of a ground lift switch greatly reduces a unit’s ability to be “properly” grounded and therefore immune to ground loop hums and buzzes. Ground lifts are simply another Band-Aid<sup>®</sup> to try in case of grounding problems. It is true that an entire system of properly grounded equipment, without ground lift switches, is guaranteed (yes *guaranteed*) to be hum free. The problem is most equipment is *not* (both internally and externally, AC system wise) grounded properly.

Most units with ground lifts are shipped so the unit is “grounded” — meaning the chassis is connected to audio signal ground. (This should be the best and is the “safest” position for a ground lift switch.) If after hooking up your system it exhibits excessive hum or

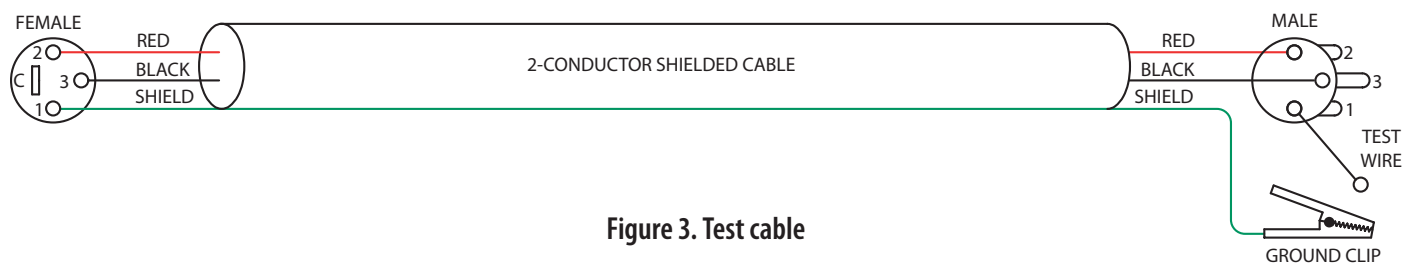

Figure 3. Test cable

buzzing, there is an incompatibility somewhere in the system's grounding configuration. In addition to these special cable assemblies that may help, here are some more things to try:

1. Try combinations of lifting grounds on units supplied with lift switches (or links). It is wise to do this with the power off!
2. If you have an entirely balanced system, verify all chassis are tied to a good earth ground, for safety's sake and hum protection. Completely unbalanced systems never earth ground anything (except cable TV, often a ground loop source). If you have a mixed balanced and unbalanced system, do yourself a favor and use isolation transformers or, if you can't do that, try the special cable assemblies described here and expect it to take many hours to get things quiet. May the Force be with you.
3. Balanced units with outboard power supplies (wall warts or "bumps" in the line cord) do *not* ground the chassis through the line cord. Make sure such units are solidly grounded by tying the chassis to an earth ground using a star washer for a reliable contact. (Rane always provides this chassis point as an external screw with a toothed washer.) Any device with a 3-prong AC plug, such as an amplifier, may serve as an earth ground point. Rack rails may or may not serve this purpose depending on screw locations and paint jobs.

### Floating, Pseudo, and Quasi-Balancing

During inspection, you may run across a ¼" output called floating unbalanced, sometimes also called pseudo-balanced or quasi-balanced. In this configuration, the sleeve of the output stage is not connected inside the unit and the ring is connected (usually through a small resistor) to the audio signal ground. This allows the tip and ring to "appear" as an equal impedance, not-quite balanced output stage, even though the output circuitry is unbalanced.

Floating unbalanced often works to drive either a balanced or unbalanced input, depending if a TS or TRS standard cable is plugged into it. When it hums, a special cable is required. See drawings #11 and #12, and do not make the cross-coupled modification of tying the ring and sleeve together.

### Winning the Wiring Wars

- Use balanced connections whenever possible, with the shield bonded to the metal chassis at both ends.
- Transformer isolate all unbalanced connections from balanced connections.
- Use special cable assemblies when unbalanced lines cannot be transformer isolated.
- Any unbalanced cable must be kept under 10 feet (3 m) in length. Lengths longer than this will amplify all the nasty side effects of unbalanced circuitry's ground loops.

### Summary







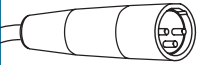
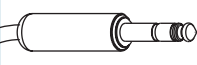
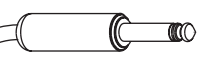
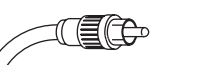

If you are unable to do things correctly (i.e. use fully balanced wiring with shields tied to the *chassis* at both ends, or transformer isolate all unbalanced signals from balanced signals) then there is no guarantee that a hum-free interconnect can be achieved, nor is there a definite scheme that will assure noise-free operation in all configurations.

### References

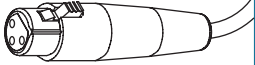
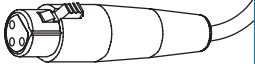
1. Neil A. Muncy, "Noise Susceptibility in Analog and Digital Signal Processing Systems," presented at the 97th AES Convention of Audio Engineering Society in San Francisco, CA, Nov. 1994.
2. *Grounding, Shielding, and Interconnections in Analog & Digital Signal Processing Systems: Understanding the Basics*; Workshops designed and presented by Neil Muncy and Cal Perkins, at the 97th AES Convention of Audio Engineering Society in San Francisco, CA, Nov. 1994.
3. The entire June 1995 AES Journal, Vol. 43, No. 6, available \$6 members, \$11 nonmembers from the Audio Engineering Society, 60 E. 42nd St., New York, NY, 10165-2520.
4. Phillip Giddings, *Audio System Design and Installation* (SAMS, Indiana, 1990).
5. Ralph Morrison, *Noise and Other Interfering Signals* (Wiley, New York, 1992).
6. Henry W. Ott, *Noise Reduction Techniques in Electronic Systems*, 2nd Edition (Wiley, New York, 1988).
7. Cal Perkins, "Measurement Techniques for Debugging Electronic Systems and Their Instrumentation," *The Proceedings of the 11th International AES Conference: Audio Test & Measurement*, Portland, OR, May 1992, pp. 82-92 (Audio Engineering Society, New York, 1992).
8. Macatee, *RaneNote*: "Grounding and Shielding Audio Devices," Rane Corporation, 1994.
9. Philip Giddings, "Grounding and Shielding for Sound and Video," *S&VC*, Sept. 20th, 1995.
10. AES48-2005: *AES standard on interconnections — Grounding and EMC practices — Shields of connectors in audio equipment containing active circuitry* (Audio Engineering Society, New York, 2005).

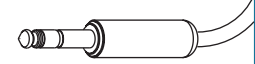
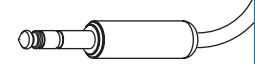
*Band-Aid* is a registered trademark of Johnson & Johnson

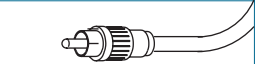
## To Input

From Output	<b>CABLE CONNECTORS</b>					
		MALE BALANCED XLR	¼" BALANCED TRS (TIP-RING-SLEEVE)	¼" OR 3.5mm UNBALANCED TS (TIP-SLEEVE)	UNBALANCED RCA	BALANCED EUROBLOCK
		<b>1</b>	<b>2</b>	<b>3<sub>B</sub></b>	<b>4<sub>B</sub></b>	+ to + - to - SHIELD NC
		<b>1</b>	<b>2</b>	<b>5</b>	<b>6</b>	+ to + - to - SHIELD NC
		<b>7</b>	<b>8</b>	<b>9<sub>B</sub></b>	<b>10<sub>B</sub></b>	+ to + - to - SHIELD ONLY TO EUROBLOCK
		<b>7</b>	<b>8</b>	<b>11</b>	<b>12</b>	+ to + - to - SHIELD NC
		<b>21<sub>A</sub></b>	<b>22<sub>A</sub></b>	<b>11</b>	<b>12</b>	+ to + - to - GROUND to GROUND
		<b>13</b>	<b>14</b>	<b>15<sub>A</sub></b>	<b>16<sub>A</sub></b>	<b>23</b>
		<b>17</b>	<b>18</b>	<b>19<sub>A</sub></b>	<b>20<sub>A</sub></b>	<b>23</b>
		+ to + - to - SHIELD ONLY TO XLR PIN 1	+ to + - to - SHIELD ONLY TO TRS SLEEVE	<b>24</b>	<b>24</b>	+ to + - to - GROUND to GROUND

**Figure 4. Interconnect chart for locating correct cable assemblies on the following pages.**

Note: (A) This configuration uses an "off-the-shelf" cable.

Note: (B) This configuration causes a 6 dB signal loss. Compensate by "turning the system up" 6 dB.

# From Output

# To Input

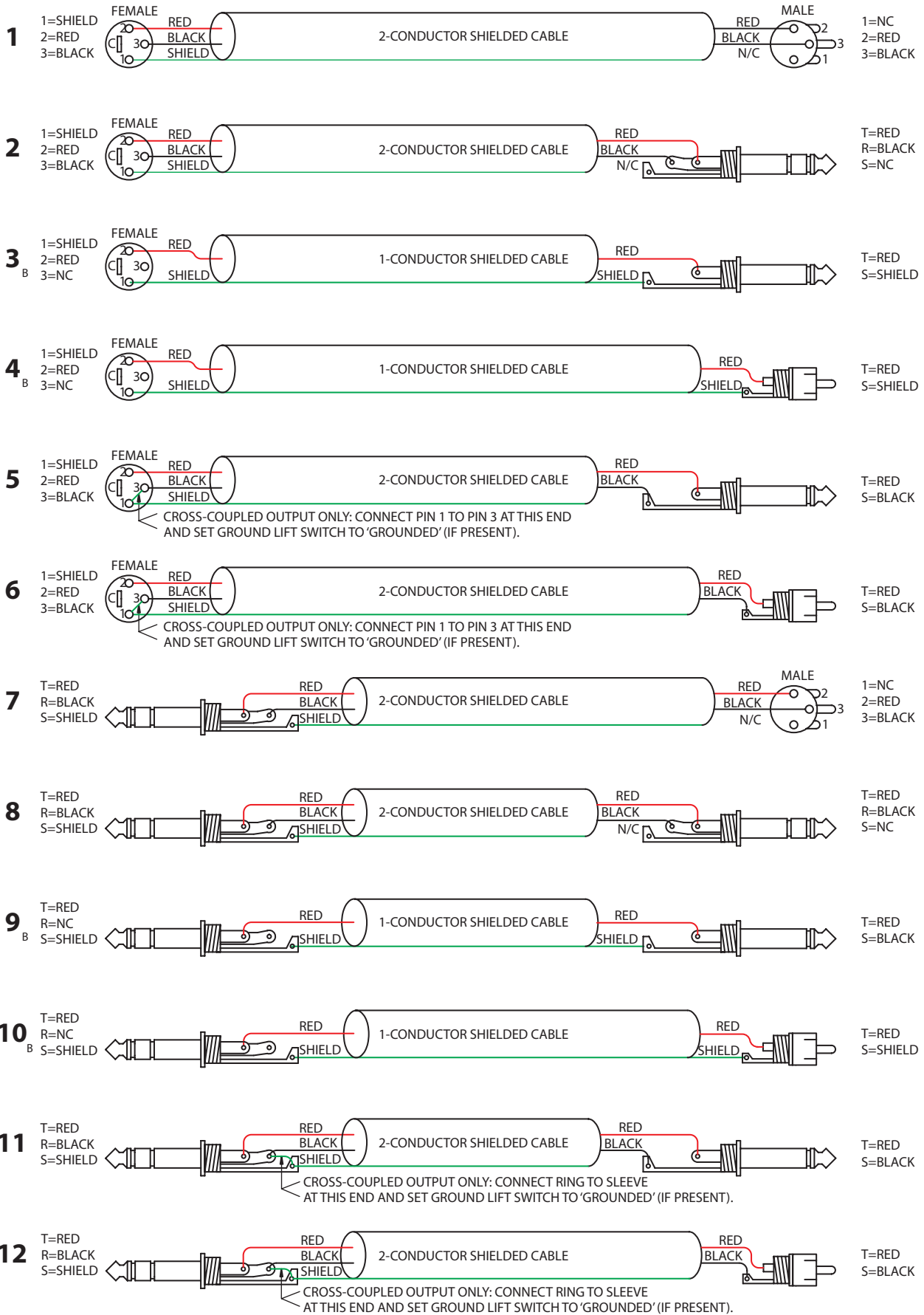

From Output

To Input

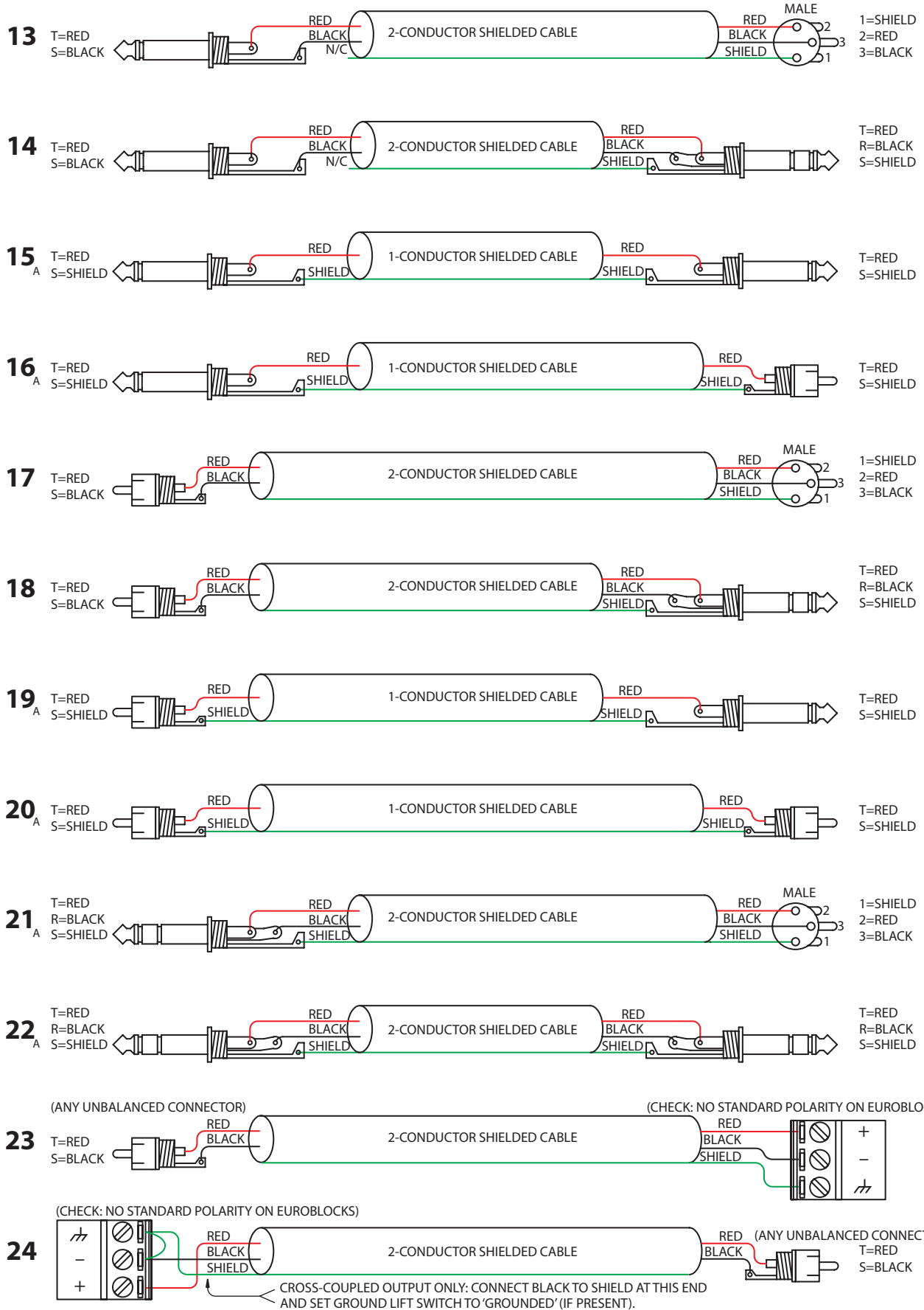

**RANE**



## FACTORY AUTHORIZED SERVICE

Your unit may be serviced by the Rane Factory or any Authorized Rane Service Center. To find a Service Center near you, please call the Rane factory, or check the Rane website. Please do not return your unit to Rane without prior authorization.

Rane Corporation

To obtain service or a Return Authorization, please phone 425-355-6000

or Fax 425-347-7757

The current list of U.S. Rane Authorized Service Centers is found on our website: [www.rane.com/service.html](http://www.rane.com/service.html)

## LIMITED DOMESTIC WARRANTY

RANE CORPORATION WARRANTS ALL RANE PRODUCTS (EXCEPT THOSE ITEMS CLASSIFIED AS *WEAR PARTS*, AND LISTED ON THE MANUAL-1 PAGE OF EACH OPERATORS MANUAL) PURCHASED IN THE USA AGAINST DEFECTS IN MATERIAL OR WORKMANSHIP FOR A PERIOD OF TWO (2) YEARS. *WEAR PARTS* ARE LIMITED TO A PERIOD OF NINETY (90) DAYS FROM THE INITIAL DATE OF RETAIL PURCHASE FROM AN AUTHORIZED RANE DEALER—*WEAR PARTS* REQUIRE PROOF OF PURCHASE DATE. This limited warranty extends to all purchasers or owners of the product during the warranty period beginning with the original retail purchase. Rane Corporation does not, however, warrant its products against any and all defects: 1) arising out of material or workmanship not provided or furnished by Rane, or 2) resulting from abnormal use of the product or use in violation of instructions, or 3) in products repaired or serviced by other than authorized Rane repair facilities, or 4) in products with removed or defaced serial numbers, or 5) in components or parts or products expressly warranted by another manufacturer. Rane agrees to supply all parts and labor to repair or replace defects covered by this limited warranty with parts or products of original or improved design, at its option in each respect, if the defective product is shipped prior to the end of the warranty period to any Rane authorized warranty repair facility in the U.S. or to the Rane factory in the original packaging or a replacement supplied by Rane, with all transportation costs and full insurance paid each way by the purchaser or owner.

### LIMITED WARRANTY OUTSIDE THE U.S.A.

RANE PRODUCTS ARE WARRANTED ONLY IN THE COUNTRY WHERE PURCHASED, THROUGH THE AUTHORIZED RANE DISTRIBUTOR IN THAT COUNTRY, AGAINST DEFECTS IN MATERIAL OR WORKMANSHIP, THE SPECIFIC PERIOD OF THIS LIMITED WARRANTY SHALL BE THAT WHICH IS DESCRIBED TO THE ORIGINAL RETAIL PURCHASER BY THE AUTHORIZED RANE DEALER OR DISTRIBUTOR AT THE TIME OF PURCHASE. Rane Corporation does not, however, warrant its products against any and all defects: 1) arising out of materials or workmanship not provided or furnished by Rane, or 2) resulting from abnormal use of the product or use in violation of instructions, or 3) in products repaired or serviced by other than authorized Rane repair facilities, or 4) in products with removed or defaced serial numbers, or 5) in components or parts or products expressly warranted by another manufacturer. Rane agrees, through the applicable authorized distributor, to repair or replace defects covered by this limited warranty with parts or products of original or improved design, at its option in each respect, if the defective product is shipped prior to the end of the warranty period to the designated authorized Rane warranty repair facility in the country where purchased, or to the Rane factory in the U.S., in the original packaging or a replacement supplied by Rane, with all transportation costs and full insurance paid each way by the purchaser or owner.

ALL REMEDIES AND THE MEASURE OF DAMAGES ARE LIMITED TO THE ABOVE SERVICES, IT IS POSSIBLE THAT ECONOMIC LOSS OR INJURY TO PERSON OR PROPERTY MAY RESULT FROM THE FAILURE OF THE PRODUCT; HOWEVER, EVEN IF RANE HAS BEEN ADVISED OF THIS POSSIBILITY, THIS LIMITED WARRANTY DOES NOT COVER ANY SUCH CONSEQUENTIAL OR INCIDENTAL DAMAGES. SOME STATES OR COUNTRIES DO NOT ALLOW THE LIMITATIONS OR EXCLUSION OF INCIDENTAL OR CONSEQUENTIAL DAMAGES, SO THE ABOVE LIMITATION MAY NOT APPLY TO YOU.

ANY AND ALL WARRANTIES, EXPRESS OR IMPLIED, ARISING BY LAW, COURSE OF DEALING, COURSE OF PERFORMANCE, USAGE OF TRADE, OR OTHERWISE, INCLUDING BUT NOT LIMITED TO IMPLIED WARRANTIES OF MERCHANTABILITY AND FITNESS FOR A PARTICULAR PURPOSE, ARE LIMITED TO A PERIOD OF TWO (2) YEARS FROM EITHER THE DATE OF ORIGINAL RETAIL PURCHASE OR, IN THE EVENT NO PROOF OF PURCHASE DATE IS AVAILABLE, THE DATE OF MANUFACTURE, SOME STATES OR COUNTRIES DO NOT ALLOW LIMITATIONS ON HOW LONG AN IMPLIED WARRANTY LASTS, SO THE ABOVE LIMITATIONS MAY NOT APPLY TO YOU. THIS LIMITED WARRANTY GIVES YOU SPECIFIC LEGAL RIGHTS, AND YOU MAY ALSO HAVE OTHER RIGHTS WHICH VARY FROM STATE TO STATE, COUNTRY TO COUNTRY.

## WARRANTY PROCEDURE - Only Valid in the USA

NOTICE! You must complete and return the warranty card or register your product online to extend the Warranty from 2 years to 3 years!

TO VALIDATE YOUR EXTENDED WARRANTY: Use the postcard that came in the box with your unit, or go to [www.rane.com](http://www.rane.com) and click on **New Product Registration**. Fill out the warranty completely, being sure to **include the model and serial number** of the unit since this is how warranties are tracked. If your Rane product was purchased in the USA, mail the completed card or register online with to Rane Corporation within 10 days from the date of purchase. **If you purchased the product outside the USA you must file your warranty registration with the Rane Distributor in that country.** It is advised that you keep your bill of sale as proof of purchase, should any difficulties arise concerning the registration of the warranty card. **NOTICE: IT IS NOT NECESSARY TO REGISTER IN ORDER TO RECEIVE RANE CORPORATION'S STANDARD TWO YEAR LIMITED WARRANTY.**

WARRANTY REGISTRATION is made and tracked by **model and serial numbers only**, not by the purchaser's or owner's name. Therefore any warranty correspondence or inquires **must** include the model and serial number of the product in question. Be sure to fill in the model and serial number in the space provided below and keep this in a safe place for future reference.

WARRANTY SERVICE MUST BE PERFORMED ONLY BY AN AUTHORIZED RANE SERVICE FACILITY LOCATED IN THE COUNTRY WHERE THE UNIT WAS PURCHASED, OR (if product was purchased in the USA) AT THE RANE FACTORY IN THE USA. If the product is being sent to Rane for repair, please call the factory for a Return Authorization number. We recommend advance notice be given to the repair facility to avoid possible needless shipment in case the problem can be solved over the phone. **UNAUTHORIZED SERVICE PERFORMED ON ANY RANE PRODUCT WILL VOID ITS EXISTING FACTORY WARRANTY.**

### FACTORY SERVICE

If you wish your Rane product to be serviced at the factory, **it must be shipped fully insured, in the original packing box or equivalent.** This warranty will **not** cover repairs on products damaged through improper packaging. If possible, avoid sending products through the mail. Be sure to include in the package:

1. Complete return street shipping address (P.O. Box numbers are **not** acceptable).
2. A detailed description of any problems experienced, including the make and model numbers of any other system equipment.
3. Remote power supply, if applicable.

Repaired products purchased in the U.S. will be returned prepaid freight via the same method they were sent to Rane. Products purchased in the USA, but sent to the factory from outside the USA **must** include return freight funds, and the sender is fully responsible for all customs procedures, duties, tariffs and deposits.

In order to qualify for Rane's one year extended warranty (for a total of 3 years parts and labor), the warranty must be completely filled out and sent to us immediately. Valid in USA only.

**We recommend you write your serial number here in your owners manual and on your sales receipt for your records.**

SERIAL NUMBER: \_\_\_\_\_ PURCHASE DATE: \_\_\_\_\_

# Declaration of Conformity

## Application of Council Directive(s):

2001/95/EC  
2002/96/EC  
2004/108/EC  
2006/95/EC  
2011/65/EU

## Standard(s) to which conformity is declared:

EN60065: 2002/A1:2006/A11:2008/A2:2010/A12:2011  
EN55103-1:2009  
EN55103-2:2009  
EN50581:2012  
ENVIRONMENT E2  
CE MARK FIRST AFFIXED IN 2007  
Serial Numbers 900000-999999

## Manufacturer:

**Rane Corporation**  
**10802 47th Avenue West**  
**Mukilteo WA 98275-5000 USA**

This equipment has been tested and found to be in compliance with all applicable standards and regulations applying to the EU's Low Voltage (LV) directive 2006/95/EC, and Electromagnetic Compatibility (EMC) directive 2004/108/EC. In order for the customer to maintain compliance with this regulation, high quality shielded cable must be used for interconnection to other equipment. Modification of the equipment, other than that expressly outlined by the manufacturer, is not allowed under this directive. The user of this equipment shall accept full responsibility for compliance with the LV directive and EMC directive in the event that the equipment is modified without written consent of the manufacturer. This declaration of conformity is issued under the sole responsibility of Rane Corporation.

## Type of Equipment: Professional Audio Signal Processing

**Brand:** Rane

**Model:** ME60S

## Immunity Results:

THD+N re: 4 dBu, 400 Hz, BW=20-20kHz

### Test Description

### Results

### Conditions

#### RF Electromagnetic Fields Immunity

80 MHz - 1000 MHz, 1 kHz AM, 80% depth, 3V/m

< -60 dB

80 MHz - 200 MHz

< -53 dB

200 MHz - 1000 MHz

#### Conducted RF Disturbances Immunity

150 kHz - 80 MHz, 1 kHz AM, 80% depth, 3V rms

< -84 dB

Power Lines

< -84 dB

Signal Lines

#### Magnetic Fields Immunity

50 Hz - 10 kHz, 4.0 - 0.4 A/m

< -88 dB

*I, the undersigned, hereby declare that the equipment specified above conforms to the Directive(s) and Standard(s) shown above.*

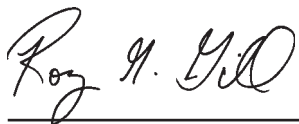

(Signature)

**Roy G. Gill**

(Full Name)

**Compliance Engineer**

(Position)

**January 12, 2007**

(Date)

**Mukilteo WA USA**

(Place)



# ME60S

microGRAPHIC EQUALIZER

